

LOW VOLTAGE VIDEO AMPLIFIER WITH LPF

■ GENERAL DESCRIPTION

The NJW1351 is a Low Voltage Video Amplifier with LPF circuit. By the internal charge pump circuit, output capacitor is unnecessary.

The NJW1351 features low power and small package, and is suitable for low power design on downsizing of portable video system and system with video output.

Moreover, the following voltage gain variations are arranged.

- NJW1350 (Gain=12dB)
- NJW1352 (Gain=9dB)
- NJW1353 (Gain=16dB)

■ PACKAGE OUTLINE



NJW1351RB1
MSOP8(TVSP8)



NJW1351KK1

■ FEATURES

- Operating Voltage 2.5 to 3.45V
- Output coupling capacitor-less
- 6dB amplifier
- Internal 75Ω Driver Circuit (2-system drive)
- 6th order LPF -38dB at 19MHz typ
- Power Save Circuit
- Bi-CMOS Technology
- Package Outline MSOP8(TVSP8)*, SON10

*MEET JEDEC MO-187-DA / THIN TYPE

■ PIN CONFIGURATION

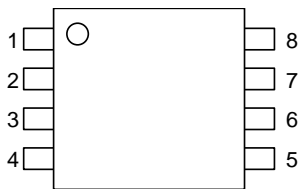

NJW1351RB1 (MSOP8)

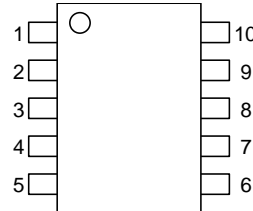

NJW1351KK1 (SON10)

■ BLOCK DIAGRAM

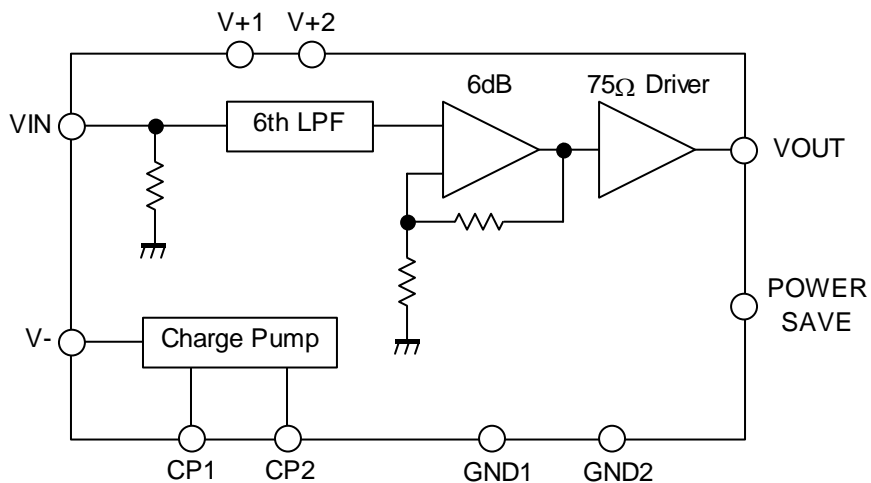

(NOTE)

TVSP8: V+1 and V+2 are the same pins, and GND1 and GND2 are the same pins.

NJW1351

■ ABSOLUTE MAXIMUM RATINGS (Ta=25°C)

PARAMETER	SYMBOL	RATINGS	UNIT
Supply Voltage	V ⁺	3.55	V
Power Dissipation	P _D	MSOP8(TVSP8):320 SON10:250	mW
Operating Temperature Range	Topr	-40 to +85	°C
Storage Temperature Range	Tstg	-55 to +125	°C

■ RECOMMENDED OPERATING CONDITION (Ta=25°C)

PARAMETER	SYMBOL	TEST CONDITION	MIN.	TYP.	MAX.	UNIT
Operating Voltage	Vopr		2.5	-	3.45	V

■ ELECTRICAL CHARACTERISTICS (V⁺=3.0V, R_L=150Ω, Ta=25°C)

PARAMETER	SYMBOL	TEST CONDITION	MIN.	TYP.	MAX.	UNIT
Operating Current	I _{CC}	No Signal	-	14.0	20.0	mA
Operating Current at Power Save	I _{save}	No Signal, Power Save Mode	-	0	1.0	μA
Maximum Output Voltage Swing	V _{om}	f=100kHz, THD=1%	4.5	5.2	-	V _{p-p}
Voltage Gain	G _v	V _{in} =100kHz, 1.0V _{p-p} , Input Sine Signal	6.0	6.4	6.8	dB
Low Pass Filter Characteristic	G _{fy} 4.5M	V _{in} =4.5MHz/100kHz, 1.0V _{p-p}	-0.75	-0.05	0.25	dB
	G _{fy} 8M	V _{in} =8MHz/100kHz, 1.0V _{p-p}	-7.0	-3.0	-1.0	
	G _{fy} 19M	V _{in} =19MHz/100kHz, 1.0V _{p-p}	-	-38	-23	
Differential Gain	DG	V _{in} =1.0V _{p-p} , 10step Video Signal	-	0.5	-	%
Differential Phase	DP	V _{in} =1.0V _{p-p} , 10step Video Signal	-	0.5	-	deg
S/N Ratio	SN _v	100kHz to 6MHz, V _{in} =1.0V _{p-p} 100% White Video Signal, R _L =75Ω	-	+70	-	dB
Switching Noise Level	N _{swpl}	R _L =75Ω, 10% White Video Signal input	-	4.0	7.0	mV _{pp}
2nd. Distortion	H _v	V _{in} =1.0V _{p-p} , Sine Signal , 3.58MHz, R _L =75Ω	-	-60	-	dB
SW Change Voltage High Level	V _{thPH}		1.25	-	V ⁺	V
SW Change Voltage Low Level	V _{thPL}		0	-	0.45	

■ CONTROL TERMINAL

PARAMETER	STATUS	NOTE
Power Save	H	Power Save: OFF
	L	Power Save: ON (Mute)
	OPEN	Power Save: ON (Mute)

■ TEST CIRCUIT

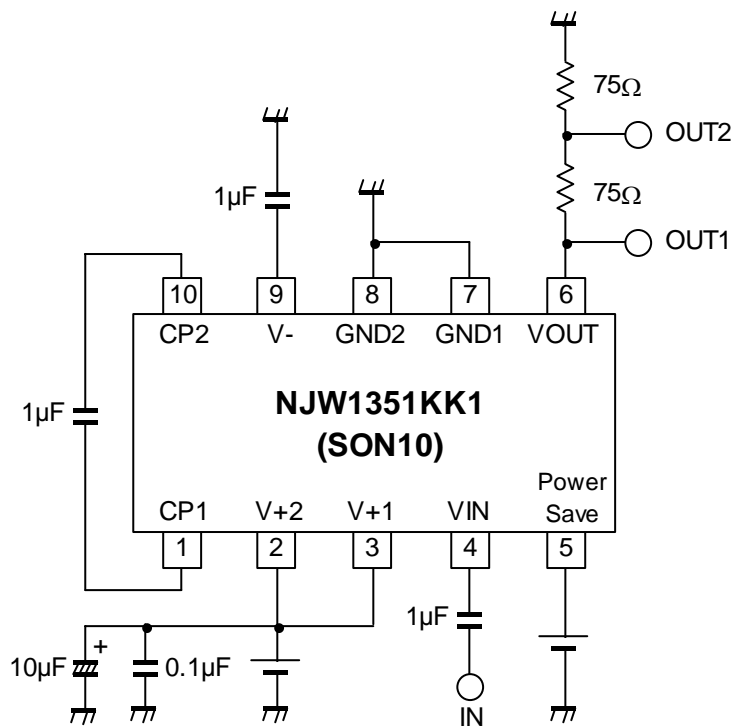
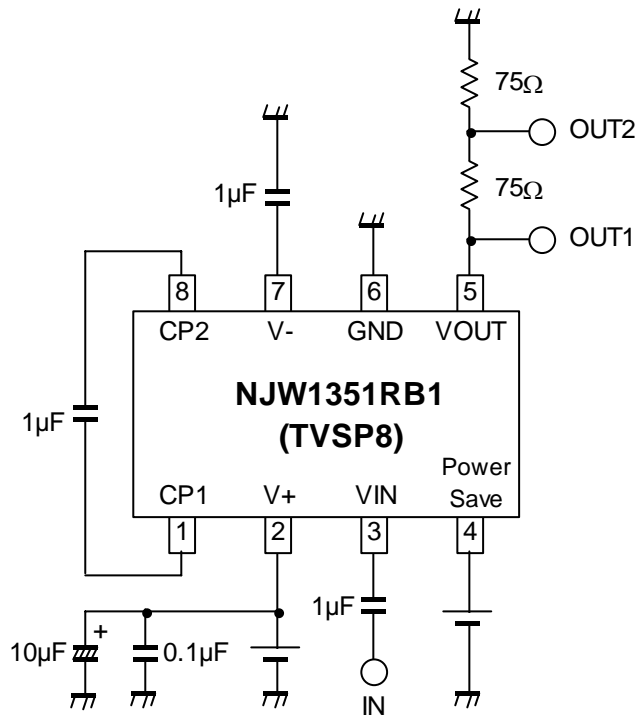

NJW1351

APPLICATION CIRCUIT (TVSP8) (1) Standard circuit

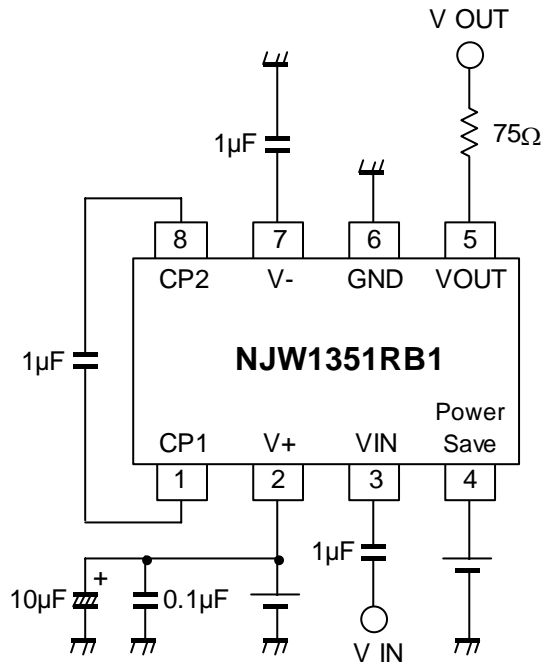

(2) Two-line driving circuit

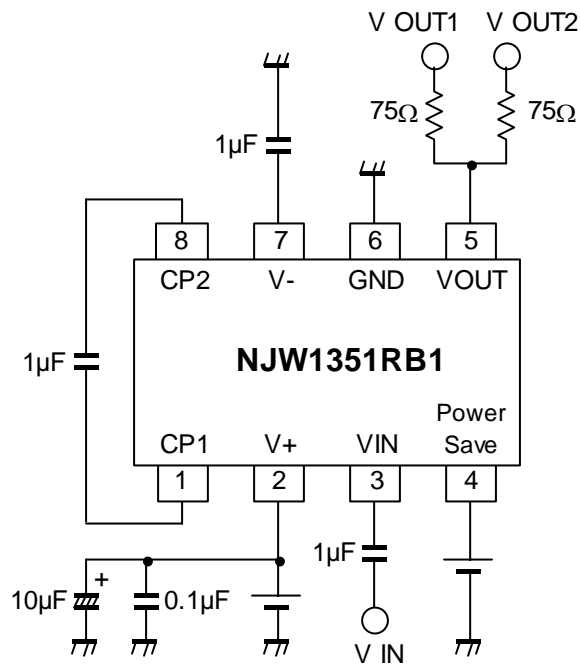

■ PIN FUNCTION (TVSP8)

PIN NO.	PIN NAME	INSIDE EQUIVALENT CIRCUIT
1	CP1	
2	V ⁺	-
3	V _{in}	
4	Power Save	
5	V _{out}	
6	GND	-
7	V ⁻	-
8	CP2	

■ PIN FUNCTION(SON10)

PIN NO.	PIN NAME	INSIDE EQUIVALENT CIRCUIT
1	CP1	
2,3	V+2,V+1	-
4	Vin	
5	Power Save	
6	Vout	
7,8	GND1,GND2	-
9	V-	-
10	CP2	

■ TYPICAL CHARACTERISTICS

Operating Current vs. Supply Voltage

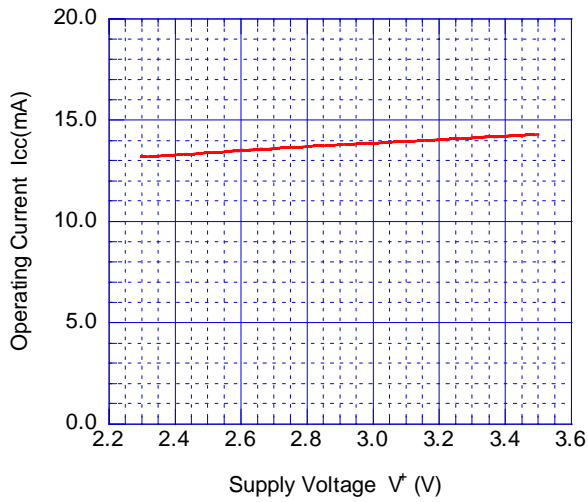

Operating Current at Standby State vs. Supply Voltage

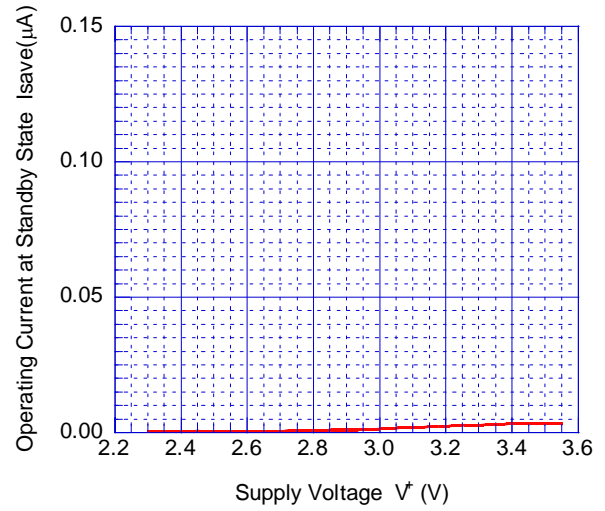

Maximum Output Voltage Swing vs. Supply Voltage

Total Harmonic Distortion=1%, 100kHz

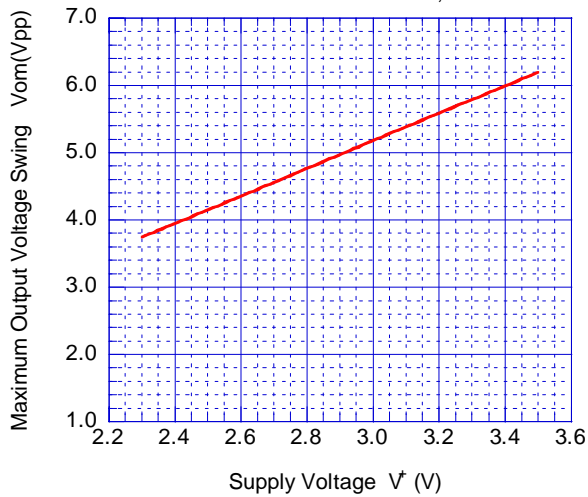

Voltage Gain vs. Supply Voltage

1.0Vpp, 100kHz sinewave signal input

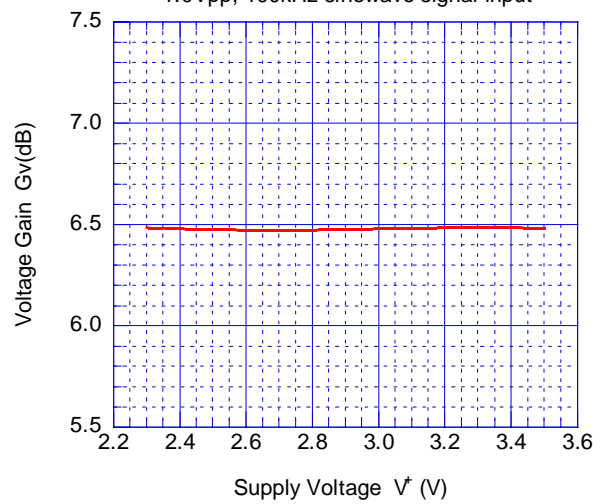

Low Pass Filter Characteristic 1 vs. Supply Voltage

1.0Vpp, 4.5MHz/100kHz

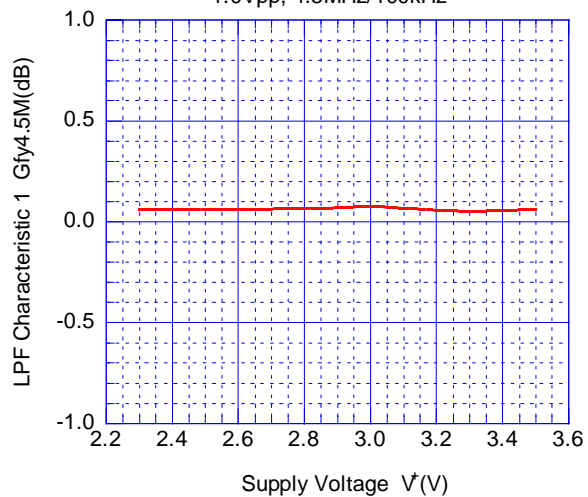

Low Pass Filter Characteristic 2 vs. Supply Voltage

1.0Vpp, 8MHz/100kHz

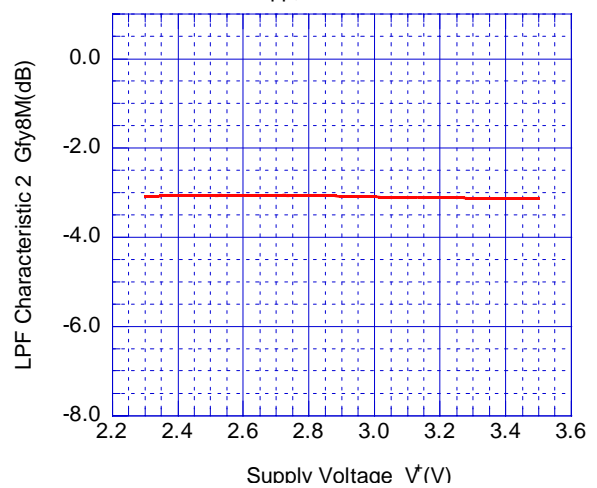

TYPICAL CHARACTERISTICS

Low Pass Filter Characteristic 3 vs. Supply Voltage
1.0Vpp, 19MHz/100kHz

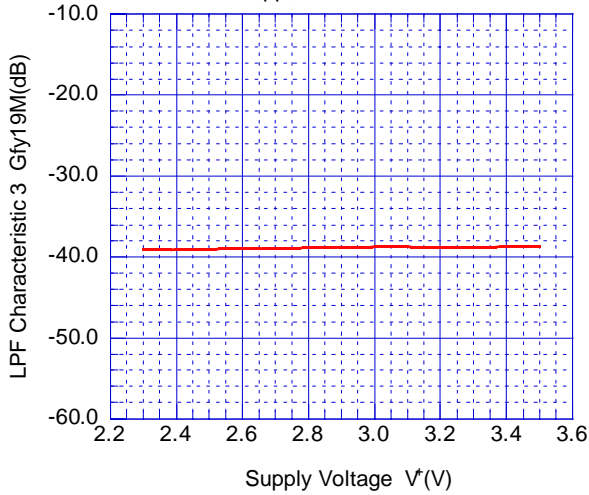

Low Pass Filter Characteristic vs. Supply Voltage
1.0Vpp, 23.5MHz/100kHz

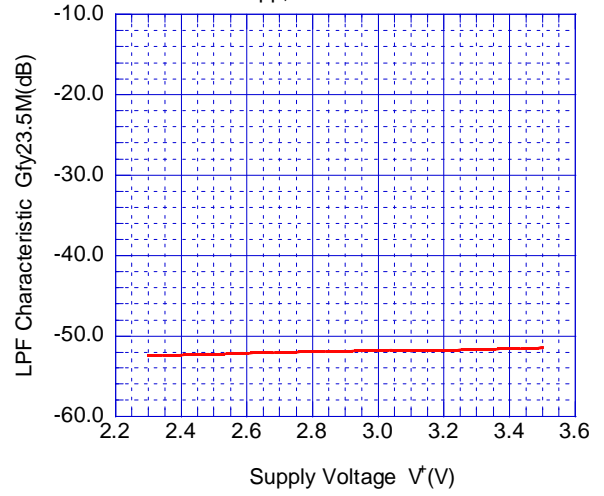

Differential Gain vs. Supply Voltage
1.0Vpp, 10step video signal input

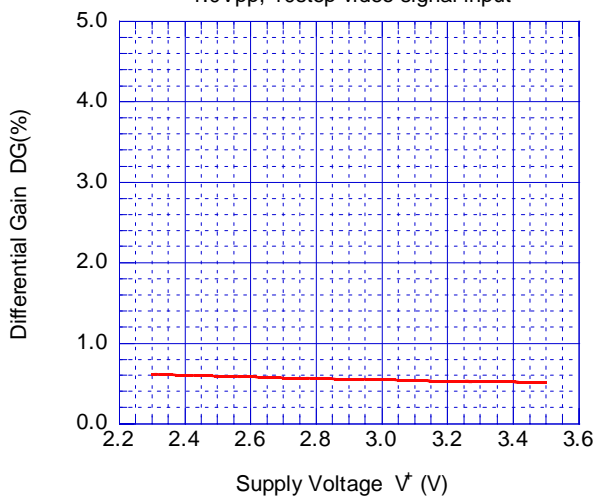

Differential Phase vs. Supply Voltage
1.0Vpp, 10step video signal input

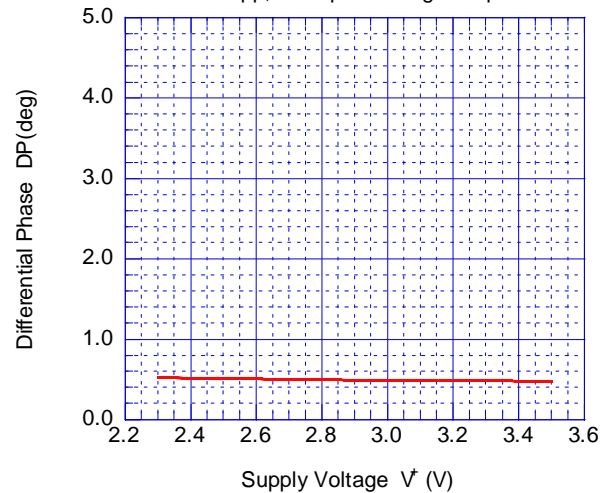

Signal to Noise Ratio vs. Supply Voltage
1.0Vpp, 100% white video signal input

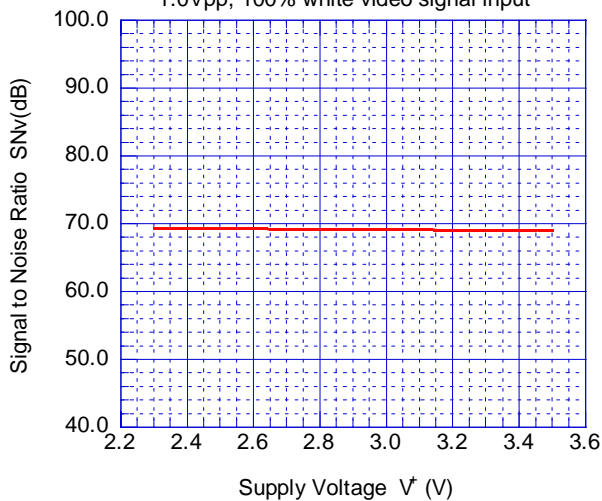

Switching Noise Level vs. Supply Voltage

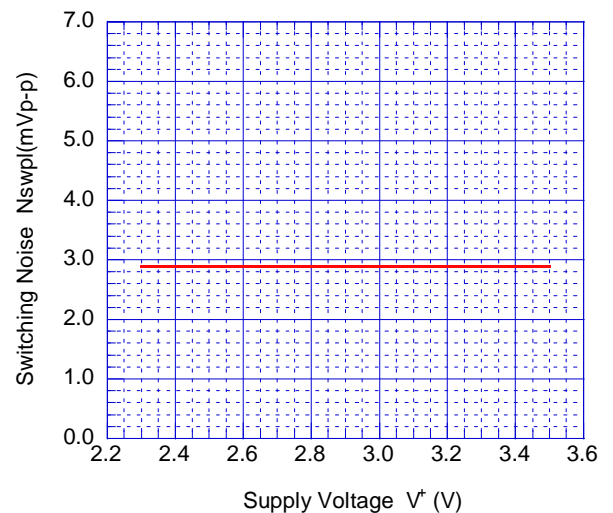

TYPICAL CHARACTERISTICS

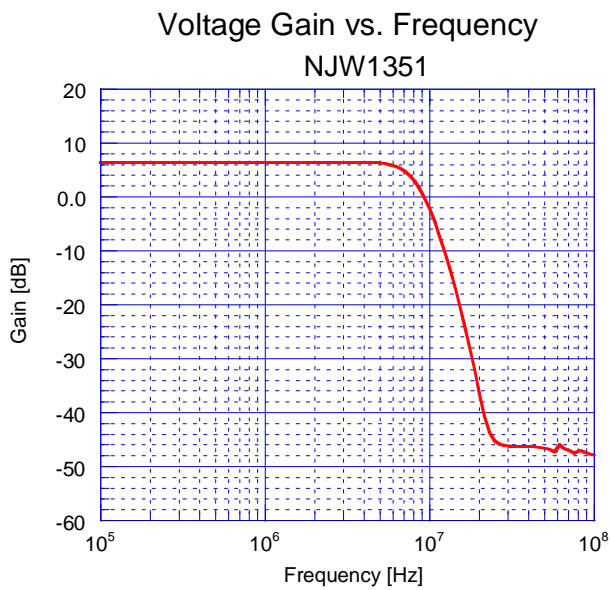
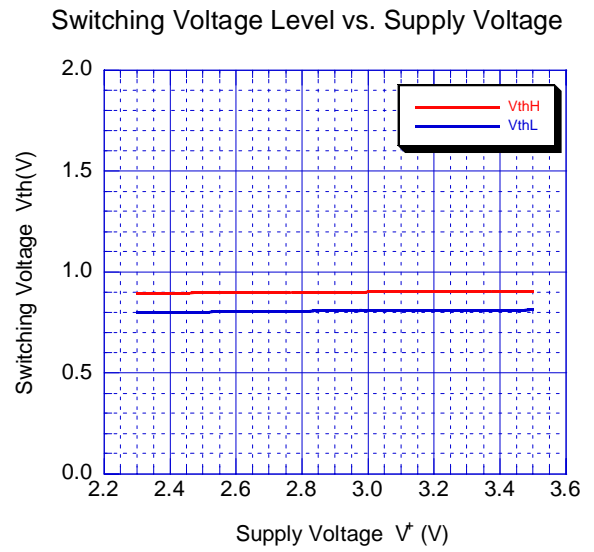
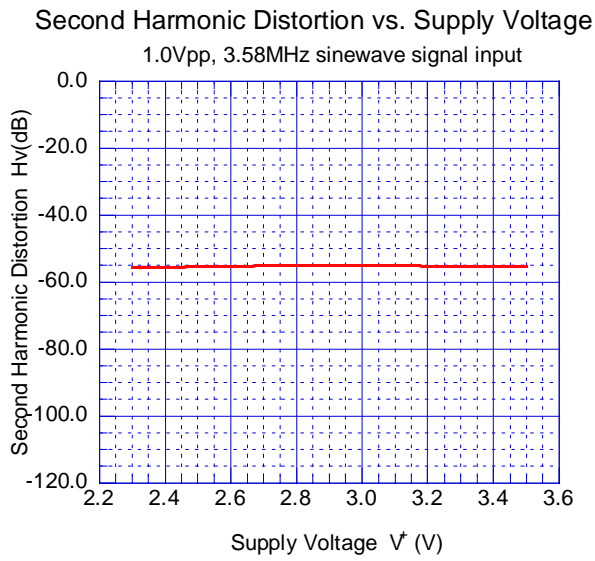

TYPICAL CHARACTERISTICS

Operating Current vs. Temperature

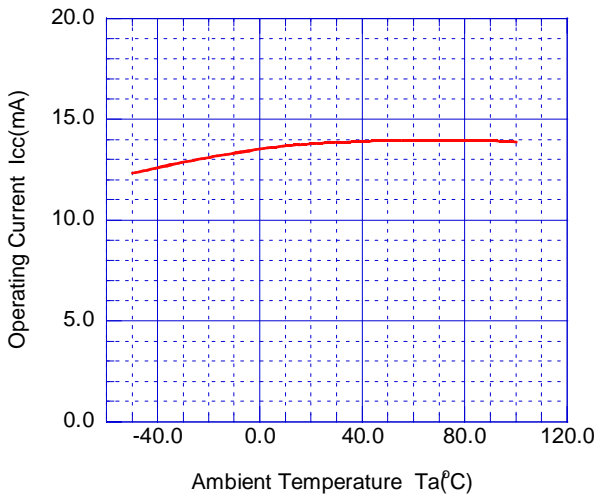

Operating Current at Standby State vs. Temperature

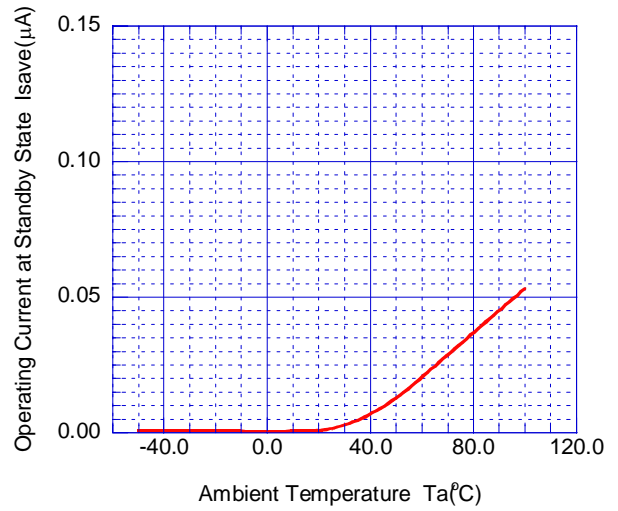

Maximum Output Voltage Swing vs. Temperature
Total Harmonic Distortion=1%, 100kHz

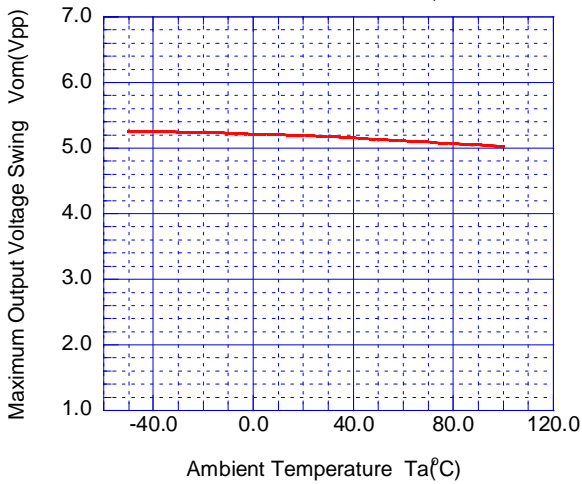

Voltage Gain vs. Temperature
1.0Vpp, 100kHz sinewave signal input

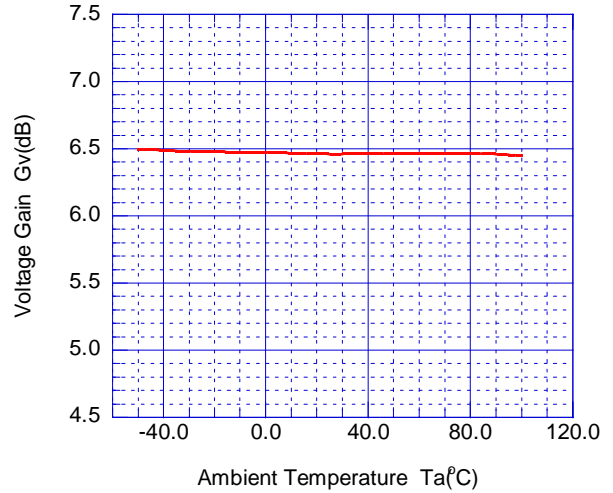

Low Pass Filter Characteristic 1 vs. Temperature
1.0Vpp, 4.5MHz/100kHz

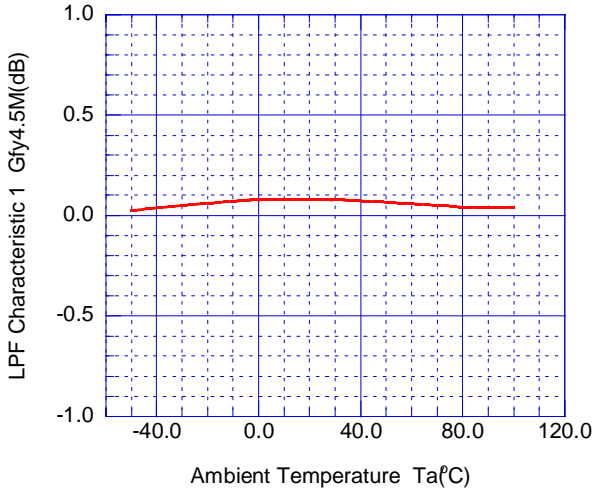

Low Pass Filter Characteristic 2 vs. Temperature
1.0Vpp, 8MHz/100kHz

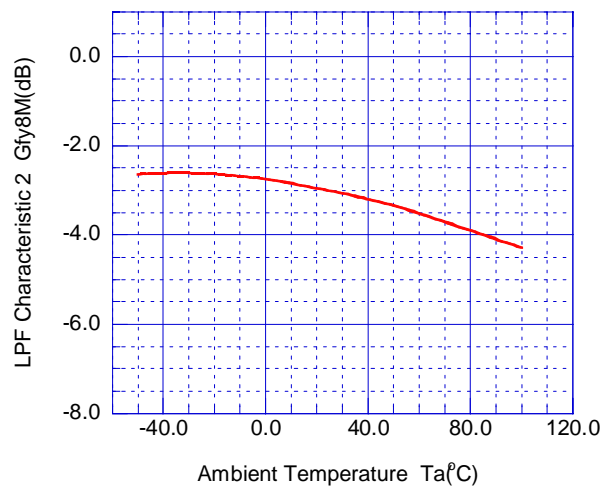

TYPICAL CHARACTERISTICS

Low Pass Filter Characteristic 3 vs. Temperature

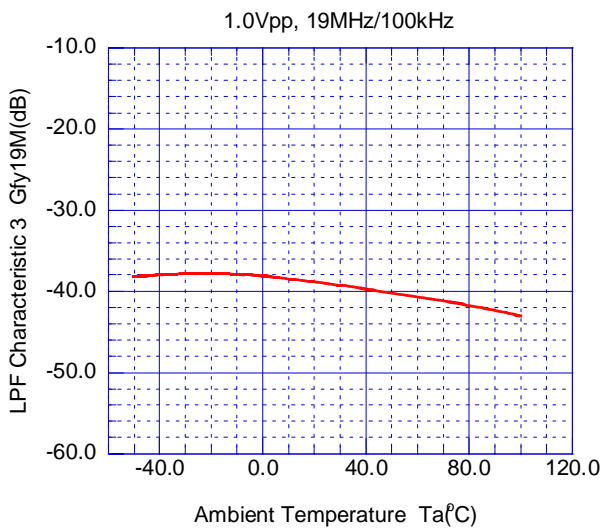

Differential Gain vs. Temperature

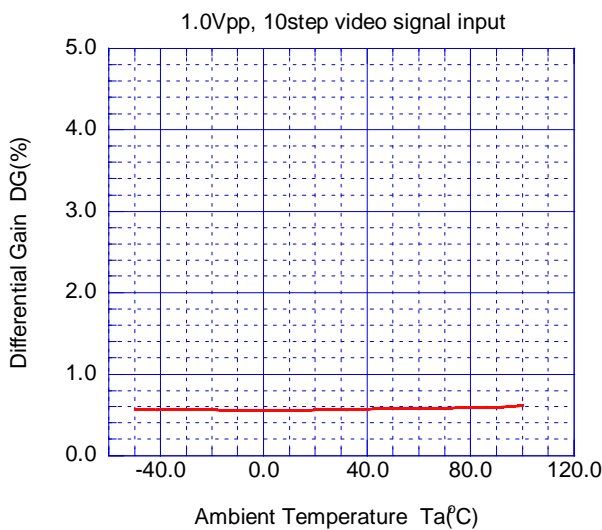

Differential Phase vs. Temperature

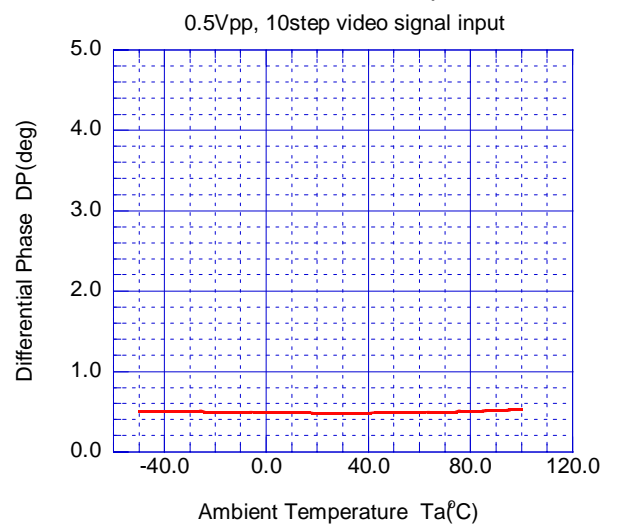

Signal to Noise Ratio vs. Temperature

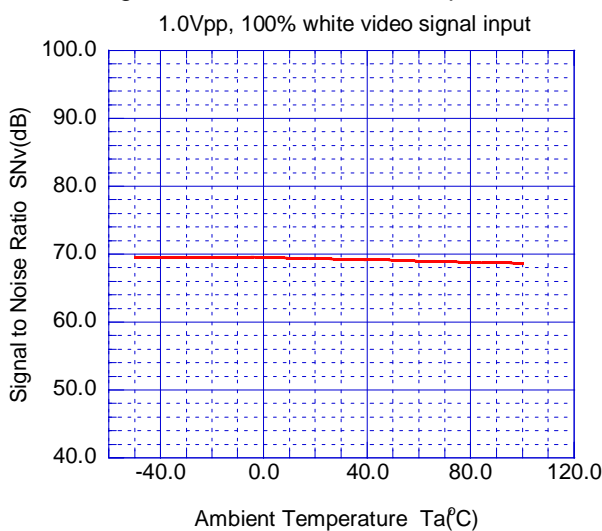

Switching Noise Level vs. Temperature

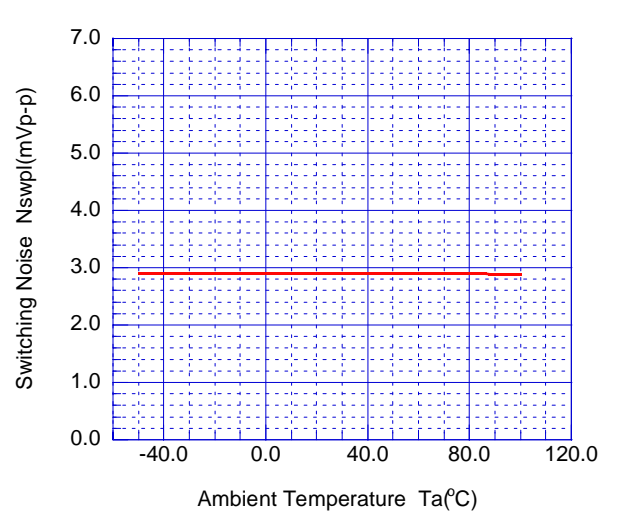

TYPICAL CHARACTERISTICS

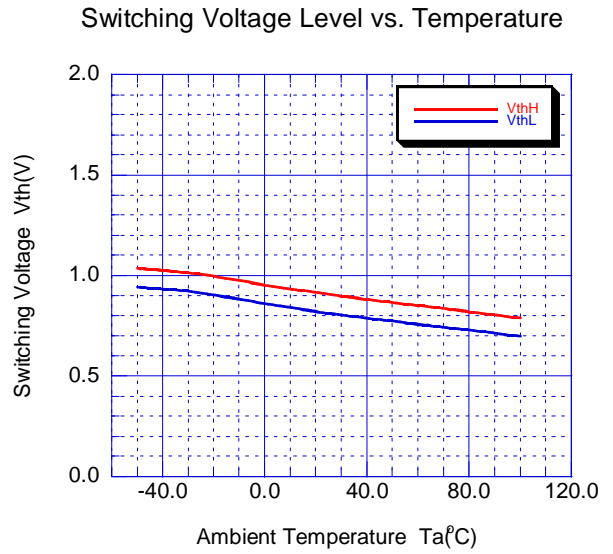
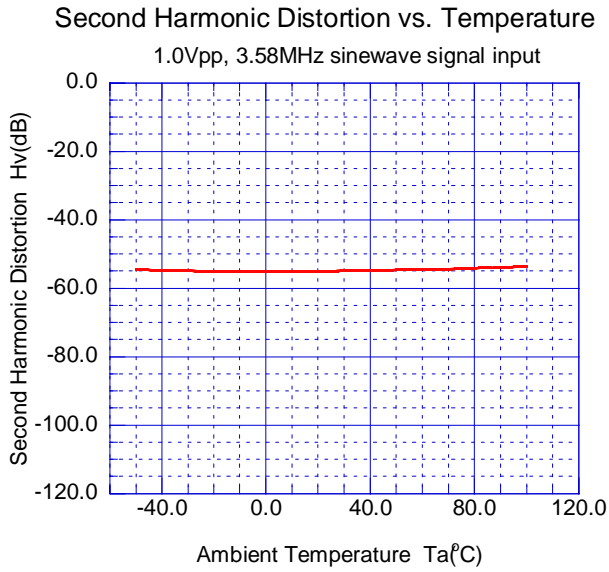

[CAUTION]
The specifications on this databook are only given for information, without any guarantee as regards either mistakes or omissions. The application circuits in this databook are described only to show representative usages of the product and not intended for the guarantee or permission of any right including the industrial rights.

Mouser Electronics

Authorized Distributor

Click to View Pricing, Inventory, Delivery & Lifecycle Information:

[NJR:](#)

[NJW1351RB1-TE1](#) [NJW1351RB1-TE2](#) [NJW1351KK1-TE3](#)

Данный компонент на территории Российской Федерации

Вы можете приобрести в компании MosChip.

Для оперативного оформления запроса Вам необходимо перейти по данной ссылке:

<http://moschip.ru/get-element>

Вы можете разместить у нас заказ для любого Вашего проекта, будь то серийное производство или разработка единичного прибора.

В нашем ассортименте представлены ведущие мировые производители активных и пассивных электронных компонентов.

Нашей специализацией является поставка электронной компонентной базы двойного назначения, продукции таких производителей как XILINX, Intel (ex.ALTERA), Vicor, Microchip, Texas Instruments, Analog Devices, Mini-Circuits, Amphenol, Glenair.

Сотрудничество с глобальными дистрибьюторами электронных компонентов, предоставляет возможность заказывать и получать с международных складов практически любой перечень компонентов в оптимальные для Вас сроки.

На всех этапах разработки и производства наши партнеры могут получить квалифицированную поддержку опытных инженеров.

Система менеджмента качества компании отвечает требованиям в соответствии с ГОСТ Р ИСО 9001, ГОСТ РВ 0015-002 и ЭС РД 009

Офис по работе с юридическими лицами:

105318, г.Москва, ул.Щербаковская д.3, офис 1107, 1118, ДЦ «Щербаковский»

Телефон: +7 495 668-12-70 (многоканальный)

Факс: +7 495 668-12-70 (доб.304)

E-mail: info@moschip.ru

Skype отдела продаж:

moschip.ru

moschip.ru_4

moschip.ru_6

moschip.ru_9