

ASI QUINT 100-240/2.4 EFD

Primary-Switched Power Supply for Supplying AS-Interface Systems

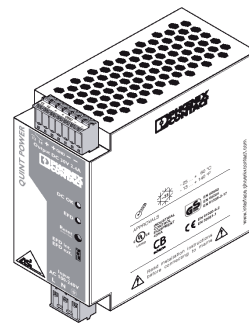

Data Sheet

01/2005

Short Description

One Cable – Two Functions

AS-Interface (AS-i) enables maximum control potential with its simplified installation technique.

Information and power supply are transmitted at the same time via a two-wire cable to minimize connection points.

AS-i power supply units use an integrated filter to ensure that the modulated data flow is not affected.

In addition to this, the short-circuit and idling-proof voltage output provides a current reserve of approximately 60%. This means that even loads with high inrush currents can be started safely.

Safety Through Automatic Ground Fault Detection

If two ground faults occur in an AS-i system, this can cause an unauthorized machine startup or mean that the machine can no longer be stopped.

To prevent this from happening, AS-i power supply units from Phoenix Contact indicate the first ground fault as it occurs. The message is indicated by the LEDs on the device and reported via an output.

In the default configuration, the signal of the message output can be used to stop the system via the control program or the PLC.

There is also the option of configuring the AS-i power supply unit so that the AS-i power is switched off automatically when a ground fault is detected. This prevents potential danger to operating personnel and machines/systems before it happens.

Global Use

The wide range input, which can be used to operate the AS-i power supply units from Phoenix Contact with all popular single-phase AC and DC networks, provides the starting point for global use.

Integrated Harmonic Filter

EN 61000-3-2 came into force on January 1, 2001. As from this date, all primary-switched power supplies that are directly connected to the public low-voltage network must be equipped with a harmonic filter to suppress the supply of high-frequency reverse currents in the power supply company network.

All AS-i power supply units from Phoenix Contact are equipped with an active PFC filter (**P**ower **F**actor **C**orrection). In addition to the filter function, this feature provides mains buffering of more than 20 ms over the entire input voltage range.

Wide Range of Applications



The ASI QUINT 100-240/2.4 EFD power supply unit meets the noise immunity and noise emission requirements of EN 55022 Class B. The device can therefore be used universally in harsh industrial environments as well as in commercial and domestic environments, which are susceptible to interference.

Technical Data

Input Data	
Nominal input voltage (wide-range input)	100 V AC - 240 V AC
Input voltage range	85 V AC - 264 V AC/90 V AC - 350 V DC
Frequency	45 Hz - 65 Hz/0 Hz
Current consumption (for nominal values)	1.2 A (120 V AC)/0.5 A (230 V AC), approximately
Inrush current limiting/ I^2t (+25°C [+77°F])	< 15 A/< 2.2 A ² s, typical
Mains buffering for a nominal load (typical)	> 20 ms (120 V AC)/> 80 ms (230 V AC)
Switch-on time after applying the mains voltage	< 0.5 s
Transient surge protection	Varistor
Input fuse, internal (device protection)	5 AT
Recommended backup fuse Circuit breaker Characteristic (EN 60898)	6 A/10 A/16 A B
Discharge current for PE	< 3.5 mA

Output Data	
Nominal output voltage U_N /tolerance	30.1 V DC/±1.5%
Output current during convection cooling: POWER BOOST I_{BOOST} -25°C to +40°C (-13°F to +104°F) Nominal output current I_N -25°C to +60°C (-13°F to +140°F)	3 A ($U_{out} = 30.1$ V DC) 2.4 A ($U_{out} = 30.1$ V DC)
Derating from +60°C (+140°F)	2.5%/K
Short-circuit current limit I_{BOOST} , approximately	≈ 3 A
Startup of unlimited capacitive loads	Yes
Maximum power dissipation No load/nominal load, approximately	3 W/11 W
Efficiency (for 230 V AC and nominal values)	> 86%
Residual ripple/switching peaks (0 - 10 kHz/10 - 500 kHz)	< 100 mV _{SS} / < 50 mV _{SS}
Internal surge protection	Yes, < 35 V DC
Resistance to return supply	35 V DC

Signal Output Data	
EFD (floating: ground fault detected ≙ contact open)	≤ 30 V AC/DC; ≤ 1 A
EFD (ground fault detected ≙ LED flashes)	Red LED
LED DC OK ($U_{out} < 0.9 \times U_N$ ≙ LED flashes)	Green LED

Approvals/Standards		CB 
Electrical equipment of machines (Surge Voltage Category III)		EN 60204
Safety transformers for switched-mode power supply units		EN 61558-2-17
Electrical safety (of IT equipment)		EN 60950/VDE 0805, UL/C-UL Recognized UL 60950 
Industrial control equipment		UL/C-UL Listed UL 508 
Electronic equipment for use in electrical power installations		EN 50178/VDE 0160
Safety extra-low voltage		PELV (EN 60204)/SELV (EN 60950)
Safe isolation		VDE 0100-410
Protection against electric shock		DIN 57100-410
Protection against electric shock, basic requirements for safe isolation in electrical equipment		DIN VDE 0106-101
Limitation of harmonic line currents		According to EN 61000-3-2

General Data		
Insulation voltage input/output	Type test/routine test	4 kV AC/2 kV AC
Input/PE	Type test/routine test	3.5 kV AC/2 kV AC
Output/PE	Routine test	500 V DC
Degree of protection		IP20
Class of protection	(with PE connection)	I
MTBF	according to IEC 61709 (SN 29 500)	> 500,000 h
Housing version		AluNox (AlMg1), closed
Dimensions (W x H x D) + DIN rail		55 mm x 130 mm x 125 mm (2.165 x 5.118 x 4.921 in.) 122 mm x 130 mm x 58 mm (4.803 x 5.118 x 2.283 in.)
Weight		0.75 kg, approximately

Climatic Data		
Ambient temperature		
Operation		-25°C to +70°C (-13°F to +158°F) (> +60°C [+140°F] derating)
Storage		-40°C to +85°C (-40°F to +185°F)
Humidity	at +25°C (+77°F), no condensation	≤ 95%
Vibration	according to IEC 60068-2-6	< 15 Hz, amplitude ±2.5 mm 15 Hz - 150 Hz, 2.3g, t _V = 90 minutes

Climatic Data (Continued)		
Shock (in all space directions) according to IEC 60068-2-27		30g
Degree of pollution	according to EN 50178	2
Climatic category	according to EN 60721	3K3

Conformance With EMC Directive 89/336/EEC and Low Voltage Directive 73/23/EEC				
Noise Immunity Test According to EN 61000-6-2 ¹				
Electrostatic discharge (ESD)	EN 61000-4-2	Criterion B ²	Housing: Contact discharge: Air discharge:	Level 4 8 kV 15 kV
Electromagnetic HF field	EN 61000-4-3	Criterion A ³	Housing: Frequency/field strength:	Level 3 80 MHz - 1000 MHz/ 1.4 GHz - 2.0G Hz/ 10 V/m
Fast transients (burst)	EN 61000-4-4	Criterion B ²	Input: Output: Signal:	4 kV (Level 4) ⁴ 2 kV (Level 3) ⁴ 1 kV (Level 2) ⁴
Surge current loads (surge)	EN 61000-4-5	Criterion B ²	Input: Output: Signal:	4 kV ⁴ /2 kV ⁵ (Level 4) 0.5 kV ⁴ /0.5 kV ⁵ (Level 1) 1 kV ⁴ (Level 2)
Conducted interference	EN 61000-4-6	Criterion A ³	Input/Output/ Signal: Frequency/U ₀ :	(Level 3) ⁴ 0.15 MHz - 80 MHz/10 V
Voltage dips	EN 61000-4-11	Criterion B ²	Input: See mains buffering	> 20 ms
Noise Emission Test According to EN 61000-6-3				
Radio interference emission	EN 55011 EN 55022 ⁶	Class B ⁷		
Radio interference voltage	EN 55011 EN 55022 ⁶	Class B ⁷		

¹ EN 61000 corresponds to IEC 61000

² Criterion B: Temporary adverse effects on the operating characteristics, which the device corrects automatically.

³ Criterion A: Normal operating characteristics within the specified limits.

⁴ Asymmetrical: Cable to ground

⁵ Symmetrical: Cable to cable

⁶ EN 55011 corresponds to CISPR11, EN 55022 corresponds to CISPR22/EN 61000 corresponds to IEC 61000

⁷ Class B: Industrial and domestic applications

Ordering Data

Description	Order Designation	Order No.
Primary-switched power supply	ASI QUINT 100-240/2.4 EFD	27 36 68 6

Device View, Connections, and Control Elements

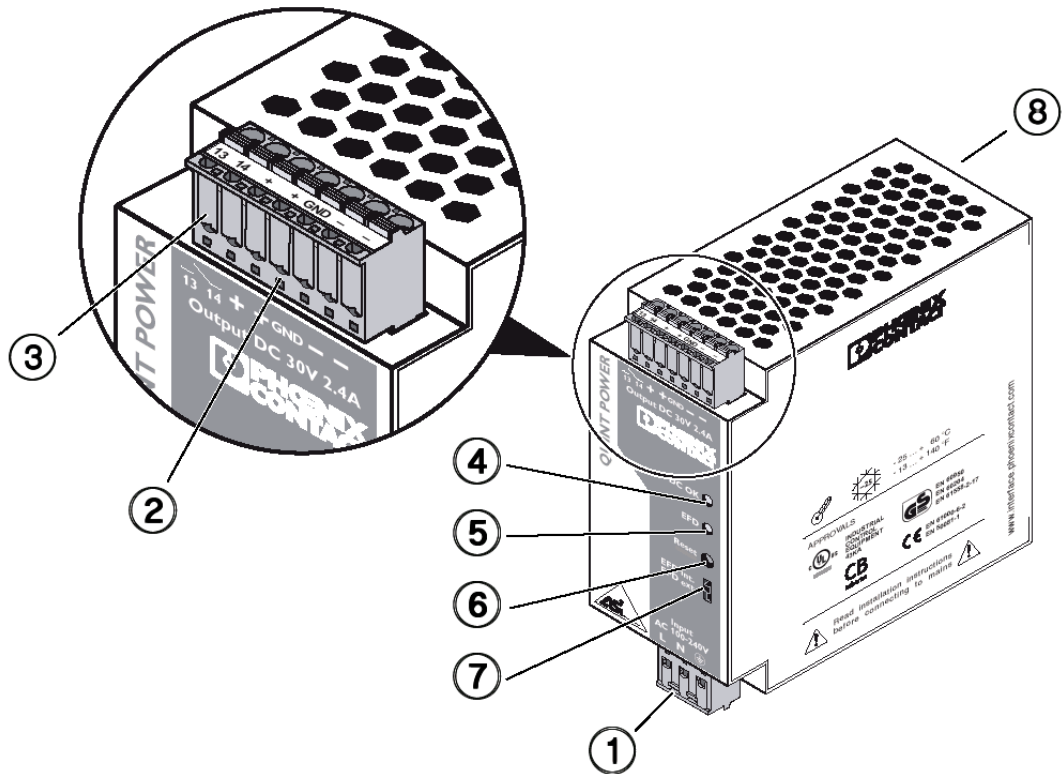

Figure 1 Device connections and control elements

- | | |
|--|---|
| <p>1 AC input: Input voltage 85 - 264 V AC, frequency 45 - 65 Hz</p> <p>2 DC output: Output voltage 30 V DC</p> <p>3 Floating EFD output</p> <p>4 Green DC OK LED</p> <p>5 Red EFD LED</p> <p>6 Reset button</p> <p>7 Internal/external EFD switch</p> | <p>8 Universal DIN rail adapter UTA 107</p> |
|--|---|

Installation

Safety Notes and Warning Instructions



Every AS-Interface system (or segment when using repeaters/extenders) must only ever be supplied by **one** AS-Interface power supply unit.



Installation and startup must only be carried out by qualified personnel. The relevant country-specific regulations (e.g., VDE, DIN) must also be observed.



Before startup it is particularly important to ensure that:

- The mains has been connected correctly and protection is provided against electric shock.
- The device can be switched off outside the power supply according to EN 60950 regulations (e.g., by the line protection on the primary side).
- The protective conductor is connected.
- All supply lines have sufficient fuse protection and are the correct size.
- All output cables are the correct size for the maximum device output current or have separate fuse protection.
- Sufficient convection is ensured.



QUINT POWER is a built-in device. After installation the terminal area must be covered to provide sufficient protection against unauthorized access to live parts. This is ensured by installing the device in the control cabinet or distributor box.

Mounting



Danger

Never carry out work when the power is turned on.



Explosion hazard

Only remove equipment when the power is switched off or the equipment is located in the safe area.



To ensure sufficient convection, we recommend a minimum spacing of 5 cm (1.969 in.) to other modules above and below the device.

No minimum spacing to other modules at the sides is required for proper operation of the device.

The housing temperature can reach high values depending on the ambient temperature and the load of the device.

Mounting on the DIN Rail (Slim Style Installation)

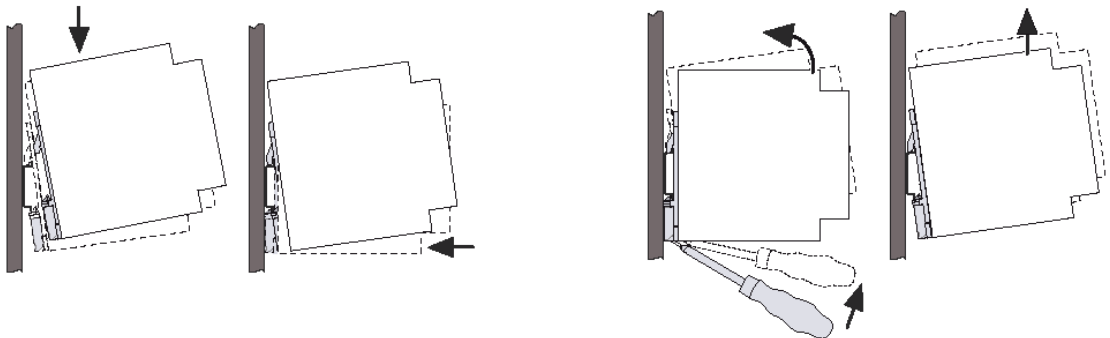

Figure 2 DIN rail mounting/removal

The power supply unit can be snapped onto all 35 mm (1.378 in.) DIN rails according to EN 60715. The device should be mounted horizontally (input terminal blocks facing downwards).

Mounting on the DIN Rail (Flat Mounting Position)

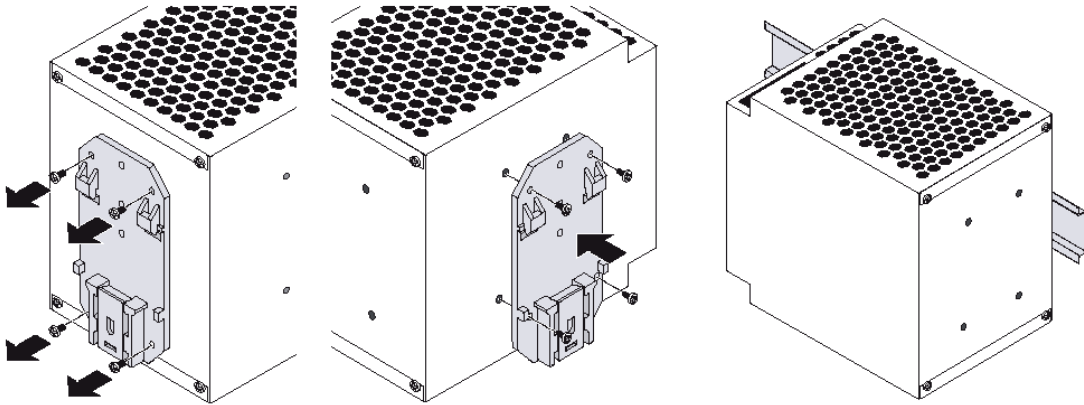

Figure 3 Flat mounting position with universal DIN rail adapter UTA 107

The device is supplied ready for installation in a narrow position. A flat mounting position can be achieved by mounting the module onto the DIN rail at a 90° angle.

To do this, mount the DIN rail adapter UTA 107 as shown in Figure 3 (Torx T10 mounting screws, torque 0.8 - 0.9 Nm (7 - 8 lb in)). No additional mounting material is required.

Connection/Connecting Cable

The device is equipped with plug-in spring-cage terminal blocks. This connection method enables quick device connection and visible isolation of the electrical connection, if required.



Connectors may only be operated when the power is switched off.

The following cable cross sections can be connected:

Solid [mm ²]	Stranded [mm ²]	AWG	Stripping Length L [mm]
0.2 - 2.5	0.2 - 2.5	25 - 14	10 mm (0.39 in.)

To maintain UL approvals, use copper cables, which are designed for operating temperatures > +75°C (+167°F).

For reliable and safe-to-touch connections, strip the cable ends according to Figure 4.

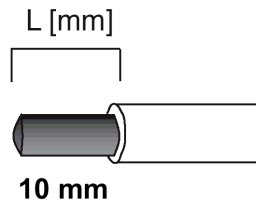

Figure 4 Stripping length

Block Diagram

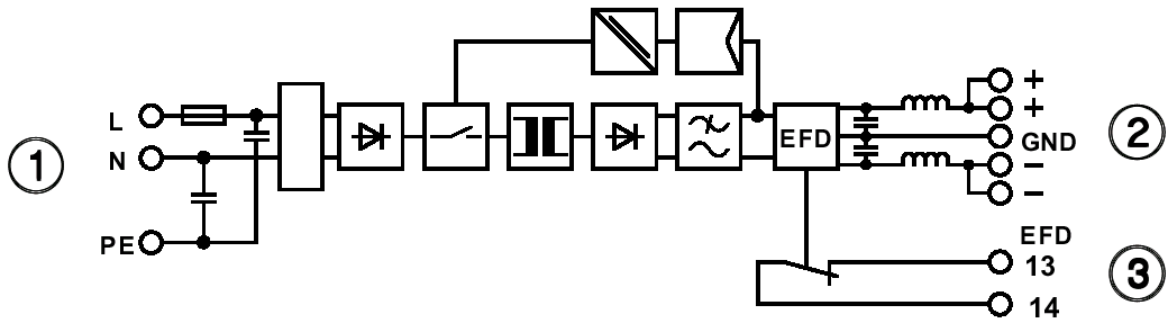

Figure 5 Block diagram

- 1 AC input: Input voltage 85 - 264 V AC, frequency 45 - 65 Hz
- 2 DC output: Output voltage 30 V DC
- 3 Floating EFD output

Input

The 100 - 240 V AC connection is made using connections L, N, and \ominus (see Figure 1, point 1).

The device can be connected to single-phase AC networks or to two external conductors for three-phase networks

(TN, TT or IT network according to VDE 0100-300/IEC 60364-3) with nominal voltages of 100 - 240 V AC (see Figure 6).

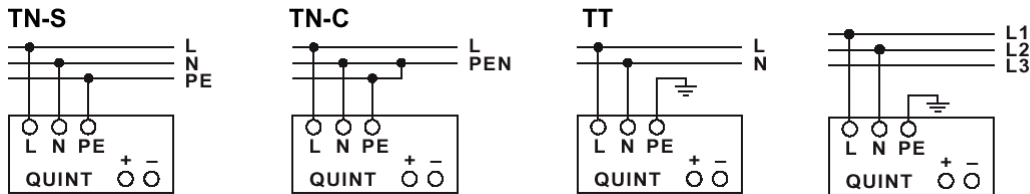

Figure 6 Network types

An **internal fuse** is present for device protection. Additional device protection is not required. The recommended backup fuses are 6 A, 10 A or 16 A circuit breakers, Characteristic B (or equivalent).



A suitable fuse should be provided for DC applications.



An all-pole disconnecting device must be provided for two-phase operation using two external conductors for a three-phase network.



If the internal fuse is blown, this is most probably due to a device fault. In this case, the device should be checked in the factory.

Output

The 30 V DC connection is made using the "+" and "-" connections (see Figure 1, point 2). GND must always be connected to the machine ground. The EFD output (see Figure 1, point 3) is connected via connections "13" and "14".

The device is electronically short-circuit-proof and idling-proof. In the event of an error, the output voltage is limited to a maximum of 35 V DC.

Output Characteristic Curve

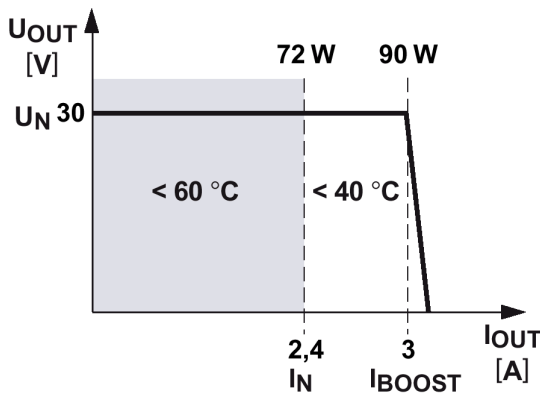

Figure 7 Output characteristic curve

The device operates according to the U/I characteristic curve. With a load, the working point demonstrates this curve. On an overload or short circuit, the output current is limited to I_{BOOST} . The secondary voltage is reduced until the overload or the short circuit on the secondary side is removed.

Temperature Response

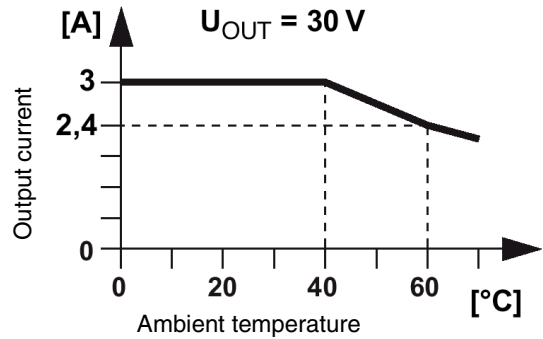

Figure 8 Temperature response

The output power must be decreased by 2.5% per Kelvin temperature increase for ambient temperatures above $+60^\circ\text{C}$ ($+140^\circ\text{F}$).

At ambient temperatures above $+70^\circ\text{C}$ ($+158^\circ\text{F}$) or in the event of a thermal overload, the device does not switch off. The output power is decreased to such an extent that device protection is provided.

Signaling

Preventive DC OK Function Monitoring

The DC OK LED (see Figure 1, point 4) provides function monitoring.

Green "DC OK" LED	Flashing	ON	OFF
Description	Output voltage > 27 V	Output voltage < 27 V	No voltage at the output
Meaning	Output voltage and current OK	QUINT POWER operating, but: <ul style="list-style-type: none"> - Error at the load - Current consumption greater than I_{BOOST} - Output short circuit 	QUINT POWER not operating, because: <ul style="list-style-type: none"> - No mains voltage present - Primary side fuse is blown - Device is faulty

EFD Ground Fault Monitoring

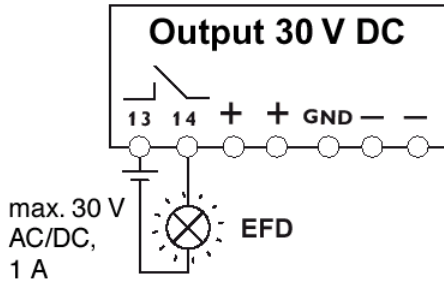

Figure 9 EFD ground fault monitoring

An EFD LED (see Figure 1, point 5) and a floating switching output are used to evaluate a ground fault detected in the AS-i system.

When a ground fault is detected, the LED lights up, the floating EFD output is opened, and in switch position "EFD internal" (see Figure 1, point 7), the device switches off. To restart, press the reset button (see Figure 1, point 6) for > 2 seconds.

In switch position "EFD external", the device continues to detect ground faults.

Briefly activating the reset button (< 1 second) simulates a ground fault.



Make sure you always use the latest documentation.
It can be downloaded from www.download.phoenixcontact.com.

PHOENIX CONTACT GmbH & Co. KG
Flachmarktstr. 8
32825 Blomberg
Germany



+49 - 52 35 - 30 0



+49 - 52 35 - 34 12 00



www.phoenixcontact.com



Worldwide Locations:

www.phoenixcontact.com/salesnetwork

Данный компонент на территории Российской Федерации

Вы можете приобрести в компании MosChip.

Для оперативного оформления запроса Вам необходимо перейти по данной ссылке:

<http://moschip.ru/get-element>

Вы можете разместить у нас заказ для любого Вашего проекта, будь то серийное производство или разработка единичного прибора.

В нашем ассортименте представлены ведущие мировые производители активных и пассивных электронных компонентов.

Нашей специализацией является поставка электронной компонентной базы двойного назначения, продукции таких производителей как XILINX, Intel (ex.ALTERA), Vicor, Microchip, Texas Instruments, Analog Devices, Mini-Circuits, Amphenol, Glenair.

Сотрудничество с глобальными дистрибьюторами электронных компонентов, предоставляет возможность заказывать и получать с международных складов практически любой перечень компонентов в оптимальные для Вас сроки.

На всех этапах разработки и производства наши партнеры могут получить квалифицированную поддержку опытных инженеров.

Система менеджмента качества компании отвечает требованиям в соответствии с ГОСТ Р ИСО 9001, ГОСТ РВ 0015-002 и ЭС РД 009

Офис по работе с юридическими лицами:

105318, г.Москва, ул.Щербаковская д.3, офис 1107, 1118, ДЦ «Щербаковский»

Телефон: +7 495 668-12-70 (многоканальный)

Факс: +7 495 668-12-70 (доб.304)

E-mail: info@moschip.ru

Skype отдела продаж:

moschip.ru

moschip.ru_4

moschip.ru_6

moschip.ru_9