



HIGH-SPEED 8K x 16 DUAL-PORT STATIC RAM

IDT7025S/L

LEAD FINISH (SnPb) ARE IN EOL PROCESS - LAST TIME BUY EXPIRES JUNE 15, 2018

Features

- ◆ True Dual-Ported memory cells which allow simultaneous reads of the same memory location
 - ◆ High-speed access
 - Military: 20/25/35/55/70ns (max.)
 - Industrial: 55ns (max.)
 - Commercial: 15/17/20/25/35/55ns (max.)
 - ◆ Low-power operation
 - IDT7025S
Active: 750mW (typ.)
Standby: 5mW (typ.)
 - IDT7025L
Active: 750mW (typ.)
Standby: 1mW (typ.)
 - ◆ Separate upper-byte and lower-byte control for multiplexed bus compatibility
- ◆ IDT7025 easily expands data bus width to 32 bits or more using the Master/Slave select when cascading more than one device
 - ◆ $\overline{M/\overline{S}} = H$ for \overline{BUSY} output flag on Master
 $\overline{M/\overline{S}} = L$ for \overline{BUSY} input on Slave
 - ◆ Interrupt Flag
 - ◆ On-chip port arbitration logic
 - ◆ Full on-chip hardware support of semaphore signaling between ports
 - ◆ Fully asynchronous operation from either port
 - ◆ Battery backup operation—2V data retention
 - ◆ TTL-compatible, single 5V ($\pm 10\%$) power supply
 - ◆ Available in 84-pin PGA, Flatpack, PLCC, and 100-pin Thin Quad Flatpack
 - ◆ Industrial temperature range (-40°C to $+85^{\circ}\text{C}$) is available for selected speeds
 - ◆ Green parts available, see ordering information

Functional Block Diagram



NOTES:

1. (MASTER): \overline{BUSY} is output; (SLAVE): \overline{BUSY} is input.
2. \overline{BUSY} outputs and \overline{INT} outputs are non-tri-stated push-pull.

MARCH 2018

Description

The IDT7025 is a high-speed 8K x 16 Dual-Port Static RAM. The IDT7025 is designed to be used as a stand-alone 128K-bit Dual-Port RAM or as a combination MASTER/SLAVE Dual-Port RAM for 32-bit or more word systems. Using the IDT MASTER/SLAVE Dual-Port RAM approach in 32-bit or wider memory system applications results in full-speed, error-free operation without the need for additional discrete logic.

This device provides two independent ports with separate control, address, and I/O pins that permit independent, asynchronous access for reads or writes to any location in memory. An automatic power down

feature controlled by Chip Enable (\overline{CE}) permits the on-chip circuitry of each port to enter a very low standby power mode.

Fabricated using IDT's CMOS high-performance technology, these devices typically operate on only 750mW of power. Low-power (L) versions offer battery backup data retention capability with typical power consumption of 500 μ W from a 2V battery.

The IDT7025 is packaged in a ceramic 84-pin PGA, an 84-pin Flatpack, PLCC, and a 100-pin TQFP. Military grade product is manufactured in compliance with the latest revision of MIL-PRF-38535 QML, making it ideally suited to military temperature applications demanding the highest level of performance and reliability.

Pin Configurations^(1,2,3)



2683 drw 02

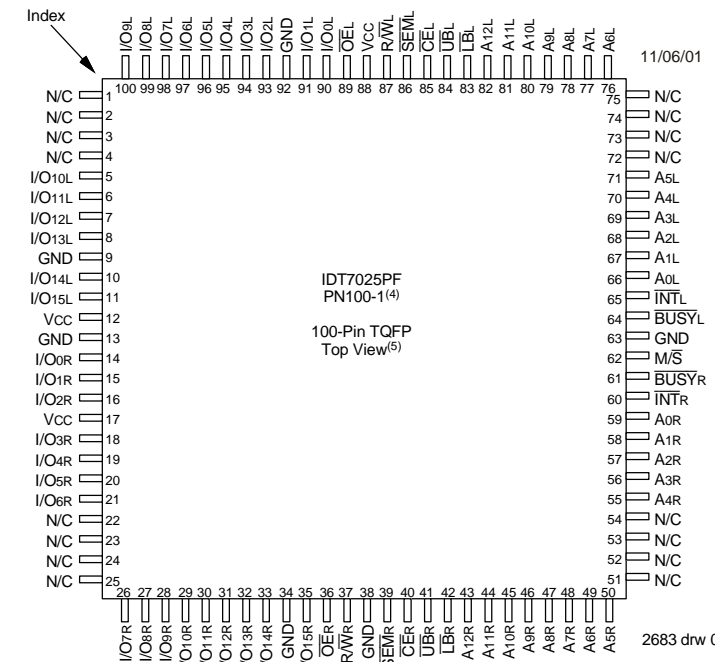

2683 drw 03

NOTES:

1. All Vcc pins must be connected to power supply.
2. All GND pins must be connected to ground supply.
3. J84-1 package body is approximately 1.15 in x 1.15 in x .17 in.
F84-2 package body is approximately 1.17 in x 1.17 in x .11 in.
PN100-1 package body is approximately 14mm x 14mm x 1.4mm.
4. This package code is used to reference the package diagram.
5. This text does not indicate orientation of the actual part-marking.

Pin Configurations^(1,2,3) (con't.)

11/06/01



2683 drw 04

NOTES:

1. All Vcc pins must be connected to power supply.
2. All GND pins must be connected to ground supply.
3. Package body is approximately 1.12 in x 1.12 in x .16 in.
4. This package code is used to reference the package diagram.
5. This text does not indicate orientation of the actual part-marking.

Pin Names

Left Port	Right Port	Names
\overline{CE}_L	\overline{CE}_R	Chip Enable
R/\overline{WL}	R/\overline{WR}	Read/Write Enable
\overline{OE}_L	\overline{OE}_R	Output Enable
$A_{0L} - A_{12L}$	$A_{0R} - A_{12R}$	Address
$I/O_{0L} - I/O_{15L}$	$I/O_{0R} - I/O_{15R}$	Data Input/Output
\overline{SEM}_L	\overline{SEM}_R	Semaphore Enable
\overline{UB}_L	\overline{UB}_R	Upper Byte Select
\overline{LB}_L	\overline{LB}_R	Lower Byte Select
\overline{INT}_L	\overline{INT}_R	Interrupt Flag
\overline{BUSY}_L	\overline{BUSY}_R	Busy Flag
	M/\overline{S}	Master or Slave Select
	V_{CC}	Power
	GND	Ground

2683 tbl 01

Truth Table I: Non-Contention Read/Write Control

Inputs ⁽¹⁾						Outputs		Mode
\overline{CE}	R/W	\overline{OE}	\overline{UB}	\overline{LB}	\overline{SEM}	I/O ₈₋₁₅	I/O ₀₋₇	
H	X	X	X	X	H	High-Z	High-Z	Deselected
X	X	X	H	H	H	High-Z	High-Z	Both Bytes Deselected
L	L	X	L	H	H	DATA _{IN}	High-Z	Write to Upper Byte Only
L	L	X	H	L	H	High-Z	DATA _{IN}	Write to Lower Byte Only
L	L	X	L	L	H	DATA _{IN}	DATA _{IN}	Write to Both Bytes
L	H	L	L	H	H	DATA _{OUT}	High-Z	Read Upper Byte Only
L	H	L	H	L	H	High-Z	DATA _{OUT}	Read Lower Byte Only
L	H	L	L	L	H	DATA _{OUT}	DATA _{OUT}	Read Both Bytes
X	X	H	X	X	X	High-Z	High-Z	Outputs Disabled

NOTE:

1. A_{0L} — A_{12L} ≠ A_{0R} — A_{12R}.

2683 tbl 02

Truth Table II: Semaphore Read/Write Control⁽¹⁾

Inputs						Outputs		Mode
\overline{CE}	R/W	\overline{OE}	\overline{UB}	\overline{LB}	\overline{SEM}	I/O ₈₋₁₅	I/O ₀₋₇	
H	H	L	X	X	L	DATA _{OUT}	DATA _{OUT}	Read Semaphore Flag Data Out
X	H	L	H	H	L	DATA _{OUT}	DATA _{OUT}	Read Semaphore Flag Data Out
H	↑	X	X	X	L	DATA _{IN}	DATA _{IN}	Write I/O ₀ into Semaphore Flag
X	↑	X	H	H	L	DATA _{IN}	DATA _{IN}	Write I/O ₀ into Semaphore Flag
L	X	X	L	X	L	—	—	Not Allowed
L	X	X	X	L	L	—	—	Not Allowed

NOTES:

1. There are eight semaphore flags written to via I/O₀ and read from I/O₀ - I/O₁₅. These eight semaphores are addressed by A₀ - A₂.

2683 tbl 03

Absolute Maximum Ratings⁽¹⁾

Symbol	Rating	Commercial & Industrial	Military	Unit
V _{TERM} ⁽²⁾	Terminal Voltage with Respect to GND	-0.5 to +7.0	-0.5 to +7.0	V
T _{BIAS}	Temperature Under Bias	-55 to +125	-65 to +135	°C
T _{STG}	Storage Temperature	-65 to +150	-65 to +150	°C
I _{OUT}	DC Output Current	50	50	mA

2683 tbl 04

NOTES:

- Stresses greater than those listed under ABSOLUTE MAXIMUM RATINGS may cause permanent damage to the device. This is a stress rating only and functional operation of the device at these or any other conditions above those indicated in the operational sections of this specification is not implied. Exposure to absolute maximum rating conditions for extended periods may affect reliability.
- V_{TERM} must not exceed V_{CC} + 10% for more than 25% of the cycle time or 10ns maximum, and is limited to ≤ 20 mA for the period over V_{TERM} ≥ V_{CC} + 10%.

Capacitance⁽¹⁾ (T_A = +25°C, f = 1.0mhz)

Symbol	Parameter	Conditions ⁽²⁾	Max.	Unit
C _{IN}	Input Capacitance	V _{IN} = 3dV	9	pF
C _{OUT}	Output Capacitance	V _{OUT} = 3dV	10	pF

2683 tbl 07

NOTES:

- This parameter is determined by device characterization but is not production tested. For TQFP package only.
- 3dV references the interpolated capacitance when the input and output signals switch from 0V to 3V or from 3V to 0V.

Maximum Operating Temperature and Supply Voltage⁽¹⁾

Grade	Ambient Temperature	GND	V _{CC}
Military	-55°C to +125°C	0V	5.0V ± 10%
Commercial	0°C to +70°C	0V	5.0V ± 10%
Industrial	-40°C to +85°C	0V	5.0V ± 10%

2683 tbl 05

NOTES:

- This is parameter T_A. This is the "instant on" case temperature.

Recommended DC Operating Conditions

Symbol	Parameter	Min.	Typ.	Max.	Unit
V _{CC}	Supply Voltage	4.5	5.0	5.5	V
GND	Ground	0	0	0	V
V _{IH}	Input High Voltage	2.2	—	6.0 ⁽²⁾	V
V _{IL}	Input Low Voltage	-0.5 ⁽¹⁾	—	0.8	V

2683 tbl 06

NOTES:

- V_{IL} ≥ -1.5V for pulse width less than 10ns.
- V_{TERM} must not exceed V_{CC} + 10%.

DC Electrical Characteristics Over the Operating Temperature and Supply Voltage Range (V_{CC} = 5.0V ± 10%)

Symbol	Parameter	Test Conditions	7025S		7025L		Unit
			Min.	Max.	Min.	Max.	
I _L	Input Leakage Current ⁽¹⁾	V _{CC} = 5.5V, V _{IN} = 0V to V _{CC}	—	10	—	5	μA
I _{LO}	Output Leakage Current	V _{OUT} = 0V to V _{CC}	—	10	—	5	μA
V _{OL}	Output Low Voltage	I _{OL} = +4mA	—	0.4	—	0.4	V
V _{OH}	Output High Voltage	I _{OH} = -4mA	2.4	—	2.4	—	V

2683 tbl 08

NOTE:

- At V_{CC} ≤ 2.0V input leakages are undefined.

DC Electrical Characteristics Over the Operating Temperature and Supply Voltage Range⁽¹⁾ (V_{CC} = 5.0V ± 10%)

Symbol	Parameter	Test Condition	Version	7025X15 Com'l Only		7025X17 Com'l Only		7025X20 Com'l, Ind & Military		7025X25 Com'l & Military		Unit	
				Typ. ⁽²⁾	Max.	Typ. ⁽²⁾	Max.	Typ. ⁽²⁾	Max.	Typ. ⁽²⁾	Max.		
I _{CC}	Dynamic Operating Current (Both Ports Active)	$\overline{CE} = V_{IL}$, Outputs Disabled $\overline{SEM} = V_{IH}$ $f = f_{MAX}^{(3)}$	COM'L	S	170	310	170	310	160	290	155	265	mA
				L	170	260	170	260	160	240	155	220	
			MIL & IND	S	—	—	—	—	160	370	155	340	
				L	—	—	—	—	160	320	155	280	
I _{SB1}	Standby Current (Both Ports - TTL Level Inputs)	$\overline{CE}_L = \overline{CE}_R = V_{IH}$ $\overline{SEM}_R = \overline{SEM}_L = V_{IH}$ $f = f_{MAX}^{(3)}$	COM'L	S	20	60	20	60	20	60	16	60	mA
				L	20	50	20	50	20	50	16	50	
			MIL & IND	S	—	—	—	—	20	90	16	80	
				L	—	—	—	—	20	70	16	65	
I _{SB2}	Standby Current (One Port - TTL Level Inputs)	$\overline{CE}_{A^*} = V_{IL}$ and $\overline{CE}_{B^*} = V_{IH}^{(5)}$ Active Port Outputs Disabled, $f = f_{MAX}^{(3)}$ $\overline{SEM}_R = \overline{SEM}_L = V_{IH}$	COM'L	S	105	190	105	190	95	180	90	170	mA
				L	105	160	105	160	95	150	90	140	
			MIL & IND	S	—	—	—	—	95	240	90	215	
				L	—	—	—	—	95	210	90	180	
I _{SB3}	Full Standby Current (Both Ports - CMOS Level Inputs)	\overline{CE}_L and $\overline{CE}_R \geq V_{CC} - 0.2V$, $V_{IN} \geq V_{CC} - 0.2V$ or $V_{IN} \leq 0.2V, f = 0^{(4)}$ $\overline{SEM}_R = \overline{SEM}_L \geq V_{CC} - 0.2V$	COM'L	S	1.0	15	1.0	15	1.0	15	1.0	15	mA
				L	0.2	5	0.2	5	0.2	5	0.2	5	
			MIL & IND	S	—	—	—	—	1.0	30	1.0	30	
				L	—	—	—	—	0.2	10	0.2	10	
I _{SB4}	Full Standby Current (One Port - CMOS Level Inputs)	$\overline{CE}_{A^*} \leq 0.2V$ and $\overline{CE}_{B^*} \geq V_{CC} - 0.2V^{(5)}$ $\overline{SEM}_R = \overline{SEM}_L \geq V_{CC} - 0.2V$ $V_{IN} \geq V_{CC} - 0.2V$ or $V_{IN} \leq 0.2V$ Active Port Outputs Disabled, $f = f_{MAX}^{(3)}$	COM'L	S	100	170	100	170	90	155	85	145	mA
				L	100	140	100	140	90	130	85	120	
			MIL & IND	S	—	—	—	—	90	225	85	200	
				L	—	—	—	—	90	200	85	170	

2683 tbl 09a

Symbol	Parameter	Test Condition	Version	7025X35 Com'l & Military		7025X55 Com'l, Ind & Military		7025X70 Military Only		Unit	
				Typ. ⁽²⁾	Max.	Typ. ⁽²⁾	Max.	Typ. ⁽²⁾	Max.		
I _{CC}	Dynamic Operating Current (Both Ports Active)	$\overline{CE} = V_{IL}$, Outputs Disabled $\overline{SEM} = V_{IH}$ $f = f_{MAX}^{(3)}$	COM'L	S	150	250	150	250	—	—	mA
				L	150	210	150	210	—	—	
			MIL & IND	S	150	300	150	300	140	300	
				L	150	250	150	250	140	250	
I _{SB1}	Standby Current (Both Ports - TTL Level Inputs)	$\overline{CE}_L = \overline{CE}_R = V_{IH}$ $\overline{SEM}_R = \overline{SEM}_L = V_{IH}$ $f = f_{MAX}^{(3)}$	COM'L	S	13	60	13	60	—	—	mA
				L	13	50	13	50	—	—	
			MIL & IND	S	13	80	13	80	10	80	
				L	13	65	13	65	10	65	
I _{SB2}	Standby Current (One Port - TTL Level Inputs)	$\overline{CE}_{A^*} = V_{IL}$ and $\overline{CE}_{B^*} = V_{IH}^{(5)}$ Active Port Outputs Disabled, $f = f_{MAX}^{(3)}$ $\overline{SEM}_R = \overline{SEM}_L = V_{IH}$	COM'L	S	85	155	85	155	—	—	mA
				L	85	130	85	130	—	—	
			MIL & IND	S	85	190	85	190	80	190	
				L	85	160	85	160	80	160	
I _{SB3}	Full Standby Current (Both Ports - CMOS Level Inputs)	\overline{CE}_L and $\overline{CE}_R \geq V_{CC} - 0.2V$, $V_{IN} \geq V_{CC} - 0.2V$ or $V_{IN} \leq 0.2V, f = 0^{(4)}$ $\overline{SEM}_R = \overline{SEM}_L \geq V_{CC} - 0.2V$	COM'L	S	1.0	15	1.0	15	—	—	mA
				L	0.2	5	0.2	5	—	—	
			MIL & IND	S	1.0	30	1.0	30	1.0	30	
				L	0.2	10	0.2	10	0.2	10	
I _{SB4}	Full Standby Current (One Port - CMOS Level Inputs)	$\overline{CE}_{A^*} \leq 0.2V$ and $\overline{CE}_{B^*} \geq V_{CC} - 0.2V^{(5)}$ $\overline{SEM}_R = \overline{SEM}_L \geq V_{CC} - 0.2V$ $V_{IN} \geq V_{CC} - 0.2V$ or $V_{IN} \leq 0.2V$ Active Port Outputs Disabled, $f = f_{MAX}^{(3)}$	COM'L	S	80	135	80	135	—	—	mA
				L	80	110	80	110	—	—	
			MIL & IND	S	80	175	80	175	75	175	
				L	80	150	80	150	75	150	

2683 tbl 09b

NOTES:

- 'X' in part number indicates power rating (S or L)
- V_{CC} = 5V, T_A = +25°C, and are not production tested. I_{CC} dc = 120mA (TYP)
- At f = f_{MAX}, address and I/O's are cycling at the maximum frequency read cycle of 1/trc, and using "AC Test Conditions" of input levels of GND to 3V.
- f = 0 means no address or control lines change.
- Port "A" may be either left or right port. Port "B" is the opposite from port "A".

Data Retention Characteristics Over All Temperature Ranges (L Version Only)

Symbol	Parameter	Test Condition	Min.	Typ. ⁽¹⁾	Max.	Unit
V _{DR}	V _{CC} for Data Retention	V _{CC} = 2V	2.0	—	—	V
I _{CCDR}	Data Retention Current	$\overline{CE} \geq V_{HC}$ $V_{IN} \geq V_{HC}$ or $\leq V_{LC}$	MIL. & IND. —	100	4000	μA
			COM'L. —	100	1500	
t _{CDR} ⁽³⁾	Chip Deselect to Data Retention Time	$\overline{SEM} \geq V_{HC}$	0	—	—	ns
t _R ⁽³⁾	Operation Recovery Time		t _{RC} ⁽²⁾	—	—	ns

2683 tbl 10

NOTES:

1. T_A = +25°C, V_{CC} = 2V, and are not production tested.
2. t_{RC} = Read Cycle Time
3. This parameter is guaranteed by device characterization, but is not production tested.
4. At V_{CC} ≤ 2.0V input leakages are undefined.

Data Retention Waveform



2683 drw 05

AC Test Conditions

Input Pulse Levels	GND to 3.0V
Input Rise/Fall Times	5ns Max.
Input Timing Reference Levels	1.5V
Output Reference Levels	1.5V
Output Load	Figures 1 and 2

2683 tbl 11



Figure 1. AC Output Test Load



2683 drw 06

Figure 2. Output Test Load
(for t_{LZ}, t_{HZ}, t_{WZ}, t_{OW})
* including scope and jig.

AC Electrical Characteristics Over the Operating Temperature and Supply Voltage Range⁽⁴⁾

Symbol	Parameter	7025X15 Com'l Only		7025X17 Com'l Only		7025X20 Com'l, Ind & Military		7025X25 Com'l & Military		Unit
		Min.	Max.	Min.	Max.	Min.	Max.	Min.	Max.	
READ CYCLE										
t _{RC}	Read Cycle Time	15	—	17	—	20	—	25	—	ns
t _{AA}	Address Access Time	—	15	—	17	—	20	—	25	ns
t _{ACE}	Chip Enable Access Time ⁽⁶⁾	—	15	—	17	—	20	—	25	ns
t _{ABE}	Byte Enable Access Time ⁽⁶⁾	—	15	—	17	—	20	—	25	ns
t _{AOE}	Output Enable Access Time ⁽⁶⁾	—	10	—	10	—	12	—	13	ns
t _{OH}	Output Hold from Address Change	3	—	3	—	3	—	3	—	ns
t _{LZ}	Output Low-Z Time ^(1,2)	3	—	3	—	3	—	3	—	ns
t _{HZ}	Output High-Z Time ^(1,2)	—	10	—	10	—	12	—	15	ns
t _{PU}	Chip Enable to Power Up Time ^(1,2)	0	—	0	—	0	—	0	—	ns
t _{PD}	Chip Disable to Power Down Time ^(1,2)	—	15	—	17	—	20	—	25	ns
t _{SOP}	Semaphore Flag Update Pulse (\overline{OE} or \overline{SEM})	10	—	10	—	10	—	10	—	ns
t _{SAA}	Semaphore Address Access ⁽³⁾	—	15	—	17	—	20	—	25	ns

2683 tbl 12a

Symbol	Parameter	7025X35 Com'l & Military		7025X55 Com'l, Ind & Military		7025X70 Military Only		Unit
		Min.	Max.	Min.	Max.	Min.	Max.	
READ CYCLE								
t _{RC}	Read Cycle Time	35	—	55	—	70	—	ns
t _{AA}	Address Access Time	—	35	—	55	—	70	ns
t _{ACE}	Chip Enable Access Time ⁽⁶⁾	—	35	—	55	—	70	ns
t _{ABE}	Byte Enable Access Time ⁽⁶⁾	—	35	—	55	—	70	ns
t _{AOE}	Output Enable Access Time ⁽⁶⁾	—	20	—	30	—	35	ns
t _{OH}	Output Hold from Address Change	3	—	3	—	3	—	ns
t _{LZ}	Output Low-Z Time ^(1,2)	3	—	3	—	3	—	ns
t _{HZ}	Output High-Z Time ^(1,2)	—	15	—	25	—	30	ns
t _{PU}	Chip Enable to Power Up Time ^(1,2)	0	—	0	—	0	—	ns
t _{PD}	Chip Disable to Power Down Time ^(1,2)	—	35	—	50	—	50	ns
t _{SOP}	Semaphore Flag Update Pulse (\overline{OE} or \overline{SEM})	15	—	15	—	15	—	ns
t _{SAA}	Semaphore Address Access ⁽³⁾	—	35	—	55	—	70	ns

2683 tbl 12b

NOTES:

1. Transition is measured 0mV from Low or High-impedance voltage with Output Test Load (Figure 2).
2. This parameter is guaranteed by device characterization, but is not production tested.
3. To access RAM, $\overline{CE} = V_{IL}$, \overline{UB} or $\overline{LB} = V_{IL}$, and $\overline{SEM} = V_{IH}$. To access semaphore, $\overline{CE} = V_{IH}$ or \overline{UB} & $\overline{LB} = V_{IH}$, and $\overline{SEM} = V_{IL}$.
4. 'X' in part number indicates power rating (S or L).

Waveform of Read Cycles⁽⁵⁾

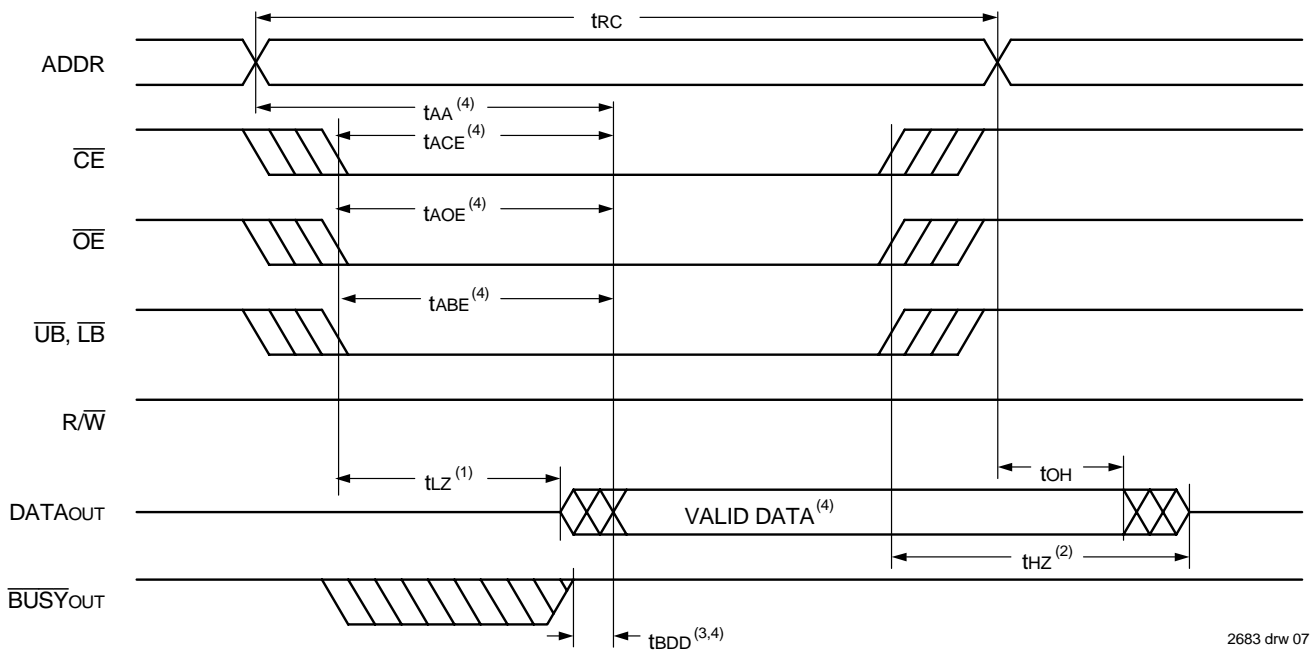

2683 drw 07

NOTES:

1. Timing depends on which signal is asserted last, \overline{OE} , \overline{CE} , \overline{LB} , or \overline{UB} .
2. Timing depends on which signal is de-asserted first, \overline{CE} , \overline{OE} , \overline{LB} , or \overline{UB} .
3. t_{BDD} delay is required only in case where opposite port is completing a write operation to the same address location for simultaneous read operations \overline{BUSY} has no relation to valid output data.
4. Start of valid data depends on which timing becomes effective last t_{ABE} , t_{AOE} , t_{ACE} , t_{AA} or t_{BDD} .
5. $\overline{SEM} = V_{IH}$.

Timing of Power-Up Power-Down

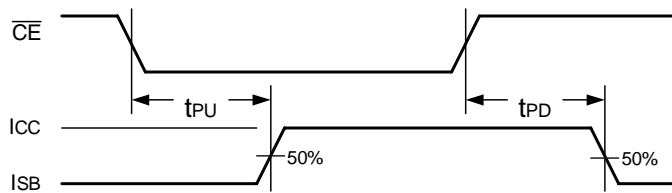

2683 drw 08

AC Electrical Characteristics Over the Operating Temperature and Supply Voltage⁽⁵⁾

Symbol	Parameter	7025X15 Com'l Only		7025X17 Com'l Only		7025X20 Com'l, Ind & Military		7025X25 Com'l & Military		Unit
		Min.	Max.	Min.	Max.	Min.	Max.	Min.	Max.	
WRITE CYCLE										
t _{WC}	Write Cycle Time	15	—	17	—	20	—	25	—	ns
t _{EW}	Chip Enable to End-of-Write ⁽³⁾	12	—	12	—	15	—	20	—	ns
t _{AW}	Address Valid to End-of-Write	12	—	12	—	15	—	20	—	ns
t _{AS}	Address Set-up Time ⁽³⁾	0	—	0	—	0	—	0	—	ns
t _{WP}	Write Pulse Width	12	—	12	—	15	—	20	—	ns
t _{WR}	Write Recovery Time	0	—	0	—	0	—	0	—	ns
t _{DW}	Data Valid to End-of-Write	10	—	10	—	15	—	15	—	ns
t _{HZ}	Output High-Z Time ^(1,2)	—	10	—	10	—	12	—	15	ns
t _{DH}	Data Hold Time ⁽⁴⁾	0	—	0	—	0	—	0	—	ns
t _{WZ}	Write Enable to Output in High-Z ^(1,2)	—	10	—	10	—	12	—	15	ns
t _{OW}	Output Active from End-of-Write ^(1,2,4)	0	—	0	—	0	—	0	—	ns
t _{SWRD}	$\overline{\text{SEM}}$ Flag Write to Read Time	5	—	5	—	5	—	5	—	ns
t _{SPS}	$\overline{\text{SEM}}$ Flag Contention Window	5	—	5	—	5	—	5	—	ns

2683 tbl 13a

Symbol	Parameter	7025X35 Com'l & Military		7025X55 Com'l, Ind & Military		7025X70 Military Only		Unit
		Min.	Max.	Min.	Max.	Min.	Max.	
WRITE CYCLE								
t _{WC}	Write Cycle Time	35	—	55	—	70	—	ns
t _{EW}	Chip Enable to End-of-Write ⁽³⁾	30	—	45	—	50	—	ns
t _{AW}	Address Valid to End-of-Write	30	—	45	—	50	—	ns
t _{AS}	Address Set-up Time ⁽³⁾	0	—	0	—	0	—	ns
t _{WP}	Write Pulse Width	25	—	40	—	50	—	ns
t _{WR}	Write Recovery Time	0	—	0	—	0	—	ns
t _{DW}	Data Valid to End-of-Write	15	—	30	—	40	—	ns
t _{HZ}	Output High-Z Time ^(1,2)	—	15	—	25	—	30	ns
t _{DH}	Data Hold Time ⁽⁴⁾	0	—	0	—	0	—	ns
t _{WZ}	Write Enable to Output in High-Z ^(1,2)	—	15	—	25	—	30	ns
t _{OW}	Output Active from End-of-Write ^(1,2,4)	0	—	0	—	0	—	ns
t _{SWRD}	$\overline{\text{SEM}}$ Flag Write to Read Time	5	—	5	—	5	—	ns
t _{SPS}	$\overline{\text{SEM}}$ Flag Contention Window	5	—	5	—	5	—	ns

2683 tbl 13b

NOTES:

1. Transition is measured 0mV from Low or High-impedance voltage with the Output Test Load (Figure 2).
2. This parameter is guaranteed by device characterization, but is not production tested.
3. To access RAM, $\overline{\text{CE}} = \text{V}_{\text{IL}}$, $\overline{\text{UB}}$ or $\overline{\text{LB}} = \text{V}_{\text{IL}}$, $\overline{\text{SEM}} = \text{V}_{\text{IH}}$. To access semaphore, $\overline{\text{CE}} = \text{V}_{\text{IH}}$ or $\overline{\text{UB}} \& \overline{\text{LB}} = \text{V}_{\text{IH}}$, and $\overline{\text{SEM}} = \text{V}_{\text{IL}}$. Either condition must be valid for the entire t_{EW} time.
4. The specification for t_{DH} must be met by the device supplying write data to the RAM under all operating conditions. Although t_{DH} and t_{OW} values will vary over voltage and temperature, the actual t_{DH} will always be smaller than the actual t_{OW}.
5. 'X' in part number indicates power rating (S or L).

Timing Waveform of Write Cycle No. 1, R/\overline{W} Controlled Timing^(1,5,8)



2683 drw 09

Timing Waveform of Write Cycle No. 2, \overline{CE} , \overline{UB} , \overline{LB} Controlled Timing^(1,5)

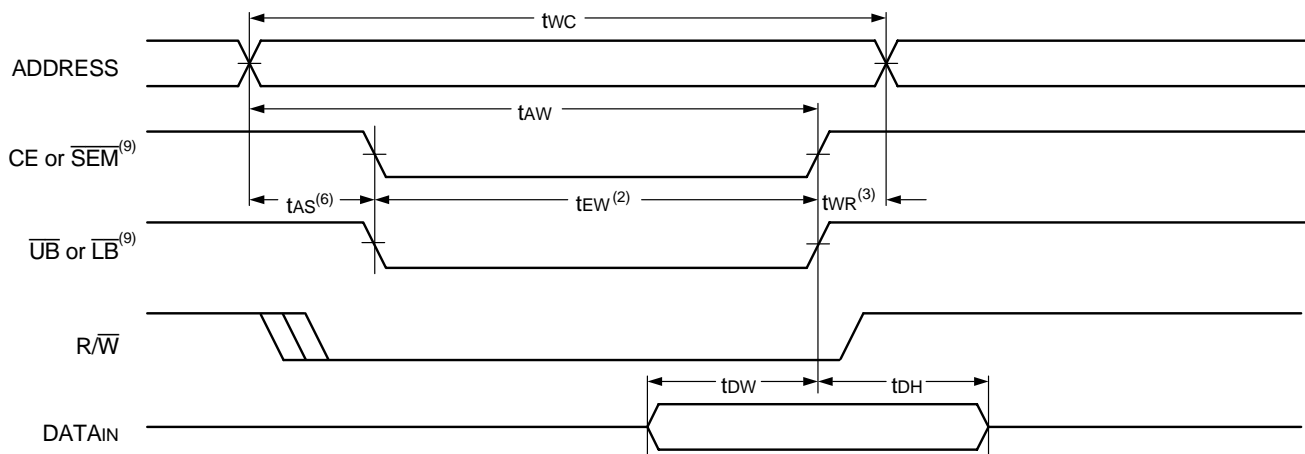

2683 drw 10

NOTES:

1. R/\overline{W} or \overline{CE} or \overline{UB} & \overline{LB} = V_{IH} during all address transitions.
2. A write occurs during the overlap (t_{EW} or t_{WP}) of a \overline{UB} or \overline{LB} = V_{iL} and a \overline{CE} = V_{iL} and a R/\overline{W} = V_{iL} for memory array writing cycle.
3. t_{WR} is measured from the earlier of \overline{CE} or R/\overline{W} (or \overline{SEM} or R/\overline{W}) going to V_{iH} to the end-of-write cycle.
4. During this period, the I/O pins are in the output state and input signals must not be applied.
5. If the \overline{CE} or \overline{SEM} LOW = V_{iL} transition occurs simultaneously with or after the R/\overline{W} = V_{iL} transition, the outputs remain in the HIGH impedance state.
6. Timing depends on which enable signal is asserted last, \overline{CE} , R/\overline{W} , or byte control.
7. This parameter is guaranteed by device characterization, but is not production tested. Transition is measured 0mV from steady state with Output Test Load (Figure 2).
8. If \overline{OE} = V_{iL} during R/\overline{W} controlled write cycle, the write pulse width must be the larger of t_{WP} or (t_{WZ} + t_{DW}) to allow the I/O drivers to turn off and data to be placed on the bus for the required t_{DW} . If \overline{OE} = V_{iH} during an R/\overline{W} controlled write cycle, this requirement does not apply and the write pulse can be as short as the specified t_{WP} .
9. To access RAM, \overline{CE} = V_{iL} , \overline{UB} or \overline{LB} = V_{iL} , and \overline{SEM} = V_{iH} . To access Semaphore, \overline{CE} = V_{iH} or \overline{UB} & \overline{LB} = V_{iH} , and \overline{SEM} = V_{iL} . t_{EW} must be met for either condition.

Timing Waveform of Semaphore Read after Write Timing, Either Side⁽¹⁾

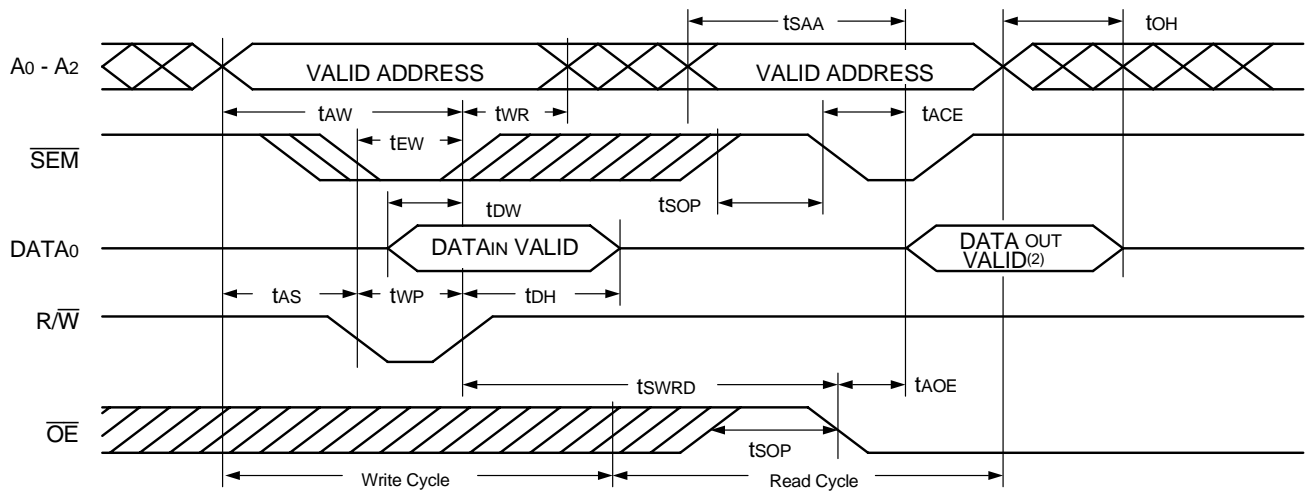

2683 drw 11

NOTE:

1. $\overline{CE} = V_{IH}$ or $\overline{UB} \& \overline{LB} = V_{IH}$ for the duration of the above timing (both write and read cycle).
2. "DATAout VALID" represents all I/O's (I/O₀-I/O₁₅) equal to the semaphore value.

Timing Waveform of Semaphore Write Contention^(1,3,4)

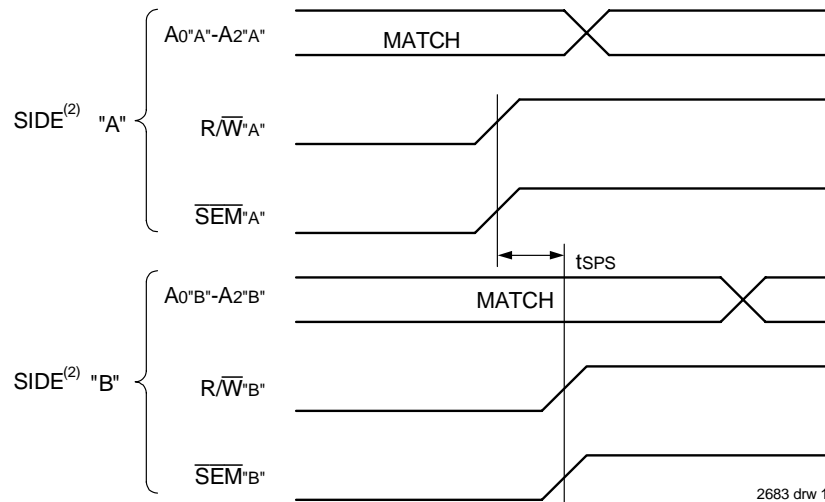

2683 drw 12

NOTES:

1. $DOR = DOL = V_{IL}$, $\overline{CE}_R = \overline{CE}_L = V_{IH}$, or both $\overline{UB} \& \overline{LB} = V_{IH}$.
2. All timing is the same for left and right port. Port "A" may be either left or right port. Port "B" is the opposite from port "A".
3. This parameter is measured from R/\overline{W}^A or \overline{SEM}^A going HIGH to R/\overline{W}^B or \overline{SEM}^B going HIGH.
4. If t_{SPS} is not satisfied, there is no guarantee which side will obtain the semaphore flag.

AC Electrical Characteristics Over the Operating Temperature Supply Voltage Range⁽⁶⁾

Symbol	Parameter	7025X15 Com'l Ony		7025X17 Com'l Only		7025X20 Com'l, Ind & Military		7025X25 Com'l & Military		Unit
		Min.	Max.	Min.	Max.	Min.	Max.	Min.	Max.	
BUSY TIMING ($M/\bar{S} = V_{IH}$)										
t _{BAA}	$\bar{B}US\bar{Y}$ Access Time from Address Match	—	15	—	17	—	20	—	20	ns
t _{BDA}	$\bar{B}US\bar{Y}$ Disable Time from Address Not Matched	—	15	—	17	—	20	—	20	ns
t _{BAC}	$\bar{B}US\bar{Y}$ Access Time from Chip Enable LOW	—	15	—	17	—	20	—	20	ns
t _{BDC}	$\bar{B}US\bar{Y}$ Disable Time from Chip Enable HIGH	—	15	—	17	—	17	—	17	ns
t _{APS}	Arbitration Priority Set-up Time ⁽²⁾	5	—	5	—	5	—	5	—	ns
t _{BDD}	$\bar{B}US\bar{Y}$ Disable to Valid Data ⁽³⁾	—	18	—	18	—	30	—	30	ns
t _{WH}	Write Hold After $\bar{B}US\bar{Y}$ ⁽⁵⁾	12	—	13	—	15	—	17	—	ns
BUSY TIMING ($M/\bar{S} = V_{IL}$)										
t _{WB}	$\bar{B}US\bar{Y}$ Input to Write ⁽⁴⁾	0	—	0	—	0	—	0	—	ns
t _{WH}	Write Hold After $\bar{B}US\bar{Y}$ ⁽⁵⁾	12	—	13	—	15	—	17	—	ns
PORT-TO-PORT DELAY TIMING										
t _{WDD}	Write Pulse to Data Delay ⁽¹⁾	—	30	—	30	—	45	—	50	ns
t _{DDD}	Write Data Valid to Read Data Delay ⁽¹⁾	—	25	—	25	—	35	—	35	ns

2683 tbl 14a

Symbol	Parameter	7025X35 Com'l & Military		7025X55 Com'l, Ind & Military		7025X70 Military Only		Unit
		Min.	Max.	Min.	Max.	Min.	Max.	
BUSY TIMING ($M/\bar{S} = V_{IH}$)								
t _{BAA}	$\bar{B}US\bar{Y}$ Access Time from Address Match	—	20	—	45	—	45	ns
t _{BDA}	$\bar{B}US\bar{Y}$ Disable Time from Address Not Matched	—	20	—	40	—	40	ns
t _{BAC}	$\bar{B}US\bar{Y}$ Access Time from Chip Enable LOW	—	20	—	40	—	40	ns
t _{BDC}	$\bar{B}US\bar{Y}$ Disable Time from Chip Enable HIGH	—	20	—	35	—	35	ns
t _{APS}	Arbitration Priority Set-up Time ⁽²⁾	5	—	5	—	5	—	ns
t _{BDD}	$\bar{B}US\bar{Y}$ Disable to Valid Data ⁽³⁾	—	35	—	40	—	45	ns
t _{WH}	Write Hold After $\bar{B}US\bar{Y}$ ⁽⁵⁾	25	—	25	—	25	—	ns
BUSY TIMING ($M/\bar{S} = V_{IL}$)								
t _{WB}	$\bar{B}US\bar{Y}$ Input to Write ⁽⁴⁾	0	—	0	—	0	—	ns
t _{WH}	Write Hold After $\bar{B}US\bar{Y}$ ⁽⁵⁾	25	—	25	—	25	—	ns
PORT-TO-PORT DELAY TIMING								
t _{WDD}	Write Pulse to Data Delay ⁽¹⁾	—	60	—	80	—	95	ns
t _{DDD}	Write Data Valid to Read Data Delay ⁽¹⁾	—	45	—	65	—	80	ns

2683 tbl 14b

NOTES:

1. Port-to-port delay through RAM cells from writing port to reading port, refer to "Timing Waveform of Write Port-to-Port Read and $\bar{B}US\bar{Y}$ ($M/\bar{S} = V_{IH}$)".
2. To ensure that the earlier of the two ports wins.
3. t_{BDD} is a calculated parameter and is the greater of 0ns, t_{WDD} – t_{WTP} (actual) or t_{DDD} – t_{TDW} (actual).
4. To ensure that the write cycle is inhibited on Port "B" during contention with Port "A".
5. To ensure that a write cycle is completed on Port "B" after contention with Port "A".
6. 'X' in part number indicates power rating (S or L).

Waveform of **BUSY** Arbitration Controlled by **CE** Timing⁽¹⁾ ($M/\bar{S} = V_{IH}$)

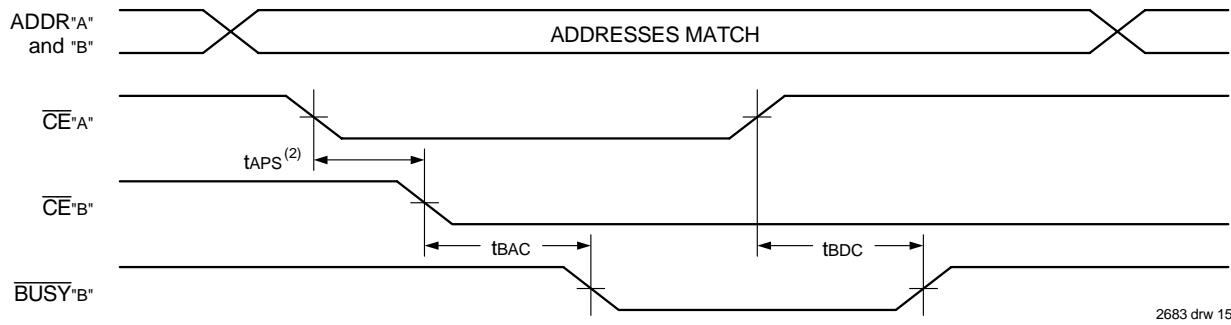

Waveform of **BUSY** Arbitration Cycle Controlled by Address Match Timing⁽¹⁾ ($M/\bar{S} = V_{IH}$)

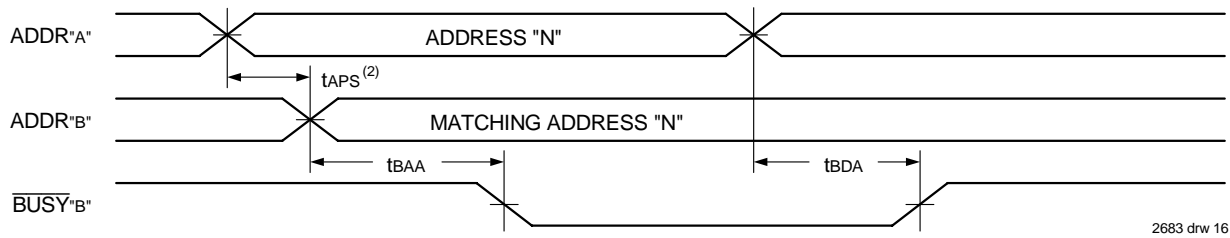

NOTES:

1. All timing is the same for left and right ports. Port "A" may be either the left or right port. Port "B" is the port opposite from "A".
2. If tAPS is not satisfied, the **BUSY** signal will be asserted on one side or another but there is no guarantee on which side **BUSY** will be asserted.

AC Electrical Characteristics Over the Operating Temperature and Supply Voltage Range⁽¹⁾

Symbol	Parameter	7025X15 Com'l Only		7025X17 Com'l Only		7025X20 Com'l, Ind & Military		7025X25 Com'l & Military		Unit
		Min.	Max.	Min.	Max.	Min.	Max.	Min.	Max.	
INTERRUPT TIMING										
tAS	Address Set-up Time	0	—	0	—	0	—	0	—	ns
tWR	Write Recovery Time	0	—	0	—	0	—	0	—	ns
tNS	Interrupt Set Time	—	15	—	15	—	20	—	20	ns
tNR	Interrupt Reset Time	—	15	—	15	—	20	—	20	ns

2683 tbl 15a

Symbol	Parameter	7025X35 Com'l & Military		7025X55 Com'l, Ind & Military		7025X70 Military Only		Unit
		Min.	Max.	Min.	Max.	Min.	Max.	
INTERRUPT TIMING								
tAS	Address Set-up Time	0	—	0	—	0	—	ns
tWR	Write Recovery Time	0	—	0	—	0	—	ns
tNS	Interrupt Set Time	—	25	—	40	—	50	ns
tNR	Interrupt Reset Time	—	25	—	40	—	50	ns

2683 tbl 15b

NOTES:

1. 'X' in part number indicates power rating (S or L).

Waveform of Interrupt Timing⁽¹⁾

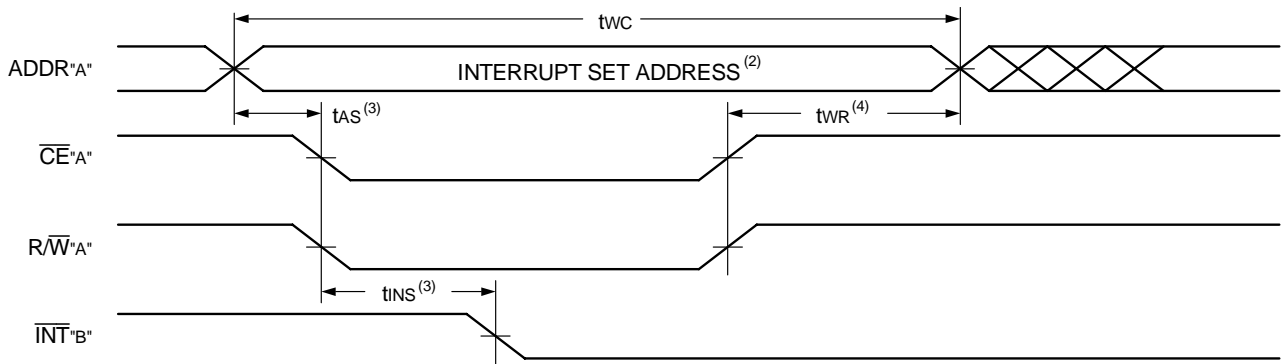

2683 drw 17

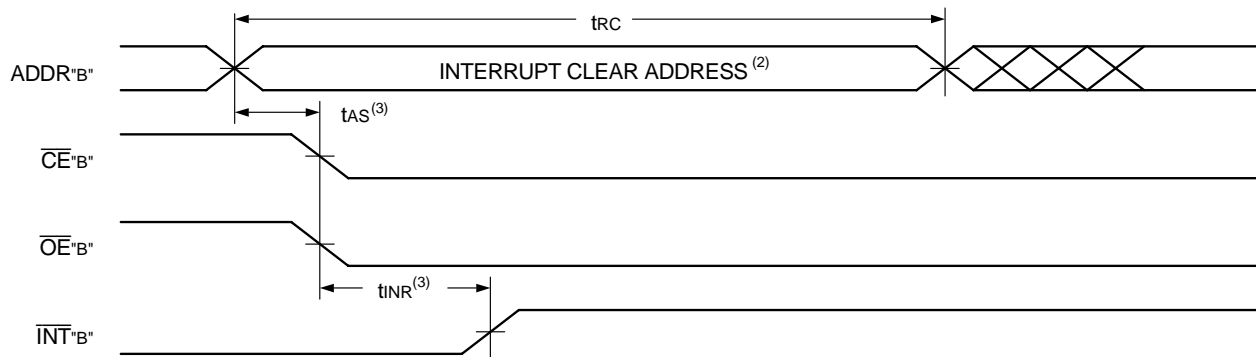

2683 drw 18

NOTES:

1. All timing is the same for left and right ports. Port "A" may be either the left or right port. Port "B" is the port opposite from "A".
2. See Interrupt Flag Truth Table.
3. Timing depends on which enable signal (\overline{CE} or R/\overline{W}) is asserted last.
4. Timing depends on which enable signal (\overline{CE} or R/\overline{W}) is de-asserted first.

Truth Tables

Truth Table I — Interrupt Flag⁽¹⁾

Left Port					Right Port					Function
R/ \overline{W}	\overline{CE} L	\overline{OE} L	A ₀ L-A ₁₂ L	\overline{INT} L	R/ \overline{W} R	\overline{CE} R	\overline{OE} R	A ₀ R-A ₁₂ R	\overline{INT} R	
L	L	X	1FFF	X	X	X	X	X	L ⁽²⁾	Set Right \overline{INT} R Flag
X	X	X	X	X	X	L	L	1FFF	H ⁽³⁾	Reset Right \overline{INT} R Flag
X	X	X	X	L ⁽³⁾	L	L	X	1FFE	X	Set Left \overline{INT} L Flag
X	L	L	1FFE	H ⁽²⁾	X	X	X	X	X	Reset Left \overline{INT} L Flag

2689 tbl 16

NOTES:

1. Assumes \overline{BUSY} L = \overline{BUSY} R = V_{IH}.
2. If \overline{BUSY} L = V_{IL}, then no change.
3. If \overline{BUSY} R = V_{IL}, then no change.
4. \overline{INT} R and \overline{INT} L must be initialized at power-up.

Truth Table II — Address **BUSY** Arbitration

Inputs			Outputs		Function
\overline{CE}_L	\overline{CE}_R	A _{0L} -A _{12L} A _{0R} -A _{12R}	$\overline{BUSY}_L^{(1)}$	$\overline{BUSY}_R^{(1)}$	
X	X	NO MATCH	H	H	Normal
H	X	MATCH	H	H	Normal
X	H	MATCH	H	H	Normal
L	L	MATCH	(2)	(2)	Write Inhibit ⁽³⁾

2683 tbl 17

NOTES:

1. Pins \overline{BUSY}_L and \overline{BUSY}_R are both outputs when the part is configured as a master. \overline{BUSY} are inputs when configured as a slave. \overline{BUSY}_x outputs on the IDT7025 are push pull, not open drain outputs. On slaves the \overline{BUSY} asserted internally inhibits write.
2. "L" if the inputs to the opposite port were stable prior to the address and enable inputs of this port. "H" if the inputs to the opposite port became stable after the address and enable inputs of this port. If t_{APSS} is not met, either \overline{BUSY}_L or \overline{BUSY}_R = LOW will result. \overline{BUSY}_L and \overline{BUSY}_R outputs cannot be LOW simultaneously.
3. Writes to the left port are internally ignored when \overline{BUSY}_L outputs are driving LOW regardless of actual logic level on the pin. Writes to the right port are internally ignored when \overline{BUSY}_R outputs are driving LOW regardless of actual logic level on the pin.

Truth Table III — Example of Semaphore Procurement Sequence^(1,2,3)

Functions	D ₀ - D ₁₅ Left	D ₀ - D ₁₅ Right	Status
No Action	1	1	Semaphore free
Left Port Writes "0" to Semaphore	0	1	Left port has semaphore token
Right Port Writes "0" to Semaphore	0	1	No change. Right side has no write access to semaphore
Left Port Writes "1" to Semaphore	1	0	Right port obtains semaphore token
Left Port Writes "0" to Semaphore	1	0	No change. Left port has no write access to semaphore
Right Port Writes "1" to Semaphore	0	1	Left port obtains semaphore token
Left Port Writes "1" to Semaphore	1	1	Semaphore free
Right Port Writes "0" to Semaphore	1	0	Right port has semaphore token
Right Port Writes "1" to Semaphore	1	1	Semaphore free
Left Port Writes "0" to Semaphore	0	1	Left port has semaphore token
Left Port Writes "1" to Semaphore	1	1	Semaphore free

2683 tbl 18

NOTES:

1. This table denotes a sequence of events for only one of the eight semaphores on the IDT7025.
2. There are eight semaphore flags written to via I/O₀ and read from all I/O's. These eight semaphores are addressed by A₀ - A₂.
3. $\overline{CE} = V_{IH}$, $\overline{SEM} = V_{IL}$, to access the semaphores. Refer to the Semaphore Read/Write Truth Table.

Functional Description

The IDT7025 provides two ports with separate control, address and I/O pins that permit independent access for reads or writes to any location in memory. The IDT7025 has an automatic power down feature controlled by \overline{CE} . The \overline{CE} controls on-chip power down circuitry that permits the respective port to go into a standby mode when not selected ($\overline{CE} = V_{IH}$). When a port is enabled, access to the entire memory array is permitted.

Interrupts

If the user chooses the interrupt function, a memory location (mail box or message center) is assigned to each port. The left port interrupt flag (\overline{INT}_L) is asserted when the right port writes to memory location 1FFE

(HEX), where a write is defined as the $\overline{CE}_R = R/\overline{W}_R = V_{IL}$ per Truth Table I. The left port clears the interrupt by an address location 1FFE access when $\overline{CE}_L = \overline{OE}_L = V_{IL}$, R/\overline{W}_L is a "don't care". Likewise, the right port interrupt flag (\overline{INT}_R) is asserted when the left port writes to memory location 1FFF (HEX) and to clear the interrupt flag (\overline{INT}_R), the right port must access the memory location 1FFF. The message (16 bits) at 1FFE or 1FFF is user-defined, since it is an addressable SRAM location. If the interrupt function is not used, address locations 1FFE and 1FFF are not used as mail boxes, but as part of the random access memory. Refer to Truth Table I for the interrupt operation.

that semaphore's status or remove its request for that semaphore to perform another task and occasionally attempt again to gain control of the token via the set and test sequence. Once the right side has relinquished the token, the left side should succeed in gaining control.

The semaphore flags are active LOW. A token is requested by writing a zero into a semaphore latch and is released when the same side writes a one to that latch.

The eight semaphore flags reside within the IDT7025 in a separate memory space from the Dual-Port RAM. This address space is accessed by placing a LOW input on the $\overline{\text{SEM}}$ pin (which acts as a chip select for the semaphore flags) and using the other control pins (Address, $\overline{\text{OE}}$, and R/W) as they would be used in accessing a standard Static RAM. Each of the flags has a unique address which can be accessed by either side through address pins A0–A2. When accessing the semaphores, none of the other address pins has any effect.

When writing to a semaphore, only data pin Do is used. If a LOW level is written into an unused semaphore location, that flag will be set to a zero on that side and a one on the other side (see Truth Table III). That semaphore can now only be modified by the side showing the zero. When a one is written into the same location from the same side, the flag will be set to a one for both sides (unless a semaphore request from the other side is pending) and then can be written to by both sides. The fact that the side which is able to write a zero into a semaphore subsequently locks out writes from the other side is what makes semaphore flags useful in interprocessor communications. (A thorough discussion on the use of this feature follows shortly.) A zero written into the same location from the other side will be stored in the semaphore request latch for that side until the semaphore is freed by the first side.

When a semaphore flag is read, its value is spread into all data bits so that a flag that is a one reads as a one in all data bits and a flag containing a zero reads as all zeros. The read value is latched into one side's output register when that side's semaphore select ($\overline{\text{SEM}}$) and output enable ($\overline{\text{OE}}$) signals go active. This serves to disallow the semaphore from changing state in the middle of a read cycle due to a write cycle from the other side. Because of this latch, a repeated read of a semaphore in a test loop must cause either signal ($\overline{\text{SEM}}$ or $\overline{\text{OE}}$) to go inactive or the output will never change.

A sequence WRITE/READ must be used by the semaphore in order to guarantee that no system level contention will occur. A processor requests access to shared resources by attempting to write a zero into a semaphore location. If the semaphore is already in use, the semaphore request latch will contain a zero, yet the semaphore flag will appear as one, a fact which the processor will verify by the subsequent read (see Truth Table III). As an example, assume a processor writes a zero to the left port at a free semaphore location. On a subsequent read, the processor will verify that it has written successfully to that location and will assume control over the resource in question. Meanwhile, if a processor on the right side attempts to write a zero to the same semaphore flag it will fail, as will be verified by the fact that a one will be read from that semaphore on the right side during subsequent read. Had a sequence of READ/WRITE been used instead, system contention problems could have occurred during the gap between the read and write cycles.

It is important to note that a failed semaphore request must be followed by either repeated reads or by writing a one into the same location. The reason for this is easily understood by looking at the simple logic diagram of the semaphore flag in Figure 4. Two semaphore request latches feed

into a semaphore flag. Whichever latch is first to present a zero to the semaphore flag will force its side of the semaphore flag LOW and the other side HIGH. This condition will continue until a one is written to the same semaphore request latch. Should the other side's semaphore request latch have been written to a zero in the meantime, the semaphore flag will flip over to the other side as soon as a one is written into the first side's request latch. The second side's flag will now stay LOW until its semaphore request latch is written to a one. From this it is easy to understand that, if a semaphore is requested and the processor which requested it no longer needs the resource, the entire system can hang up until a one is written into that semaphore request latch.

The critical case of semaphore timing is when both sides request a single token by attempting to write a zero into it at the same time. The semaphore logic is specially designed to resolve this problem. If simultaneous requests are made, the logic guarantees that only one side receives the token. If one side is earlier than the other in making the request, the first side to make the request will receive the token. If both requests arrive at the same time, the assignment will be arbitrarily made to one port or the other.

One caution that should be noted when using semaphores is that semaphores alone do not guarantee that access to a resource is secure. As with any powerful programming technique, if semaphores are misused or misinterpreted, a software error can easily happen.

Initialization of the semaphores is not automatic and must be handled via the initialization program at power-up. Since any semaphore request flag which contains a zero must be reset to a one, all semaphores on both sides should have a one written into them at initialization from both sides to assure that they will be free when needed.

Using Semaphores—Some Examples

Perhaps the simplest application of semaphores is their application as resource markers for the IDT7025's Dual-Port RAM. Say the 8K x 16 RAM was to be divided into two 4K x 16 blocks which were to be dedicated at any one time to servicing either the left or right port. Semaphore 0 could be used to indicate the side which would control the lower section of memory, and Semaphore 1 could be defined as the indicator for the upper section of memory.

To take a resource, in this example the lower 4K of Dual-Port RAM, the processor on the left port could write and then read a zero in to Semaphore 0. If this task were successfully completed (a zero was read back rather than a one), the left processor would assume control of the lower 4K. Meanwhile the right processor was attempting to gain control of the resource after the left processor, it would read back a one in response to the zero it had attempted to write into Semaphore 0. At this point, the software could choose to try and gain control of the second 4K section by writing, then reading a zero into Semaphore 1. If it succeeded in gaining control, it would lock out the left side.

Once the left side was finished with its task, it would write a one to Semaphore 0 and may then try to gain access to Semaphore 1. If Semaphore 1 was still occupied by the right side, the left side could undo its semaphore request and perform other tasks until it was able to write, then read a zero into Semaphore 1. If the right processor performs a similar task with Semaphore 0, this protocol would allow the two processors to swap 4K blocks of Dual-Port RAM with each other.

The blocks do not have to be any particular size and can even be

variable, depending upon the complexity of the software using the semaphore flags. All eight semaphores could be used to divide the Dual-Port RAM or other shared resources into eight parts. Semaphores can even be assigned different meanings on different sides rather than being given a common meaning as was shown in the example above.

Semaphores are a useful form of arbitration in systems like disk interfaces where the CPU must be locked out of a section of memory during a transfer and the I/O device cannot tolerate any wait states. With the use of semaphores, once the two devices has determined which memory area was "off-limits" to the CPU, both the CPU and the I/O devices could access their assigned portions of memory continuously without any wait states.

Semaphores are also useful in applications where no memory "WAIT" state is available on one or both sides. Once a semaphore handshake has

been performed, both processors can access their assigned RAM segments at full speed.

Another application is in the area of complex data structures. In this case, block arbitration is very important. For this application one processor may be responsible for building and updating a data structure. The other processor then reads and interprets that data structure. If the interpreting processor reads an incomplete data structure, a major error condition may exist. Therefore, some sort of arbitration must be used between the two different processors. The building processor arbitrates for the block, locks it and then is able to go in and update the data structure. When the update is completed, the data structure block is released. This allows the interpreting processor to come back and read the complete data structure, thereby guaranteeing a consistent data structure.



2683 drw 20

Figure 4. IDT7025 Semaphore Logic

Ordering Information



2683 drw 21

NOTES:

- Industrial range is available on selected PLCC packages in standard power.
 For other speeds, packages and powers contact your sales office.
LEAD FINISH (SnPb) parts are in EOL process. Product Discontinuation Notice - PDN# SP-17-02

Datasheet Document History

- 01/13/99: Initiated datasheet document history
 Converted to new format
 Cosmetic and typographical corrections
 Pages 2 and 3 Added additional notes to pin configurations
- 05/19/99: Page 11 Fixed typographical error
- 06/03/99: Changed drawing format
 Page 1 Corrected DSC number
- 04/04/00: Replaced IDT logo
 Page 7 Fixed typo in Data Retention chart
 Changed ±500mV to 0mV in notes
- 05/22/00: Page 5 Increased storage temperature parameter
 Clarified TA parameter
 Page 6 DC Electrical parameters—changed wording from "open" to "disabled"
- 09/13/01: Page 2 & 3 Added date revision for pin configurations
 Page 6 Added Industrial temp to the column heading for 20ns to DC Electrical Characteristics
 Pages 8,10,13&15 Added Industrial temp to the column headings for 20ns to AC Electrical Characteristics
 Pages 5,6,8,10,13&15 Removed Industrial temp footnote from all tables
 Page 21 Added Industrial temp to 20ns in ordering information
- 10/21/08: Page 22 Removed "IDT" from orderable part number
- 07/17/12: Page 22 Added T&R and green indicators to ordering information
- 03/07/18: Product Discontinuation Notice - PDN# SP-17-02
 Last time buy expires June 15, 2018



CORPORATE HEADQUARTERS
 6024 Silver Creek Valley Road
 San Jose, CA 95138

for SALES:
 800-345-7015 or 408-284-8200
 fax: 408-284-2775
 www.idt.com

for Tech Support:
 408-284-2794
 DualPortHelp@idt.com

The IDT logo is a registered trademark of Integrated Device Technology, Inc.

Mouser Electronics

Authorized Distributor

Click to View Pricing, Inventory, Delivery & Lifecycle Information:

[IDT \(Integrated Device Technology\):](#)

[7025L17PF8](#) [7025L20PFGI](#) [5962-9161702MXA](#) [5962-9161702MYA](#) [7025L55GB](#) [7025L55PF](#) [7025L55FB](#)
[7025L20JG18](#) [7025L15PF8](#) [7025L15JG8](#) [7025S20PF8](#) [7025S35G](#) [7025S35J](#) [7025S30J](#) [7025L15PFG8](#) [7025S45J8](#)
[7025S55J1](#) [7025S55FB](#) [7025S55PF](#) [7025S55GB](#) [7025S20G](#) [7025S20J](#) [7025S55G](#) [7025S55J](#) [5962-9161706MXA](#)
[7025S45J](#) [7025L17PF](#) [7025S25G](#) [7025S25J](#) [7025L15PF](#) [7025S17J](#) [7025S17G](#) [7025S15J](#) [7025L15JG](#)
[7025L45PF](#) [7025S17PF](#) [7025L45J8](#) [7025L55PF8](#) [7025S17J8](#) [7025S15J8](#) [7025L20PF8](#) [7025L20J18](#) [5962-](#)
[9161705MXA](#) [7025L25J8](#) [7025L45PF8](#) [7025L20J8](#) [7025L20PFG18](#) [7025S20J8](#) [7025L20PFI8](#) [7025S25J8](#)
[7025L15PFG](#) [7025L35GB](#) [7025L35FB](#) [7025L35PF](#) [7025S35GB](#) [7025S35FB](#) [7025S35PF](#) [7025L70FB](#) [7025L70GB](#)
[7025L35PF8](#) [5962-9161708MYA](#) [5962-9161708MXA](#) [7025L25PF8](#) [7025L25J](#) [7025L25G](#) [7025L20J](#) [7025L20G](#)
[7025L20JG1](#) [7025S35PF8](#) [7025L30J](#) [7025L45J](#) [7025L35J](#) [7025L35G](#) [7025L35J8](#) [7025L20PFI](#) [7025L17G](#)
[7025L15J](#) [7025L17J](#) [7025L55G](#) [7025L55J](#) [7025L30J8](#) [7025L20FB](#) [7025L20J1](#) [7025L20PF](#) [7025L25GB](#)
[7025L25FB](#) [7025L25PF](#) [7025L55J8](#) [5962-9161701MXA](#) [7025S25PF](#) [7025S20PF](#) [7025S45PF8](#) [7025S25GB](#)
[7025S17PF8](#) [7025L15J8](#) [7025S55J8](#) [7025S25PF8](#) [7025L17J8](#) [7025S70GB](#) [5962-9161704MXA](#)

Данный компонент на территории Российской Федерации

Вы можете приобрести в компании MosChip.

Для оперативного оформления запроса Вам необходимо перейти по данной ссылке:

<http://moschip.ru/get-element>

Вы можете разместить у нас заказ для любого Вашего проекта, будь то серийное производство или разработка единичного прибора.

В нашем ассортименте представлены ведущие мировые производители активных и пассивных электронных компонентов.

Нашей специализацией является поставка электронной компонентной базы двойного назначения, продукции таких производителей как XILINX, Intel (ex.ALTERA), Vicor, Microchip, Texas Instruments, Analog Devices, Mini-Circuits, Amphenol, Glenair.

Сотрудничество с глобальными дистрибьюторами электронных компонентов, предоставляет возможность заказывать и получать с международных складов практически любой перечень компонентов в оптимальные для Вас сроки.

На всех этапах разработки и производства наши партнеры могут получить квалифицированную поддержку опытных инженеров.

Система менеджмента качества компании отвечает требованиям в соответствии с ГОСТ Р ИСО 9001, ГОСТ РВ 0015-002 и ЭС РД 009

Офис по работе с юридическими лицами:

105318, г.Москва, ул.Щербаковская д.3, офис 1107, 1118, ДЦ «Щербаковский»

Телефон: +7 495 668-12-70 (многоканальный)

Факс: +7 495 668-12-70 (доб.304)

E-mail: info@moschip.ru

Skype отдела продаж:

moschip.ru

moschip.ru_4

moschip.ru_6

moschip.ru_9