



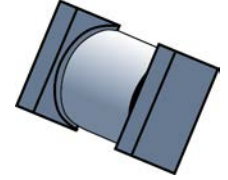
## Voidless Hermetically Sealed Surface Mount Bidirectional Transient Voltage Suppressors

Qualified to MIL-PRF-19500/516

*Qualified Levels:  
JAN, JANTX, JANTXV  
and JANS*

### DESCRIPTION

This surface mount series of industry recognized voidless, hermetically sealed, bidirectional Transient Voltage Suppressor (TVS) designs are military qualified to MIL-PRF-19500/516 and are ideal for high-reliability applications where a failure cannot be tolerated. They provide a working peak “standoff” voltage selection from 5.2 to 152 volts with a 1500 watt rating for a 10/1000 us pulse. They are very robust in hard-glass construction and use internal Category 1 metallurgical bonds for high reliability. These are also available as both a non suffix part and an “A” version part involving different voltage tolerances as further described in the [nomenclature](#) section. These devices are also available in axial-leaded packages for thru-hole mounting.



**“C” or SQ-MELF  
Package**

**Important:** For the latest information, visit our website <http://www.microsemi.com>.


Also available in:

### FEATURES

- High surge current and peak pulse power provides transient voltage protection for sensitive circuits
- Triple-layer passivation
- Internal “Category 1” metallurgical bonds
- Voidless hermetically sealed glass package
- JAN, JANTX, JANTXV and JANS qualified versions are available per MIL-PRF-19500/516. (See [part nomenclature](#) for all available options.)
- RoHS compliant versions available (commercial grade only)

**“C” Package**

(axial-leaded)

 [1N6138 – 1N6173](#)

### APPLICATIONS / BENEFITS

- Military and other high-reliability applications
- Extremely robust construction
- Extensive range in working peak “standoff” voltage ( $V_{WM}$ ) from 5.2 to 152 volts
- 1500 watt peak pulse power ( $P_{PP}$ ) for a 10/1000 us pulse
- ESD and EFT protection per IEC6100-4-2 and IEC61000-4-4 respectively
- Protection from the secondary effects of lightning per select levels in IEC61000-4-5
- Square-end-cap terminals for easy placement
- Non-sensitive to ESD per MIL-STD-750 method 1020
- Inherently radiation hard as described in Microsemi “[MicroNote 050](#)”

### MAXIMUM RATINGS @ $T_A = 25^\circ\text{C}$ unless otherwise noted.

Parameters/Test Conditions	Symbol	Value	Unit
Junction and Storage Temperature	$T_J$ and $T_{STG}$	-55 to +175	$^\circ\text{C}$
Thermal Resistance Junction-to-End Cap	$R_{\theta JEC}$	5.0	$^\circ\text{C/W}$
Peak Pulse Power @ $25^\circ\text{C}$ (10/1000 $\mu\text{s}$ )	$P_{PP}$	1500	W
Off-State Power up to $T_{EC} = 150^\circ\text{C}$ <sup>(1)</sup>	$P_D$	5.0	W
Off-State Power @ $T_A = 25^\circ\text{C}$ <sup>(2)</sup>	$P_D$	3.0	W
Impulse Repetition Rate	df	0.01	%
Solder Temperature @ 10 s	$T_{SP}$	260	$^\circ\text{C}$

- Notes:**
1. Linearly derate above  $T_{EC} = 150^\circ\text{C}$  to zero at  $T_{EC} = 175^\circ\text{C}$ .
  2. Steady-state power ratings with reference to ambient are for PC boards where thermal resistance from mounting point to ambient is sufficiently controlled where  $T_{OP}$  or  $T_{J(MAX)}$  is not exceeded (also see [figure 6](#)).

**MSC – Lawrence**

6 Lake Street,  
Lawrence, MA 01841  
Tel: 1-800-446-1158 or  
(978) 620-2600  
Fax: (978) 689-0803

**MSC – Ireland**

Gort Road Business Park,  
Ennis, Co. Clare, Ireland  
Tel: +353 (0) 65 6840044  
Fax: +353 (0) 65 6822298

**Website:**

[www.microsemi.com](http://www.microsemi.com)

**MECHANICAL and PACKAGING**

- CASE: Hermetically sealed voidless hard glass with tungsten slugs
- TERMINALS: Tin/lead plate over copper. RoHS compliant matte-tin is available on commercial grade only.
- MARKING: None
- POLARITY: No polarity marking for these bidirectional TVSs
- TAPE & REEL option: Standard per EIA-481-B. Consult factory for quantities.
- WEIGHT: Approximately 1100 milligrams
- See [package dimensions](#) on last page.

**PART NOMENCLATURE**

**JAN 1N6138 A US e3**

**Reliability Level**

JAN = JAN Level  
 JANTX = JANTX Level  
 JANTXV = JANTXV Level  
 JANS = JANS level  
 Blank = commercial

**JEDEC type number**

See [Electrical Characteristics](#) table

**RoHS Compliance**

e3 = RoHS compliant (available on commercial grade only)  
 Blank = non-RoHS compliant

**Surface Mount Package**
**Voltage Tolerance**

A = Standard  
 Blank = 5% higher  $V_C$ , 5% lower min.  $V_{(BR)}$  and 5% lower  $I_{PP}$

**SYMBOLS & DEFINITIONS**

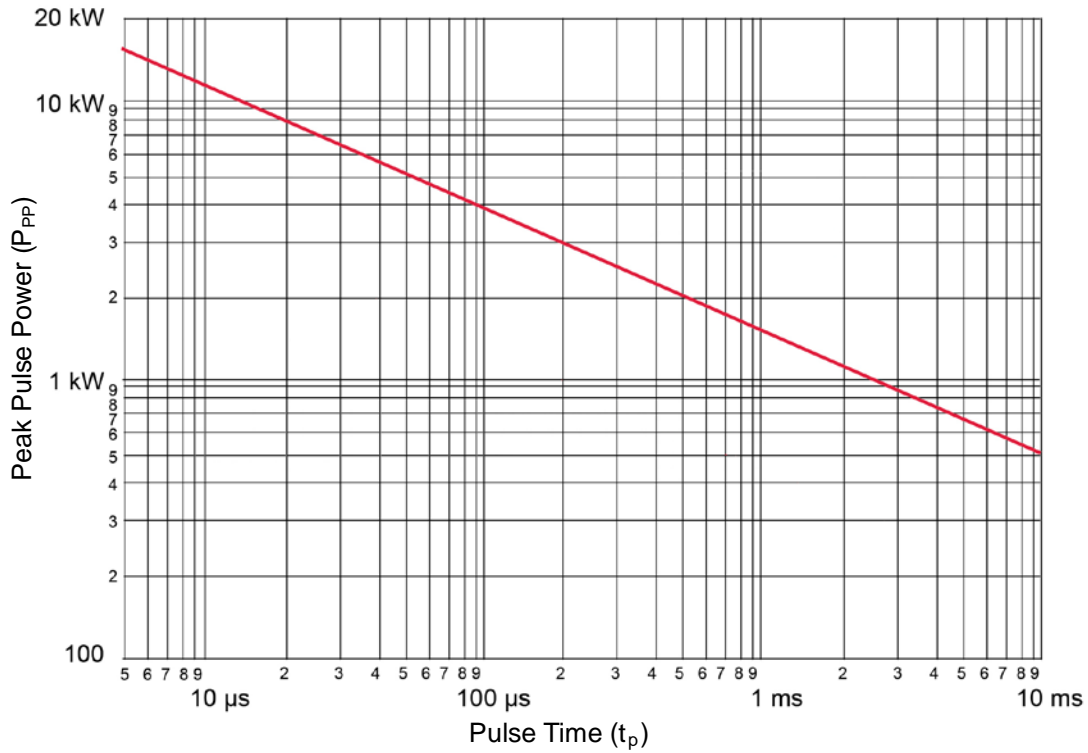
Symbol	Definition
$\alpha_{V(BR)}$	Temperature Coefficient of Breakdown Voltage: The change in breakdown voltage divided by the change in temperature that caused it expressed in %/°C or mV/°C.
$V_{(BR)}$	Breakdown Voltage: The voltage across the device at a specified current $I_{(BR)}$ in the breakdown region.
$V_{WM}$	Working Standoff Voltage: The maximum-rated value of dc or repetitive peak positive cathode-to-anode voltage that may be continuously applied over the standard operating temperature.
$I_D$	Standby Current: The current through the device at rated stand-off voltage.
$V_C$	Clamping Voltage: The voltage across the device in a region of low differential resistance during the application of an impulse current ( $I_{PP}$ ) for a specified waveform.
$P_{PP}$	Peak Pulse Power. The rated random recurring peak impulse power or rated nonrepetitive peak impulse power. The impulse power is the maximum-rated value of the product of $I_{PP}$ and $V_C$ .

**ELECTRICAL CHARACTERISTICS**

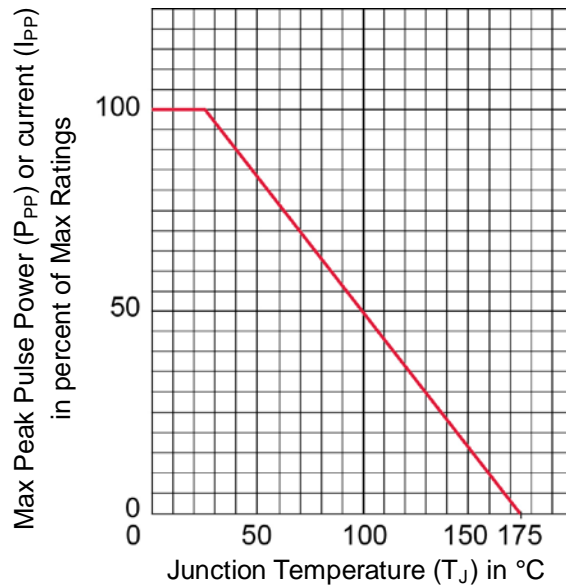
INDUSTRY TYPE NUMBER (Note 1)	MINIMUM BREAKDOWN VOLTAGE (Note 1)		RATED STANDOFF VOLTAGE	MAXIMUM STANDBY CURRENT	MAXIMUM CLAMPING VOLTAGE (Note 1)	MAXIMUM PEAK PULSE CURRENT (Note 1)	MAXIMUM TEMP. COEF. OF $V_{(BR)}$ $\alpha V_{(BR)}$
	$V_{(BR)}$	@ $I_{(BR)}$					
	Volts	mA	V	$\mu A$	Volts	Amps	$\%/^{\circ}C$
1N6138AUS	6.46	175	5.2	500	10.5	142.8	0.05
1N6139AUS	7.13	175	5.7	300	11.2	133.9	0.06
1N6140AUS	7.79	150	6.2	100	12.1	124.0	0.06
1N6141AUS	8.65	150	6.9	100	13.4	111.9	0.06
1N6142AUS	9.50	125	7.6	100	14.5	103.4	0.07
1N6143AUS	10.45	125	8.4	20	15.6	96.2	0.07
1N6144AUS	11.40	100	9.1	20	16.9	88.8	0.07
1N6145AUS	12.35	100	9.9	20	18.2	82.4	0.08
1N6146AUS	14.25	75	11.4	20	21.0	71.4	0.08
1N6147AUS	15.20	75	12.2	20	22.3	67.3	0.08
1N6148AUS	17.10	65	13.7	10	25.1	59.8	0.085
1N6149AUS	19.0	65	15.2	5	27.7	54.2	0.085
1N6150AUS	20.9	50	16.7	5	30.5	49.2	0.085
1N6151AUS	22.8	50	18.2	5	33.3	45.0	0.09
1N6152AUS	25.7	50	20.6	5	37.4	40.1	0.09
1N6153AUS	28.5	40	22.8	5	41.6	36.0	0.09
1N6154AUS	31.4	40	25.1	5	45.7	32.8	0.095
1N6155AUS	34.2	30	27.4	5	49.9	30.1	0.095
1N6156AUS	37.1	30	29.7	5	53.6	28.0	0.095
1N6157AUS	40.9	30	32.7	5	59.1	25.4	0.095
1N6158AUS	44.7	25	35.8	5	64.6	23.2	0.095
1N6159AUS	48.5	25	38.8	5	70.1	21.4	0.095
1N6160AUS	53.2	20	42.6	5	77.0	19.5	0.095
1N6161AUS	58.9	20	47.1	5	85.3	17.6	0.100
1N6162AUS	64.6	20	51.7	5	97.1	15.4	0.100
1N6163AUS	71.3	20	56.0	5	103.1	14.5	0.100
1N6164AUS	77.9	15	62.2	5	112.8	13.3	0.100
1N6165AUS	86.5	15	69.2	5	125.1	12.0	0.100
1N6166AUS	95.0	12	76.0	5	137.6	10.9	0.100
1N6167AUS	104.5	12	86.6	5	151.3	9.9	0.100
1N6168AUS	114.0	10	91.2	5	165.1	9.1	0.100
1N6169AUS	123.5	10	98.8	5	178.8	8.4	0.105
1N6170AUS	142.5	8	114.0	5	206.3	7.3	0.105
1N6171AUS	152.0	8	121.6	5	218.4	6.9	0.105
1N6172AUS	171.0	5	136.8	5	245.7	6.1	0.110
1N6173AUS	190.0	5	152.0	5	273.0	5.5	0.110

**Notes:** 1. Part number without the A suffix has 5% higher  $V_C$ , 5% lower minimum  $V_{(BR)}$ , and 5% lower  $I_{PP}$ .

GRAPHS

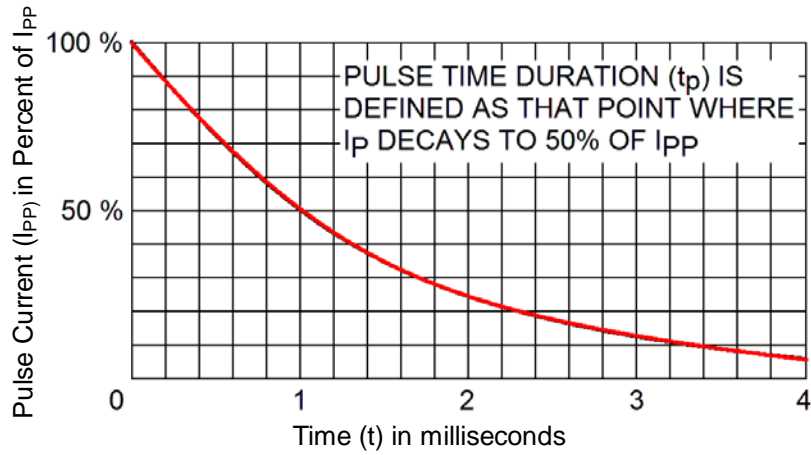


**FIGURE 1**  
Peak Pulse Power vs. Pulse Time

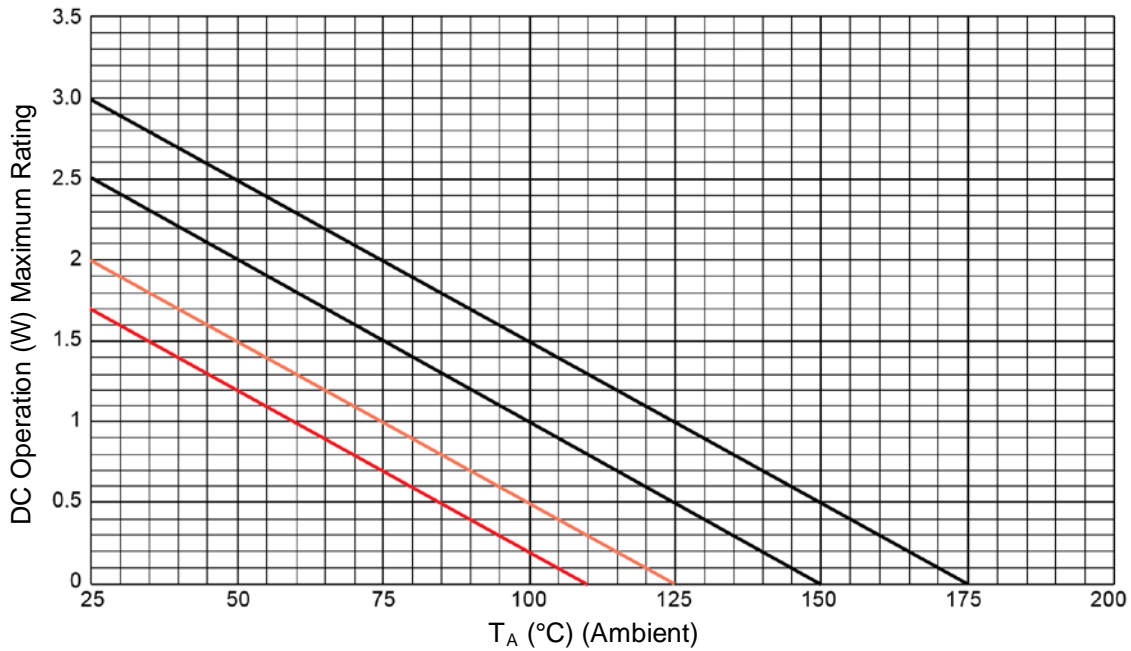


**FIGURE 2**  
Peak Pulse Power vs  $T_J$  (prior to impulse)

GRAPHS

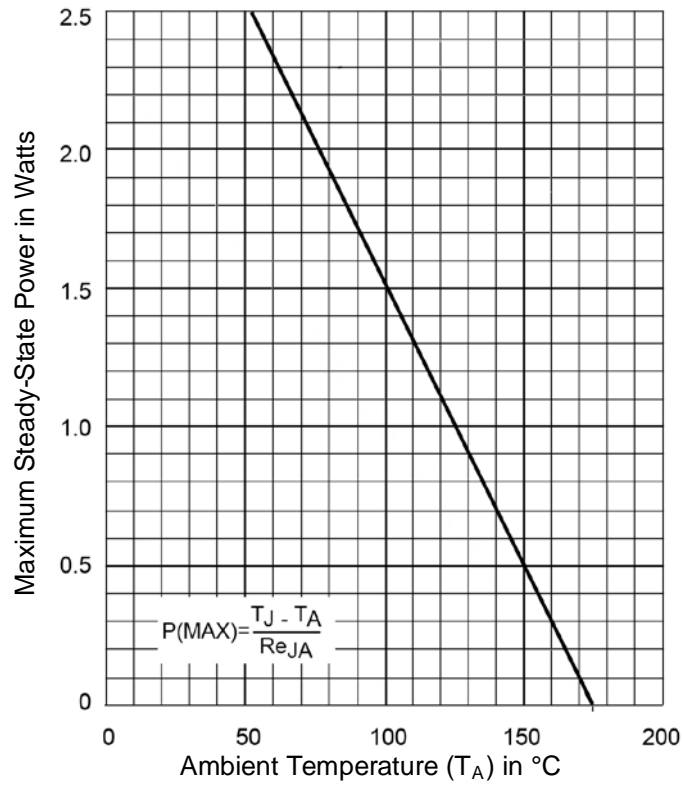


**FIGURE 3**  
Pulse Wave Form

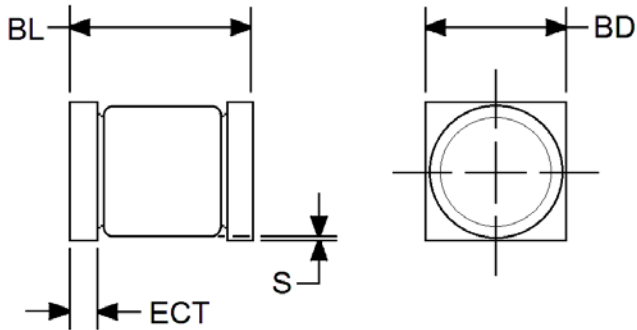


**FIGURE 4**  
Temperature-Power Derating Curve

GRAPHS



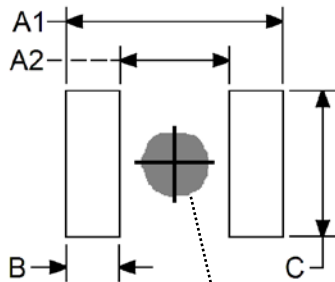
**FIGURE 5**  
Steady-State Derating Curve for Free-Air Mounting ( $R_{\theta JA} = 50 \text{ }^\circ\text{C/W}$ )

**PACKAGE DIMENSIONS**


Ltr	Dimensions				Notes
	Inch		Millimeters		
	Min	Max	Min	Max	
<b>BD</b>	0.183	0.202	4.65	5.13	
<b>BL</b>	0.205	0.245	5.21	6.22	
<b>ECT</b>	0.019	0.028	0.48	0.71	
<b>S</b>	0.003	-	0.08	-	4

**NOTES:**

1. Dimensions are in inches.
2. Millimeters are given for general information only.
3. Minimum clearance of glass body to mounting surface on all orientations.
4. In accordance with ASME Y14.5M, diameters are equivalent to  $\Phi$ x symbology.

**PAD LAYOUT**


DIM	INCH	MILLIMETERS
<b>A1</b>	0.310	7.87
<b>A2</b>	0.170	4.32
<b>B</b>	0.070	1.78
<b>C</b>	0.205	5.21

**NOTE:** If mounting requires adhesive separate from the solder, an additional 0.090 inch (2.29 mm) diameter contact may be placed in the center between the pads as an optional spot for cement.

# Mouser Electronics

Authorized Distributor

Click to View Pricing, Inventory, Delivery & Lifecycle Information:

## Microchip:

[JANS1N6172AUS](#) [JAN1N6150US](#) [JAN1N6155US](#) [JANS1N6144](#) [JAN1N6145US](#) [JAN1N6160US](#) [JANS1N6151](#)  
[JANS1N6162](#) [JANS1N6147AUS](#) [JANS1N6165A](#) [JAN1N6166US](#) [JAN1N6152US](#) [JAN1N6171US](#) [JANS1N6140AUS](#)  
[JAN1N6153US](#) [JANS1N6170](#) [JANS1N6160](#) [JANS1N6156AUS](#) [JANS1N6159](#) [JANS1N6143A](#) [JANTXV1N6146US](#)  
[JANS1N6141AUS](#) [JANS1N6161](#) [JANS1N6157](#) [JAN1N6138US](#) [JANS1N6151A](#) [JAN1N6143US](#) [JANS1N6169AUS](#)  
[JANS1N6172](#) [JANS1N6153](#) [JAN1N6156US](#) [JANS1N6146AUS](#) [JANS1N6150](#) [JANS1N6144US](#) [JAN1N6149US](#)  
[JANS1N6156](#) [JAN1N6165US](#) [JAN1N6142US](#) [JANS1N6145A](#) [JANS1N6164A](#) [JAN1N6147US](#) [JANS1N6154A](#)  
[JAN1N6168US](#) [JAN1N6161US](#) [JANS1N6149A](#) [JANTX1N6146US](#) [JANS1N6150A](#) [JANS1N6145AUS](#) [JAN1N6140US](#)  
[JANS1N6167](#) [JANS1N6142](#) [JANS1N6163AUS](#) [JANS1N6165AUS](#) [JANS1N6162A](#) [JANS1N6149](#) [JAN1N6151US](#)  
[JANS1N6168AUS](#) [JANTXV1N6173US](#) [JANTX1N6153US](#) [JANS1N6150AUS](#) [JANS1N6163](#) [JANTX1N6173US](#)  
[JAN1N6157US](#) [JANS1N6171](#) [JANS1N6148](#) [JANS1N6171A](#) [JANS1N6158](#) [JAN1N6173US](#) [JANS1N6154AUS](#)  
[JAN1N6146US](#) [JANS1N6149AUS](#) [JAN1N6172US](#) [JANS1N6153A](#) [JANS1N6141](#) [JANS1N6152](#) [JANS1N6166A](#)  
[JAN1N6144US](#) [JANS1N6169](#) [JANS1N6152A](#) [JAN1N6148US](#) [JANS1N6160AUS](#) [JANS1N6171AUS](#)  
[JANS1N6143AUS](#) [JANS1N6163A](#) [JANS1N6153AUS](#) [JANS1N6168](#) [JANS1N6140](#) [JANS1N6166](#) [JANS1N6155](#)  
[JANS1N6140A](#) [JANS1N6146A](#) [JAN1N6169US](#) [JAN1N6162US](#) [JANS1N6154](#) [JAN1N6163US](#) [JANS1N6169A](#)  
[JANS1N6158A](#) [JAN1N6139US](#) [JAN1N6167US](#) [JANS1N6162AUS](#)



## Данный компонент на территории Российской Федерации

### Вы можете приобрести в компании MosChip.

Для оперативного оформления запроса Вам необходимо перейти по данной ссылке:

<http://moschip.ru/get-element>

Вы можете разместить у нас заказ для любого Вашего проекта, будь то серийное производство или разработка единичного прибора.

В нашем ассортименте представлены ведущие мировые производители активных и пассивных электронных компонентов.

Нашей специализацией является поставка электронной компонентной базы двойного назначения, продукции таких производителей как XILINX, Intel (ex.ALTERA), Vicor, Microchip, Texas Instruments, Analog Devices, Mini-Circuits, Amphenol, Glenair.

Сотрудничество с глобальными дистрибьюторами электронных компонентов, предоставляет возможность заказывать и получать с международных складов практически любой перечень компонентов в оптимальные для Вас сроки.

На всех этапах разработки и производства наши партнеры могут получить квалифицированную поддержку опытных инженеров.

Система менеджмента качества компании отвечает требованиям в соответствии с ГОСТ Р ИСО 9001, ГОСТ РВ 0015-002 и ЭС РД 009

### Офис по работе с юридическими лицами:

105318, г.Москва, ул.Щербаковская д.3, офис 1107, 1118, ДЦ «Щербаковский»

Телефон: +7 495 668-12-70 (многоканальный)

Факс: +7 495 668-12-70 (доб.304)

E-mail: [info@moschip.ru](mailto:info@moschip.ru)

Skype отдела продаж:

moschip.ru

moschip.ru\_4

moschip.ru\_6

moschip.ru\_9