



Espressif

Production Testing Guide



Version 1.0
Espressif Systems
Copyright © 2018



About This Guide

This guide mainly describes the production testing schemes available for Espressif Wi-Fi products (Wi-Fi module/Chip Onboard), thus providing reference for the production testing of customer products.

Release Notes

Date	Version	Release notes
2018.09	V1.0	Initial Release.

Documentation Change Notification

Espressif provides email notifications to keep customers updated on changes to technical documentation. Please subscribe at <https://www.espressif.com/en/subscribe>.

Certification

Download certificates for Espressif products from <https://www.espressif.com/en/certificates>.

Table of Contents

1. Introduction	1
1.1. RF General-purpose Tester Scheme	1
1.2. Signal Board Scheme	2
1.3. Production Testing Process	3
1.4. Related Equipments for Production Testing	4
1.4.1. Serial Port Board	4
1.4.2. Test Fixture	5
1.4.3. Signal Board	6
1.5. Scheme Comparison	7
2. Environment Setup	9
2.1. Testing Package	9
2.2. Test Step	9
3. Production Testing Tool	12
3.1. Tool Introduction	12
3.1.1. Directory	12
3.1.2. Interface	12
3.1.3. Test Mode	13
3.2. Tool Configuration	14
3.2.1. Interface	14
3.2.2. TEST CONFIG	14
3.2.3. DUT CONFIG	15
3.3. Test Flow	15
3.3.1. RF Test	15
3.3.2. GPIO Conductivity Test	16
3.3.3. Firmware Version Verification Test	16
3.3.4. Flash-related Test	17
3.4. Tool Operation	18
A. Appendix – FAQ	21
A.1. Why it is necessary to set up an evaluating environment?	21
A.2. Why the signal received by my DUT is excessively strong?	21
A.3. Working life and range of signal Board	21

B. Appendix – GPIO Conductivity Test Configuration	22
B.1. GPIO Conductivity Test Configuration for ESP32	22
B.2. GPIO Conductivity Test Configuration for ESP8266	24
C. Appendix – Firmware Version Verification Test	26
D. Appendix – Jump Test Configuration.....	27



1.

Introduction

Generally, there are two production testing schemes available to test the RF performance of the Wi-Fi products based on Espressif IC:

- RF General-purpose Tester Scheme (general standard in the industry);
- Signal Board Scheme (ESP enterprise standard).

To obtain the Espressif production testing tool, please [contact us](#).

1.1. RF General-purpose Tester Scheme

The tester scheme is widely used for the production testing of Wi-Fi products. Espressif provides the necessary serial port commands and firmware, so the customers can easily use this scheme for testing.

The testing steps can be found below, which are also demonstrated in Figure 1-1:

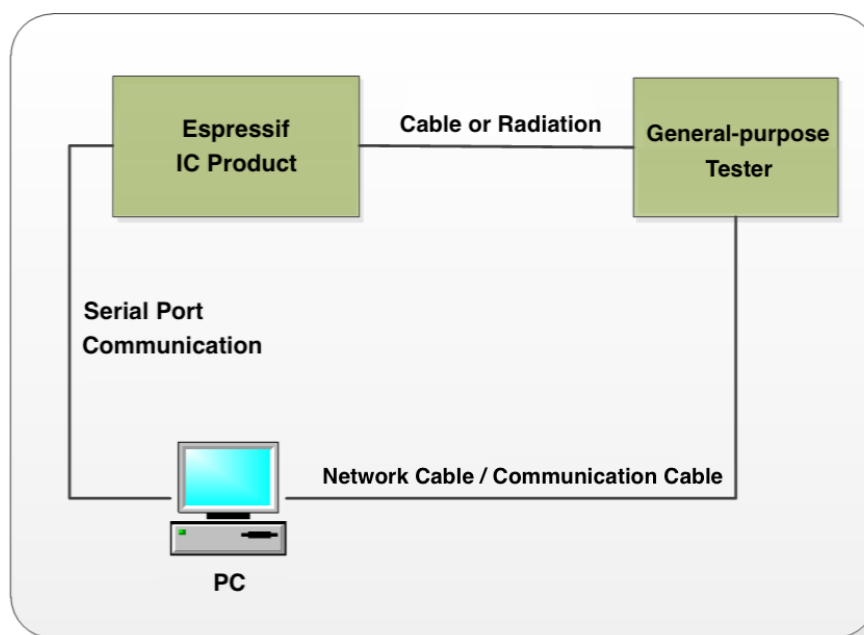

Figure 1-1. Diagram of the Tester Scheme

1. Download *RF_Test_FW.Bin* to ESP IC Ram;
2. Run the Test Tool that corresponds with the RF tester on the PC, and send the serial port commands to the modules for sending/receiving packets in different modes;
3. The RF tester analyzes the RF related parameters in each specific mode.

**Notes:**

- For this scheme, the mass production testing tool provided by the tester supplier should be adaptable with the Espressif IC products;
- If the supplier is unable to provide this kind of test tool, customers can alternatively make the tool adaptable by using the tester's available interfaces. Meanwhile, a **esp_ram_download_tool** is available for customers to download **RF_Test_FW.bin**:
 - To obtain the esp_ram_download_tool, please [contact us](#);
 - For the manual testing of ESP products' RF performance, please refer to: [ESP32&ESP8266 RF Performance Test Demonstration](#).

1.2. Signal Board Scheme

The signal board scheme is specially designed by Espressif, which can effectively test the RF performance of the mass-produced Wi-Fi products, and therefore guarantee the RF quality. This scheme features low cost of hardwares and easy environment setup for factories.

As demonstrated in the figure below, the signal board can be used as a standard device to interact with and test the DUT (Device Under Test) by analyzing the communication data.

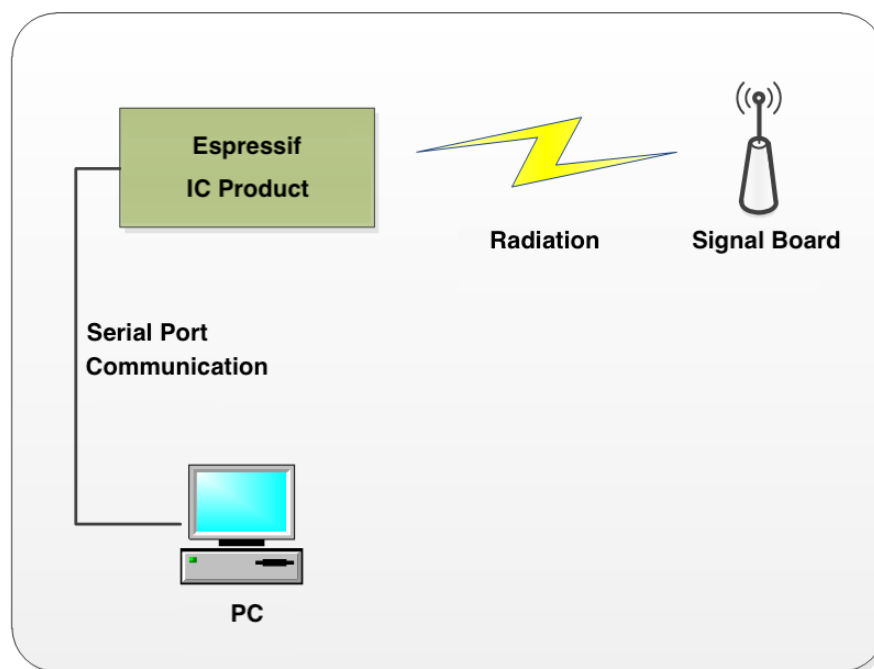

Figure 1-2. Diagram of Signal Board Scheme

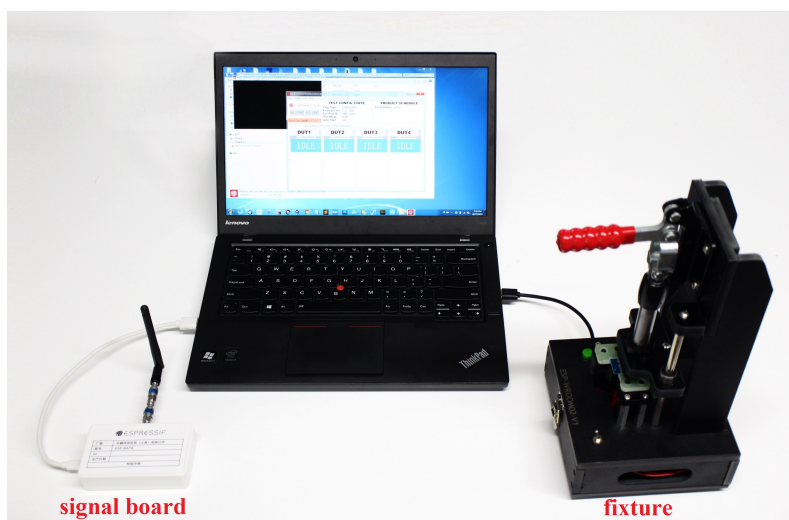

Figure 1-3. Hardware Connection for Signal Board Scheme

1.3. Production Testing Process

1. Please find the followings that need to be tested, and connect the DUT accordingly to conduct the test:
 - For ESP32: 3V3, EN, GND, U0TX, U0RX and GPIO0 (the pins assigned to them should be led out).
 - For ESP8266: 3V3, EN, GND, U0TX, U0RX, GPIO15 and GPIO0 (the pins assigned to them should be led out, and connect GPIO15 to GND).

Notes:

GPIO0 is mainly used to switch between the “download mode” and the “flash operation mode”:

- *Download mode: GPIO0 is connected to GND and pulled low (mainly for downloading the bin files). The entire production testing process works in this mode;*
- *Flash operation mode: GPIO0 is floating or pulled high.*

2. Connect the DUT to the serial port board by using the test fixture, and make sure the DUT enters the download mode (connect GPIO0 to GND):
 - Connect the cables coming out of the fixture probe to the serial port board, and make sure they are connected to the board's correct UART and power supply;
 - Connect GPIO0 to GND, EN to 3V3, GPIO15 to GND (only for ESP8266).
 - Connect the serial port board (which is placed inside the bottom box of the fixture) to the PC with a USB cable, and install the corresponding driver to ensure the serial port can be successfully identified.
3. Open the production testing tool on the PC. About how to use this tool, please refer to chapter 3.

**Notes:**

- To speed up the production efficiency, a test fixture is generally designed to be one-to-multiple, which means multiple serial port boards are used:
 - One typical design is one-to-four. With four serial port boards, four DUTs can be placed in one fixture and tested simultaneously.
- For more details about the test fixture manufacturing instruction, please refer to: https://www.espressif.com/sites/default/files/documentation/test_fixture_manufacturing_instruction_en.pdf

1.4. Related Equipments for Production Testing

1.4.1. Serial Port Board

The serial port board is mainly used as a USB converter. You may use other similar boards. However, considering some of them might have unstable performance, it is recommended to purchase what is shown below (if you want to purchase from Espressif, please [contact us](#)).

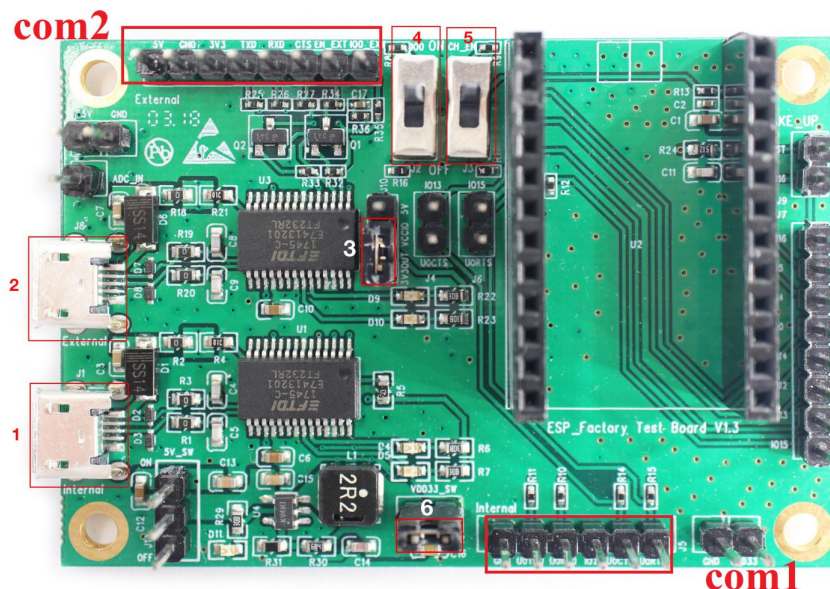

Figure 1-4. Serial Port Board

Please check the board you purchased against the following requirements to make sure the switches and shorting jumpers are in the correct positions:

- Marking com1 and Marking com2: the serial ports used for the communication with the PC. Marking 1 and Making 2 are the two independent serial ports, corresponding to TX/RX/RTS/CTS.
- Marking 3: it is mainly used to jump between com2 3.3 V level and 5 V level.
- Marking 6: it is used to enable 3.3 V, and shorting jumpers should be used here.
- Marking 4: not applicable, so no need to configure.



- Marking 5: not applicable, so no need to configure.

1.4.2. Test Fixture

The test fixture is an important equipment to execute the DUT in test mode. Specifically, you can put the module on the fixture and bring the module pins into contact with the fixture probes by pressing the fixture handle. When the test is finished, lift the handle to separate the module pins from the probes (for other similar equipments, customers may think of it as a reference or directly lead out the corresponding pins that are assigned to what you want to test).

For the production testing of Wi-Fi modules, the module pins must be led out and connected to the base board, so as to communicate with the serial ports of the PC. To achieve this, a fixture can be used. Figure 1-5 shows the overall appearance of a typical fixture.

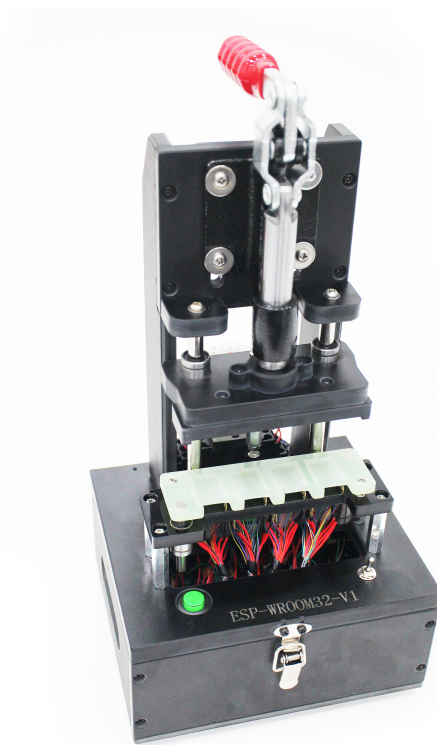

Figure 1-5. A Typical Module Fixture



The primary structure of a typical module fixture can be seen in Table 1-1 (take Espressif test fixture as an example).

Table 1-1. The primary structure of a typical module fixture

Part	Description
Handle	<ul style="list-style-type: none">• When users lift the handle, the module is separated from the metal probes at the bottom and gets disconnected from the power supply.• When users press the handle, the module comes into contact with the metal probes and starts the testing procedure.
Mounting Panel	It is used for placing and holding the module.
Bottom box	It is used to place serial port testing board(s), enabling the module to communicate with the PC via USB.
Switch	It is installed on the bottom box to control the power supply to the serial port board and the working modes.

1.4.3. Signal Board

The signal board can be used a standard device to interact with the DUT during the production testing.

For the purchase of Espressif signal board, please [contact us](#).

⚠ Notice:

- *The signal boards for ESP32 and ESP8266 are different, and they shouldn't be mixed up;*
- *Only one signal board should be used within the same network coverage. Otherwise, signal interference will occur;*
- *If more than one signal board are used for mass testing, please conduct in a shielded room or with a shielded box.*



Figure 1-6. A Typical ESP8266 Signal Board



Figure 1-7. A Typical ESP32 Signal Board

1.5. Scheme Comparison

The comparison between the signal board scheme and the tester scheme is shown in table 1-2. You can choose from these two schemes according to your actual requirements.



Table 1-2. Scheme Comparison

Scheme	Test Item	Description
Signal Board Scheme	RF Test	Tests the supply voltage of the chip and its fluctuation, and the frequency offset against the signal board, etc.
	Packet Sending/Receiving Test	Tests the packet sending/receiving between the DUT and the signal board.
	GPIO Conductivity Test	Identifies IC soldering defects, if there are any.
	Firmware Version Verification Test	Verifies the version information of the firmware that has been downloaded to flash.
	Flash RW Test	Verifies the RW operation of flash.
Tester Scheme	EVM Test	Tests the TX Power, and EVM performance of the DUT during the packet sending.
	Frequency Offset Test	Tests the frequency of the DUT during the packet sending.
	TX Power Test	Tests the TX power of the DUT during the packet sending.
	RX Sensitivity Test	Tests RX sensitivity of the DUT (This test must be performed in an RF shielded environment).
	GPIO Conductivity Test	See above in this table.
	Flash RW Test	See above in this table.

Notes:

1. The signal board scheme has applied Espressif's internal standards and can effectively ensure the quality of RF products, provided that the RF matching of the module is qualified and the production materials are consistent with those specified in the production processes.
2. To ensure the overall quality of the mass production of modules, the customers may use the signal board scheme for full inspection and the tester scheme for sampling inspection.
3. You cannot directly test the RF performance parameters of a DUT, such as TX, RX, EVM, and FREQ, with the signal board scheme. Therefore, a general-purpose Wi-Fi tester can be used as a supplement to the signal board scheme.

The signal board scheme features low cost and easy environment setup, making it a popular solution that has long been widely used by the customers. Therefore, this guide will mainly focus on this scheme, and demonstrate it with the use of Espressif modules. Customers may follow this guide to set up the testing environment for their own Wi-Fi products.



2. Environment Setup

In order to show the customers the effectiveness of our signal board scheme, Espressif provides a complete testing package. Our testing package introduces the customers to the overall process of the production testing. Note that an Espressif module is used in the package as an example, so that the customers can simply replace this module with their Wi-Fi products (of ESP32/ESP8266 family) in their own production testing.

2.1. Testing Package

The production testing package has the following key components:

Table 2-1. Production Testing Package

Production Testing Package	Component	Quantity	Remark
ESP32	ESP-BAT32	1	ESP32 signal board
	ESP-FactoryTB1	2	UART base board
	ESP32-WROOM-32D	2	Espressif module
ESP8266	ESP-BAT8	1	ESP8266 signal board
	ESP-FactoryTB1	2	UART base board
	ESP-WROOM-02D	2	Espressif module

2.2. Test Step

Please connect your DUT to the production testing base board as shown in Figure 2-1 or Figure 2-2, depending on the product family (ESP32/ESP8266) your DUT belongs to; then, connect the serial port board, signal board and your PC together as specified in Figure 2-3; then, open the production testing software tool on your PC.

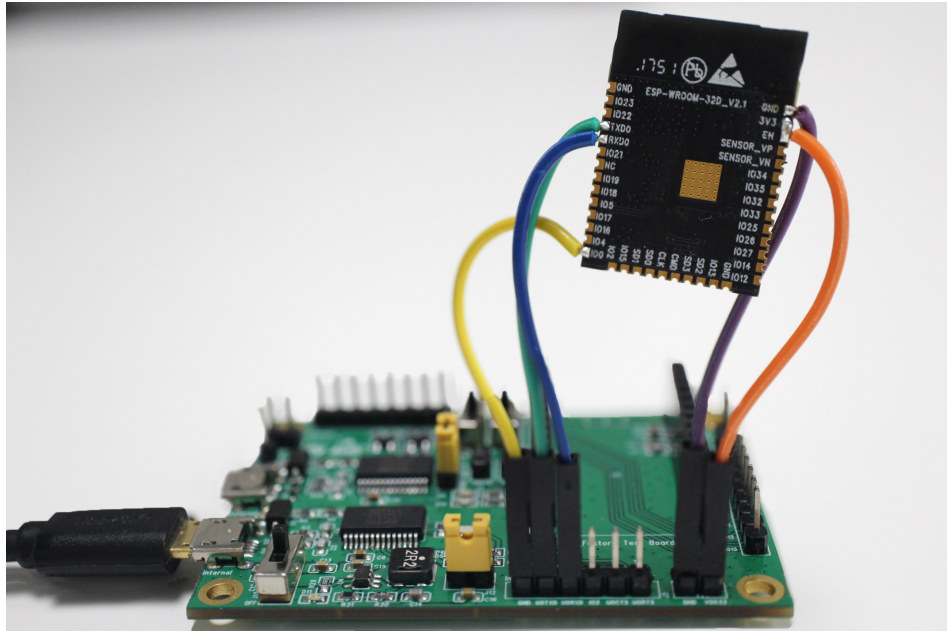

Figure 2-1. Wiring for ESP32-WROOM-32D in Download Mode

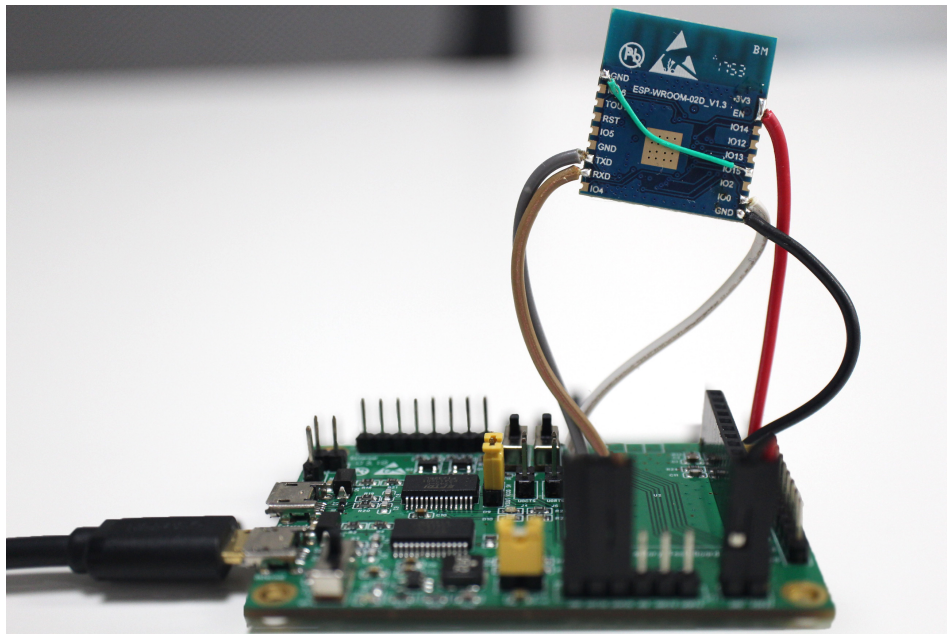

Figure 2-2. Wiring for ESP-WROOM-02D in Download Mode



1. The DUT communicates with the signal board at a rate of around 1 to 2 M. Configure the DUT to download mode and power up the serial port board.



Figure 2-3. Quick Start on Testing Diagram

2. Open the production testing software tool and complete the corresponding configuration based on which product family your DUT belongs to. For details, please refer to Section “Tool Configuration” below.
3. Click the **START** button to start the test. During the testing, Parameter **fb_rssi** in the Log must be kept at around 50 (for the DUT of ESP8266 family) or -50 (for the DUT of ESP32 family).
4. Troubleshoot based on the test results. For details, see Chapter “FAQ” below.



3. Production Testing Tool

3.1. Tool Introduction

3.1.1. Directory

- factory_test_tool: the main directory
 - factory_test_tool.exe: the executable file
 - bin: stores bin files
 - config: the configuration files run by the tool
 - configure: the temporary directory generated automatically when the tool is running
 - doc: stores documentation files
 - icon: stores screenshots of the tool
 - mac_list: the MAC list stored locally during the testing
 - threshold: stores threshold files
- Logs: the directory to store logs

3.1.2. Interface

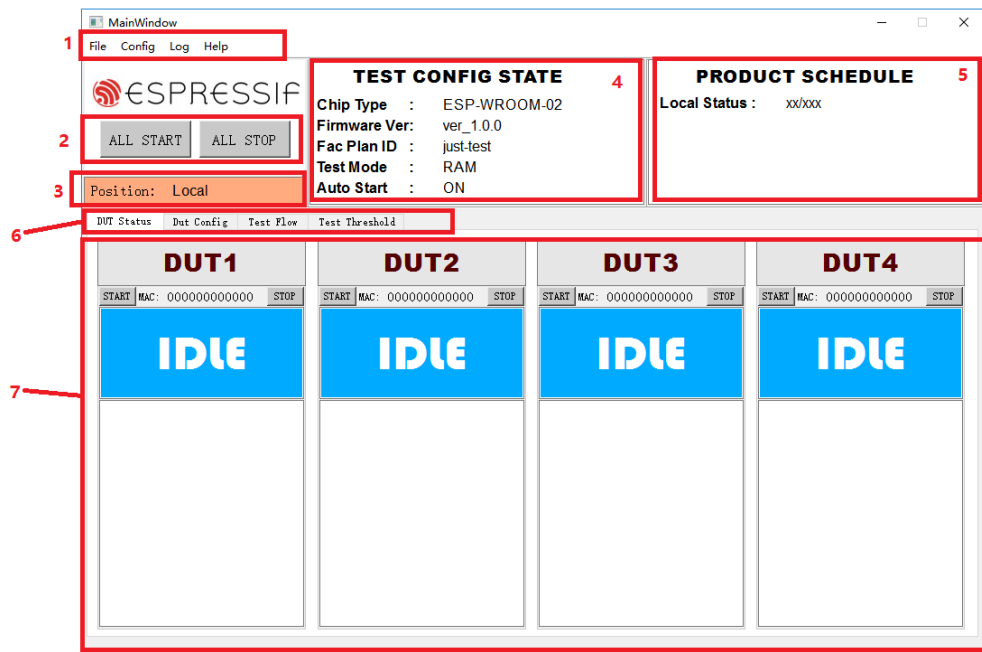

Figure 3-1. Main Interface

The MainWindows of the tool, as shown in Figure 3-1, can be divided into seven main parts:



1. **Menu Bar:** The **Config** button can be used to switch between Local Mode and Cloud Mode (Cloud Mode is currently not supported); the **Log** button can be used to select and open log files; the **Help** button can be used to find help files.
2. **ALL START/ALL STOP:** Start/Stop all operations.
3. **Position:** Displays if Local Mode or Cloud Mode is enabled.
4. **TEST CONFIG STATE:** Displays configuration information, such as the product type.
5. **PRODUCT SCHEDULE:** Displays the statistics of all test results, currently only locally (the number of pass/failed cases).
6. **Interface Tab Bar:** Switches between different interfaces for testing or configuration.
7. **Testing Interface:** Default testing interface after configuration. Here, you can see four DUT blocks, because a one-to-four fixture is used. Testing for different DUTs is independent from each other while the configuration of those is not.

3.1.3. Test Mode

The current testing tool supports two types of testing:

- **RAM Test** (ESP32 and ESP8266)
 - Before testing, make sure the DUT is in download mode. During testing, the host computer downloads the firmware for testing to the RAM of the DUT, and runs it.
- **Flash Jump Test** (ESP8266 Only)
 - Before testing, make sure the DUT is in operation mode. During testing, the application firmware or the testing firmware is run, depending on the setting of jump rules. For details, please refer to “Appendix” below.



3.2. Tool Configuration

3.2.1. Interface

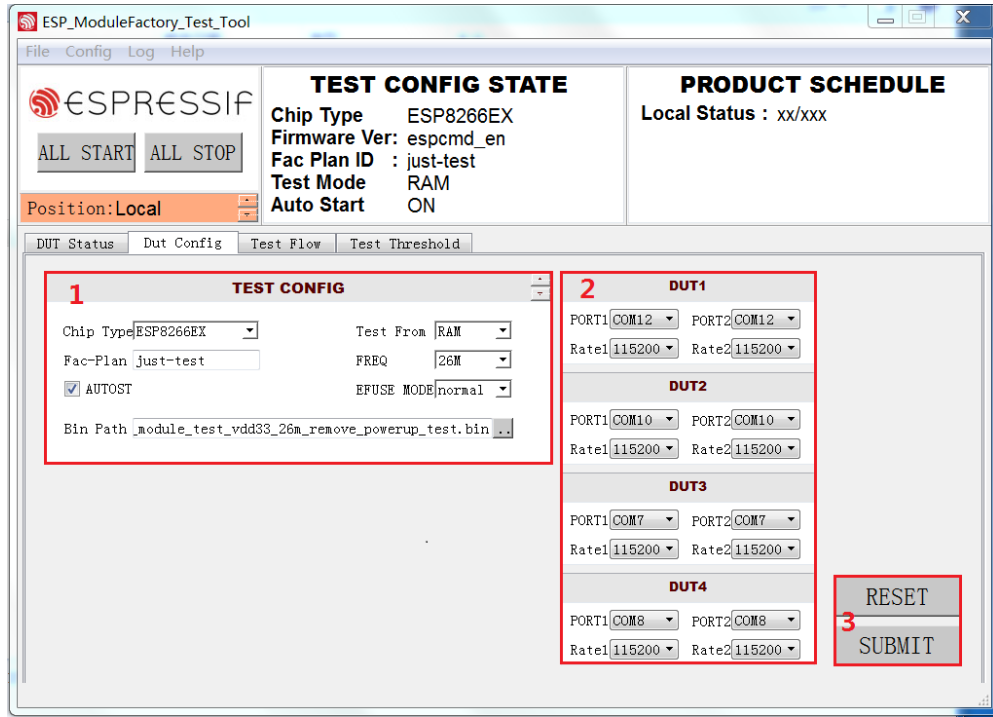

Figure 3-2. DUT Config

As shown in Figure 3-2, the *Dut Config* tab can be divided into three major blocks:

1. **TEST CONFIG**: Test-related configuration
2. **DUT**: DUT-related configuration
3. **RESET/SUMBIT**

3.2.2. TEST CONFIG

Table 3-1. TEST CONFIG

Parameter	Description	Notes
Chip Type	Product family to which the DUT belongs	<ul style="list-style-type: none"> ESP8266EX ESP32
Test From	Location from which the program starts to run	<ul style="list-style-type: none"> Flash: The test bin for jump test must be downloaded to flash before the test starts; RAM: The test bin to be downloaded must be selected.
Fac-Plan	Test record code	The MAC list stored in the form of “code + test result”.
FREQ	Crystal oscillator frequency of the DUT	Typically, 26 M and 40 M are supported.
AUTOST	Automatic test switch	If this option is checked, a new test will start automatically when the current test finishes.



Parameter	Description	Notes
EFUSE MODE	Detection method of eFuse	If a customized MAC address is used, the “custom” option should be selected here. Otherwise, use “normal”.
Bin Path	Testing bin	Optional for RAM test only.

3.2.3. DUT CONFIG

Table 3-2. DUT CONFIG

Parameter	Description	Note
Port	Serial port number	Serial port configuration of the DUT, including the serial port for normal test and the serial port for firmware test. The configuration of these two serial ports can be the same or not, depending on the customers' actual requirements.
Rate	Baud rate	Baud rate of the serial port.
RESET	Order Number	Restores the settings of the interface, based on the current configuration file.
APPLY	Confirms all the modification that has been made	Any modification to the configuration on the interface takes effect only after clicking the APPLY button and passing the verification by entering the correct verification code. The verification code depends on the date and time of performing the test (the sum of the values of year, month, day and hour). For example, assuming the test is performed at 12 o'clock on March 1st, 2018, the verification code is the sum of 2018 (year), 03 (month), 01 (date) and 15 (hour), i.e. 2037.

3.3. Test Flow

In addition to some basic RF performance tests, the production testing scheme can also be used to evaluate the overall quality of the DUT through a variety of other tests, including but not limited to the RF Test (customizing commands is allowed), GPIO Conductivity Test, Firmware Version Verification Test, and Flash RW Test.

3.3.1. RF Test

- **Test Objective:** RF performance tests must be conducted during the production testing to ensure that the DUT can send/receive packets as expected.
- **Test Method:** Send/Receive packets back and forth between the signal board and the DUT through radiation. The DUT sends the test results to the host computer via the serial port. Then, the host computer provides conclusions by analyzing the test results.
- **Test Steps:** DUT runs with the testing firmware. The test starts after the host computer sends the serial port commands. Initially, the DUT obtains the RF performance information by reading registers, including the voltage fluctuations; then the DUT sends/receives a certain number of packets to/from the signal board; upon completion, the host computer determines if the DUT has passed the tests by checking the log information against the set thresholds.
- **Configuration Interface:** To enable this test, go to the **Test Flow** tab and check **RF_TEST**.



Figure 3-3. RF Test

3.3.2. GPIO Conductivity Test

- **Test Objective:** This test can be performed to check the conductivity of GPIOs. It can help identify if there are any soldering problems, such as insufficient wetting or solder bridges.
- **Test Method:** After the corresponding pins of the fixture and DUT are shortened, the pin levels are set and obtained with the serial port commands, thus identifying any existing soldering problems.
- **Test Steps:** After the RF test is completed, a series of serial port commands are sent to perform the GPIO conductivity test. The serial port commands have been integrated in the host computer, so the customers can easily perform the GPIO Conductivity Test by enabling this function.
- **Configuration Interface:** As shown in Figure 3-4, you can enable this test in the *GENERAL_TEST* sub-list on the *Test Flow* tab. For details, please refer to Appendix B.

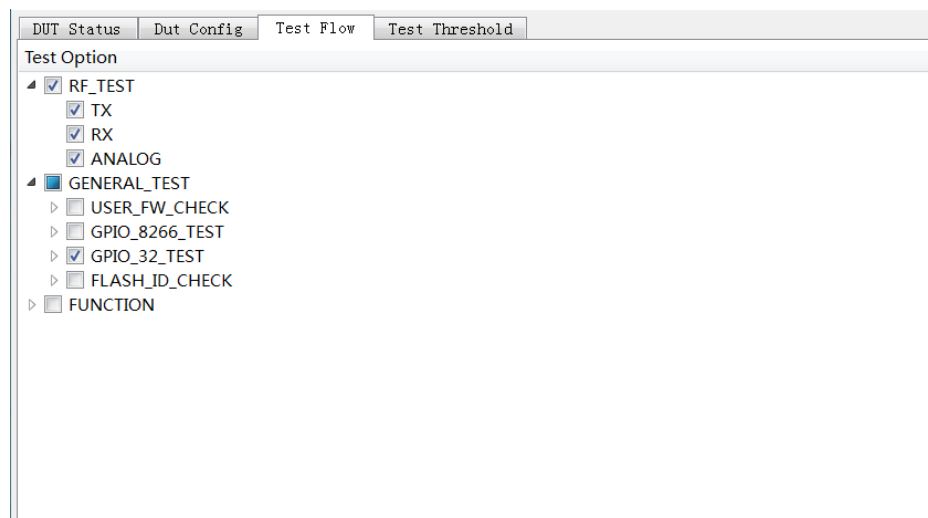

Figure 3-4. ESP32 GPIO Conductivity Test

3.3.3. Firmware Version Verification Test

- **Test Objective:** This test can be performed to verify the correctness of the firmware version downloaded to flash.



- **Test Method:** Check against the target firmware by comparing a “certain verification string” or “version number” in the serial port log. Therefore, this verification string must distinguish itself from those of other firmware.
- **Test Steps:** After the RF test, the host computer configures the serial port board to flow control mode, so the DUT boots from flash, and check the string in the log against the target string. You can easily verify the firmware version by enabling this function.
- **Configuration Interface:** You can enable this test in the **GENERAL_TEST** sub-list on the **Test Flow** tab. For details, please refer to Appendix C.



Figure 3-5. Firmware Version Verification Test

3.3.4. Flash-related Test

- **Test Objective:** Flash ID Verification Test and Flash RW Test can be performed to verify the correctness of the flash model and the ability of the flash to read/write respectively.
- **Test Method:** These tests are performed with serial port commands, and the test results are returned to the host computer via the serial port.
- **Test Steps:** After the RF test is completed, the host computer provides a conclusion by checking the test results.
- **Configuration Interface:** You can enable these tests in the **GENERAL_TEST** sub-list on the **Test Flow** tab.



Figure 3-6. Flash-related Test



3.4. Tool Operation

Two different test modes are supported in the signal board scheme: the Single-DUT mode and the Four-DUT mode. The configuration below is applicable to both of these two test modes. The operation process is as follows:

1. After setting up the environment, click the **Start** button (or **ALL START**) to begin synchronization and downloading.

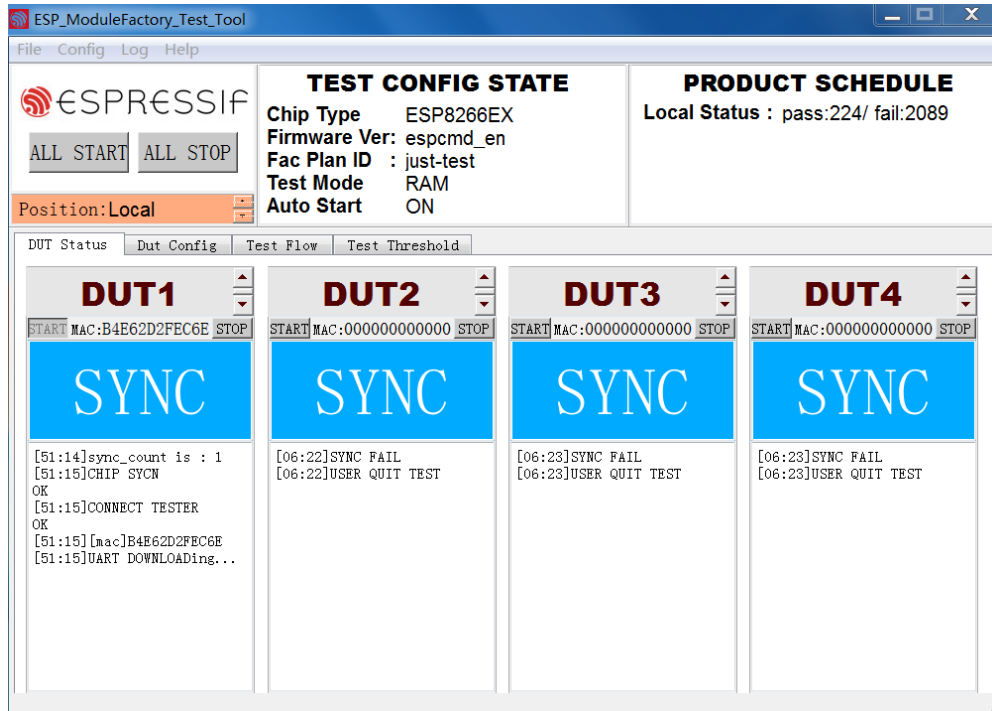

Figure 3-7. Synchronization

2. After downloading is finished, the tool displays testing progress (**RUN**). Wait for test results.

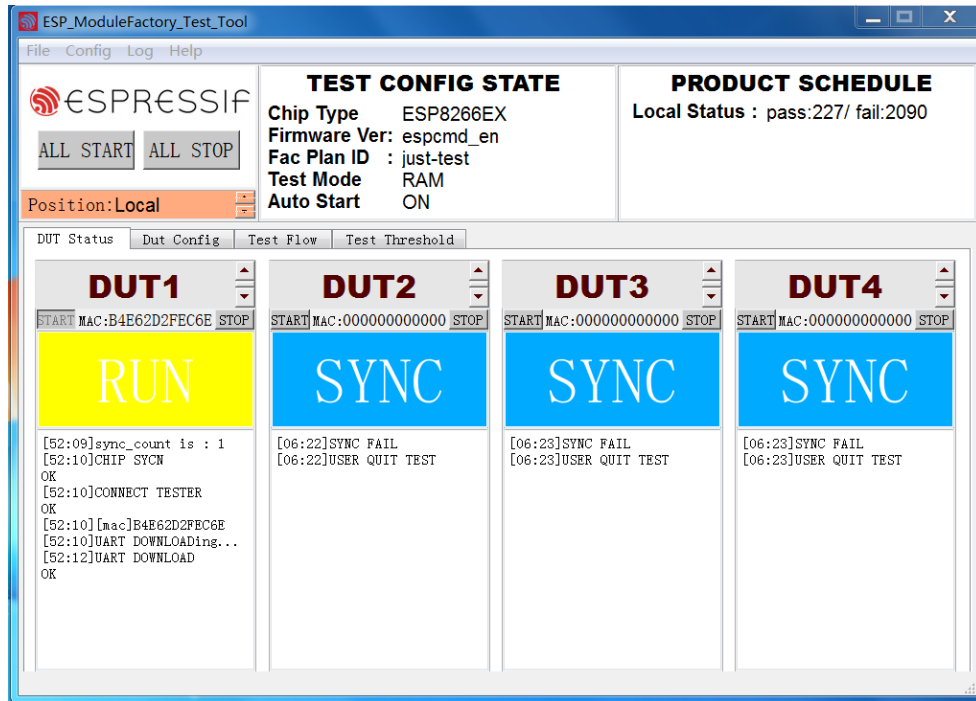

Figure 3-8. Running

3. The tool displays test results.

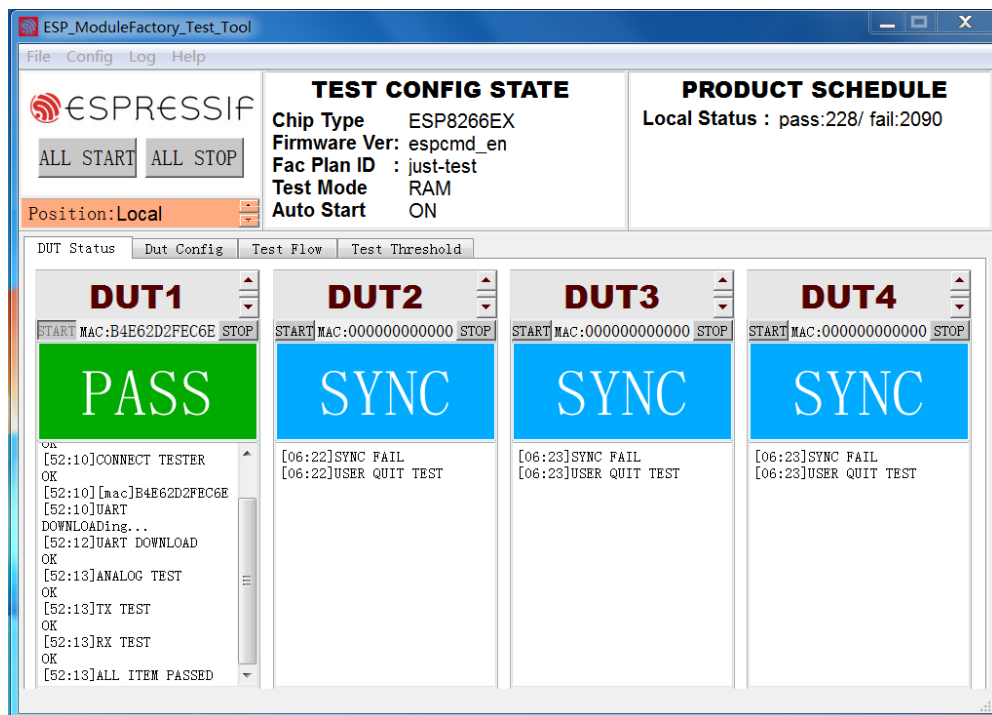

Figure 3-9. Finish

The tool displays **FAIL** if any test item fails. The status block lists the detailed results of each test, to help you identify the reasons.

4. Check the detailed test records.

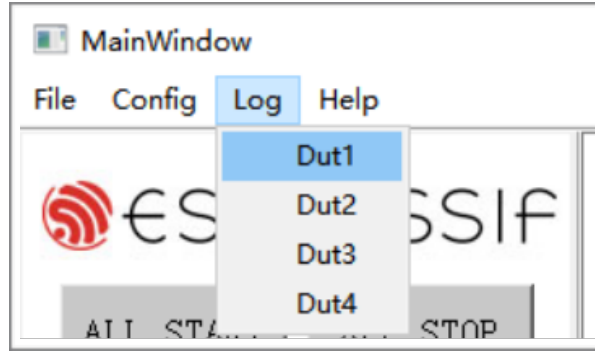

Figure 3-10. Check Test Record

The test results of each production test will be saved in a separated log. The name of each log follows the pattern of "DUT MAC + date". Click the **Log** button to bring up the log file of the last test for the corresponding DUT. If there is no test history for this workstation, open the **Logs** folder to access available logs.



A. Appendix – FAQ

A.1. Why it is necessary to set up an evaluating environment?

An evaluating environment should be set up before the actual production testing, so as to check:

- if the power supplies of the DUT and signal board are stable.
- if the signal board currently being used meets the requirements.
- if the base board currently being used meets the requirements.
- if the ambient environment is free from interferences.

A.2. Why the signal received by my DUT is excessively strong?

Question:

After the testing was completed, I saw an error message of ***RX FAIL***. Checking the testing log, I found that the parameters ***fb_rssi*** and ***dut_rssi*** were around 60 and -30 respectively.

Solution:

- Please move the signal board AWAY from the DUT;
- Or add a 30 dB attenuator at the signal board.

A.3. Working life and range of signal Board

The MAC address and production date of the board are given at the back of the signal board. Note that the signal board must be recalibrated every year, because the long operating time of components, such as crystal oscillators, may lead to measurement deviations. Only ONE signal board must be used in an independent environment or RF-shielded environment to avoid interference.



B. Appendix – GPIO Conductivity Test Configuration

The pins to be tested should be connected with each other as instructed below. One pin works as an output for a signal, while the other one works as an input and reads the current signal. The reading may not be considered as the default INPUT. For this, the reading at the OUTPUT should be inverted. Repeat the test one more time. If both of these two tests pass, the GPIO conductivity test can be considered successful. The detailed configurations for ESP32 and ESP8266 products are described below.

B.1. GPIO Conductivity Test Configuration for ESP32

Please see the followings to configure the GPIO conductivity test for ESP32-WROOM-32D module.

Pin wiring:

- IO23-->IO34
- IO22-->IO35
- IO15-->IO32
- IO02-->IO33
- IO19-->IO25
- IO18-->IO26
- IO05-->IO12
- IO13-->IO27
- IO21-->IO14

Configuration on the host computer:

- ▾ GPIO_32_TEST
 - ▾ GPIO_32_TEST_VAL_0
0xD9000C20
 - ▾ GPIO_32_TEST_VAL_1
0x0054ece0
 - ▾ GPIO_32_TEST_VAL_2
0x00000055
 - ▾ GPIO_32_TEST_TARGET_0
0x33000000
 - ▾ GPIO_32_TEST_TARGET_1
0x00AC0000
 - ▾ GPIO_32_TEST_TARGET_2
0x000000BB



Serial port command: *ESP_TEST_GPIO* <Parameter1> <Parameter2> <Parameter3>

- **Command Description:** The states of a GPIO are represented with a 2-bit character. Each GPIO has four states:
 - 00: the default mode;
 - 01: INPUT;
 - 10: the OUTPUT level is low;
 - 11: the OUTPUT level is high.
- **Parameter description:**
 - <Parameter1>: 32-bit character, which represents the states of the range from GPIO0 to GPIO15. To be more specific, bit [1:0] represents the states of GPIO0, bit [3:2] represents the states of GPIO1,... bit [30:31] represents the states of GPIO15.
 - <Parameter2>: 32-bit character, which represents the states of the range from GPIO16 to GPIO31. To be more specific, bit [1:0] represents the states of GPIO16, bit [3:2] represents the states of GPIO17,... bit [30:31] represents the states of GPIO31.
 - <Parameter3>: 32-bit character, which represents the states of the range from GPIO32 to GPIO47. To be more specific, bit [1:0] represents the states of GPIO32, bit [3:2] represents the states of GPIO33,... bit [30:31] represents the states of GPIO47.
- **Result:**
 - **Input result:** <Parameter1> <Parameter2> <Parameter3>
 - **Description:** A 2-bit character is used to represent a GPIO as input result, in which the higher bit indicates whether the input is valid, while the lower bit represents the input level. Each GPIO as INPUT has four results in total:
 - ▶ 00: this GPIO does not work as INPUT;
 - ▶ 10: the OUTPUT level is low;
 - ▶ 11: the INPUT level is high;
 - ▶ 01: no significant meaning.
 - **Parameter description:**
 - ▶ <Parameter1>: 32-bit character, which represents the input results of the range from GPIO0 to GPIO15. To be more specific, bit [1:0] represents the input results of GPIO0, bit [3:2] represents the input results of GPIO17,... bit [30:31] represents the input results of GPIO15.
 - ▶ <Parameter2>: 32-bit character, which represents the input results of the range from GPIO16 to GPIO31. To be more specific, bit [1:0] represents the input



results of GPIO16, bit [3:2] represents the input results of GPIO17,... bit [30:31] represents the input results of GPIO31.

- ▶ **<Parameter3>**: 32-bit character, which represents the input results of the range from GPIO32 to GPIO47. To be more specific, bit [1:0] represents the input results of GPIO32, bit [3:2] represents the input results of GPIO33,... bit [30:31] represents the input results of GPIO47.

⚠ Notice:

ESP32 has 34 GPIOs, of which:

- GPIO20, GPIO24, and GPIO28 to GPIO31 are not available for state configuration;
- GPIO1/U0RXD and GPIO3/U0TXD are used to send/receive commands, thus cannot be used for IO tests (Therefore, the test results are considered invalid);
- GPIO34 to GPIO39 only work as INPUT only.

B.2. GPIO Conductivity Test Configuration for ESP8266

Please see the followings to configure the GPIO conductivity test for ESP-WROOM-02D module.

Pin wiring:

- IO2 --> IO14
- IO4 --> IO13
- IO5 --> IO12

Configuration on the host computer:

```
└─  GPIO_8266_TEST
  └─ GPIO_8266_TEST_PIN
      0x3030
  └─ GPIO_8266_TEST_VAL
      0x1010
  └─ GPIO_8266_TEST_VAL_TARGET
      0x1010
```

Serial port command: `gpio_test <Parameter1> <Parameter2> <Parameter3>`

- **Parameter description:**

- **<Parameter1>**: enables the GPIO pin test, including input pins and output pins. A 16-bit character, which represents the enable bit of IO0 to IO15. To be more specific, the lowest bit represents IO0, the second lowest bit represents IO1,...and the highest bit represents IO15. "1" indicates ENABLE, which means this IO is available for GPIO test. "0" indicates DISABLE, which means this IO is not available for GPIO test.



- **<Parameter2>**: The OUTPUT of a certain GPIO. “1” indicates the OUTPUT of this GPIO has high level, and “0” has low level. For example, 0x1000 represents that GPIO12 output has high level.
- **<Parameter3>**: The enable switch of GPIO output. If <Parameter1> of one pin is enabled and the <Parameter3> is set to “1”, this pin works as an OUTPUT pin. If <Parameter1> of one pin is enabled and the <Parameter3> is set to “0”, this pin works as an INPUT pin.

Serial port command: *gpio_read*

Command description: read the values of all pins that enable the GPIO test.



C. Appendix – Firmware Version Verification Test

The detailed configuration of the firmware version verification test is shown below:

```
┆  USER_FW_CHECK
┆   ┆ USER_FW_VER_TEST
┆     ┆ USER_FW_VER_STR
┆       0.17.59eh
┆     ┆ USER_FW_VER_TIMEOUT(s)
┆       3
┆     ┆ USER_FW_VER_DELAY(s)
┆       0
┆   ┆ USER_TEST_CMD<cmd,rsp,tmo>
┆     <AT+GMR,"0.10.0",5>
```

The firmware version verification test is enabled if the option **USER_FW_CHECK** is checked. Here, two test modes are available:

- **USER_FW_VER_TEST**: If the **USER_FW_VER_STR** is set to “*Espcmd_en*”, the **USER_TEST_CMD** is enabled. Otherwise, **USER_FW_VER_TEST** is enabled, in which a string is used to verify the firmware version number, such as the “0.17.59eh” in the figure above.
- **USER_TEST_CMD**: If the **USER_FW_VER_STR** is set to “*Espcmd_en*”, the **USER_TEST_CMD** is enabled. You can verify the firmware version number with your customized commands. For example, the value **<AT+GMR,“0.10.0”,5>** in the figure above indicates that after sending the command **AT+GMR**, the serial port should return a character string that contains “0.10.0”.



D. Appendix – Jump Test Configuration

Test Objective: The production testing firmware can be downloaded to flash in advance, together with the application firmware, which saves the time to download the test firmware online and improves the production efficiency.

Test Step: After the system is powered on, the bootloader determines whether to enter the jump test by checking the flag bit of *esp_init_data.bin* in the flash. When the jump test is enabled, the system loads the *esp_fac_test_cfg.bin*, and runs with the production testing firmware.

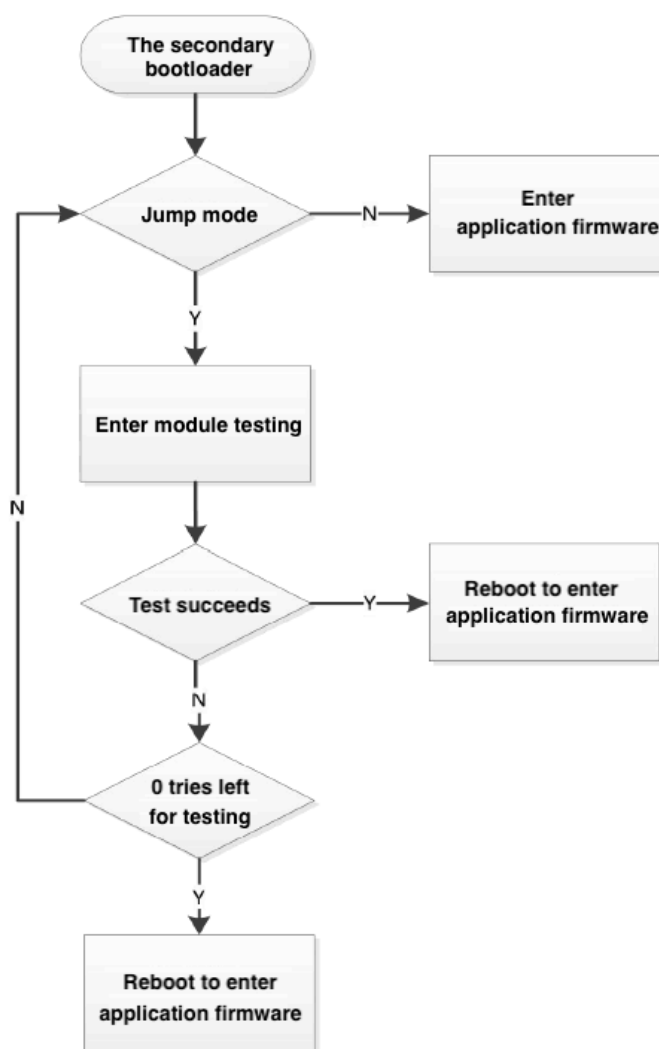



Test Configuration:

- **boot.bin**: The secondary bootloader of the chip provided in SDK (The version of this SDK should support the jump test).
- **user.bin**: The application files developed by customers.
- **esp_init_data_default.bin**: The RF parameter file generated by tools. Users can enable the jump test by modifying the flag bit of this file.
- **esp_fac_test_cfg.bin**: The configuration file for the parameters of the jump test generated by tools. The address is configurable. This file specifies information, such as the number of jumps, the address that stores the testing firmware, and the test results of the DUT.
- **ESP8266_MOD_TEST_V118_2nd_JUMP_BIN_V1_26M_20180202.bin**: The testing firmware with configurable address. The testing firmware provided by Espressif should be used here.

To facilitate the customer's jump test, Espressif has provided a [tool](#) to generate bin files, as follows:

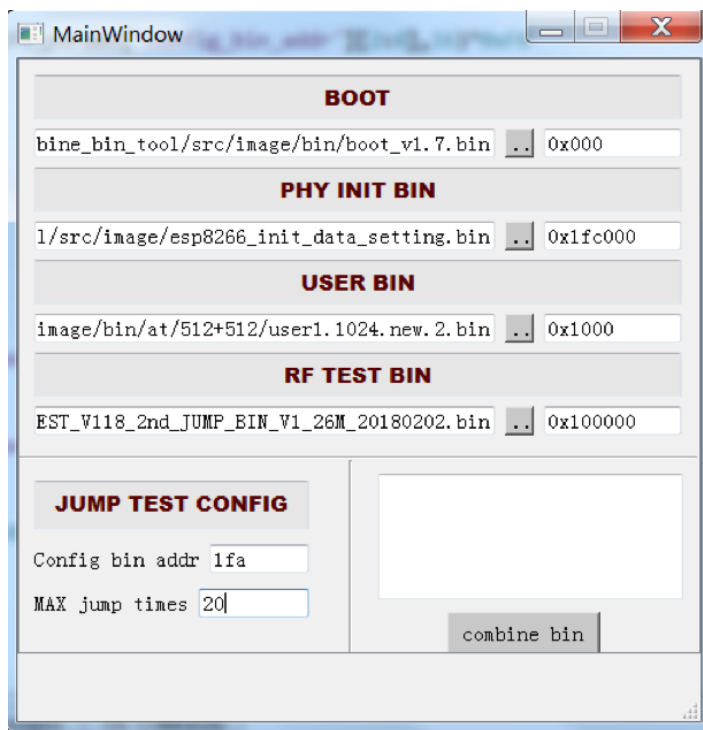

You only need to configure the downloading address of your bin files, the address that stores the configuration files (For example, 1FA indicates 0x1fa000), and the maximum number of jump. Click **Combine Bin** to generate bin files. Then, use the **Flash Download Tool** to download the firmware to the DUT.



Espressif IoT Team
www.espressif.com

Disclaimer and Copyright Notice

Information in this document, including URL references, is subject to change without notice.

THIS DOCUMENT IS PROVIDED AS IS WITH NO WARRANTIES WHATSOEVER, INCLUDING ANY WARRANTY OF MERCHANTABILITY, NON-INFRINGEMENT, FITNESS FOR ANY PARTICULAR PURPOSE, OR ANY WARRANTY OTHERWISE ARISING OUT OF ANY PROPOSAL, SPECIFICATION OR SAMPLE.

All liability, including liability for infringement of any proprietary rights, relating to use of information in this document is disclaimed. No licenses express or implied, by estoppel or otherwise, to any intellectual property rights are granted herein.

The Wi-Fi Alliance Member logo is a trademark of the Wi-Fi Alliance. The Bluetooth logo is a registered trademark of Bluetooth SIG.

All trade names, trademarks and registered trademarks mentioned in this document are property of their respective owners, and are hereby acknowledged.

Copyright © 2018 Espressif Inc. All rights reserved.

Данный компонент на территории Российской Федерации

Вы можете приобрести в компании MosChip.

Для оперативного оформления запроса Вам необходимо перейти по данной ссылке:

<http://moschip.ru/get-element>

Вы можете разместить у нас заказ для любого Вашего проекта, будь то серийное производство или разработка единичного прибора.

В нашем ассортименте представлены ведущие мировые производители активных и пассивных электронных компонентов.

Нашей специализацией является поставка электронной компонентной базы двойного назначения, продукции таких производителей как XILINX, Intel (ex.ALTERA), Vicor, Microchip, Texas Instruments, Analog Devices, Mini-Circuits, Amphenol, Glenair.

Сотрудничество с глобальными дистрибьюторами электронных компонентов, предоставляет возможность заказывать и получать с международных складов практически любой перечень компонентов в оптимальные для Вас сроки.

На всех этапах разработки и производства наши партнеры могут получить квалифицированную поддержку опытных инженеров.

Система менеджмента качества компании отвечает требованиям в соответствии с ГОСТ Р ИСО 9001, ГОСТ РВ 0015-002 и ЭС РД 009

Офис по работе с юридическими лицами:

105318, г.Москва, ул.Щербаковская д.3, офис 1107, 1118, ДЦ «Щербаковский»

Телефон: +7 495 668-12-70 (многоканальный)

Факс: +7 495 668-12-70 (доб.304)

E-mail: info@moschip.ru

Skype отдела продаж:

moschip.ru

moschip.ru_4

moschip.ru_6

moschip.ru_9