



Features

- 85MHz to 2700MHz LO Frequency Range
- Fractional-N Synthesizer with Very Low Spurious Levels
- Typical Step Size 1.5Hz
- Fully Integrated Low Phase Noise VCO and LO Buffers
- Integrated Phase Noise 0.18° rms at 1GHz
- High Linearity RF Mixer(s)
- 30MHz to 2700MHz Mixer Frequency Range
- Input IP3 +23dBm
- Mixer Bias Adjustable for Low Power Operation
- Full Duplex Mode (RFMC2071)
- 2.7V to 3.3V Power Supply
- Low Current Consumption
- 3- or 4-Wire Serial Interface

Applications

- CATV Head-Ends
- Digital TV Repeaters
- Multi-Dwelling Units
- Diversity Receivers
- Software Defined Radios
- Frequency Band Shifters
- Point-to-Point Radios
- Cellular Repeaters
- WiMax/LTE Infrastructure
- Cellular Jammers
- Satellite Communications
- VHF/UHF Radios

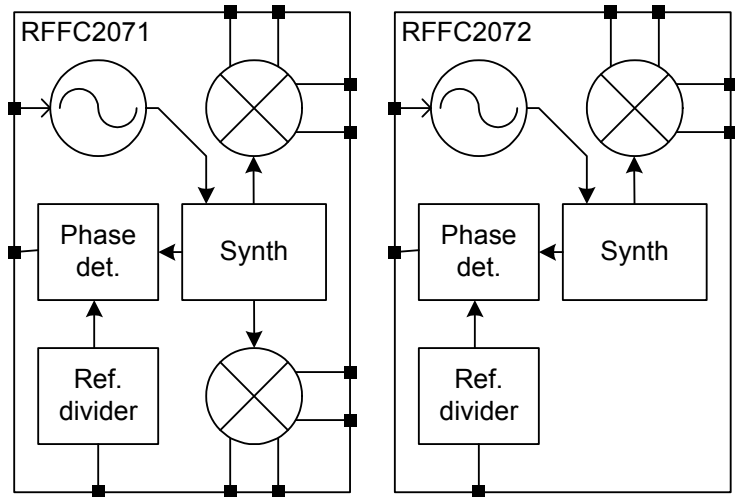

Functional Block Diagram

Product Description

The RFMC2071 and RFMC2072 are re-configurable frequency conversion devices with integrated fractional-N phased locked loop (PLL) synthesizer, voltage controlled oscillator (VCO) and either one or two high linearity mixers. The fractional-N synthesizer takes advantage of an advanced sigma-delta modulator that delivers ultra-fine step sizes and low spurious products. The PLL/VCO engine combined with an external loop filter allows the user to generate local oscillator (LO) signals from 85MHz to 2700MHz. The LO signal is buffered and routed to the integrated RF mixers which are used to up/down-convert frequencies ranging from 30MHz to 2700MHz. The mixer bias current is programmable and can be reduced for applications requiring lower power consumption. Both devices can be configured to work as signal sources by bypassing the integrated mixers. Device programming is achieved via a simple 3-wire serial interface. In addition, a unique programming mode allows up to four devices to be controlled from a common serial bus. This eliminates the need for separate chip-select control lines between each device and the host controller. Up to six general purpose outputs are provided, which can be used to access internal signals (the LOCK signal, for example) or to control front end components. Both devices operate with a 2.7V to 3.3V power supply.

Optimum Technology Matching® Applied

- | | | | |
|--------------------------------------|--------------------------------------|---|------------------------------------|
| <input type="checkbox"/> GaAs HBT | <input type="checkbox"/> SiGe BiCMOS | <input type="checkbox"/> GaAs pHEMT | <input type="checkbox"/> GaN HEMT |
| <input type="checkbox"/> GaAs MESFET | <input type="checkbox"/> Si BiCMOS | <input checked="" type="checkbox"/> Si CMOS | <input type="checkbox"/> BIFET HBT |
| <input type="checkbox"/> InGaP HBT | <input type="checkbox"/> SiGe HBT | <input type="checkbox"/> Si BJT | <input type="checkbox"/> LDMOS |

Absolute Maximum Ratings

| Parameter | Rating | Unit |
|------------------------------------|------------------------|------|
| Supply Voltage (V_{DD}) | -0.5 to +3.6 | V |
| Input Voltage (V_{IN}) any pin | -0.3 to $V_{DD} + 0.3$ | V |
| RF/IF mixer input power | +15 | dBm |
| Operating Temperature Range | -40 to +85 | °C |
| Thermal Resistance (R_{TH}) | 32 | °C/W |
| Storage Temperature Range | -65 to +150 | °C |



Caution! ESD sensitive device.

Exceeding any one or a combination of the Absolute Maximum Rating conditions may cause permanent damage to the device. Extended application of Absolute Maximum Rating conditions to the device may reduce device reliability. Specified typical performance or functional operation of the device under Absolute Maximum Rating conditions is not implied.

The information in this publication is believed to be accurate and reliable. However, no responsibility is assumed by RF Micro Devices, Inc. ("RFMD") for its use, nor for any infringement of patents, or other rights of third parties, resulting from its use. No license is granted by implication or otherwise under any patent or patent rights of RFMD. RFMD reserves the right to change component circuitry, recommended application circuitry and specifications at any time without prior notice.



RFMD Green: RoHS compliant per EU Directive 2002/95/EC, halogen free per IEC 61249-2-21, < 1000 ppm each of antimony trioxide in polymeric materials and red phosphorus as a flame retardant, and <2% antimony in solder.

| Parameter | Specification | | | Unit | Condition |
|---|----------------|------|----------------|------|---|
| | Min. | Typ. | Max. | | |
| ESD Requirements | | | | | |
| Human Body Model | 2000 | | | V | DC Pins |
| | 1500 | | | V | All Pins |
| Charge Device Model | 500 | | | V | All Pins |
| Operating Conditions | | | | | |
| Supply voltage (V_{DD}) | 2.7 | 3.0 | 3.3 | V | |
| Temperature (T_{OP}) | -40 | | +85 | °C | |
| Logic Inputs/Outputs (V_{DD} = Supply to DIG_VDD pin) | | | | | |
| Input low voltage | -0.3 | | +0.5 | V | |
| Input high voltage | $V_{DD}/1.5$ | | V_{DD} | V | |
| Input low current | -10 | | +10 | μA | Input = 0V |
| Input high current | -10 | | +10 | μA | Input = V_{DD} |
| Output low voltage | 0 | | $0.2 * V_{DD}$ | V | |
| Output high voltage | $0.8 * V_{DD}$ | | V_{DD} | V | |
| Load resistance | 10 | | | kΩ | |
| Load capacitance | | | 20 | pF | |
| GPO Drive Capability | | | | | |
| Sink Current | | 20 | | mA | at $V_{OL} = 0.6V$ |
| Source Current | | 20 | | mA | at $V_{OL} = 2.4V$ |
| Output Impedance | | 25 | | Ω | |
| Static | | | | | |
| Supply Current (I_{DD}) with 1GHz LO | | 100 | | mA | Low current, MIX_IDD=1, one mixer enabled. |
| | | 125 | | mA | High linearity, MIX_IDD=6, one mixer enabled. |
| Standby | | | 2 | mA | Reference oscillator and bandgap only. |
| Power Down Current | | | 300 | μA | ENBL=0 and REF_STBY=0 |
| Mixer 1/2 (Mixer output driving 4:1 balun) | | | | | |
| Gain | | -2 | | dB | Not including balun losses |
| Noise Figure | | 10 | | dB | Low current setting |
| | | 13 | | dB | High linearity setting |
| IIP3 | | +10 | | dBm | Low current setting |
| | | +23 | | dBm | High linearity setting |
| Input port frequency range | 30 | | 2700 | MHz | |
| Mixer input return loss | | 10 | | dB | 100Ω differential |
| Output port frequency range | 30 | | 2700 | MHz | |

| Parameter | Specification | | | Unit | Condition |
|--|---------------|------|------|--------|--|
| | Min. | Typ. | Max. | | |
| Reference Oscillator | | | | | |
| External reference frequency | 10 | | 104 | MHz | |
| Reference divider ratio | 1 | | 7 | | |
| External reference input level | 500 | 800 | 1500 | mVp-p | AC-coupled |
| Synthesizer (Loop bandwidth of 200KHz, 52MHz reference) | | | | | |
| Synthesizer output frequency | 85 | | 2700 | MHz | |
| Phase detector frequency | | | 52 | MHz | |
| Phase noise (LO = 1GHz) | | -108 | | dBc/Hz | 10kHz offset |
| | | -108 | | dBc/Hz | 100kHz offset |
| | | -135 | | dBc/Hz | 1MHz offset |
| | | 0.19 | | ° | RMS integrated from 1kHz to 40MHz |
| Phase noise (LO = 2GHz) | | -102 | | dBc/Hz | 10kHz offset |
| | | -102 | | dBc/Hz | 100kHz offset |
| | | -130 | | dBc/Hz | 1MHz offset |
| | | 0.32 | | ° | RMS integrated from 1kHz to 40MHz |
| Normalized phase noise floor | | -214 | | dBc/Hz | Measured at 20kHz to 30kHz offset |
| Voltage Controlled Oscillator | | | | | |
| Open loop phase noise at 1MHz offset | | | | | |
| 2.5GHz LO frequency | | -134 | | dBc/Hz | VCO3 |
| 2.0GHz LO frequency | | -135 | | dBc/Hz | VCO2 |
| 1.5GHz LO frequency | | -136 | | dBc/Hz | VCO1 |
| Open loop phase noise at 10MHz offset | | | | | |
| 2.5GHz LO frequency | | -149 | | dBc/Hz | VCO3 |
| 2.0GHz LO frequency | | -150 | | dBc/Hz | VCO2 |
| 1.5GHz LO frequency | | -151 | | dBc/Hz | VCO1 |
| External LO Input | | | | | |
| LO Input Frequency Range | 85 | | 5400 | MHz | Note Minimum LO Divide by 2 at Mixer |
| External LO Input Level | | 0 | | dBm | Driven from 50Ω Source Via a 1:1 Balun |

Pin Names and Descriptions

| Pin | Name | Description |
|-----|----------------|--|
| 1 | ENBL/GPO5 | Device Enable pin. See note 1 and 2. |
| 2 | EXT_LO | External local oscillator input (see note 4). |
| 3 | EXT_LO_DEC | Decoupling pin for external local oscillator (see note 4). |
| 4 | REXT | External bandgap bias resistor. See note 3. |
| 5 | ANA_VDD1 | Analog supply. Use good RF decoupling. |
| 6 | LFILT1 | Phase detector output. Low-frequency noise-sensitive node. |
| 7 | LFILT2 | Loop filter op-amp output. Low-frequency noise-sensitive node. |
| 8 | LFILT3 | VCO control input. Low-frequency noise-sensitive node. |
| 9 | MODE/GPO6 | Mode select pin. See note 1 and 2. |
| 10 | REF_IN | Reference input. Use AC coupling capacitor. |
| 11 | NC | |
| 12 | TM | Connect to ground. |
| 13 | MIX1_IPN | Differential input 1 (see note 4). On RFFC2072 this pin is NC. |
| 14 | MIX1_IPP | Differential input 1 (see note 4). On RFFC2072 this pin is NC. |
| 15 | GPO1/ADD1 | General purpose output / MultiSlice address bit. |
| 16 | GPO2/ADD2 | General purpose output / MultiSlice address bit. |
| 17 | MIX1_OPN | Differential output 1 (see note 5). On RFFC2072 this pin is NC. |
| 18 | MIX1_OPP | Differential output 1 (see note 5). On RFFC2072 this pin is NC. |
| 19 | DIG_VDD | Digital supply. Should be decoupled as close to the pin as possible. |
| 20 | NC | |
| 21 | NC | |
| 22 | ANA_VDD2 | Analog supply. Use good RF decoupling. |
| 23 | MIX2_IPP | Differential input 2 (see note 4). |
| 24 | MIX2_IPN | Differential input 2 (see note 4). |
| 25 | GPO3/FM | General purpose output / frequency control input. |
| 26 | GPO4/LD/DO | General purpose output / Lock detect output / serial data out. |
| 27 | MIX2_OPN | Differential output 2 (see note 5). |
| 28 | MIX2_OPP | Differential output 2 (see note 5). |
| 29 | RESETX | Chip reset (active low). Connect to DIG_VDD if asynchronous reset is not required. |
| 30 | ENX | Serial interface select (active low). See note 1. |
| 31 | SCLK | Serial interface clock. See note 1. |
| 32 | SDATA | Serial interface data. See note 1. |
| | Exposed paddle | Ground reference, should be connected to PCB ground through a low impedance path. |

Note 1: An RC low pass filter could be used on this line to reduce digital noise.

Note 2: If the device is under software control this input can be configured as a general purpose output (GPO).

Note 3: Connect a 51kΩ resistor from this pin to ground, this pin is sensitive to low frequency noise injection.

Note 4: DC voltage should not be applied to this pin. Use either an AC-coupling capacitor as part of lumped element matching network or a transformer (see evaluation board schematic).

Note 5: This pin must be connected to ANA_VDD2 using an RF choke or a transformer (see application schematic).

Theory of Operation

The RFFC2071 and RFFC2072 are wideband RF frequency converter chips which include a fractional-N synthesizer and a low noise VCO core. The RFFC2071 has an LO signal multiplexer, two LO buffer circuits, and two RF mixers. The RFFC2072 has a single LO buffer circuit and one RF mixer. Both devices have an integrated voltage reference and low drop out regulators supplying critical circuit blocks such as the VCOs and synthesizer. Synthesizer programming, device configuration and control are achieved through a mixture of hardware and software controls. All on-chip registers are programmed through a simple 3-wire serial interface.

VCO

The VCO core in the RFFC2071 and RFFC2072 consists of three VCOs which, in conjunction with the integrated LO dividers of $/2$ to $/32$, cover the LO range of 85MHz to 2700MHz. Each VCO has 128 overlapping bands which are used to achieve low VCO gain and optimal phase noise performance across the whole tuning range. The chip automatically selects the correct VCO (VCO auto-select) and VCO band (VCO coarse tuning) to generate the desired LO frequency based on the values programmed into the PLL1 and PLL2 registers banks.

The VCO auto-select and VCO coarse tuning are triggered every time ENBL is taken high, or if the PLL re-lock self clearing bit is programmed high. Once the correct VCO and band have been selected the PLL will lock onto the correct frequency. During the band selection process, fixed capacitance elements are progressively connected to the VCO resonant circuit until the VCO is oscillating approximately at the correct frequency. The output of this band selection, CT_CAL, is made available in the read-back register. A value of 127 or 0 in this register indicates that the coarse tuning was unsuccessful, and this will also be indicated by the CT_FAILED flag also available in the read-back register. A CT_CAL value between 1 and 126 indicates a successful calibration, the actual value being dependent on the desired frequency as well as process variation for a particular device.

The band select process will center the VCO tuning voltage at about 1.0V, compensating for manufacturing tolerances and process variation as well as environmental factors including temperature. In applications where the device is left enabled at the same LO frequency for some time, it is recommended that automatic band selection be performed for every 30°C change in temperature. This assumes an active loop filter.

The RFFC2071 and RFFC2072 feature a differential LO input to allow the mixer to be driven from an external LO source. The fractional-N PLL can be used with an external VCO driven into this LO input, which may be useful to reduce phase noise in some applications. This may also require an external op-amp, dependant on the tuning voltage required by the external VCO.

In the RFFC2071 the LO signal is routed to mixer 1, mixer 2, or both mixers depending on the state of the MODE pin (or MODE bit if under software control) and the value of the FULLD bit. Setting FULLD high puts the device into Full Duplex mode and both mixers are enabled.

Fractional-N PLL

The RFFC2071 and RFFC2072 contain a charge pump-based fractional-N phase locked loop (PLL) for controlling the three VCOs. The PLL includes automatic calibration systems to counteract the effects of process and environmental variations, ensuring repeatable loop response and phase noise performance. As well as the VCO auto-select and coarse tuning, there is a loop filter calibration mechanism which can be enabled if required. This operates by adjusting the charge pump current to maintain loop bandwidth. This can be useful for applications where the LO is tuned over a wide frequency range.

The PLL has been designed to use a reference frequency of between 10MHz and 104MHz from an external source, which is typically a temperature controlled crystal oscillator (TCXO). A reference divider (divide by 1 to divide by 7) is supplied and should be programmed to limit the frequency at the phase detector to a maximum of 52MHz.

Two PLL programming banks are provided, the first bank is preceded by the label PLL1 and the second bank is preceded by the label PLL2. For the RFFC2071 these banks are used to program mixer 1 and mixer 2 respectively, and are selected automatically as the mixer is selected using MODE. For the RFFC2072 mixer 2 and register bank PLL2 are normally used.

The VCO outputs are first divided down in a high frequency prescaler. The output of this high frequency prescaler then enters the N divider, which is a fractional divider containing a dual-modulus prescaler and a digitally spur-compensated fractional

sequence generator. This allows very fine frequency steps and minimizes fractional spurs. The fractional energy is randomized and appears as fractional noise at frequency offsets above 100kHz which will be attenuated by the loop filter. An external loop filter is used, giving flexibility in setting loop bandwidth for optimizing phase noise and lock time, for example.

The synthesizer step size is typically 1.5Hz when using a 26MHz reference frequency. The exact step size for any reference and LO frequency can be calculated using the following formula:

$$(F_{REF} * P) / (R * 2^{24} * LO_DIV)$$

Where F_{REF} is the reference frequency, R is the reference division ratio, P is the prescaler division ratio, and LO_DIV is the LO divider value.

Pin 26 (GPO4) can be configured as a lock detect pin. The lock status is also available in the read-back register. The lock detect function is a window detector on the VCO tuning voltage. The lock flag will be high to show PLL lock which corresponds to the VCO tuning voltage being within the specified range, typically 0.30V to 1.25V.

The lock time of the PLL will depend on a number of factors; including the loop bandwidth and the reference frequency at the phase detector. This clock frequency determines the speed at which the state machine and internal calibrations run. A 52MHz phase detector frequency will give fastest lock times, of typically <50µsecs when using the PLL re-lock bit.

Phase Detector and Charge Pump

The phase detector provides a current output to drive an active loop filter. The charge pump output current is set by the value contained in the P1_CP_DEF and P2_CP_DEF fields in the loop filter configuration register. The charge pump current is given by approximately 3µA/bit, and the fields are 6 bits long. This gives default value (31) of 93µA and maximum value (63) of 189µA.

If the automatic loop bandwidth calibration is enabled the charge pump current is set by the calibration algorithm based upon the VCO gain.

The phase detector will operate with a maximum input frequency of 52MHz.

Loop Filter

The active loop filter is implemented using the on-chip low noise op-amp, with external resistors and capacitors. The op-amp gives a tuning voltage range of typically +0.1V to +2.4V. The internal configuration of the chip is shown below with the recommended active loop filter. The loop filter shown is designed to give lowest integrated phase noise, for reference frequencies of between 26MHz and 52MHz. The external loop filter components give the flexibility to optimize the loop response for any particular application and combination of reference and VCO frequencies.

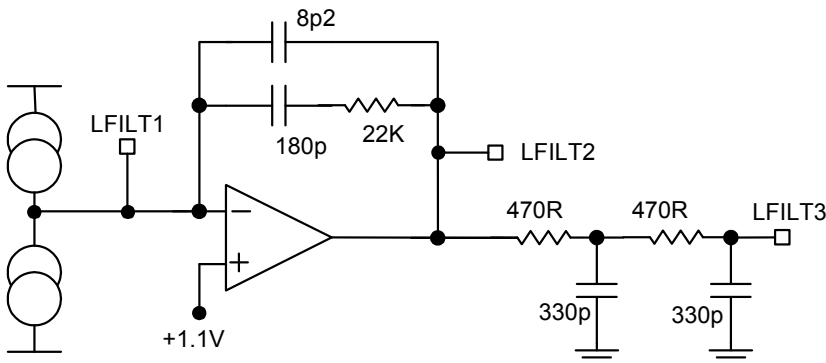

External Reference

The RFFC2071 and RFFC2072 have been designed to use an external reference such as a TCXO. The typical input will be a 0.8Vp-p clipped sine wave, which should be AC-coupled into the reference input. When the PLL is not in use, it may be desirable to turn off the internal reference circuits, by setting the REFSTBY bit low, to minimize current draw while in standby mode.

On cold start, or if REFSTBY is programmed low, the reference circuits will need a warm-up period. This is set by the SU_WAIT bits. This will allow the clock to be stable and immediately available when the ENBL bit is asserted high, allowing the PLL to assume normal operation.

If the current consumption of the reference circuits in standby mode, typically 2mA, is not critical, then the REFSTBY bit can be set high. This allows the fastest startup and lock time after ENBL is taken high.

Wideband Mixer

The mixers are wideband, double-balanced Gilbert cells. They support RF/IF frequencies from 30MHz up to 2700MHz. Each mixer has an input port and an output port that can be used for either IF or RF (in other words, for up- or down-conversion). The mixer current can be programmed to between about 15mA and 45mA depending on linearity requirements. The majority of the mixer current is sourced through the output pins via either a center-tapped balun or an RF choke in the external matching circuitry to the supply.

The RF mixer input and output ports are differential and require baluns and simple matching circuits optimized to the specific application frequencies. A conversion gain of approximately -2dB (not including balun losses) is achieved with 100Ω differential input impedance, and the outputs driving 200Ω differential load impedance. Increasing the mixer output load increases the conversion gain.

The mixer has a broadband common gate input. The input impedance is dominated by the resistance set by the mixer 1/gm term, which is inversely proportional to the mixer current setting. The resistance will be approximately 85Ω at the default mixer current setting (100). There is also some shunt capacitance at the mixer input, and the inductance of the bond wires (about 0.5nH on each pin) to consider at higher frequencies. The following diagram is a simple model of the mixer input impedance:

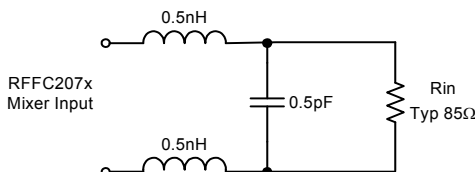

The mixer output is high impedance, consisting of approximately 2kΩ resistance in parallel with some capacitance, approximately 1pF. The mixer output does not require a conjugate matching network. It is a constant current output which will drive a real differential load of between 50Ω and 500Ω, typically 200Ω. Since the mixer output is a constant current source, a higher resistance load will give higher output voltage and gain. A shunt inductor can be used to resonate with the mixer output capacitance at the frequency of interest. This inductor may not be required at lower frequencies where the impedance of the output capacitance is less significant. At higher output frequencies the inductance of the bond wires (about 0.5nH on each pin) becomes more significant. The following diagram is a simple model of the mixer output:

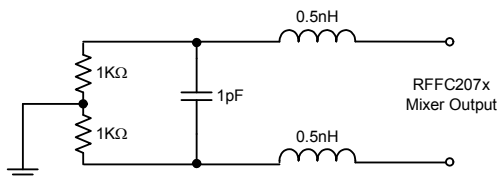

The RFFC2071 mixer layout and pin placement has been optimized for high mixer-to-mixer isolation of greater than 60dB. The mixers can be set up to operate in half duplex mode (1 mixer active) or full duplex mode (both mixers active). This selection is done via control of MODE and by setting the FULLD bit. When in full duplex mode, either PLL register bank can be used, the LO signal is routed to both mixers.

| Mode | FULLD | Active PLL Register Bank | Active Mixer |
|------|-------|--------------------------|--------------|
| LOW | 0 | 1 | 1 |
| HIGH | 0 | 2 | 2 |
| LOW | 1 | 1 | 1 and 2 |
| HIGH | 1 | 2 | 1 and 2 |

Serial Interface

All on-chip registers in the RFFC2071 and RFFC2072 are programmed using a proprietary 3-wire serial bus which supports both write and read operations. Synthesizer programming, device configuration, and control are achieved through a mixture of hardware and software controls. Certain functions and operations require the use of hardware controls via the ENBL, MODE, and RESETB pins in addition to programming via the serial bus. Alternatively there is the option to control the chip completely via the serial bus.

The serial data interface can be configured for 4-wire operation by setting the 4WIRE bit in the SDI_CTRL register high. Then pin 26 is used as the data out pin, and pin 32 is the serial data in pin.

Hardware Control

Three hardware control pins are provided: ENBL, MODE, and RESETB.

The ENBL pin has two functions: to enable the analog circuits in the chip and to trigger the VCO auto-selection and coarse tuning mechanisms. The VCO auto-selection and coarse tuning is initiated when the ENBL pin is taken high. Every time the frequency of the synthesizer is reprogrammed, ENBL has to be asserted high to initiate these mechanisms and then to initiate the PLL locking. Alternatively following the programming of a new frequency the PLL re-lock self clearing bit could be used.

If the device is left in the enabled state for long periods, it is recommended that VCO auto-selection and coarse tuning (band selection) is performed for every 30°C change in temperature. The lock detect flag can be used to indicate when to perform the VCO calibration, it shows that the VCO tuning voltage has drifted significantly with changing temperature.

The RESETB pin is a hardware reset control that will reset all digital circuits to their startup state when asserted low. The device includes a power-on-reset function, so this pin should not normally be required, in which case it should be connected to the positive supply.

The MODE pin controls which mixer(s) and PLL programming register bank is active.

Serial Data Interface Control

The normal mode of operation uses the 3-wire serial data interface to program the device registers, and three extra hardware control lines: MODE, ENBL and RESETB.

When the device is under software control, achieved by setting the SIPIN bit in the SDI_CTRL register high, then the hardware can be controlled via the SDI_CTRL register. When this is the case, the three hardware control lines are not required. If the device is under software control, pins 1 and 9 can be configured as general purpose outputs (GPO).

Multi-Slice Mode



The Multi-Slice mode of operation allows up to four chips to be controlled from a common serial bus. The device address pins (15 and 16) ADD1 and ADD2 are used to set the address of each part.

On power up, and after a reset, the devices ignore the address pins ADD1 and ADD2 and any data presented to the serial bus will be programmed into all the devices. However, once the ADDR bit in the SDI_CTRL register is set, each device then adopts an address according to the state of the address pins on the device.

General Purpose Outputs

The general purpose outputs (GPOs) can be controlled via the GPO register and will depend on the state of MODE since they can be set in different states corresponding to either mixer path 1 or 2. For example, the GPOs can be used to drive LEDs or to control external circuitry such as switches or low power LNAs.

Each GPO pin can supply approximately 20mA load current. The output voltage of the GPO high state will drop with increased current drive by approximately 25mV/mA. Similarly the output voltage of the GPO low state will rise with increased current, again by approximately 25mV/mA.

External Modulation

The RF2071 and RF2072 fractional-N synthesizer can be used to modulate the frequency of the VCO. There are two dedicated registers, EXT_MOD and FMOD, which can be used to configure the device as a modulator. It is possible to modulate the VCO in two ways:

1.Binary FSK

The MODSETUP bits in the EXT_MOD register are set to 11. GPO3 is then configured as an input and used to control the signal frequency. The frequency deviation is set by the MODSTEP and MODULATION bits in the EXT_MOD and FMOD registers respectively.

The modulation frequency is calculated according to the following formula:

$$F_{MOD} = 2^{MODSTEP} \cdot F_{PD} \cdot (MODULATION) / 2^{16}$$

Where MODULATION is a 2's complement number and F_{PD} is the phase detector frequency.

2.Continuous Modulation

The MODSETUP bits in the EXT_MOD register are set to 01. The frequency deviation is set by the MODSTEP and MODULATION bits in the EXT_MOD and FMOD registers respectively. The VCO frequency is then changed by writing a new value into the MOD-

ULATION bits, the VCO frequency is instantly updated. An arbitrary frequency modulation can then be performed dependant only on the rate at which values are written into the FMOD register.

The modulation frequency is calculated according to the following formula:

$$F_{MOD} = 2^{MODSTEP} \cdot F_{PD} \cdot (MODULATION) / 2^{16}$$

Where MODULATION is a 2's complement number and F_{PD} is the phase detector frequency.

Programming Information

The RFFC2071 and RFFC2072 share a common serial interface and control block. Please refer to the register map and programming guides which are available for download from <http://rfmd.com/products/IntSynthMixer/>.

Evaluation Boards

Evaluation boards for RFFC2071 and RFFC2072 are provided as part of a design kit, along with the necessary cables and programming software tool to enable full evaluation of the device. The evaluation board has been configured for wideband operation. The mixer inputs and outputs are connected to wideband transmission line transformer baluns. Design kits can be ordered from www.rfmd.com or from local RFMD sales offices and authorized sales channels. For ordering codes please see "Ordering Information" on page 23. For further details on how to set up the design kits please refer to the user guide which can be downloaded from <http://rfmd.com/products/IntSynthMixer/>.

Detailed Functional Block Diagram

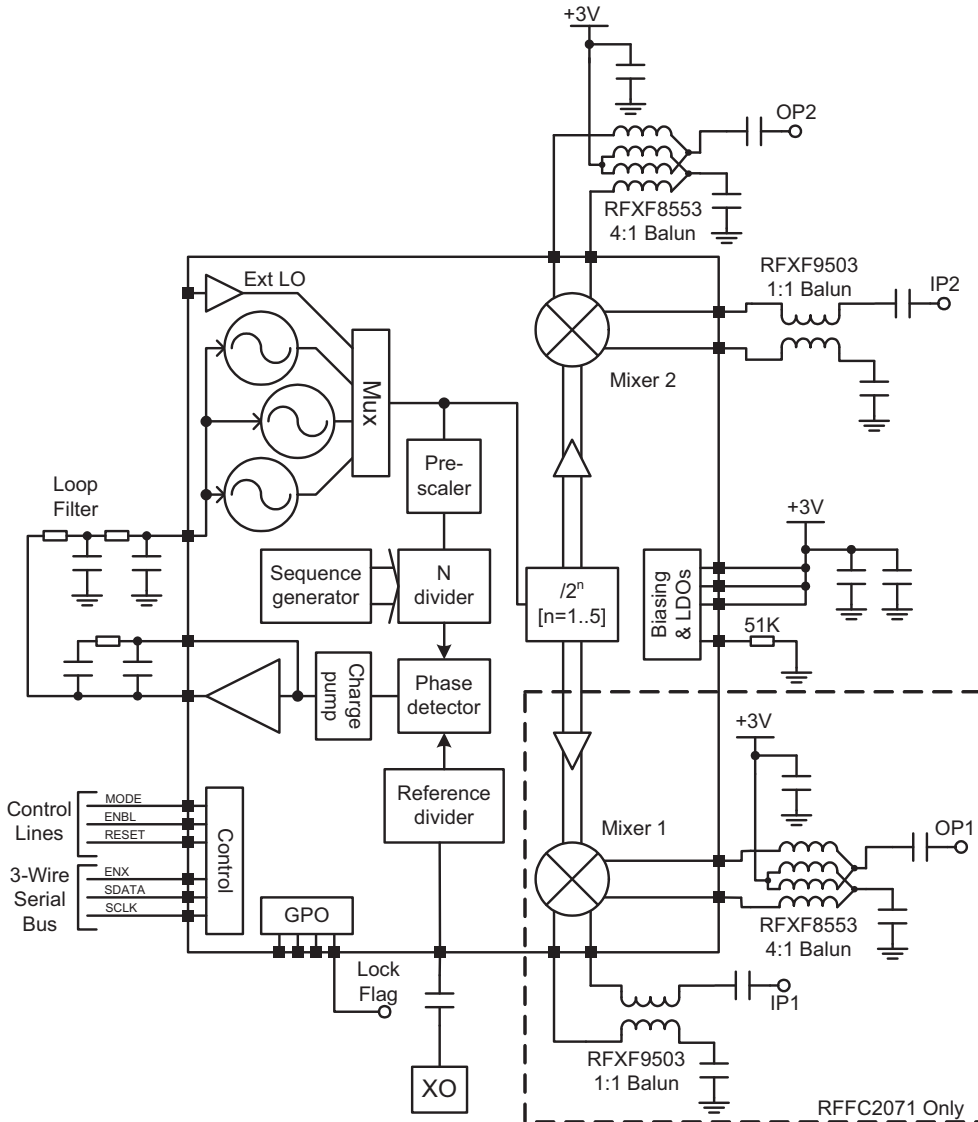

RFFC2071 Pin Out

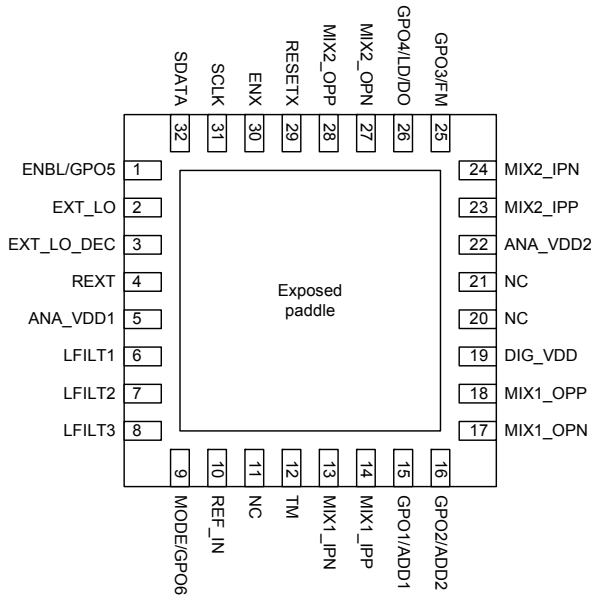

RFFC2072 Pin Out

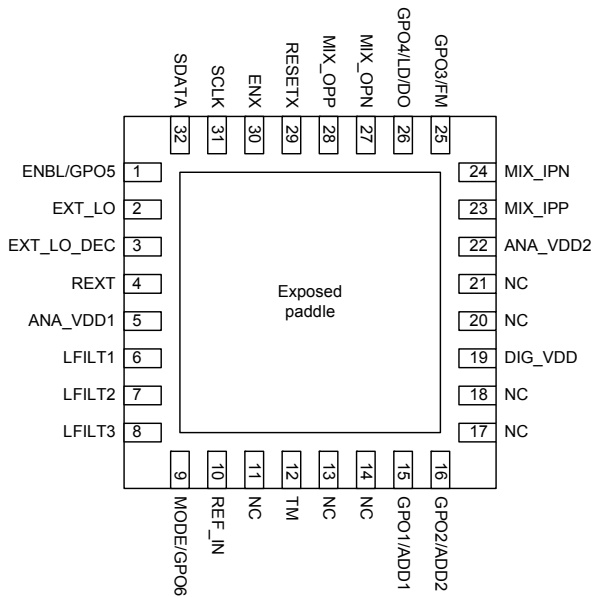

Typical Synthesizer Performance Characteristics

$V_{DD} = +3V$ and $T_A = +27^\circ C$ unless stated. Measured on RFRC2071/RFRC2072 evaluation board with active loop filter.

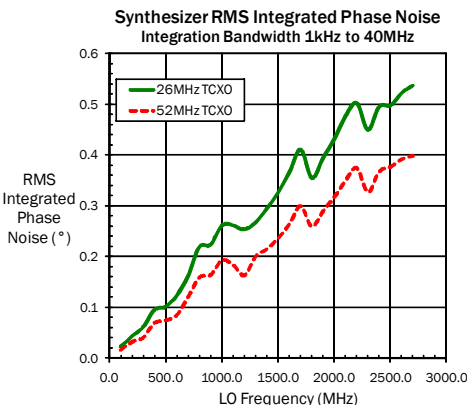
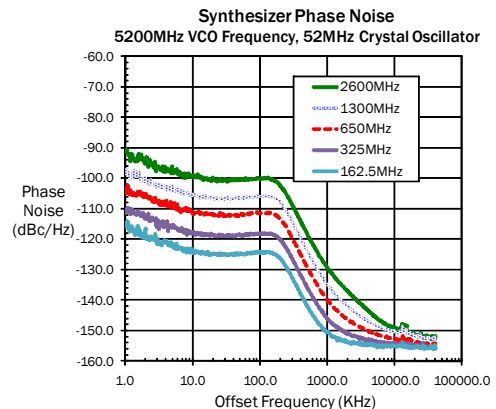
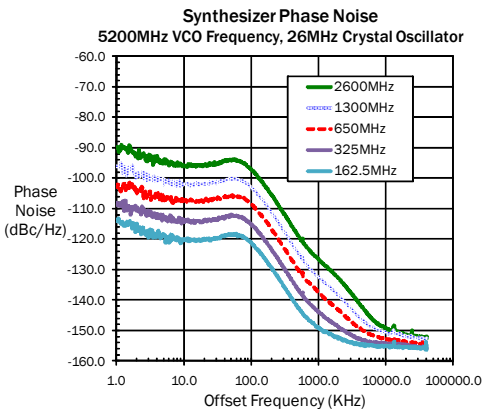
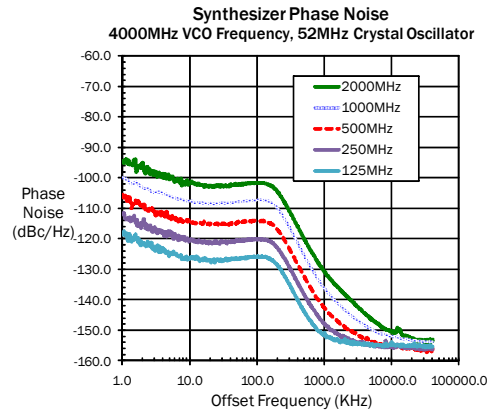
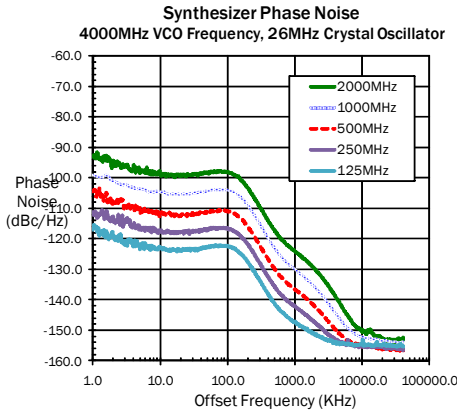

Note:

- 26MHz Crystal Oscillator: NDK ENA3523A
- 52MHz Crystal Oscillator: NDK ENA3560A

Typical VCO Performance Characteristics

$V_{DD} = +3V$ and $T_A = +27^\circ C$ unless stated. Measured on RFCF2071/RFCC2072 evaluation board.

VCO1 Frequency versus CT_CAL
VCO1 with LO Divide by 2

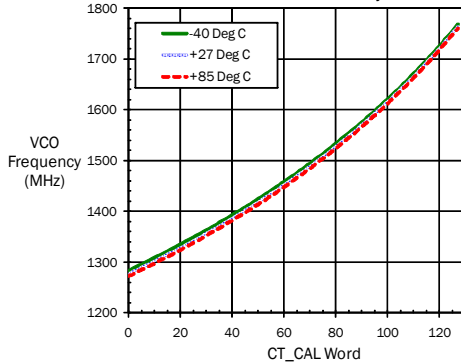

VCO1 Frequency versus Kvco
LO Divide by 2

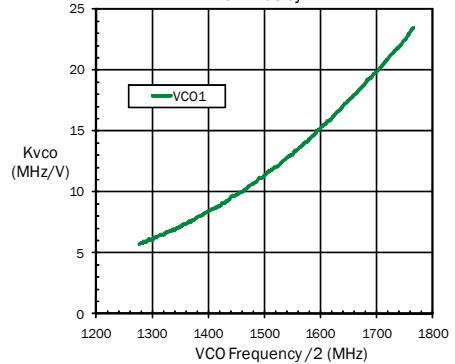

VCO2 Frequency versus CT_CAL
VCO2 with LO Divide by 2

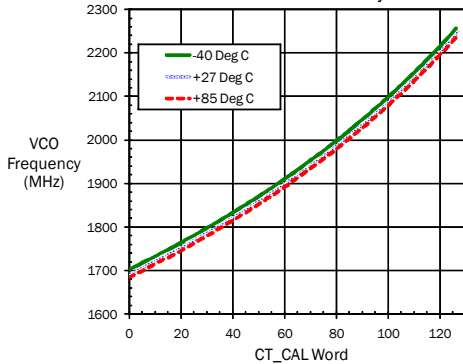

VCO2 Frequency versus Kvco
LO Divide by 2

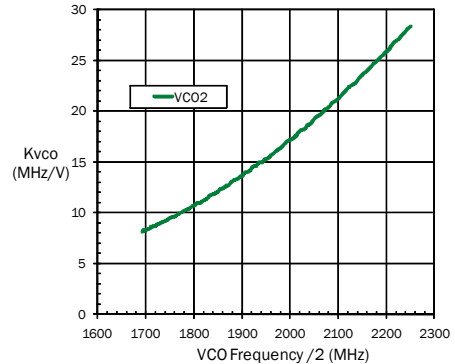

VCO3 Frequency versus CT_CAL
VCO3 with LO Divide by 2

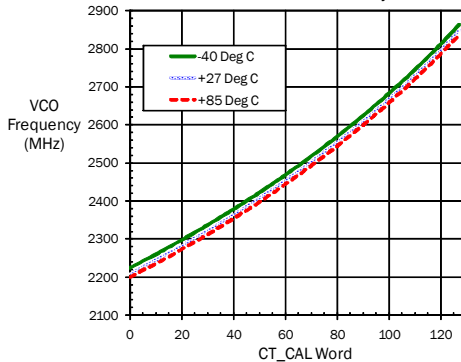

VCO3 Frequency versus Kvco
LO Divide by 2

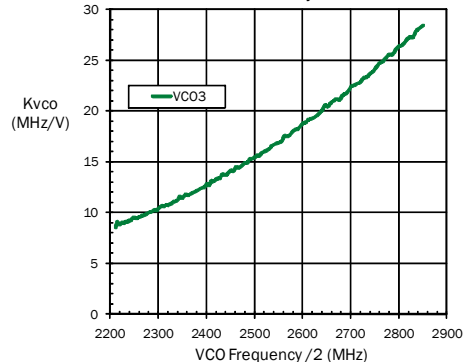

Typical VCO Performance Characteristics

$V_{DD} = +3V$ and $T_A = +27^\circ C$ unless stated. Measured on RFFC2071/RFFC2072 evaluation board.

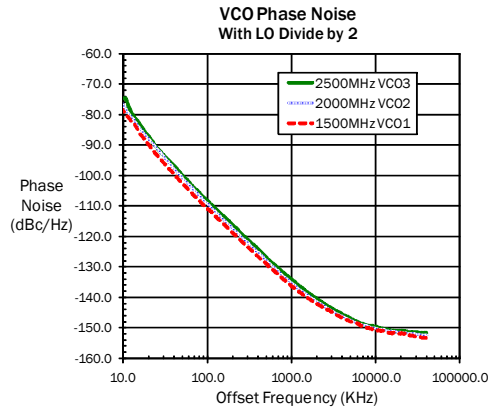
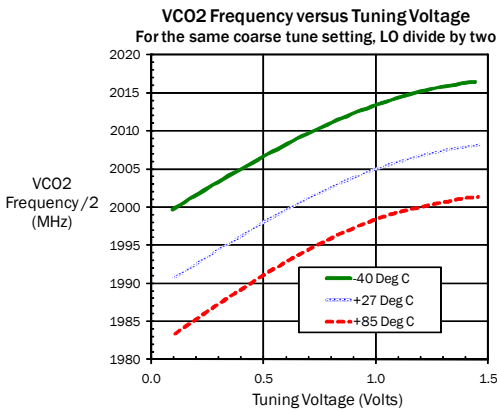
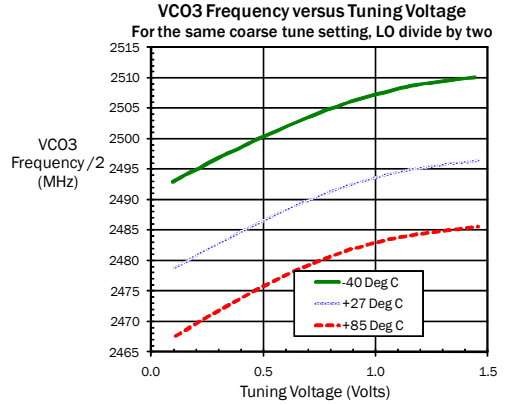
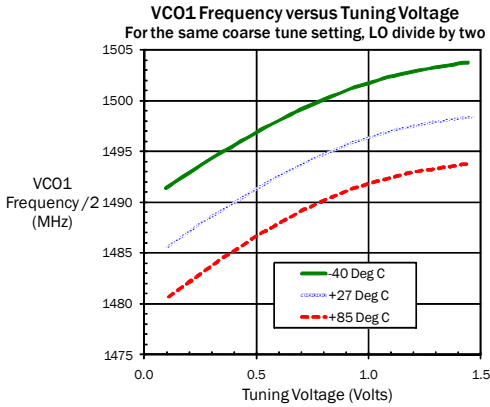

Typical Supply Current Performance Characteristics

$V_{DD} = +3V$ and $T_A = +27^\circ C$ unless stated.

Total Supply Current versus Mixer Bias Setting
One Mixer Enabled, LO Frequency = 1000MHz

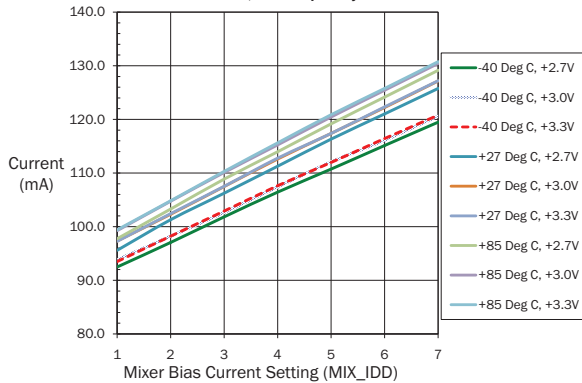

Total Supply Current versus LO Frequency
One Mixer Enabled, +3.0V Supply Voltage

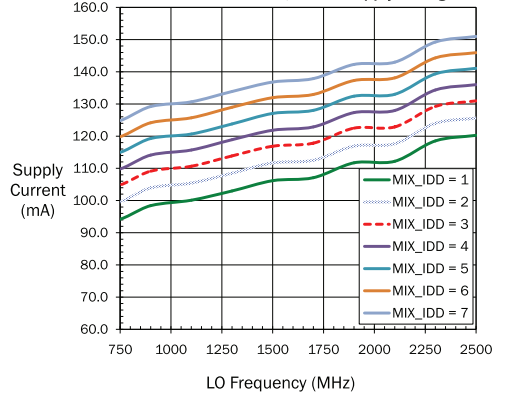

Typical RF Mixer 2 Performance Characteristics

$V_{DD} = +3V$ and $T_A = +27^\circ C$ unless stated. Measured on RFFC2071/RFFC2072 evaluation board.

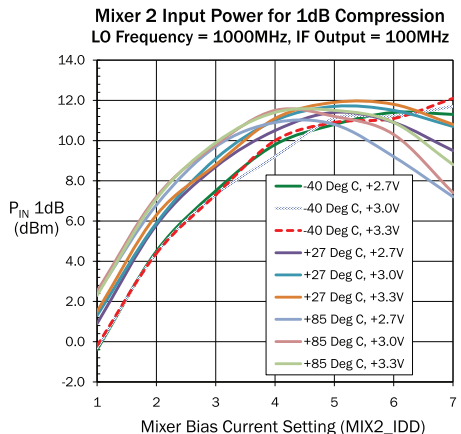
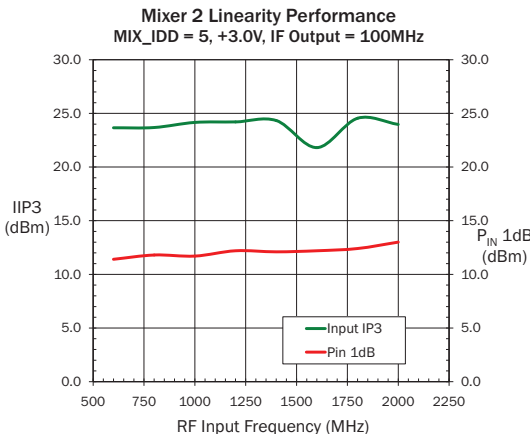
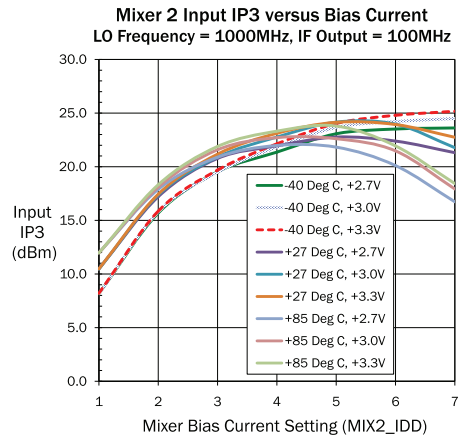
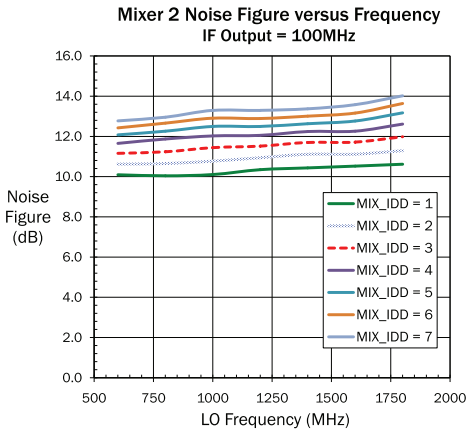
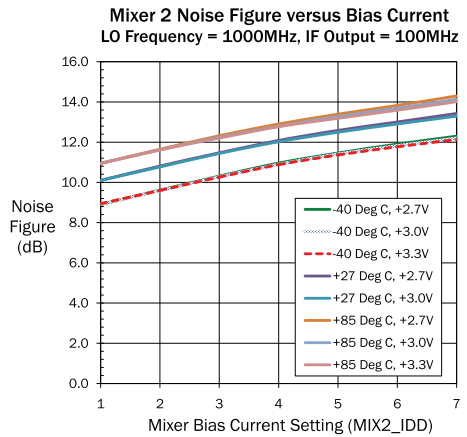
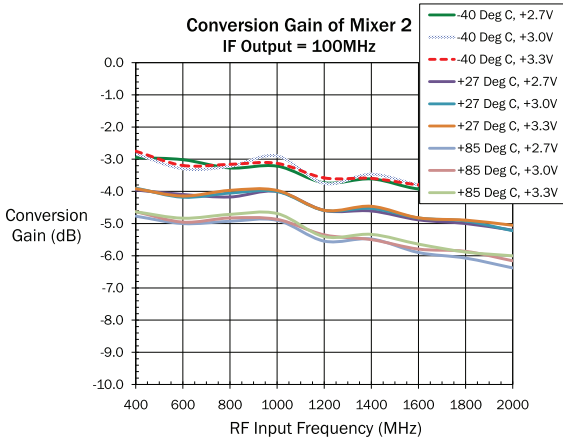

Typical RF Mixer 1 Performance Characteristics

$V_{DD} = +3V$ and $T_A = +27^\circ C$ unless stated. Measured on RFFC2071 evaluation board.

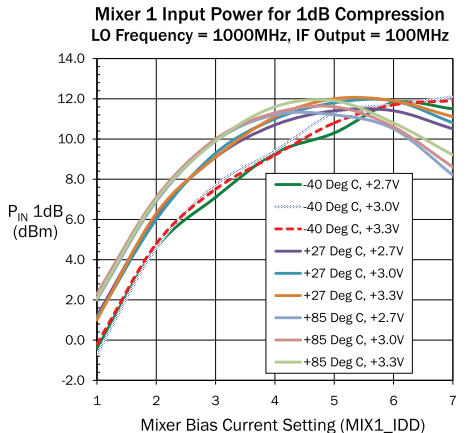
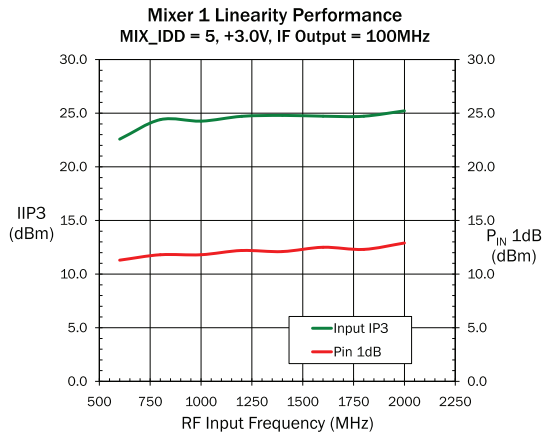
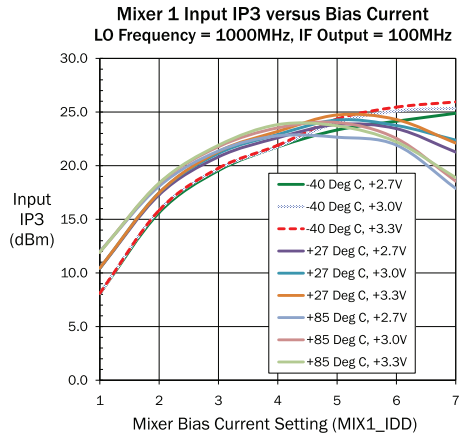
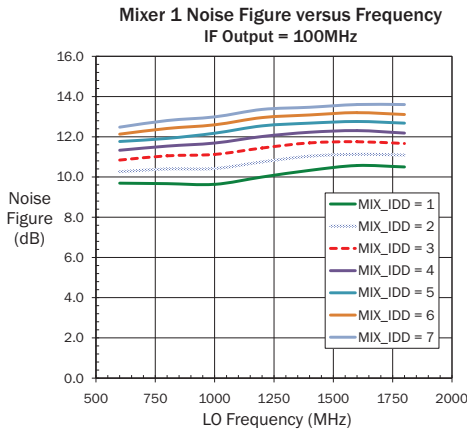
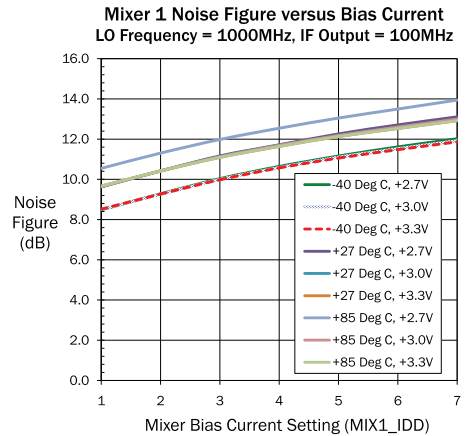
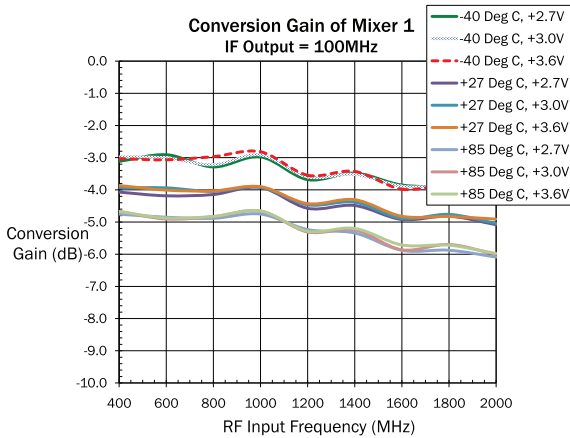

Typical Performance Characteristics of Both RF Mixers

$V_{DD} = +3V$ and $T_A = +27^\circ C$ unless stated. Measured on RFC2071 evaluation board.

LO & RF Leakage at Mixer 1 Output
RF Input Power 0dBm, MIX1_IDD = 4

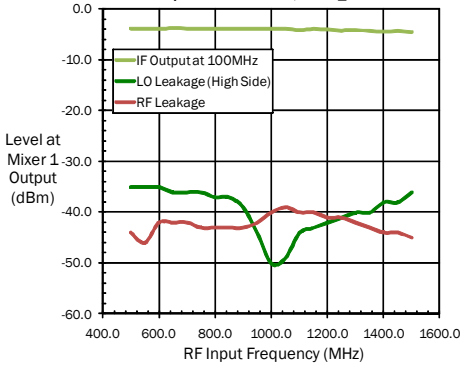

LO & RF Leakage at Mixer 2 Output
RF Input Power 0dBm, MIX2_IDD = 4

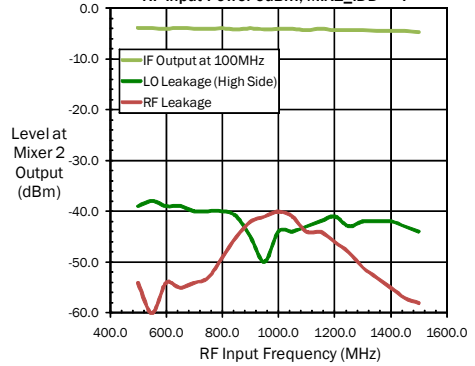

Typical LO Leakage at Mixer Output
+3.0V Supply Voltage

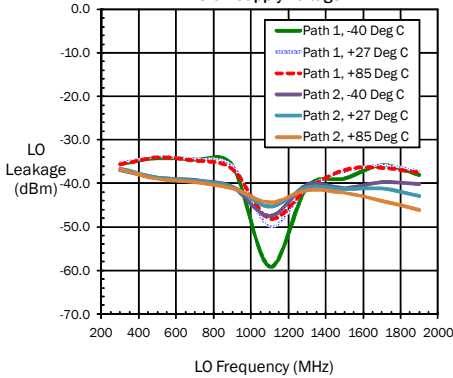

Typical Full Duplex Mode Performance Characteristics

$V_{DD} = +3V$ and $T_A = +27^\circ C$ unless stated. Measured on RFFC2071 evaluation board.

Mixer to Mixer Isolation in Full Duplex Mode
LO = RF input + 100MHz

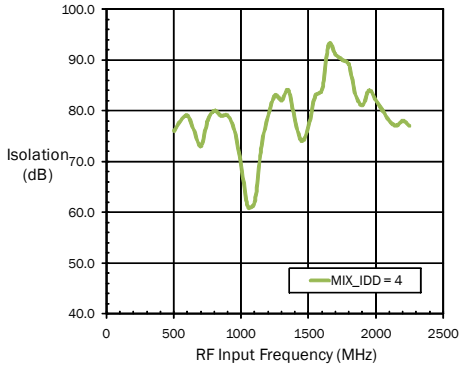

RFFC2071 typical operating current in mA. Full duplex mode (both mixers enabled) with +3V supply.

| MIX2_IDD | MIX1_IDD | | | | | | |
|----------|----------|-----|-----|-----|-----|-----|-----|
| | 1 | 2 | 3 | 4 | 5 | 6 | 7 |
| 1 | 121 | 126 | 131 | 136 | 142 | 146 | 151 |
| 2 | 126 | 131 | 136 | 141 | 147 | 151 | 156 |
| 3 | 131 | 136 | 141 | 147 | 152 | 156 | 161 |
| 4 | 136 | 141 | 147 | 152 | 157 | 162 | 167 |
| 5 | 141 | 146 | 152 | 157 | 162 | 167 | 172 |
| 6 | 146 | 151 | 156 | 161 | 167 | 171 | 176 |
| 7 | 151 | 156 | 161 | 166 | 171 | 176 | 181 |

Package Drawing QFN, 32-pin, 5mm x 5mm

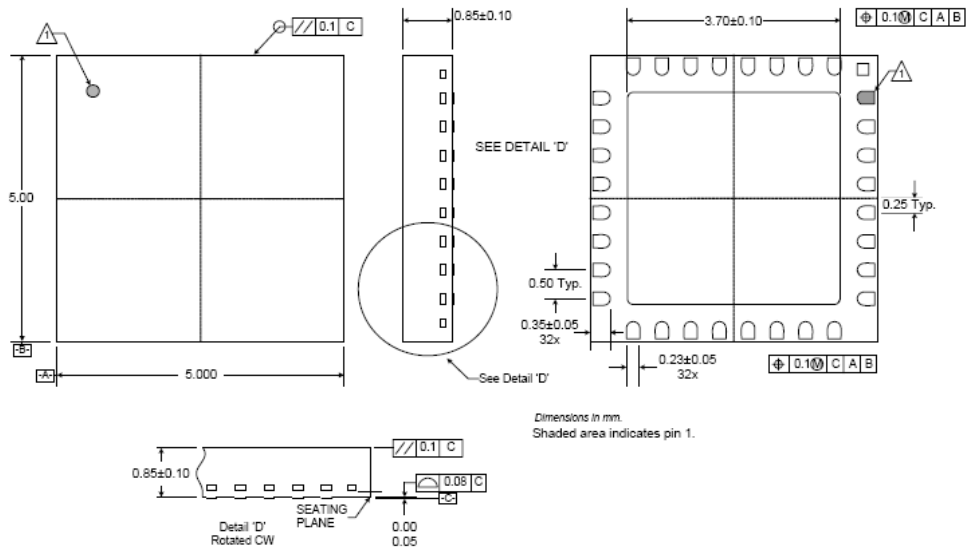

Ordering Information

RFFC2071

| Part Number | Description | Devices/Container |
|--------------|---------------------|---------------------|
| RFFC2071SB | 32-pin QFN | 5-Piece sample bag |
| RFFC2071SQ | 32-pin QFN | 25-Piece sample bag |
| RFFC2071SR | 32-pin QFN | 100-Piece reel |
| RFFC2071TR7 | 32-pin QFN | 750-Piece reel |
| RFFC2071TR13 | 32-pin QFN | 2500-Piece reel |
| DKFC2071 | Complete Design Kit | 1 Box |

RFFC2072

| Part Number | Description | Devices/Container |
|--------------|---------------------|---------------------|
| RFFC2072SB | 32-pin QFN | 5-Piece sample bag |
| RFFC2072SQ | 32-pin QFN | 25-Piece sample bag |
| RFFC2072SR | 32-pin QFN | 100-Piece reel |
| RFFC2072TR7 | 32-pin QFN | 750-Piece reel |
| RFFC2072TR13 | 32-pin QFN | 2500-Piece reel |
| DKFC2072 | Complete Design Kit | 1 Box |

Данный компонент на территории Российской Федерации

Вы можете приобрести в компании MosChip.

Для оперативного оформления запроса Вам необходимо перейти по данной ссылке:

<http://moschip.ru/get-element>

Вы можете разместить у нас заказ для любого Вашего проекта, будь то серийное производство или разработка единичного прибора.

В нашем ассортименте представлены ведущие мировые производители активных и пассивных электронных компонентов.

Нашей специализацией является поставка электронной компонентной базы двойного назначения, продукции таких производителей как XILINX, Intel (ex.ALTERA), Vicor, Microchip, Texas Instruments, Analog Devices, Mini-Circuits, Amphenol, Glenair.

Сотрудничество с глобальными дистрибьюторами электронных компонентов, предоставляет возможность заказывать и получать с международных складов практически любой перечень компонентов в оптимальные для Вас сроки.

На всех этапах разработки и производства наши партнеры могут получить квалифицированную поддержку опытных инженеров.

Система менеджмента качества компании отвечает требованиям в соответствии с ГОСТ Р ИСО 9001, ГОСТ РВ 0015-002 и ЭС РД 009

Офис по работе с юридическими лицами:

105318, г.Москва, ул.Щербаковская д.3, офис 1107, 1118, ДЦ «Щербаковский»

Телефон: +7 495 668-12-70 (многоканальный)

Факс: +7 495 668-12-70 (доб.304)

E-mail: info@moschip.ru

Skype отдела продаж:

moschip.ru

moschip.ru_4

moschip.ru_6

moschip.ru_9