

## LENA-WAS

Asymmetric beam for wall-washing

### TECHNICAL SPECIFICATIONS:

Dimensions	Ø 111.0 mm
Height	37 mm
Fastening	glue
ROHS compliant	yes 

### MATERIAL SPECIFICATIONS:

Component	Type	Material	Colour	Finish	Coating
LENA-WAS	Reflector	PC	metal		lacquer





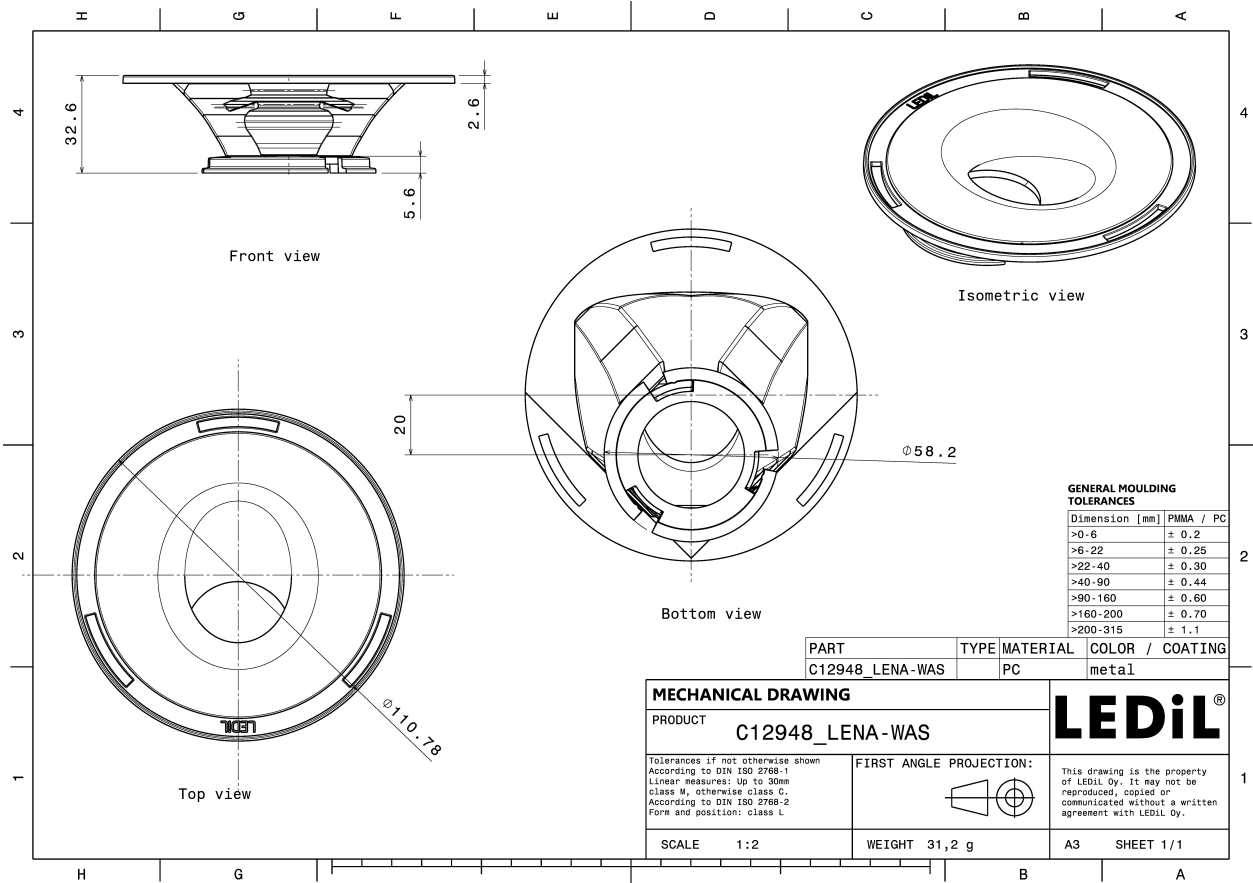

### ORDERING INFORMATION:

Component	Qty in box	MOQ	MPQ	Box weight (kg)
C12948_LENA-WAS » Box size: 480 x 280 x 300 mm	56	56	56	3.1



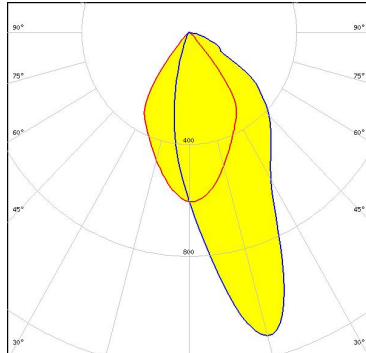
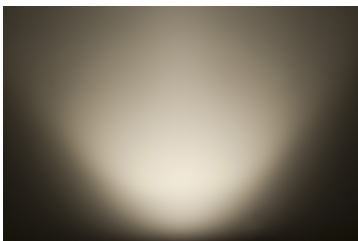
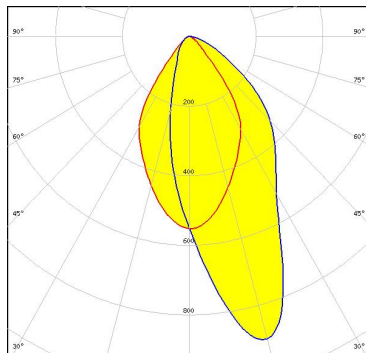

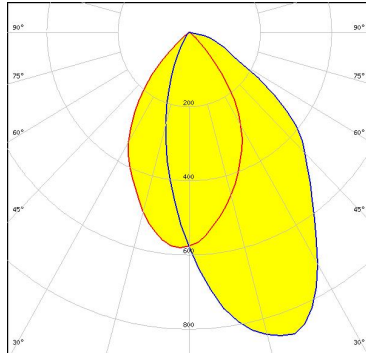
#### PHOTOMETRIC DATA (MEASURED):

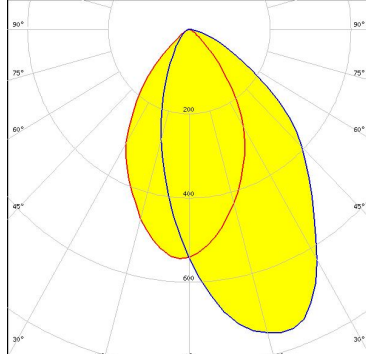
<p>bridgelux.</p> <p>LED BXRA ES Rectangle</p> <p>FWHM Asymmetric</p> <p>Efficiency 80 %</p> <p>Peak intensity 1.1 cd/lm</p> <p>LEDs/each optic 1</p> <p>Light colour White</p> <p>Required components: C12153_LENA-STD-BASE-BXRA</p>		
<p>bridgelux.</p> <p>LED BXRA ES Rectangle</p> <p>FWHM Asymmetric</p> <p>Efficiency 77 %</p> <p>Peak intensity 0.5 cd/lm</p> <p>LEDs/each optic 1</p> <p>Light colour White</p> <p>Required components: C12153_LENA-STD-BASE-BXRA C11996_LENA-LENS</p>		
<p>bridgelux.</p> <p>LED BXRA RS</p> <p>FWHM Asymmetric</p> <p>Efficiency 80 %</p> <p>Peak intensity 0.9 cd/lm</p> <p>LEDs/each optic 1</p> <p>Light colour White</p> <p>Required components: C12229_LENA-STD-BASE-RS</p>		
<p>bridgelux.</p> <p>LED BXRA RS</p> <p>FWHM Asymmetric</p> <p>Efficiency 75 %</p> <p>Peak intensity 0.8 cd/lm</p> <p>LEDs/each optic 1</p> <p>Light colour White</p> <p>Required components: C12229_LENA-STD-BASE-RS C11996_LENA-LENS</p>		

### PHOTOMETRIC DATA (MEASURED):

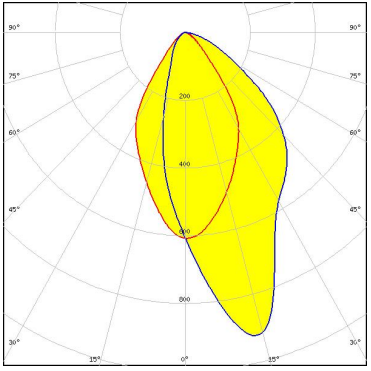
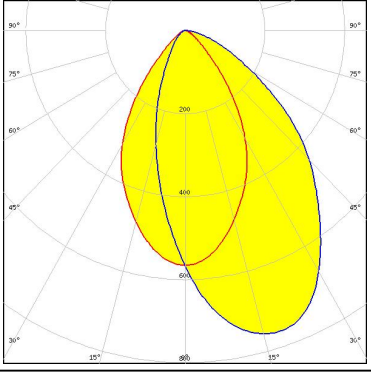
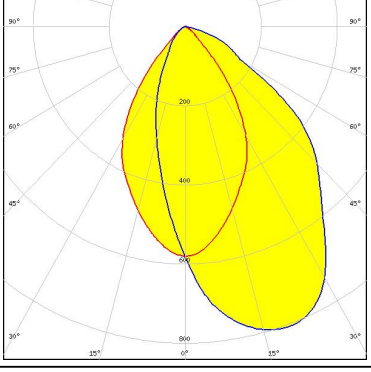
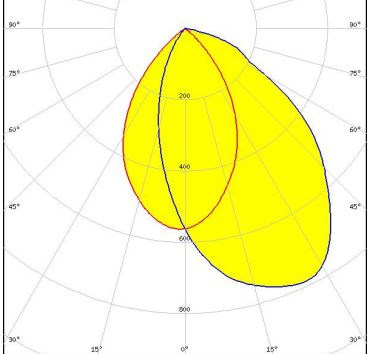
<p>bridgelux.</p> <p>LED V10 Gen6 FWHM Asymmetric Efficiency 83 % Peak intensity 0.9 cd/lm LEDs/each optic 1 Light colour White Required components: C13186_LENA-STD-BASE-CXA15 C11996_LENA-LENS</p>		
<p>bridgelux.</p> <p>LED V22 Gen7 FWHM Asymmetric Efficiency 82 % Peak intensity 0.8 cd/lm LEDs/each optic 1 Light colour White Required components: C13867_LENA-STD-BASE-VERO29 C11996_LENA-LENS Bender Wirth: 431 Typ L3</p>		
<p>bridgelux.</p> <p>LED V22 Gen7 FWHM Asymmetric Efficiency 84 % Peak intensity 0.8 cd/lm LEDs/each optic 1 Light colour White Required components: C13867_LENA-STD-BASE-VERO29 C14169_LENA-CLEAR-LENS Bender Wirth: 431 Typ L3</p>		
<p>bridgelux.</p> <p>LED Vero SE 29 FWHM Asymmetric Efficiency 87 % Peak intensity 0.8 cd/lm LEDs/each optic 1 Light colour White Required components: C15083_LENA-STD-BASE-VERO29</p>		

#### PHOTOMETRIC DATA (MEASURED):

<p>bridgelux.</p> <p>LED VERO13            FWHM Asymmetric            Efficiency 91 %            Peak intensity 1.3 cd/lm            LEDs/each optic 1            Light colour White            Required components:            C13868_LENA-STD-BASE-VERO13-18</p>	
<p>bridgelux.</p> <p>LED VERO13            FWHM Asymmetric            Efficiency 87 %            Peak intensity 0.5 cd/lm            LEDs/each optic 1            Light colour White            Required components:            C13868_LENA-STD-BASE-VERO13-18            C11996_LENA-LENS</p>	
<p>bridgelux.</p> <p>LED VERO13            FWHM Asymmetric            Efficiency 87 %            Peak intensity 1.1 cd/lm            LEDs/each optic 1            Light colour White            Required components:            C13868_LENA-STD-BASE-VERO13-18            C11996_LENA-LENS</p>	
<p>bridgelux.</p> <p>LED VERO18            FWHM Asymmetric            Efficiency 90 %            Peak intensity 1.1 cd/lm            LEDs/each optic 1            Light colour White            Required components:            C13868_LENA-STD-BASE-VERO13-18</p>	

#### PHOTOMETRIC DATA (MEASURED):

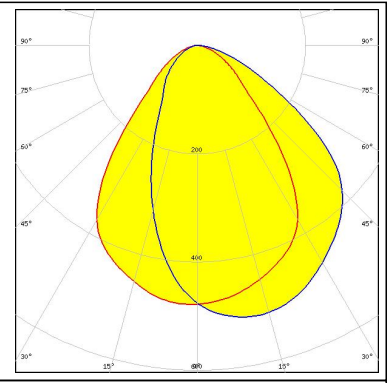
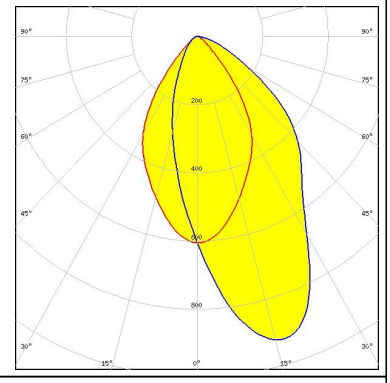
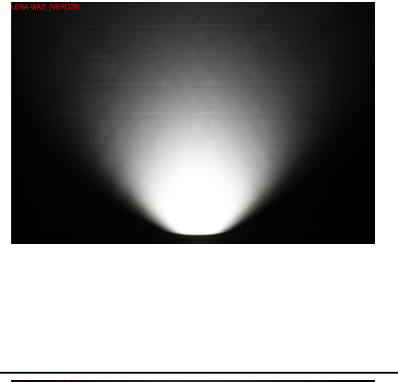
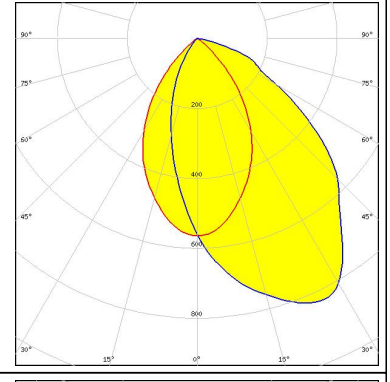
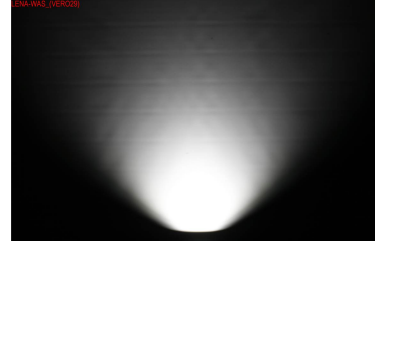
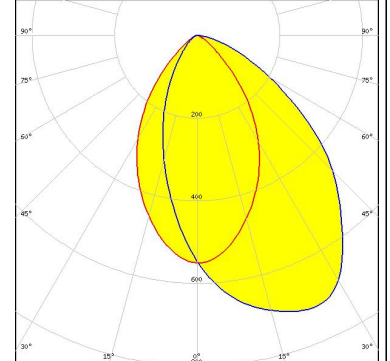
<p>bridgelux.</p> <p>LED VERO18</p> <p>FWHM Asymmetric</p> <p>Efficiency 87 %</p> <p>Peak intensity 0.5 cd/lm</p> <p>LEDs/each optic 1</p> <p>Light colour White</p> <p>Required components: C13868_LENA-STD-BASE-VERO13-18 C11996_LENA-LENS</p>		
<p>bridgelux.</p> <p>LED VERO18</p> <p>FWHM Asymmetric</p> <p>Efficiency 86 %</p> <p>Peak intensity 0.9 cd/lm</p> <p>LEDs/each optic 1</p> <p>Light colour White</p> <p>Required components: C13868_LENA-STD-BASE-VERO13-18 C11996_LENA-LENS</p>		
<p>bridgelux.</p> <p>LED VERO29</p> <p>FWHM Asymmetric</p> <p>Efficiency 87 %</p> <p>Peak intensity 0.8 cd/lm</p> <p>LEDs/each optic 1</p> <p>Light colour White</p> <p>Required components: C13867_LENA-STD-BASE-VERO29</p>		
<p>bridgelux.</p> <p>LED VERO29</p> <p>FWHM Asymmetric</p> <p>Efficiency 82 %</p> <p>Peak intensity 0.7 cd/lm</p> <p>LEDs/each optic 1</p> <p>Light colour White</p> <p>Required components: C13867_LENA-STD-BASE-VERO29 C11996_LENA-LENS</p>		

#### PHOTOMETRIC DATA (MEASURED):

#### CITIZEN

LED CL-L340  
 FWHM Asymmetric  
 Efficiency 84 %  
 Peak intensity 1.2 cd/lm  
 LEDs/each optic 1  
 Light colour White  
 Required components:  
 C11995\_LENA-STD-BASE-CL340

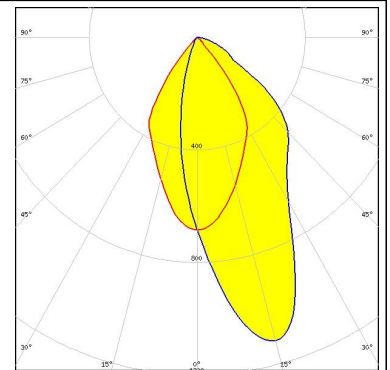

#### CITIZEN

LED CL-L340  
 FWHM Asymmetric  
 Efficiency 73 %  
 Peak intensity 0.9 cd/lm  
 LEDs/each optic 1  
 Light colour White  
 Required components:  
 C11995\_LENA-STD-BASE-CL340  
 C11996\_LENA-LENS

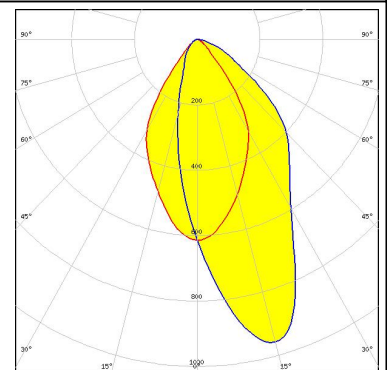
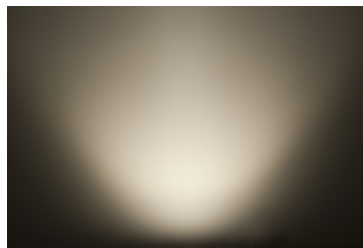

#### CITIZEN

LED CLL03x/CLU03x  
 FWHM Asymmetric  
 Efficiency 76 %  
 Peak intensity 1 cd/lm  
 LEDs/each optic 1  
 Light colour White  
 Required components:  
 C12691\_LENA-STD-BASE-CLL030  
 C11996\_LENA-LENS

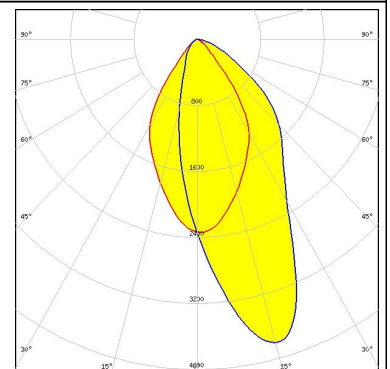
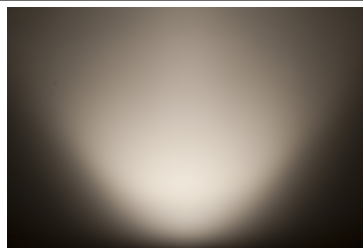

#### CITIZEN

LED CLL03x/CLU03x  
 FWHM Asymmetric  
 Efficiency 85 %  
 Peak intensity 0.9 cd/lm  
 LEDs/each optic 1  
 Light colour White  
 Required components:  
 C13868\_LENA-STD-BASE-VERO13-18  
 C11996\_LENA-LENS  
 Bender Wirth: 433 Typ L1

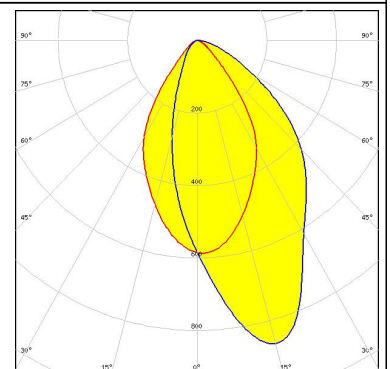
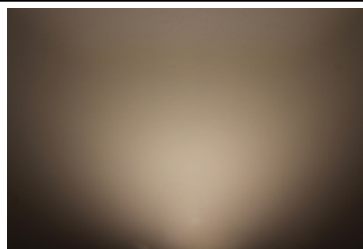



#### PHOTOMETRIC DATA (MEASURED):

#### CITIZEN

LED CLL03x/CLU03x  
 FWHM Asymmetric  
 Efficiency 90 %  
 Peak intensity 1.1 cd/lm  
 LEDs/each optic 1  
 Light colour White  
 Required components:  
 C13868\_LENA-STD-BASE-VERO13-18  
 Bender Wirth: 433 Typ L1

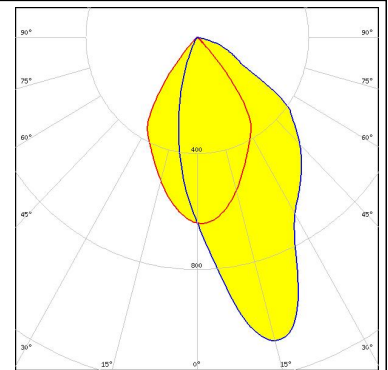
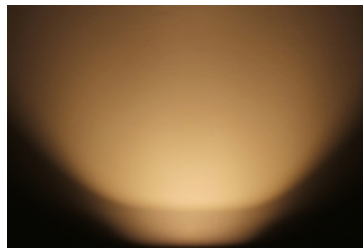

#### CITIZEN

LED CLL03x/CLU03x  
 FWHM Asymmetric  
 Efficiency 87 %  
 Peak intensity 0.5 cd/lm  
 LEDs/each optic 1  
 Light colour White  
 Required components:  
 C13868\_LENA-STD-BASE-VERO13-18  
 C11996\_LENA-LENS  
 Bender Wirth: 433 Typ L1

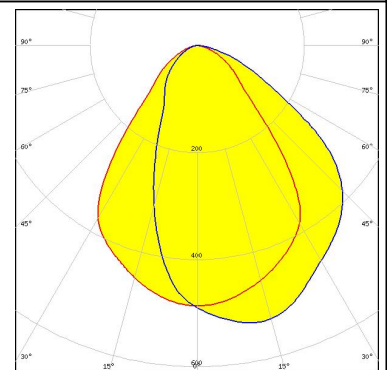
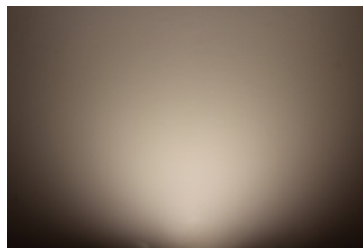

#### CITIZEN

LED CLL03x/CLU03x  
 FWHM Asymmetric  
 Efficiency 87 %  
 Peak intensity 1.1 cd/lm  
 LEDs/each optic 1  
 Light colour White  
 Required components:  
 A.A.G. STUCCHI: 8101/G2 + S-8000/11

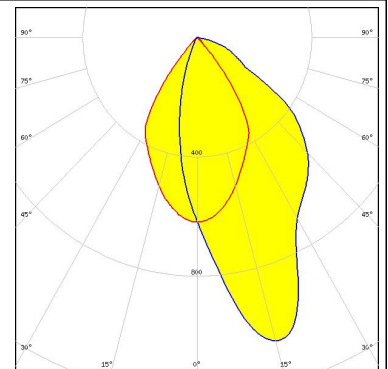

#### CITIZEN

LED CLL03x/CLU03x  
 FWHM Asymmetric  
 Efficiency 81 %  
 Peak intensity 1.2 cd/lm  
 LEDs/each optic 1  
 Light colour White  
 Required components:  
 C12691\_LENA-STD-BASE-CLL030

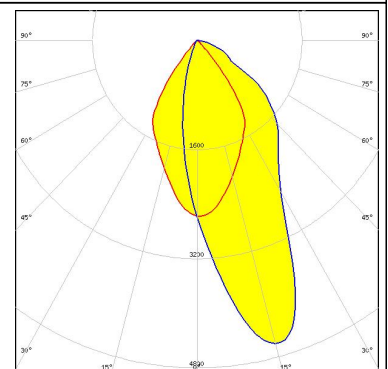
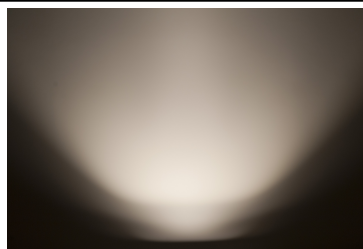

#### PHOTOMETRIC DATA (MEASURED):

#### CITIZEN

LED CLL03x/CLU03x  
 FWHM Asymmetric  
 Efficiency 90 %  
 Peak intensity 1.1 cd/lm  
 LEDs/each optic 1  
 Light colour White  
 Required components:  
 C13867\_LENA-STD-BASE-VERO29  
 Bender Wirth: 433 Typ L1

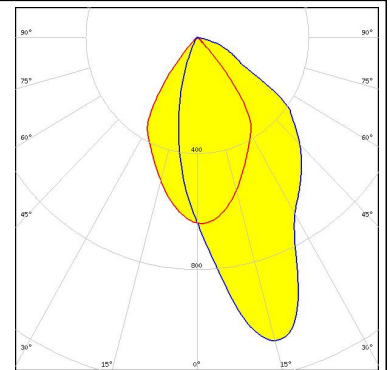
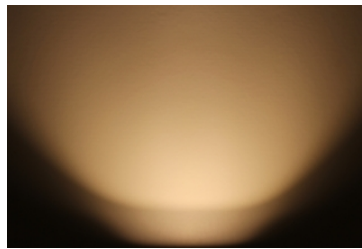

#### CITIZEN

LED CLL04x/CLU04x  
 FWHM Asymmetric  
 Efficiency 89 %  
 Peak intensity 0.9 cd/lm  
 LEDs/each optic 1  
 Light colour White  
 Required components:  
 C13867\_LENA-STD-BASE-VERO29  
 Bender Wirth: 431 Typ L3

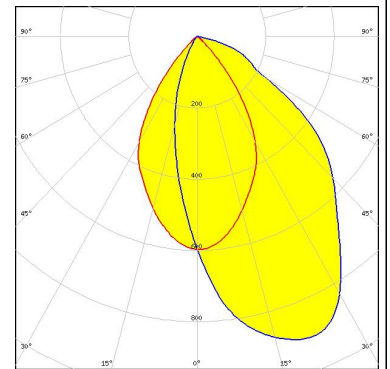
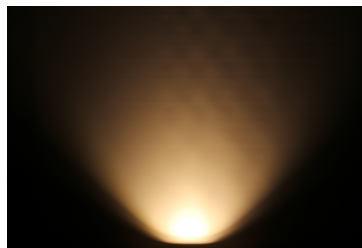

#### CITIZEN

LED CLL04x/CLU04x  
 FWHM Asymmetric  
 Efficiency 82 %  
 Peak intensity 1 cd/lm  
 LEDs/each optic 1  
 Light colour White  
 Required components:  
 C12692\_LENA-STD-BASE-CLL040

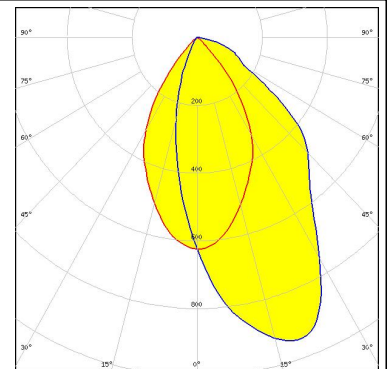
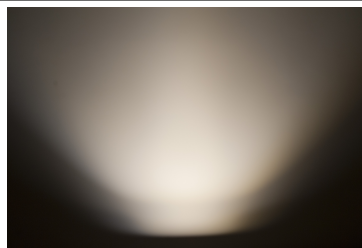

#### CITIZEN

LED CLL04x/CLU04x  
 FWHM Asymmetric  
 Efficiency 84 %  
 Peak intensity 0.8 cd/lm  
 LEDs/each optic 1  
 Light colour White  
 Required components:  
 C13867\_LENA-STD-BASE-VERO29  
 C11996\_LENA-LENS  
 Bender Wirth: 431 Typ L3

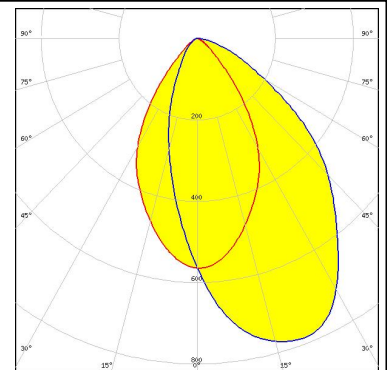

#### PHOTOMETRIC DATA (MEASURED):

#### CITIZEN

LED CLL04x/CLU04x  
 FWHM Asymmetric  
 Efficiency 78 %  
 Peak intensity 0.8 cd/lm  
 LEDs/each optic 1  
 Light colour White  
 Required components:  
 C12692\_LENA-STD-BASE-CLL040  
 C11996\_LENA-LENS

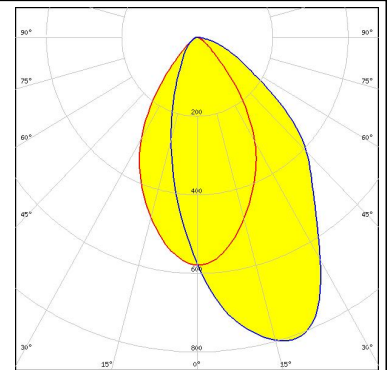
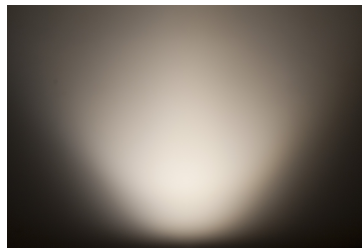

#### CITIZEN

LED CLL04x/CLU04x  
 FWHM Asymmetric  
 Efficiency 80 %  
 Peak intensity 0.8 cd/lm  
 LEDs/each optic 1  
 Light colour White  
 Required components:  
 A.A.G. STUCCHI: 8102/G2 + S-8000/12

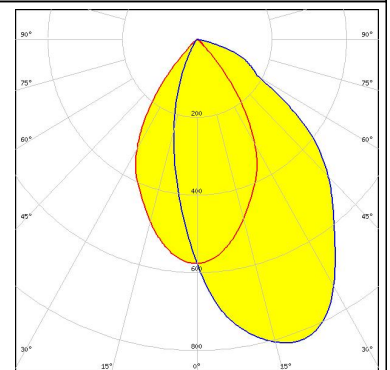

#### CITIZEN

LED CLL04x/CLU04x  
 FWHM Asymmetric  
 Efficiency 74 %  
 Peak intensity 0.6 cd/lm  
 LEDs/each optic 1  
 Light colour White  
 Required components:  
 C11996\_LENA-LENS  
 A.A.G. STUCCHI: 8102/G2 + S-8000/12

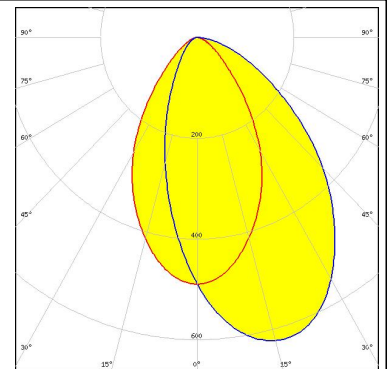

#### CITIZEN

LED CLL04x/CLU04x  
 FWHM Asymmetric  
 Efficiency 82 %  
 Peak intensity 0.7 cd/lm  
 LEDs/each optic 1  
 Light colour White  
 Required components:  
 C11996\_LENA-LENS  
 IDEAL: 50-2204CT + 50-2100LN

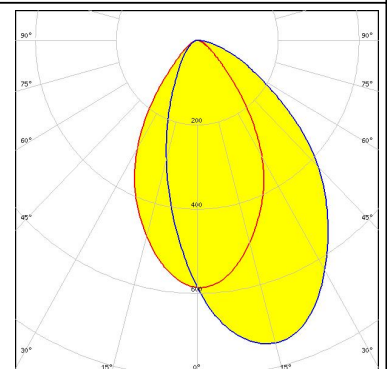
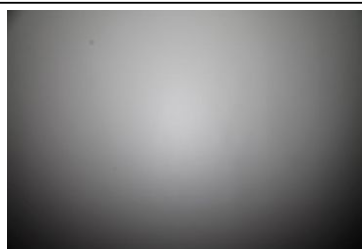



#### PHOTOMETRIC DATA (MEASURED):

#### CITIZEN

LED CLU700/701/702  
 FWHM Asymmetric  
 Efficiency 84 %  
 Peak intensity 1 cd/lm  
 LEDs/each optic 1  
 Light colour White  
 Required components:  
 C13868\_LENA-STD-BASE-VERO13-18  
 C11996\_LENA-LENS  
 Bender Wirth: 434 Typ L1

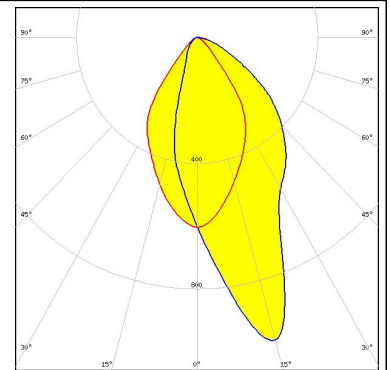

#### CITIZEN

LED CLU700/701/702  
 FWHM Asymmetric  
 Efficiency 89 %  
 Peak intensity 1.3 cd/lm  
 LEDs/each optic 1  
 Light colour White  
 Required components:  
 C13868\_LENA-STD-BASE-VERO13-18  
 Bender Wirth: 434 Typ L1

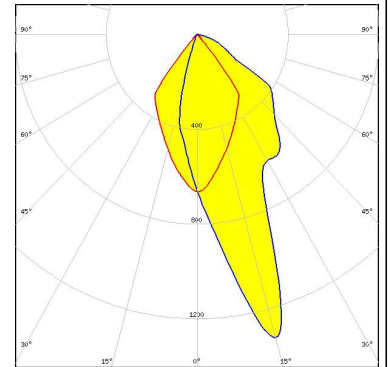
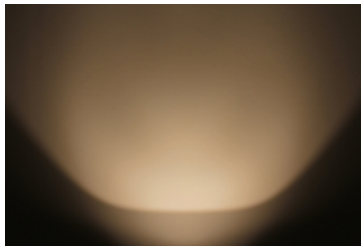

#### CITIZEN

LED CLU710/711  
 FWHM Asymmetric  
 Efficiency 89 %  
 Peak intensity 1.2 cd/lm  
 LEDs/each optic 1  
 Light colour White  
 Required components:  
 C12691\_LENA-STD-BASE-CLL030

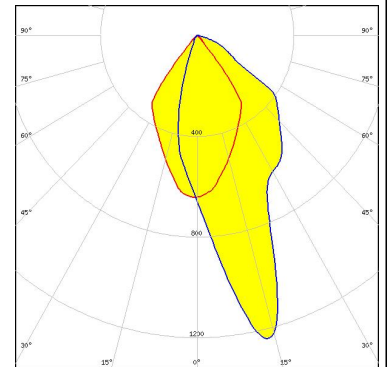

#### CITIZEN

LED CLU710/711  
 FWHM Asymmetric  
 Efficiency 84 %  
 Peak intensity 1 cd/lm  
 LEDs/each optic 1  
 Light colour White  
 Required components:  
 C12691\_LENA-STD-BASE-CLL030  
 C11996\_LENA-LENS

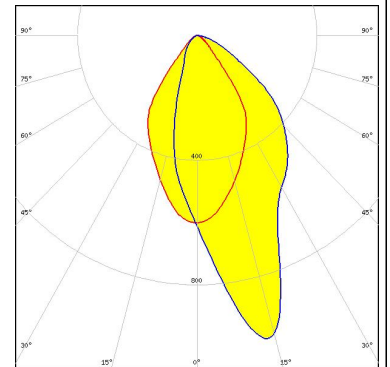

#### PHOTOMETRIC DATA (MEASURED):

#### CITIZEN

LED CLU720/721  
 FWHM Asymmetric  
 Efficiency 85 %  
 Peak intensity 0.9 cd/lm  
 LEDs/each optic 1  
 Light colour White  
 Required components:  
 C13868\_LENA-STD-BASE-VERO13-18  
 C11996\_LENA-LENS  
 Bender Wirth: 433 Typ L1

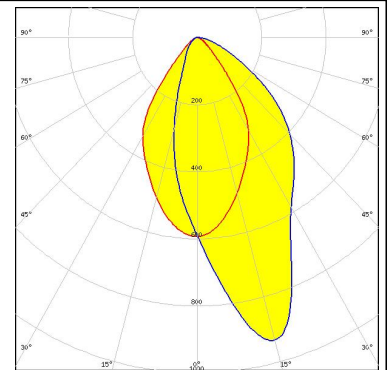

#### CITIZEN

LED CLU720/721  
 FWHM Asymmetric  
 Efficiency 90 %  
 Peak intensity 1.2 cd/lm  
 LEDs/each optic 1  
 Light colour White  
 Required components:  
 C13868\_LENA-STD-BASE-VERO13-18  
 Bender Wirth: 433 Typ L1

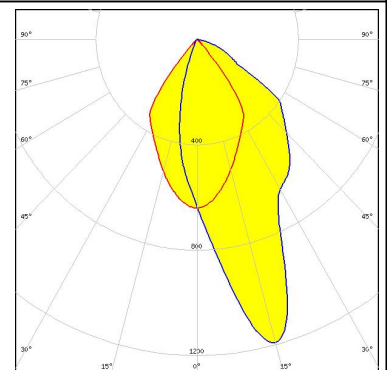
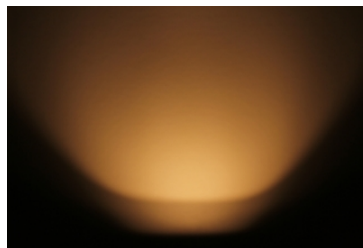

#### CITIZEN

LED CLU720/721  
 FWHM Asymmetric  
 Efficiency 86 %  
 Peak intensity 0.5 cd/lm  
 LEDs/each optic 1  
 Light colour White  
 Required components:  
 C13868\_LENA-STD-BASE-VERO13-18  
 C11996\_LENA-LENS  
 Bender Wirth: 433 Typ L1

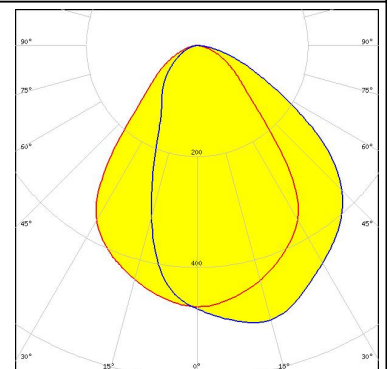
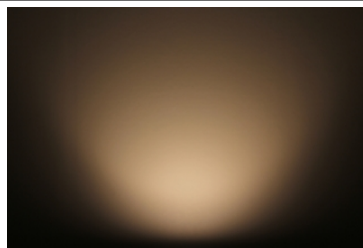

#### CITIZEN

LED CLU720/721  
 FWHM Asymmetric  
 Efficiency 90 %  
 Peak intensity 1.2 cd/lm  
 LEDs/each optic 1  
 Light colour White  
 Required components:  
 C13867\_LENA-STD-BASE-VERO29  
 Bender Wirth: 433 Typ L1

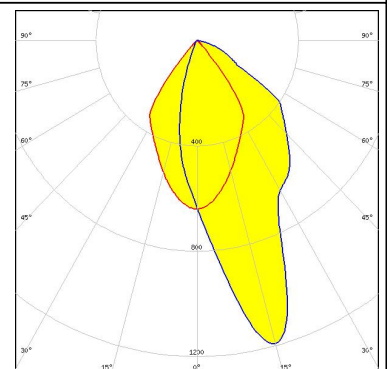
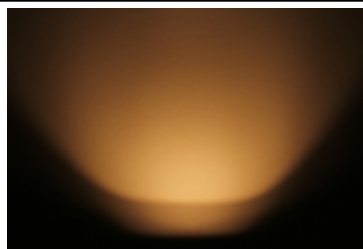

#### PHOTOMETRIC DATA (MEASURED):

**CREE** 

LED CMA1840  
 FWHM Asymmetric  
 Efficiency 86 %  
 Peak intensity 1.2 cd/lm  
 LEDs/each optic 1  
 Light colour White  
 Required components:  
 C14146\_LENA-STD-BASE-CXA18

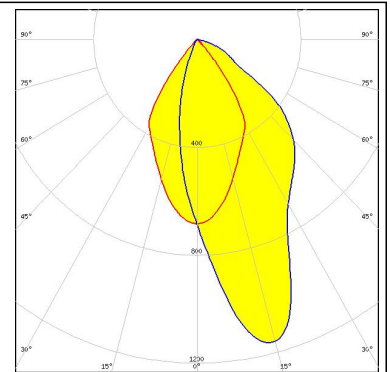

**CREE** 

LED CMA2550  
 FWHM Asymmetric  
 Efficiency 86 %  
 Peak intensity 1 cd/lm  
 LEDs/each optic 1  
 Light colour White  
 Required components:  
 C13324\_LENA-STD-BASE-CXA25

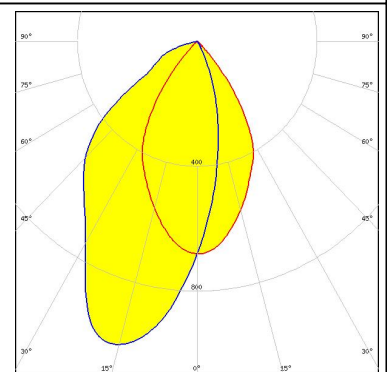
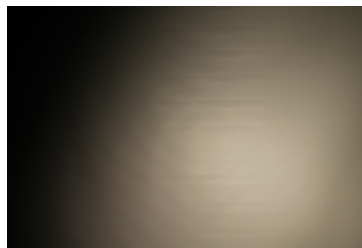

**CREE** 

LED CMT14xx  
 FWHM Asymmetric  
 Efficiency 85 %  
 Peak intensity 1.3 cd/lm  
 LEDs/each optic 1  
 Light colour White  
 Required components:  
 C13868\_LENA-STD-BASE-VERO13-18  
 Bender Wirth: 434 Typ L1

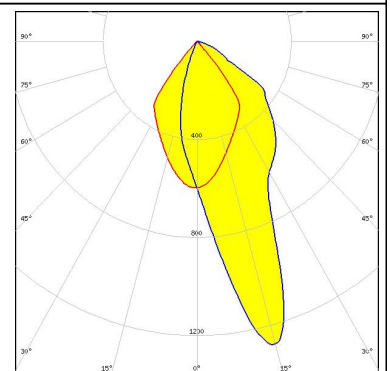

**CREE** 

LED CMT19xx  
 FWHM Asymmetric  
 Efficiency 86 %  
 Peak intensity 1.1 cd/lm  
 LEDs/each optic 1  
 Light colour White  
 Required components:  
 C12691\_LENA-STD-BASE-CLL030

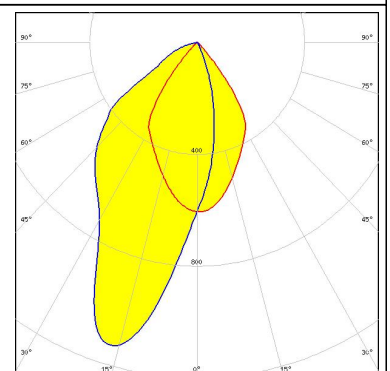
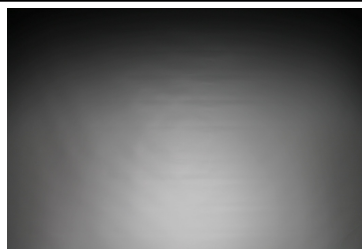

#### PHOTOMETRIC DATA (MEASURED):



LED CMT19xx  
 FWHM Asymmetric  
 Efficiency 86 %  
 Peak intensity 1.2 cd/lm  
 LEDs/each optic 1  
 Light colour White  
 Required components:  
 C13868\_LENA-STD-BASE-VERO13-18  
 Bender Wirth: 477 Typ L1

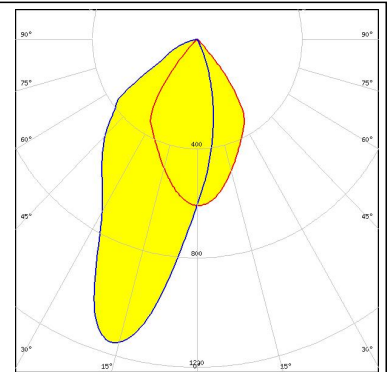
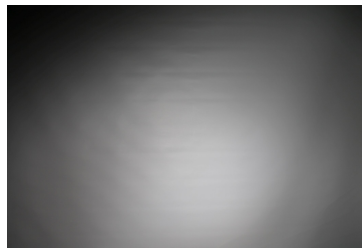

LED CMT28xx  
 FWHM Asymmetric  
 Efficiency 85 %  
 Peak intensity 0.9 cd/lm  
 LEDs/each optic 1  
 Light colour White  
 Required components:  
 C13867\_LENA-STD-BASE-VERO29  
 Bender Wirth: 471 Typ L3

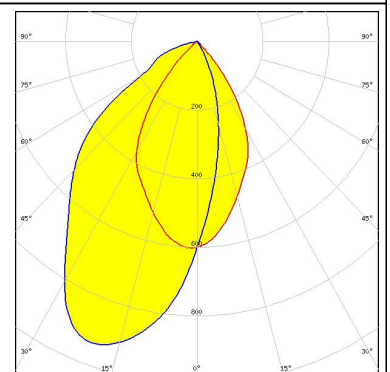
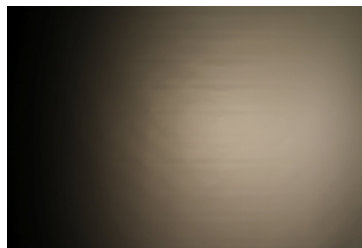

LED CMT28xx  
 FWHM Asymmetric  
 Efficiency 85 %  
 Peak intensity 1 cd/lm  
 LEDs/each optic 1  
 Light colour White  
 Required components:  
 C12692\_LENA-STD-BASE-CLL040

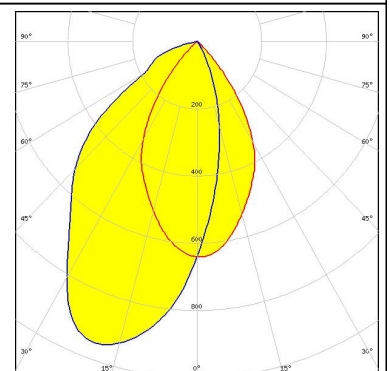
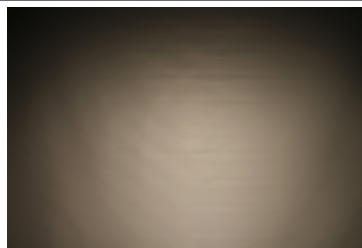

LED CXA/B 15xx  
 FWHM Asymmetric  
 Efficiency 89 %  
 Peak intensity 1.3 cd/lm  
 LEDs/each optic 1  
 Light colour White  
 Required components:  
 C13868\_LENA-STD-BASE-VERO13-18  
 Bender Wirth: 441 Typ L1

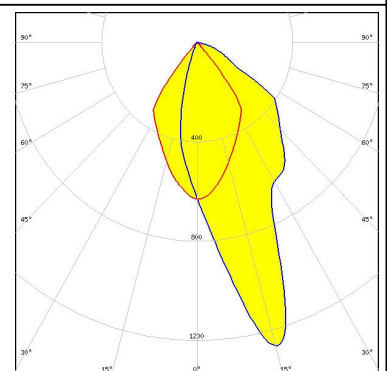
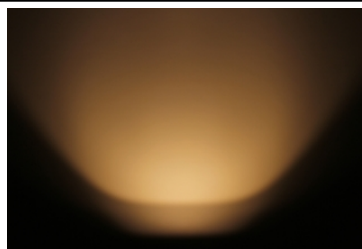



#### PHOTOMETRIC DATA (MEASURED):



LED CXA/B 15xx  
 FWHM Asymmetric  
 Efficiency 86 %  
 Peak intensity 0.5 cd/lm  
 LEDs/each optic 1  
 Light colour White  
 Required components:  
 C13868\_LENA-STD-BASE-VERO13-18  
 C11996\_LENA-LENS  
 Bender Wirth: 441 Typ L1

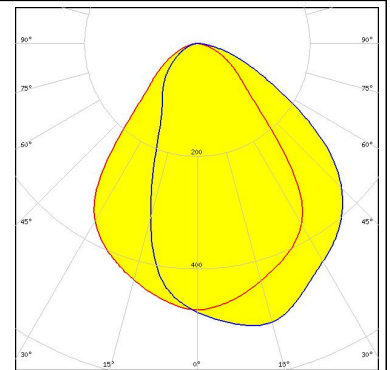

LED CXA/B 15xx  
 FWHM Asymmetric  
 Efficiency 84 %  
 Peak intensity 1.1 cd/lm  
 LEDs/each optic 1  
 Light colour White  
 Required components:  
 C13186\_LENA-STD-BASE-CXA15  
 C11996\_LENA-LENS

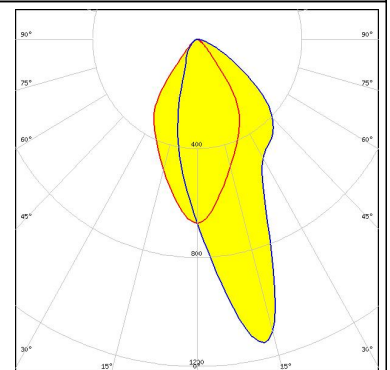

LED CXA/B 15xx  
 FWHM Asymmetric  
 Efficiency 85 %  
 Peak intensity 1 cd/lm  
 LEDs/each optic 1  
 Light colour White  
 Required components:  
 C13868\_LENA-STD-BASE-VERO13-18  
 C11996\_LENA-LENS  
 Bender Wirth: 441 Typ L1

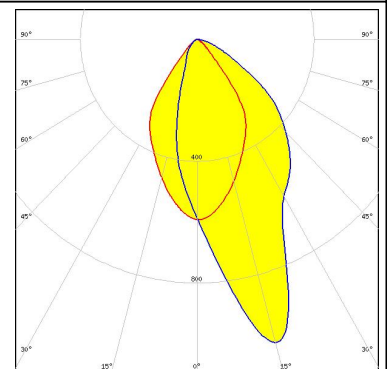
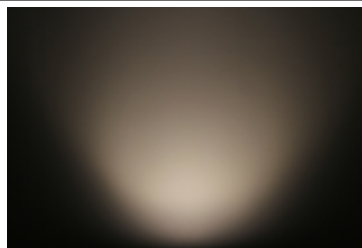

LED CXA/B 15xx  
 FWHM Asymmetric  
 Efficiency 88 %  
 Peak intensity 1.4 cd/lm  
 LEDs/each optic 1  
 Light colour White  
 Required components:  
 C13186\_LENA-STD-BASE-CXA15

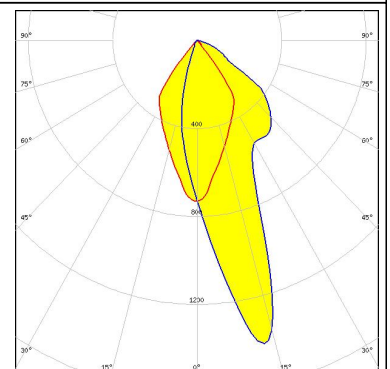

#### PHOTOMETRIC DATA (MEASURED):

**CREE** 

LED CXA/B 1816 & CXA/B 1820 & CXA 1850  
 FWHM Asymmetric  
 Efficiency 88 %  
 Peak intensity 1.1 cd/lm  
 LEDs/each optic 1  
 Light colour White  
 Required components:  
 C14146\_LENA-STD-BASE-CXA18

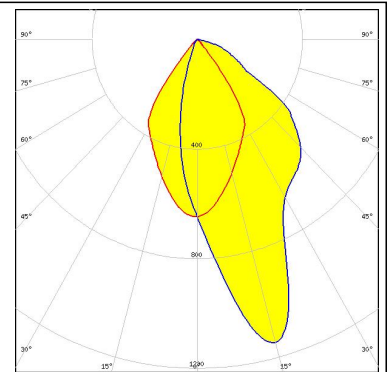
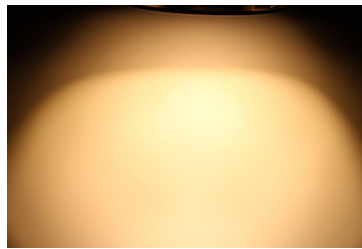

**CREE** 

LED CXA/B 1816 & CXA/B 1820 & CXA 1850  
 FWHM Asymmetric  
 Efficiency 84 %  
 Peak intensity 0.9 cd/lm  
 LEDs/each optic 1  
 Light colour White  
 Required components:  
 C13868\_LENA-STD-BASE-VERO13-18  
 C11996\_LENA-LENS  
 Bender Wirth: 437 Typ L1

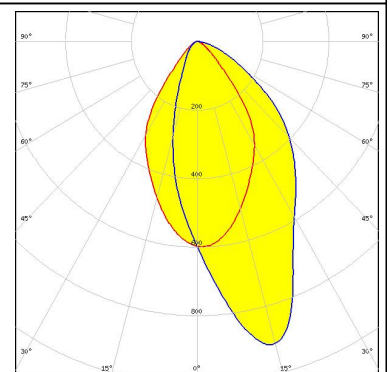
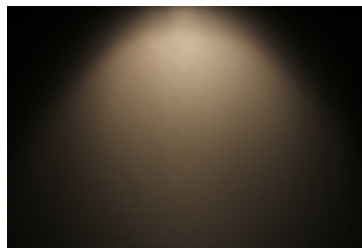

**CREE** 

LED CXA/B 1816 & CXA/B 1820 & CXA 1850  
 FWHM Asymmetric  
 Efficiency 87 %  
 Peak intensity 1.2 cd/lm  
 LEDs/each optic 1  
 Light colour White  
 Required components:  
 C13868\_LENA-STD-BASE-VERO13-18  
 Bender Wirth: 437 Typ L1

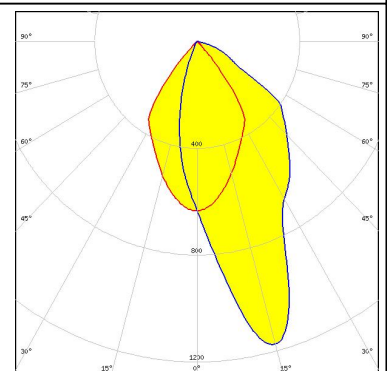
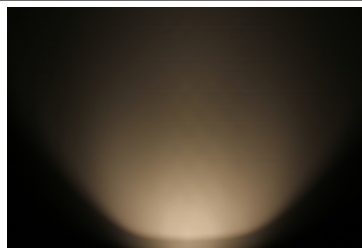

**CREE** 

LED CXA/B 1816 & CXA/B 1820 & CXA 1850  
 FWHM Asymmetric  
 Efficiency 86 %  
 Peak intensity 0.5 cd/lm  
 LEDs/each optic 1  
 Light colour White  
 Required components:  
 C13868\_LENA-STD-BASE-VERO13-18  
 C11996\_LENA-LENS  
 Bender Wirth: 437 Typ L1

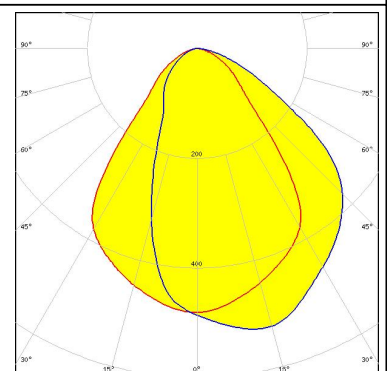
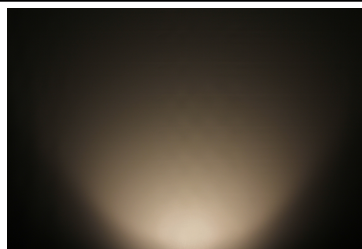

#### PHOTOMETRIC DATA (MEASURED):

#### CREE

LED CXA/B 25xx  
 FWHM Asymmetric  
 Efficiency 75 %  
 Peak intensity 0.9 cd/lm  
 LEDs/each optic 1  
 Light colour White  
 Required components:  
 C13324\_LENA-STD-BASE-CXA25

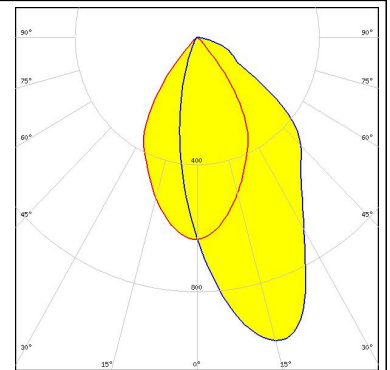

#### CREE

LED CXA2011  
 FWHM Asymmetric  
 Efficiency 79 %  
 Peak intensity 1 cd/lm  
 LEDs/each optic 1  
 Light colour White  
 Required components:  
 C12105\_LENA-STD-BASE-CXA20

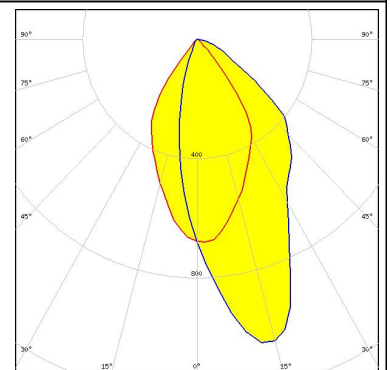

#### CREE

LED CXA2011  
 FWHM Asymmetric  
 Efficiency 75 %  
 Peak intensity 0.9 cd/lm  
 LEDs/each optic 1  
 Light colour White  
 Required components:  
 C12105\_LENA-STD-BASE-CXA20  
 C11996\_LENA-LENS

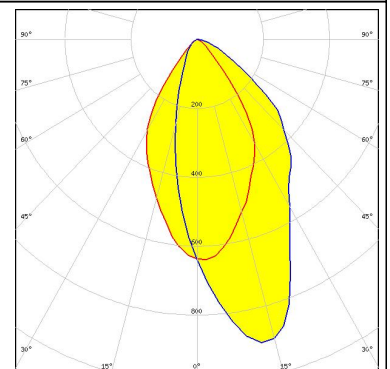

#### LUMILEDS

LED LUXEON CoB 1202/1203  
 FWHM Asymmetric  
 Efficiency 86 %  
 Peak intensity 0.5 cd/lm  
 LEDs/each optic 1  
 Light colour White  
 Required components:  
 C13868\_LENA-STD-BASE-VERO13-18  
 C11996\_LENA-LENS  
 Bender Wirth: 438 Typ L1

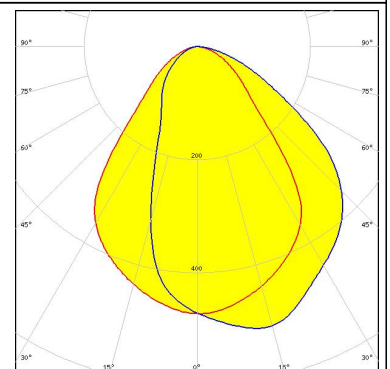
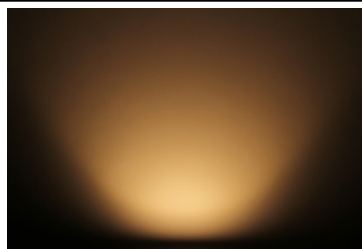

#### PHOTOMETRIC DATA (MEASURED):

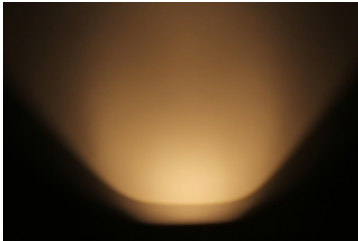
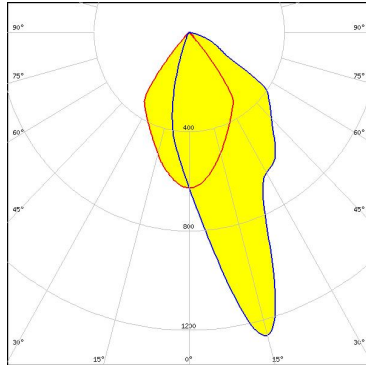
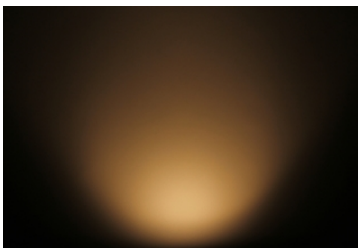
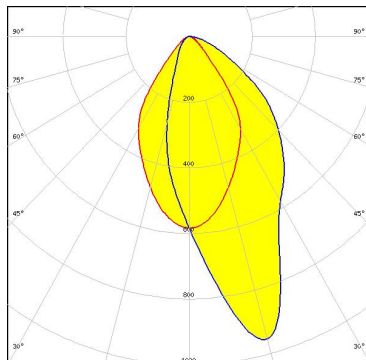
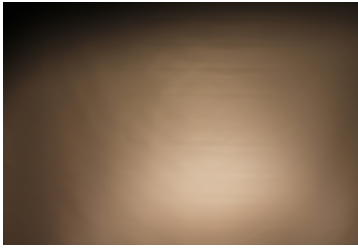
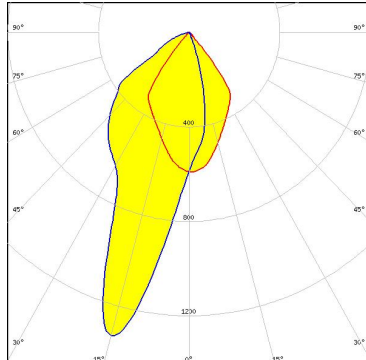
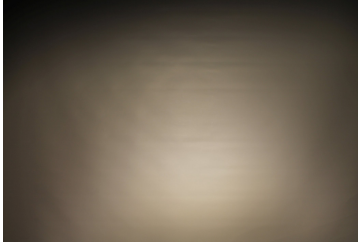
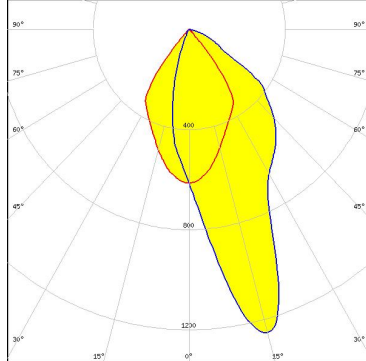
<p><b>LUMILEDS</b></p> <p>LED LUXEON CoB 1202/1203            FWHM Asymmetric            Efficiency 89 %            Peak intensity 1.3 cd/lm            LEDs/each optic 1            Light colour White            Required components:            C13868_LENA-STD-BASE-VERO13-18            Bender Wirth: 438 Typ L1</p>		
<p><b>LUMILEDS</b></p> <p>LED LUXEON CoB 1202/1203            FWHM Asymmetric            Efficiency 84 %            Peak intensity 1 cd/lm            LEDs/each optic 1            Light colour White            Required components:            C13868_LENA-STD-BASE-VERO13-18            C11996_LENA-LENS            Bender Wirth: 438 Typ L1</p>		
<p><b>LUMILEDS</b></p> <p>LED LUXEON CoB 1204HD            FWHM Asymmetric            Efficiency 86 %            Peak intensity 1.3 cd/lm            LEDs/each optic 1            Light colour White            Required components:            C11981_LENA-STD-BASE-COB-L110</p>		
<p><b>LUMILEDS</b></p> <p>LED LUXEON CoB 1205HD            FWHM Asymmetric            Efficiency 86 %            Peak intensity 1.3 cd/lm            LEDs/each optic 1            Light colour White            Required components:            C11981_LENA-STD-BASE-COB-L110</p>		



#### PHOTOMETRIC DATA (MEASURED):

##### LUMILEDS

LED LUXEON CoB 1211  
 FWHM Asymmetric  
 Efficiency 89 %  
 Peak intensity 1 cd/lm  
 LEDs/each optic 1  
 Light colour White  
 Required components:  
 C13867\_LENA-STD-BASE-VERO29  
 Bender Wirth: 431 Typ L3

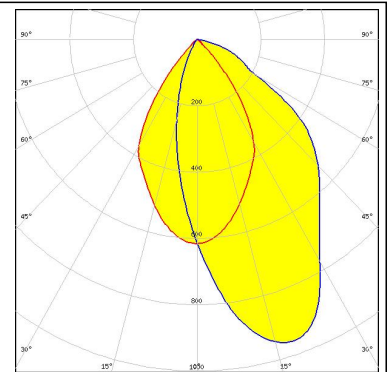
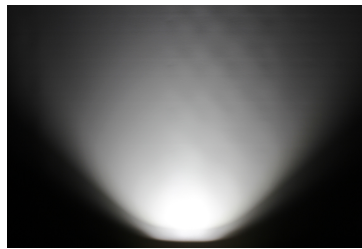

##### LUMILEDS

LED LUXEON CoB 1211  
 FWHM Asymmetric  
 Efficiency 84 %  
 Peak intensity 0.8 cd/lm  
 LEDs/each optic 1  
 Light colour White  
 Required components:  
 C13867\_LENA-STD-BASE-VERO29  
 C11996\_LENA-LENS  
 Bender Wirth: 431 Typ L3

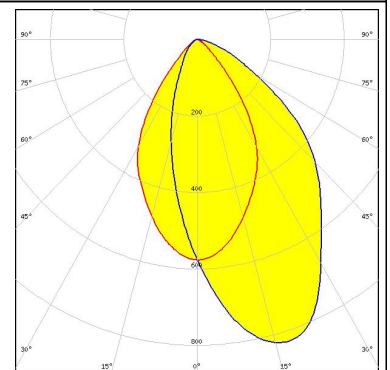
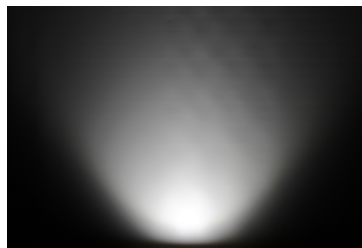

##### LUMILEDS

LED LUXEON CoB 1216/1812  
 FWHM Asymmetric  
 Efficiency 88 %  
 Peak intensity 0.9 cd/lm  
 LEDs/each optic 1  
 Light colour White  
 Required components:  
 C12692\_LENA-STD-BASE-CLL040

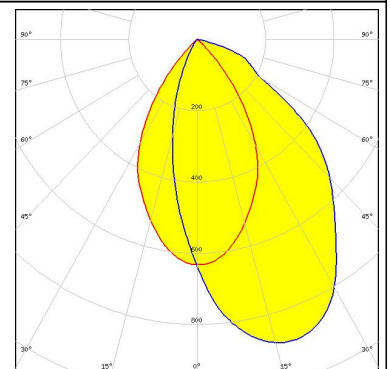
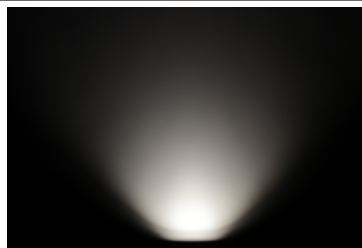

##### LUMILEDS

LED LUXEON CoB 1216/1812  
 FWHM Asymmetric  
 Efficiency 84 %  
 Peak intensity 0.8 cd/lm  
 LEDs/each optic 1  
 Light colour White  
 Required components:  
 C12692\_LENA-STD-BASE-CLL040  
 C11996\_LENA-LENS

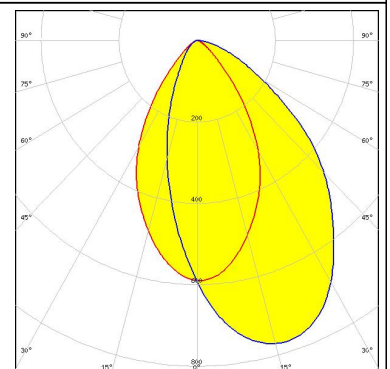
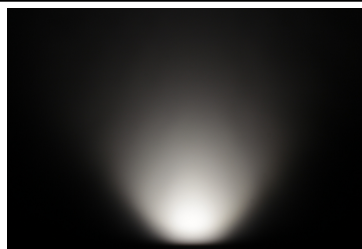

#### PHOTOMETRIC DATA (MEASURED):

##### LUMILEDS

LED LUXEON CoB 1216/1812  
 FWHM 60.0°  
 Efficiency 81 %  
 Peak intensity 0.8 cd/lm  
 LEDs/each optic 1  
 Light colour White  
 Required components:  
 A.A.G. STUCCHI: 8102/G2 + S-8000/12

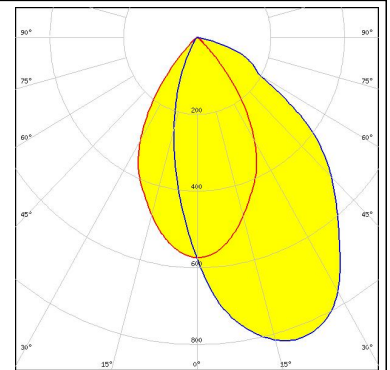
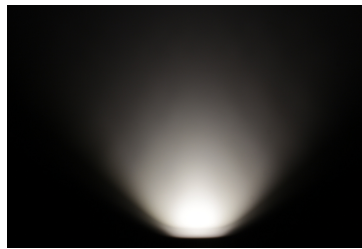

##### LUMILEDS

LED LUXEON CoB 1216/1812  
 FWHM Asymmetric  
 Efficiency 77 %  
 Peak intensity 0.7 cd/lm  
 LEDs/each optic 1  
 Light colour White  
 Required components:  
 C11996\_LENA-LENS  
 A.A.G. STUCCHI: 8102/G2 + S-8000/12

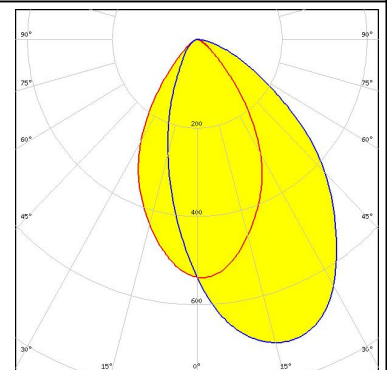
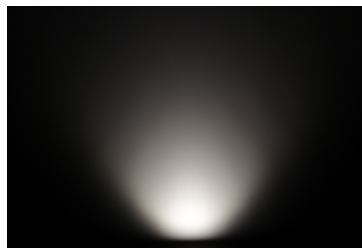

##### LUMILEDS

LED LUXEON K12  
 FWHM Asymmetric  
 Efficiency 77 %  
 Peak intensity 1.1 cd/lm  
 LEDs/each optic 1  
 Light colour White  
 Required components:  
 C12924\_LENA-STD-BASE-LUXEON-K  
 C11996\_LENA-LENS

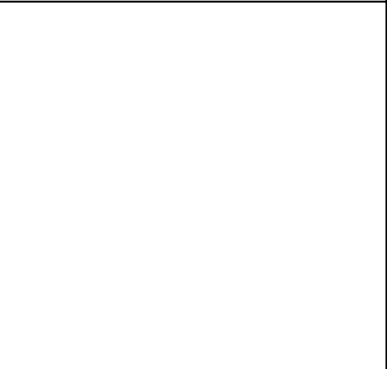
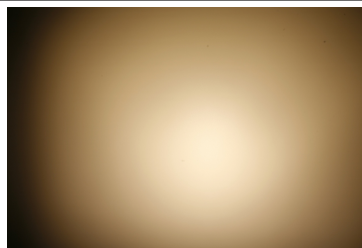

##### LUMILEDS

LED LUXEON K12  
 FWHM Asymmetric  
 Efficiency 82 %  
 Peak intensity 1.3 cd/lm  
 LEDs/each optic 1  
 Light colour White  
 Required components:  
 C12924\_LENA-STD-BASE-LUXEON-K

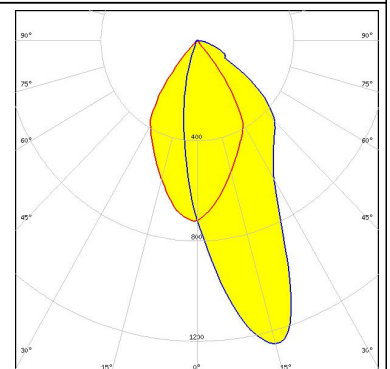
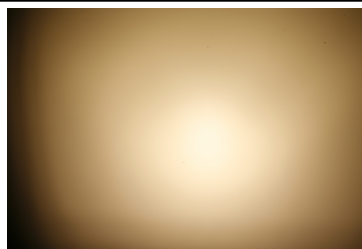

#### PHOTOMETRIC DATA (MEASURED):

#### LUMILEDS

LED LUXEON K16  
 FWHM Asymmetric  
 Efficiency 76 %  
 Peak intensity 1 cd/lm  
 LEDs/each optic 1  
 Light colour White  
 Required components:  
 C12924\_LENA-STD-BASE-LUXEON-K  
 C11996\_LENA-LENS



#### LUMILEDS

LED LUXEON K16  
 FWHM Asymmetric  
 Efficiency 81 %  
 Peak intensity 1.1 cd/lm  
 LEDs/each optic 1  
 Light colour White  
 Required components:  
 C12924\_LENA-STD-BASE-LUXEON-K

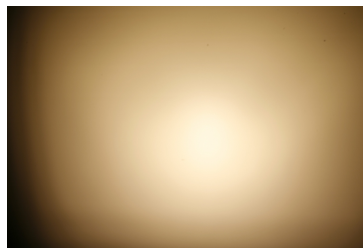

#### LUMINUS

LED CDM-14 (Dim-To-Warm)  
 FWHM Asymmetric  
 Efficiency 83 %  
 Peak intensity 0.9 cd/lm  
 LEDs/each optic 1  
 Light colour White  
 Required components:  
 C13868\_LENA-STD-BASE-VERO13-18  
 C11996\_LENA-LENS  
 Bender Wirth: 491 Typ L2

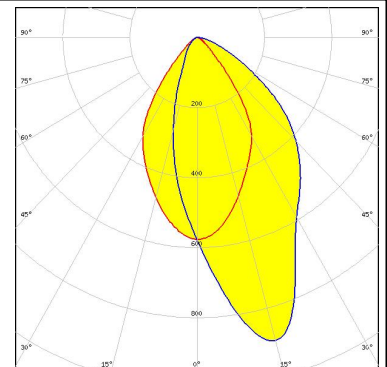
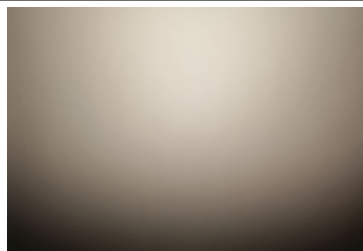

#### LUMINUS

LED CDM-14 (Dim-To-Warm)  
 FWHM 59.0°  
 Efficiency 88 %  
 Peak intensity 1.1 cd/lm  
 LEDs/each optic 1  
 Light colour White  
 Required components:  
 C13868\_LENA-STD-BASE-VERO13-18  
 Bender Wirth: 491 Typ L2

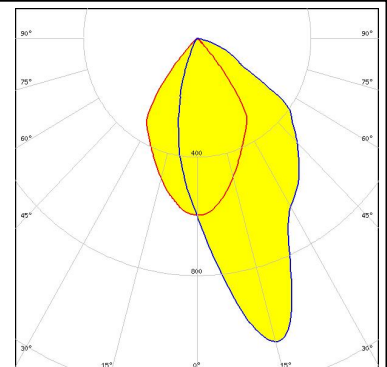
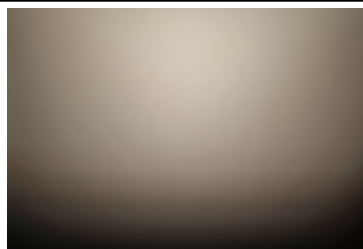

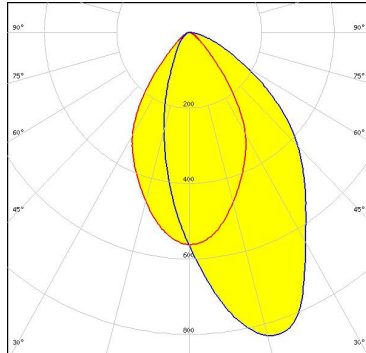
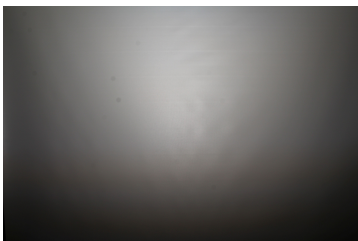
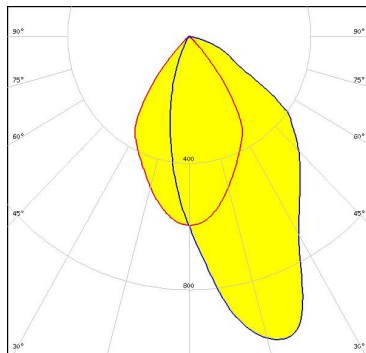
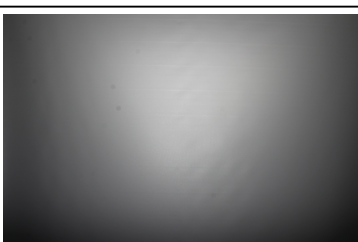
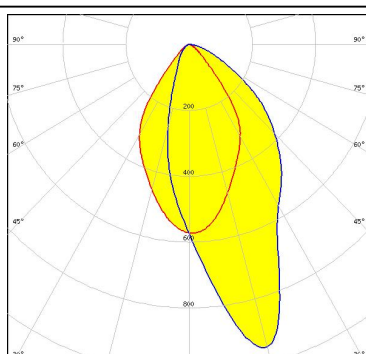
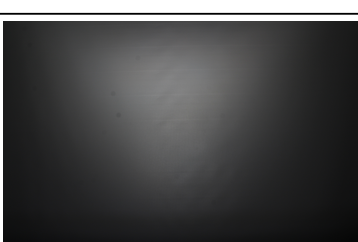
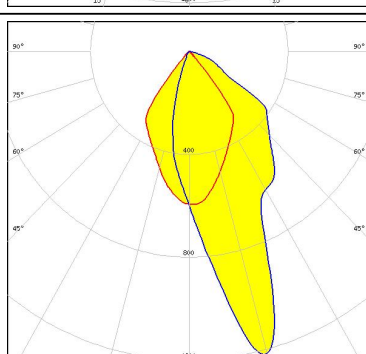

#### PHOTOMETRIC DATA (MEASURED):

<p><b>LUMINUS</b></p> <p>LED CDM-18 (Dim-To-Warm)            FWHM Asymmetric            Efficiency 83 %            Peak intensity 0.8 cd/lm            LEDs/each optic 1            Light colour White</p> <p>Required components:            C13868_LENA-STD-BASE-VERO13-18            C11996_LENA-LENS            Bender Wirth: 491 Typ L2</p>		
<p><b>LUMINUS</b></p> <p>LED CDM-18 (Dim-To-Warm)            FWHM Asymmetric            Efficiency 88 %            Peak intensity 1 cd/lm            LEDs/each optic 1            Light colour White</p> <p>Required components:            C13868_LENA-STD-BASE-VERO13-18            Bender Wirth: 491 Typ L2</p>		
<p><b>LUMINUS</b></p> <p>LED CDM-9 (Dim-To-Warm)            FWHM Asymmetric            Efficiency 83 %            Peak intensity 1 cd/lm            LEDs/each optic 1            Light colour White</p> <p>Required components:            C13868_LENA-STD-BASE-VERO13-18            C11996_LENA-LENS            Bender Wirth: 490 Typ L1</p>		
<p><b>LUMINUS</b></p> <p>LED CDM-9 (Dim-To-Warm)            FWHM Asymmetric            Efficiency 88 %            Peak intensity 1.2 cd/lm            LEDs/each optic 1            Light colour White</p> <p>Required components:            C13868_LENA-STD-BASE-VERO13-18            Bender Wirth: 490 Typ L1</p>		

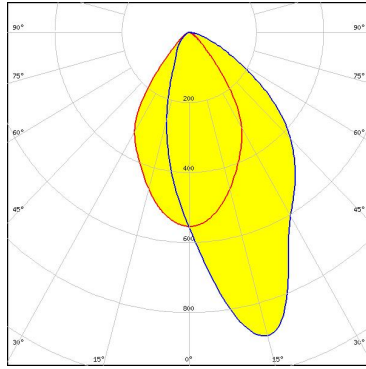
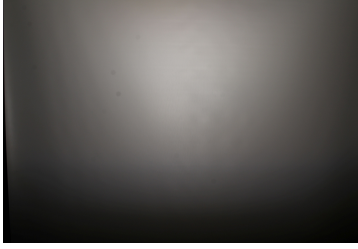
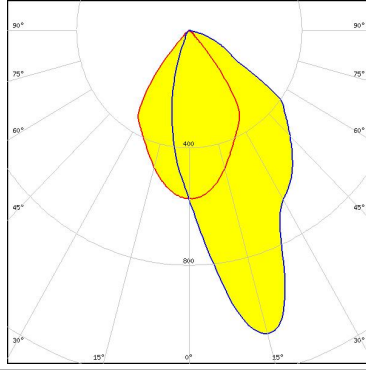

#### PHOTOMETRIC DATA (MEASURED):

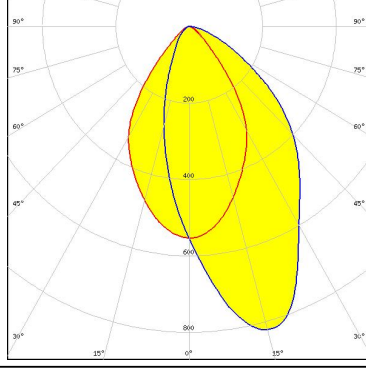
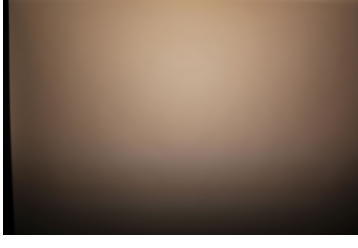
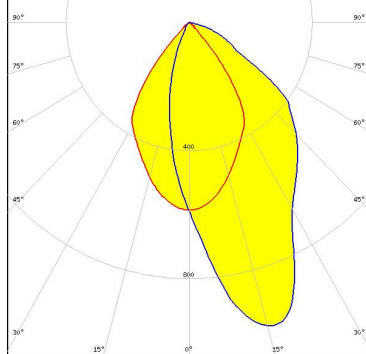
<p><b>LUMINUS</b></p> <p>LED CTM-14 (Tunable White)            FWHM Asymmetric            Efficiency 87 %            Peak intensity 1.1 cd/lm            LEDs/each optic 1            Light colour White</p> <p>Required components:            C13867_LENA-STD-BASE-VERO29            C12606_LENINA-DL            Bender Wirth: 442 Typ L3</p>		
<p><b>LUMINUS</b></p> <p>LED CTM-14 (Tunable White)            FWHM Asymmetric            Efficiency 87 %            Peak intensity 1.1 cd/lm            LEDs/each optic 1            Light colour White</p> <p>Required components:            C13867_LENA-STD-BASE-VERO29            Bender Wirth: 442 Typ L3</p>		
<p><b>LUMINUS</b></p> <p>LED CTM-18 (Tunable White)            FWHM Asymmetric            Efficiency 82 %            Peak intensity 0.8 cd/lm            LEDs/each optic 1            Light colour White</p> <p>Required components:            C13867_LENA-STD-BASE-VERO29            C11996_LENA-LENS            Bender Wirth: 442 Typ L3</p>		
<p><b>LUMINUS</b></p> <p>LED CTM-18 (Tunable White)            FWHM Asymmetric            Efficiency 88 %            Peak intensity 1 cd/lm            LEDs/each optic 1            Light colour White</p> <p>Required components:            C13867_LENA-STD-BASE-VERO29            Bender Wirth: 442 Typ L3</p>		

#### PHOTOMETRIC DATA (MEASURED):



LED CTM-22 (Tunable White)  
 FWHM Asymmetric  
 Efficiency 83 %  
 Peak intensity 0.8 cd/lm  
 LEDs/each optic 1  
 Light colour White  
 Required components:  
 C13867\_LENA-STD-BASE-VERO29  
 C11996\_LENA-LENS  
 Bender Wirth: 494 Typ L3

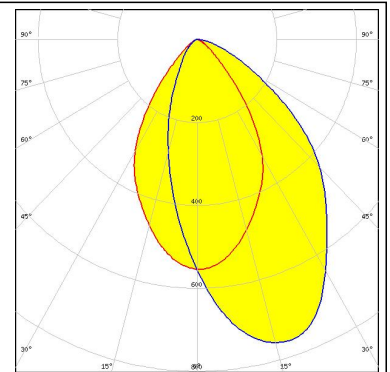
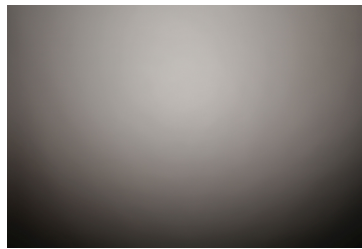

LED CTM-22 (Tunable White)  
 FWHM Asymmetric  
 Efficiency 87 %  
 Peak intensity 0.9 cd/lm  
 LEDs/each optic 1  
 Light colour White  
 Required components:  
 C13867\_LENA-STD-BASE-VERO29  
 Bender Wirth: 494 Typ L3

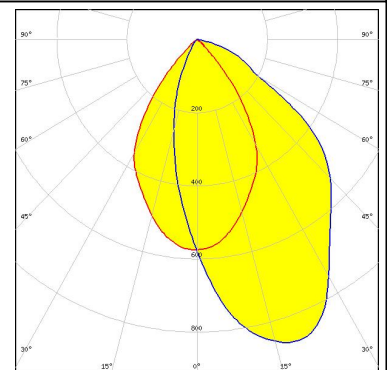
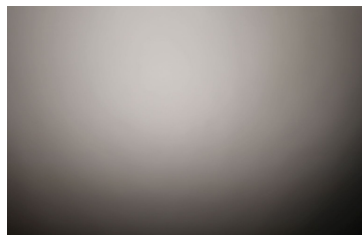

LED CxM-14 (19x19)  
 FWHM Asymmetric  
 Efficiency 87 %  
 Peak intensity 1.1 cd/lm  
 LEDs/each optic 1  
 Light colour White  
 Required components:  
 C12691\_LENA-STD-BASE-CLL030

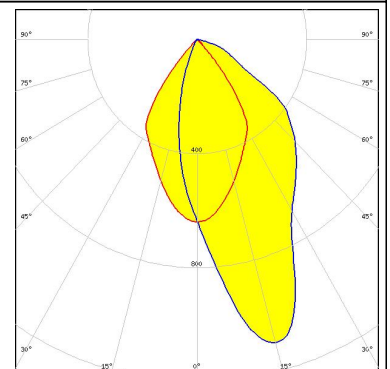
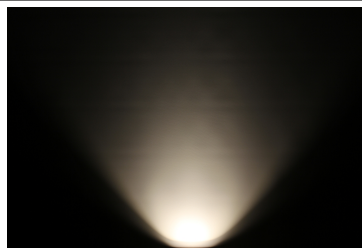

LED CxM-14 (19x19)  
 FWHM Asymmetric  
 Efficiency 82 %  
 Peak intensity 0.9 cd/lm  
 LEDs/each optic 1  
 Light colour White  
 Required components:  
 C12691\_LENA-STD-BASE-CLL030  
 C11996\_LENA-LENS

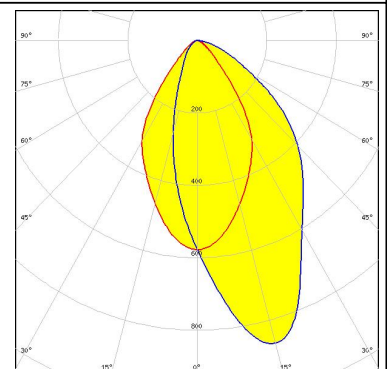
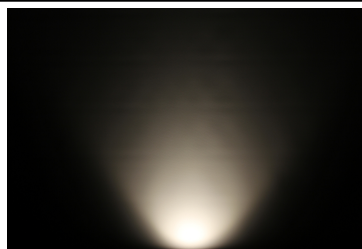

#### PHOTOMETRIC DATA (MEASURED):



LED CxM-22 (28x28)  
 FWHM Asymmetric  
 Efficiency 84 %  
 Peak intensity 0.9 cd/lm  
 LEDs/each optic 1  
 Light colour White  
 Required components:  
 C12692\_LENA-STD-BASE-CLL040

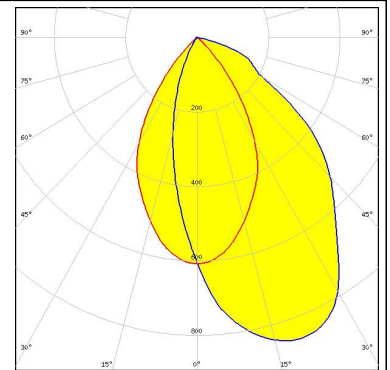
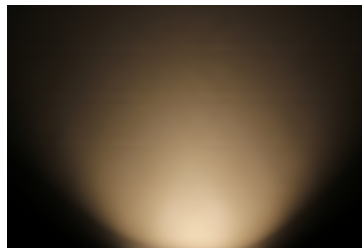

LED CxM-22 (28x28)  
 FWHM Asymmetric  
 Efficiency 79 %  
 Peak intensity 0.7 cd/lm  
 LEDs/each optic 1  
 Light colour White  
 Required components:  
 C12692\_LENA-STD-BASE-CLL040  
 C11996\_LENA-LENS

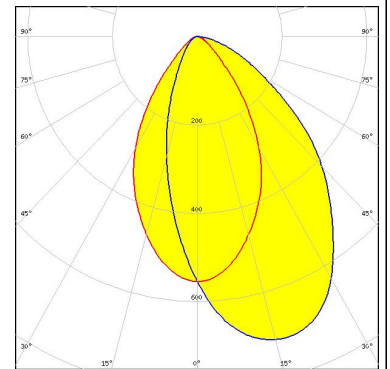
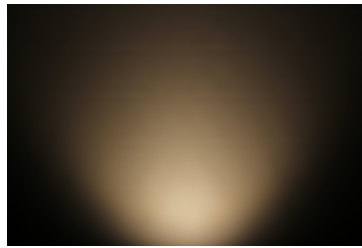

LED COB J-Type  
 FWHM Asymmetric  
 Efficiency 86 %  
 Peak intensity 0.5 cd/lm  
 LEDs/each optic 1  
 Light colour White  
 Required components:  
 C13868\_LENA-STD-BASE-VERO13-18  
 C11996\_LENA-LENS  
 Bender Wirth: 463 Typ L2

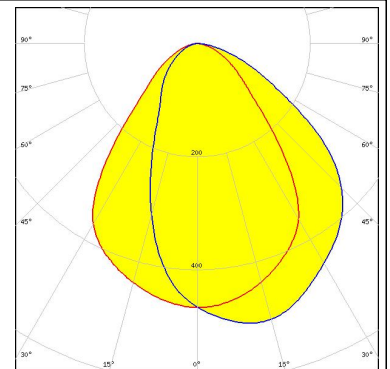

LED COB J-Type  
 FWHM Asymmetric  
 Efficiency 84 %  
 Peak intensity 0.9 cd/lm  
 LEDs/each optic 1  
 Light colour White  
 Required components:  
 C13868\_LENA-STD-BASE-VERO13-18  
 C11996\_LENA-LENS  
 Bender Wirth: 463 Typ L2

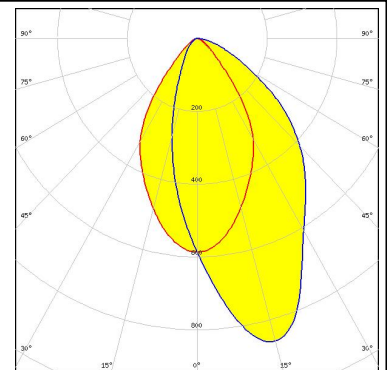
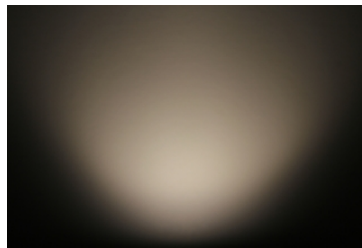

#### PHOTOMETRIC DATA (MEASURED):



LED COB J-Type  
 FWHM Asymmetric  
 Efficiency 89 %  
 Peak intensity 1.1 cd/lm  
 LEDs/each optic 1  
 Light colour White  
 Required components:  
 C13868\_LENA-STD-BASE-VERO13-18  
 Bender Wirth: 463 Typ L2

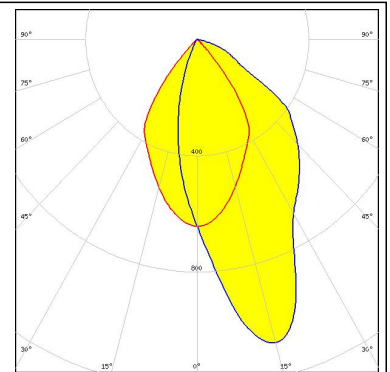
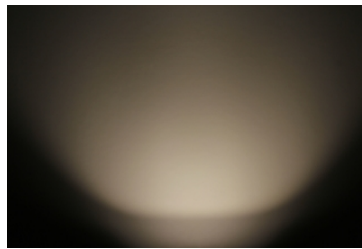

LED COB L-Type (LES 11)  
 FWHM Asymmetric  
 Efficiency 86 %  
 Peak intensity 0.5 cd/lm  
 LEDs/each optic 1  
 Light colour White  
 Required components:  
 C13868\_LENA-STD-BASE-VERO13-18  
 C11996\_LENA-LENS  
 Bender Wirth: 438 Typ L1

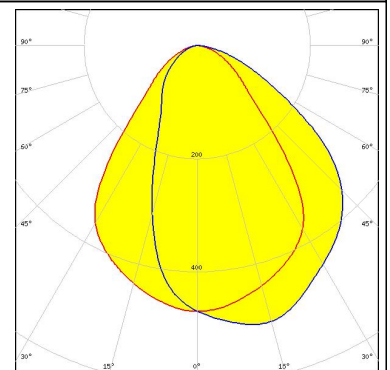
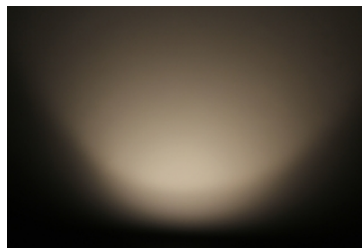

LED COB L-Type (LES 11)  
 FWHM Asymmetric  
 Efficiency 84 %  
 Peak intensity 0.9 cd/lm  
 LEDs/each optic 1  
 Light colour White  
 Required components:  
 C13868\_LENA-STD-BASE-VERO13-18  
 C11996\_LENA-LENS  
 Bender Wirth: 438 Typ L1

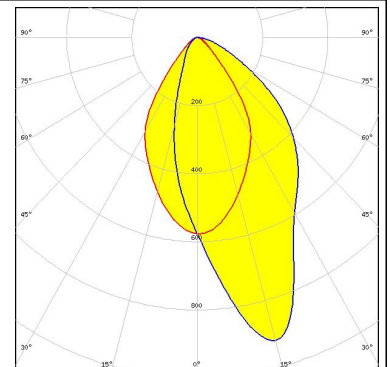

LED COB L-Type (LES 11)  
 FWHM Asymmetric  
 Efficiency 89 %  
 Peak intensity 1.2 cd/lm  
 LEDs/each optic 1  
 Light colour White  
 Required components:  
 C13868\_LENA-STD-BASE-VERO13-18  
 Bender Wirth: 438 Typ L1

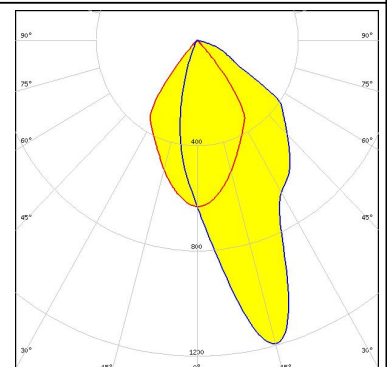
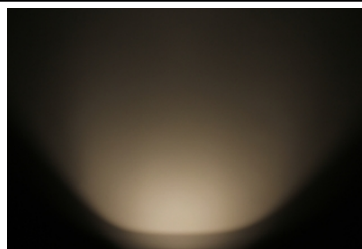



#### PHOTOMETRIC DATA (MEASURED):



LED COB L-Type (LES 9)  
 FWHM Asymmetric  
 Efficiency 85 %  
 Peak intensity 0.5 cd/lm  
 LEDs/each optic 1  
 Light colour White  
 Required components:  
 C13868\_LENA-STD-BASE-VERO13-18  
 C11996\_LENA-LENS  
 Bender Wirth: 438 Typ L1

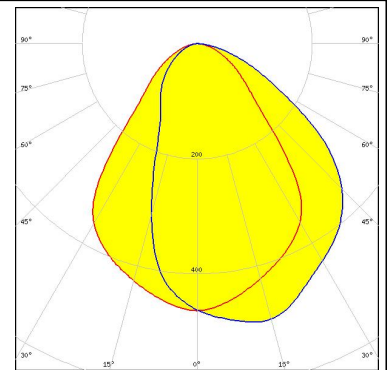
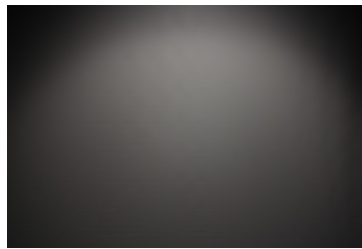

LED COB L-Type (LES 9)  
 FWHM Asymmetric  
 Efficiency 84 %  
 Peak intensity 0.9 cd/lm  
 LEDs/each optic 1  
 Light colour White  
 Required components:  
 C13868\_LENA-STD-BASE-VERO13-18  
 C11996\_LENA-LENS  
 Bender Wirth: 438 Typ L1

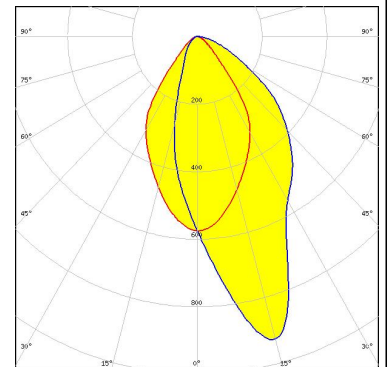
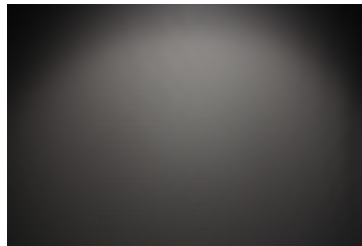

LED COB L-Type (LES 9)  
 FWHM Asymmetric  
 Efficiency 90 %  
 Peak intensity 1.3 cd/lm  
 LEDs/each optic 1  
 Light colour White  
 Required components:  
 C13868\_LENA-STD-BASE-VERO13-18  
 Bender Wirth: 438 Typ L1

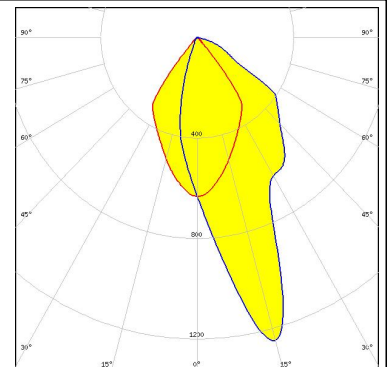
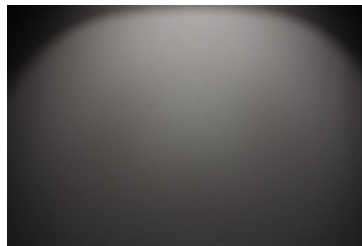

LED NVCWJ024Z-V1MT: COB J-Type Tunable White  
 FWHM Asymmetric  
 Efficiency 83 %  
 Peak intensity 0.9 cd/lm  
 LEDs/each optic 1  
 Light colour White  
 Required components:  
 C13868\_LENA-STD-BASE-VERO13-18  
 C11996\_LENA-LENS  
 Bender Wirth: 498 Typ L2

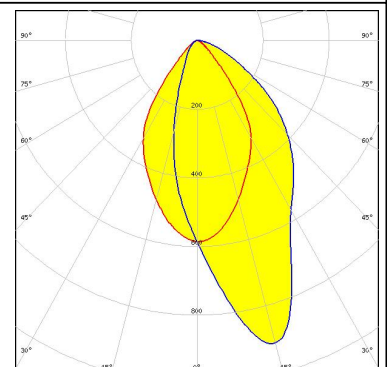
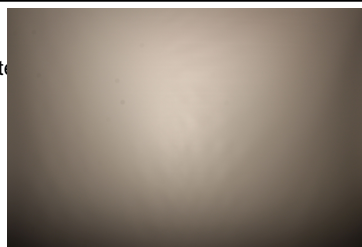

#### PHOTOMETRIC DATA (MEASURED):

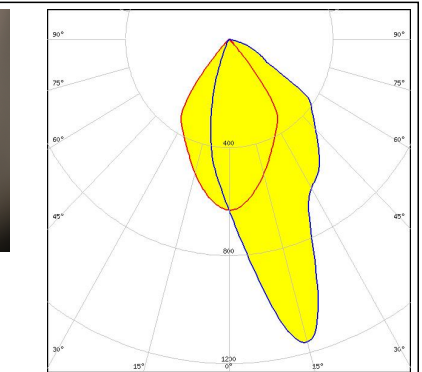
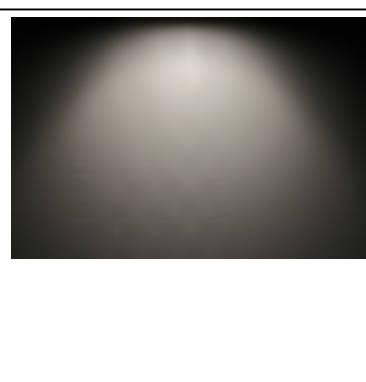
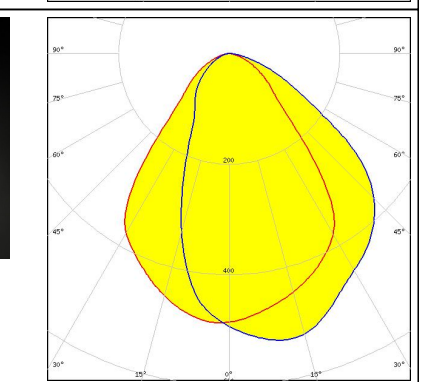
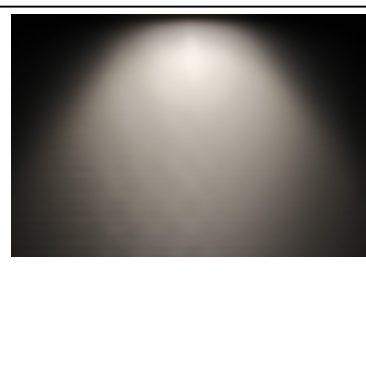
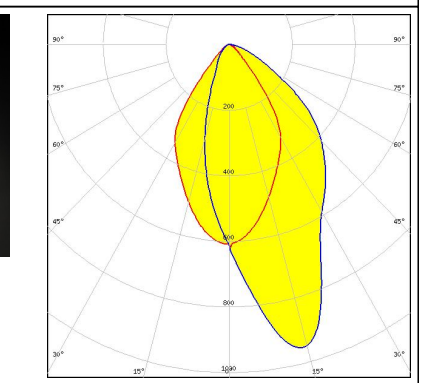
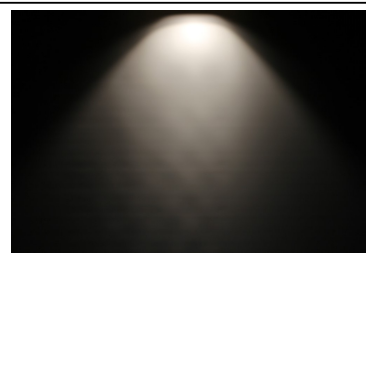
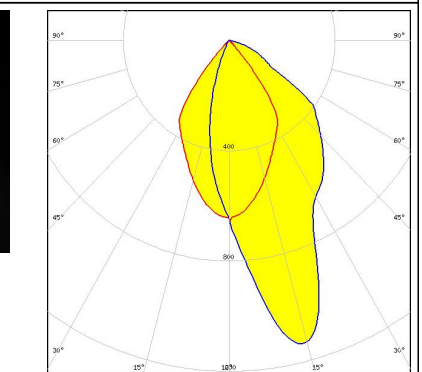
<p><b>NICHIA</b></p> <p>LED NVCWJ024Z-V1MT: COB J-Type Tunable White</p> <p>FWHM Asymmetric</p> <p>Efficiency 88 %</p> <p>Peak intensity 1.2 cd/lm</p> <p>LEDs/each optic 1</p> <p>Light colour White</p> <p>Required components: C13868_LENA-STD-BASE-VERO13-18 Bender Wirth: 498 Typ L2</p>		
<p><b>OSRAM</b> Opto Semiconductors</p> <p>LED Soleriq S13</p> <p>FWHM Asymmetric</p> <p>Efficiency 86 %</p> <p>Peak intensity 0.5 cd/lm</p> <p>LEDs/each optic 1</p> <p>Light colour White</p> <p>Required components: C13868_LENA-STD-BASE-VERO13-18 C11996_LENA-LENS Bender Wirth: 437 Typ L1</p>		
<p><b>OSRAM</b> Opto Semiconductors</p> <p>LED Soleriq S13</p> <p>FWHM Asymmetric</p> <p>Efficiency 84 %</p> <p>Peak intensity 1 cd/lm</p> <p>LEDs/each optic 1</p> <p>Light colour White</p> <p>Required components: C13868_LENA-STD-BASE-VERO13-18 C11996_LENA-LENS Bender Wirth: 437 Typ L1</p>		
<p><b>OSRAM</b> Opto Semiconductors</p> <p>LED Soleriq S13</p> <p>FWHM Asymmetric</p> <p>Efficiency 88 %</p> <p>Peak intensity 1.1 cd/lm</p> <p>LEDs/each optic 1</p> <p>Light colour White</p> <p>Required components: C13868_LENA-STD-BASE-VERO13-18 Bender Wirth: 437 Typ L1</p>		

#### PHOTOMETRIC DATA (MEASURED):

#### OSRAM

Opto Semiconductors

LED Soleriq S19  
 FWHM Asymmetric  
 Efficiency 89 %  
 Peak intensity 1 cd/lm  
 LEDs/each optic 1  
 Light colour White  
 Required components:  
 C13867\_LENA-STD-BASE-VERO29  
 Bender Wirth: 462 Typ L3

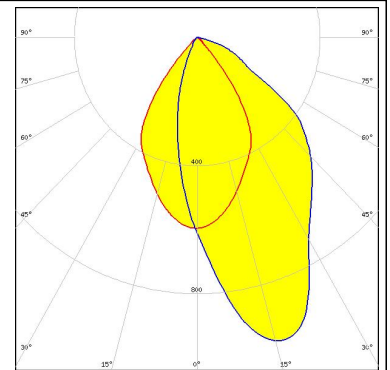
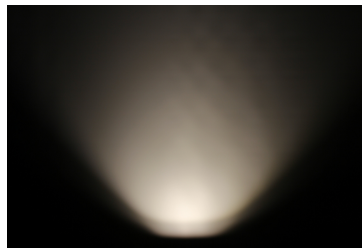

#### OSRAM

Opto Semiconductors

LED Soleriq S19  
 FWHM Asymmetric  
 Efficiency 84 %  
 Peak intensity 0.9 cd/lm  
 LEDs/each optic 1  
 Light colour White  
 Required components:  
 C13867\_LENA-STD-BASE-VERO29  
 C11996\_LENA-LENS  
 Bender Wirth: 462 Typ L3

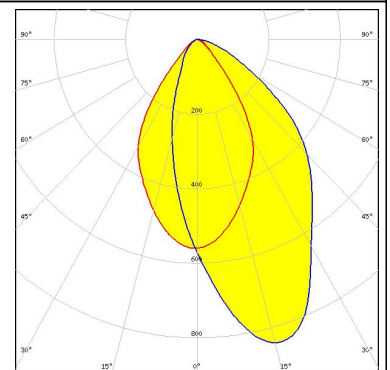
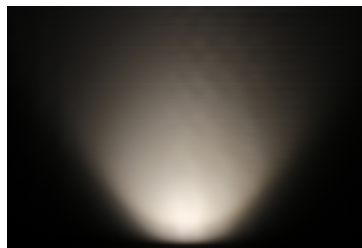

#### PHILIPS

LED Fortimo SLM L13 CoB  
 FWHM Asymmetric  
 Efficiency 80 %  
 Peak intensity 1 cd/lm  
 LEDs/each optic 1  
 Light colour White  
 Required components:  
 C12292\_LENA-STD-BASE-MEZ  
 C11996\_LENA-LENS

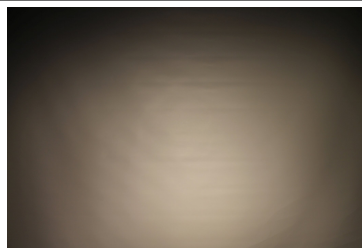

#### PHILIPS

LED Fortimo SLM L13 CoB  
 FWHM Asymmetric  
 Efficiency 85 %  
 Peak intensity 1.1 cd/lm  
 LEDs/each optic 1  
 Light colour White  
 Required components:  
 C12292\_LENA-STD-BASE-MEZ

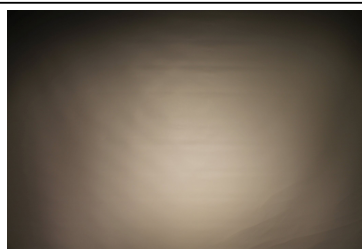

#### PHOTOMETRIC DATA (MEASURED):

#### PHILIPS

LED Fortimo SLM L15 CoB  
 FWHM Asymmetric  
 Efficiency 85 %  
 Peak intensity 1.1 cd/lm  
 LEDs/each optic 1  
 Light colour White  
 Required components:  
 C12292\_LENA-STD-BASE-MEZ

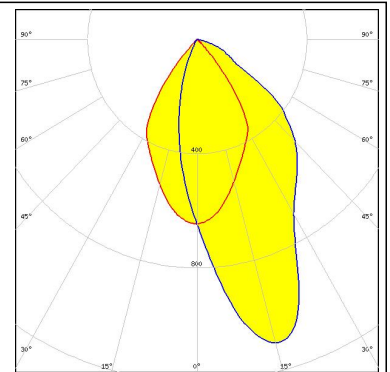

#### PHILIPS

LED Fortimo SLM L15 CoB  
 FWHM Asymmetric  
 Efficiency 80 %  
 Peak intensity 0.9 cd/lm  
 LEDs/each optic 1  
 Light colour White  
 Required components:  
 C12292\_LENA-STD-BASE-MEZ  
 C11996\_LENA-LENS

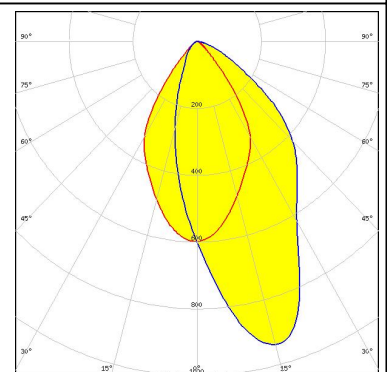
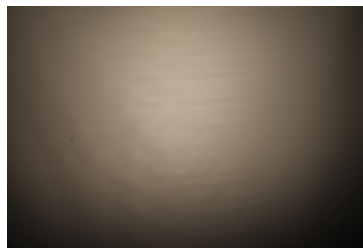

#### PHILIPS

LED Fortimo SLM L19 CoB  
 FWHM Asymmetric  
 Efficiency 85 %  
 Peak intensity 1 cd/lm  
 LEDs/each optic 1  
 Light colour White  
 Required components:  
 C12692\_LENA-STD-BASE-CLL040

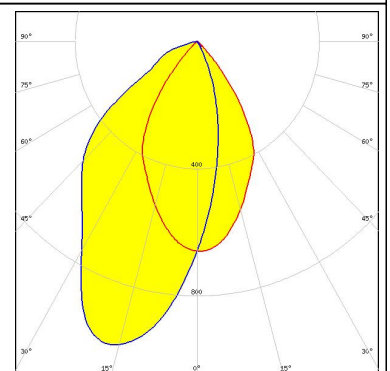
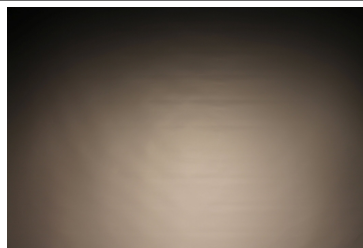

#### PHILIPS

LED Fortimo SLM L19 CoB  
 FWHM Asymmetric  
 Efficiency 80 %  
 Peak intensity 0.9 cd/lm  
 LEDs/each optic 1  
 Light colour White  
 Required components:  
 C12692\_LENA-STD-BASE-CLL040  
 C11996\_LENA-LENS

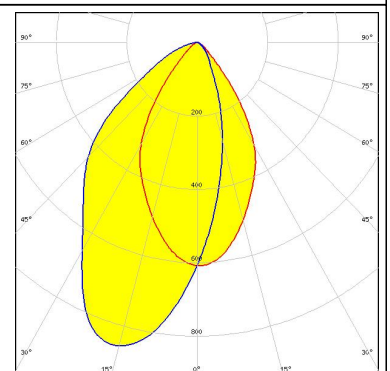
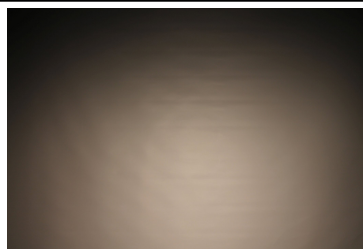



### PHOTOMETRIC DATA (MEASURED):

#### PHILIPS

LED Fortimo SLM L23 CoB  
FWHM Asymmetric  
Efficiency 80 %  
Peak intensity 0.8 cd/lm  
LEDs/each optic 1  
Light colour White  
Required components:  
C12692\_LENA-STD-BASE-CLL040  
C11996\_LENA-LENS

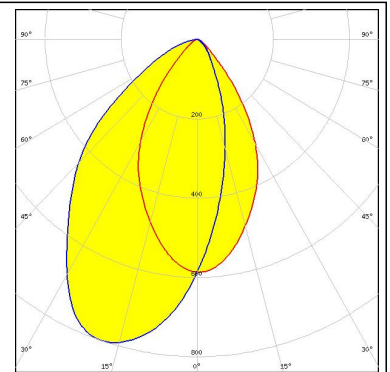
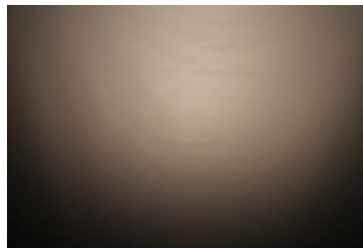

#### PHILIPS

LED Fortimo SLM L23 CoB  
FWHM Asymmetric  
Efficiency 85 %  
Peak intensity 0.9 cd/lm  
LEDs/each optic 1  
Light colour White  
Required components:  
C12692\_LENA-STD-BASE-CLL040

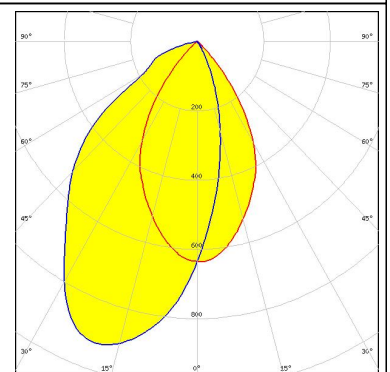
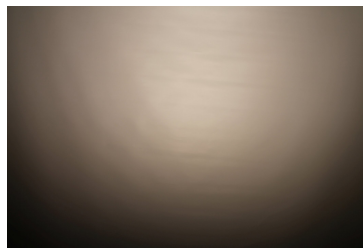

#### SAMSUNG

LED LC016D / LC019D / LC026D / LC033D  
FWHM Asymmetric  
Efficiency 89 %  
Peak intensity 1.1 cd/lm  
LEDs/each optic 1  
Light colour White  
Required components:  
C12691\_LENA-STD-BASE-CLL030

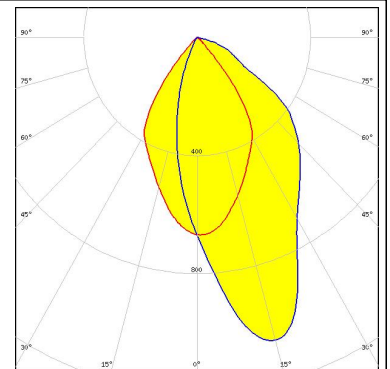

#### SAMSUNG

LED LC016D / LC019D / LC026D / LC033D  
FWHM Asymmetric  
Efficiency 84 %  
Peak intensity 0.9 cd/lm  
LEDs/each optic 1  
Light colour White  
Required components:  
C12691\_LENA-STD-BASE-CLL030  
C11996\_LENA-LENS

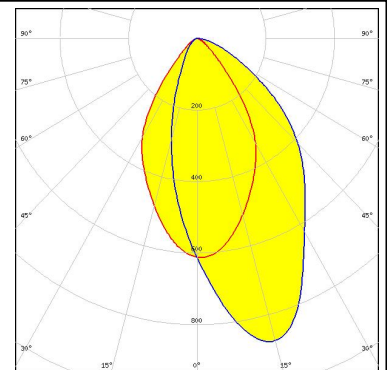

#### PHOTOMETRIC DATA (MEASURED):

### SHARP

LED Mega Zenigata (GW6DME)  
 FWHM Asymmetric  
 Efficiency 75 %  
 Peak intensity 0.8 cd/lm  
 LEDs/each optic 1  
 Light colour White  
 Required components:  
 C12292\_LENA-STD-BASE-MEZ  
 C11996\_LENA-LENS

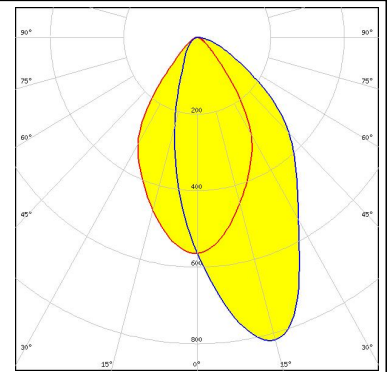

### SHARP

LED Mega Zenigata (GW6DME)  
 FWHM Asymmetric  
 Efficiency 80 %  
 Peak intensity 1 cd/lm  
 LEDs/each optic 1  
 Light colour White  
 Required components:  
 C12292\_LENA-STD-BASE-MEZ

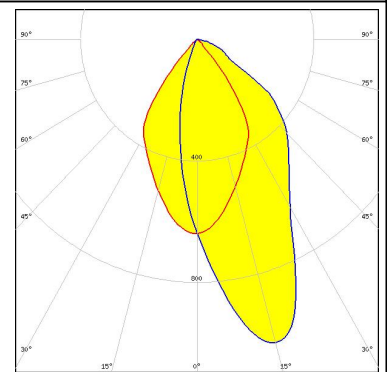

### TRIDONIC

LED SLE G7 LES15  
 FWHM Asymmetric  
 Efficiency 89 %  
 Peak intensity 1.1 cd/lm  
 LEDs/each optic 1  
 Light colour White  
 Required components:  
 C12691\_LENA-STD-BASE-CLL030

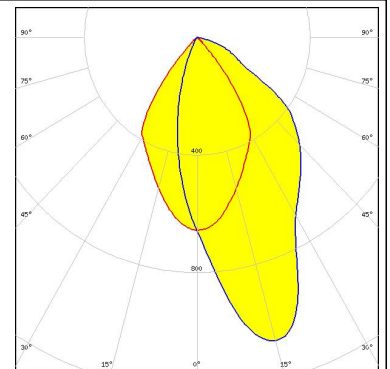

### TRIDONIC

LED SLE G7 LES17 H  
 FWHM Asymmetric  
 Efficiency 87 %  
 Peak intensity 1 cd/lm  
 LEDs/each optic 1  
 Light colour White  
 Required components:  
 C14547\_LENA-ADAPTER-B

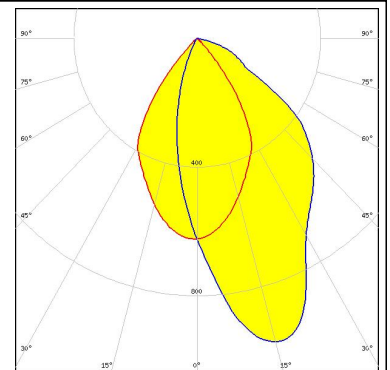

### PHOTOMETRIC DATA (MEASURED):

#### TRIDONIC

LED SLE G7 LES21 H  
FWHM Asymmetric  
Efficiency 86 %  
Peak intensity 0.9 cd/lm  
LEDs/each optic 1  
Light colour White  
Required components:  
C14547\_LENA-ADAPTER-B

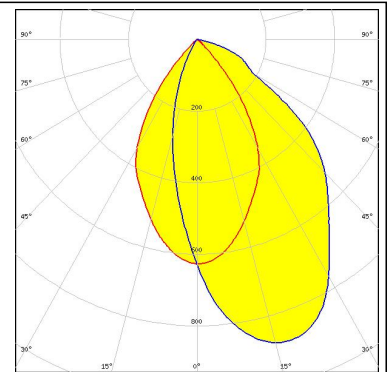
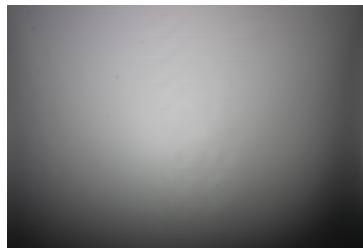

#### XICATO

LED XOB 14.5 mm  
FWHM Asymmetric  
Efficiency 91 %  
Peak intensity 1.2 cd/lm  
LEDs/each optic 1  
Light colour White  
Required components:  
C12691\_LENA-STD-BASE-CLL030

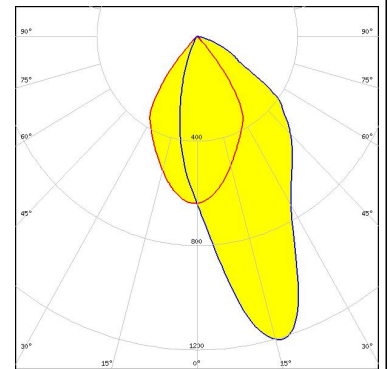
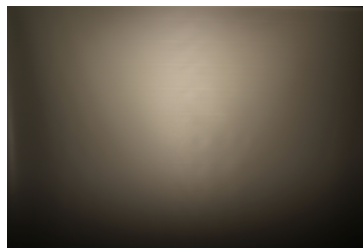

#### PHOTOMETRIC DATA (SIMULATED):

<p>bridgelux.</p> <p>LED V10 Gen7            FWHM Asymmetric            Efficiency 88 %            Peak intensity 1.4 cd/lm            LEDs/each optic 1            Light colour White</p> <p>Required components:            C13868_LENA-STD-BASE-VERO13-18            Bender Wirth: 486 Typ L1</p>	
<p>bridgelux.</p> <p>LED V10 Gen7            FWHM Asymmetric            Efficiency 81 %            Peak intensity 0.6 cd/lm            LEDs/each optic 1            Light colour White</p> <p>Required components:            C13868_LENA-STD-BASE-VERO13-18            C11996_LENA-LENS            Bender Wirth: 486 Typ L1</p>	
<p>bridgelux.</p> <p>LED V10 Gen7            FWHM Asymmetric            Efficiency 84 %            Peak intensity 1.1 cd/lm            LEDs/each optic 1            Light colour White</p> <p>Required components:            C13868_LENA-STD-BASE-VERO13-18            C11996_LENA-LENS            Bender Wirth: 486 Typ L1</p>	
<p>bridgelux.</p> <p>LED V13 Gen7            FWHM Asymmetric            Efficiency 88 %            Peak intensity 1.2 cd/lm            LEDs/each optic 1            Light colour White</p> <p>Required components:            C13868_LENA-STD-BASE-VERO13-18            Bender Wirth: 477 Typ L1</p>	



#### PHOTOMETRIC DATA (SIMULATED):

<p>bridgelux.</p> <p>LED V13 Gen7            FWHM Asymmetric            Efficiency 88 %            Peak intensity 1.1 cd/lm            LEDs/each optic 1            Light colour White</p> <p>Required components:            C13868_LENA-STD-BASE-VERO13-18            C11996_LENA-LENS            Bender Wirth: 477 Typ L1</p>	
<p>bridgelux.</p> <p>LED V13 Gen7            FWHM Asymmetric            Efficiency 84 %            Peak intensity 1 cd/lm            LEDs/each optic 1            Light colour White</p> <p>Required components:            C13868_LENA-STD-BASE-VERO13-18            C11996_LENA-LENS            Bender Wirth: 477 Typ L1</p>	
<p>bridgelux.</p> <p>LED V13 Gen7            FWHM Asymmetric            Efficiency 88 %            Peak intensity 1.3 cd/lm            LEDs/each optic 1            Light colour White</p> <p>Required components:            IDEAL: 50-2103CT + 50-2100LN</p>	
<p>bridgelux.</p> <p>LED V13 Gen7            FWHM Asymmetric            Efficiency 85 %            Peak intensity 1.1 cd/lm            LEDs/each optic 1            Light colour White</p> <p>Required components:            C11996_LENA-LENS</p>	

#### PHOTOMETRIC DATA (SIMULATED):



LED CXA/B 30xx  
 FWHM Asymmetric  
 Efficiency 85 %  
 Peak intensity 1.1 cd/lm  
 LEDs/each optic 1  
 Light colour White  
 Required components:  
 IDEAL: 50-2234C + 50-2100LN

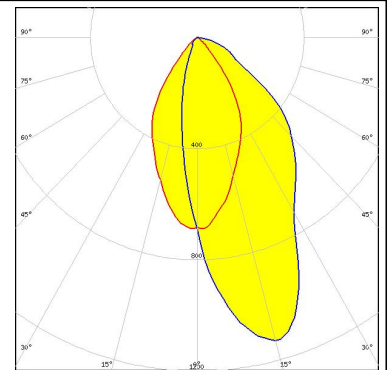

LED CXA/B 30xx  
 FWHM Asymmetric  
 Efficiency 81 %  
 Peak intensity 1 cd/lm  
 LEDs/each optic 1  
 Light colour White  
 Required components:  
 C11996\_LENA-LENS  
 IDEAL: 50-2234C + 50-2100LN

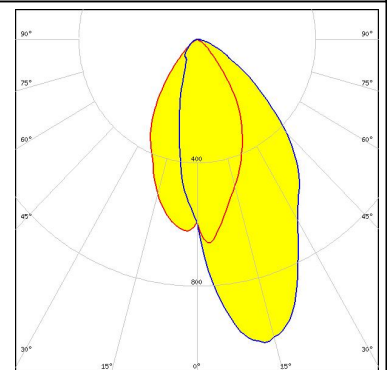

LED LUXEON CoB 1204/1205  
 FWHM Asymmetric  
 Efficiency 93 %  
 Peak intensity 1.7 cd/lm  
 LEDs/each optic 1  
 Light colour White  
 Required components:  
 C12292\_LENA-STD-BASE-MEZ

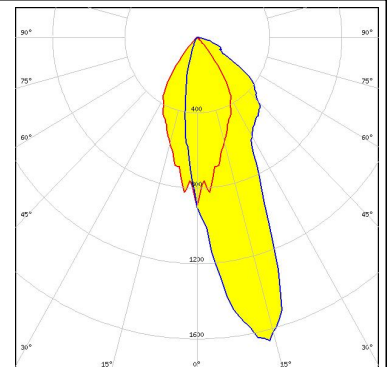

LED LUXEON CoB 1204/1205  
 FWHM Asymmetric  
 Efficiency 88 %  
 Peak intensity 1.1 cd/lm  
 LEDs/each optic 1  
 Light colour White  
 Required components:  
 C12292\_LENA-STD-BASE-MEZ  
 C11996\_LENA-LENS

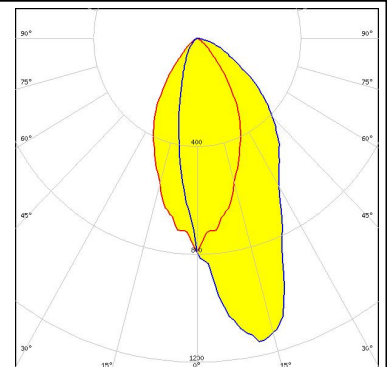

#### PHOTOMETRIC DATA (SIMULATED):

#### LUMILEDS

LED LUXEON CoB 1208  
 FWHM Asymmetric  
 Efficiency 92 %  
 Peak intensity 1.6 cd/lm  
 LEDs/each optic 1  
 Light colour White  
 Required components:  
 C12292\_LENA-STD-BASE-MEZ

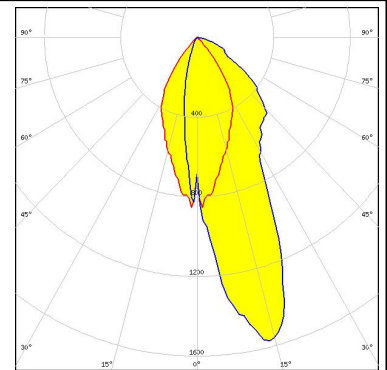

#### LUMILEDS

LED LUXEON CoB 1208  
 FWHM Asymmetric  
 Efficiency 87 %  
 Peak intensity 1.1 cd/lm  
 LEDs/each optic 1  
 Light colour White  
 Required components:  
 C12292\_LENA-STD-BASE-MEZ  
 C11996\_LENA-LENS

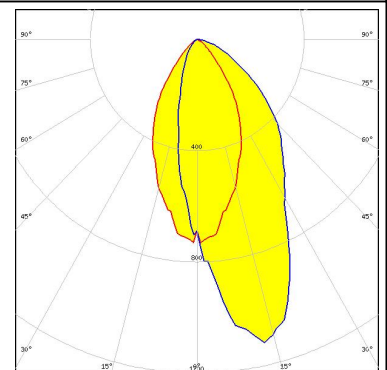

#### LUMINUS

LED CxM-14 (19x19)  
 FWHM Asymmetric  
 Efficiency 87 %  
 Peak intensity 0.5 cd/lm  
 LEDs/each optic 1  
 Light colour White  
 Required components:  
 C13868\_LENA-STD-BASE-VERO13-18  
 C11996\_LENA-LENS  
 Bender Wirth: 433 Typ L1

#### LUMINUS

LED CxM-14 (19x19)  
 FWHM Asymmetric  
 Efficiency 90 %  
 Peak intensity 1.1 cd/lm  
 LEDs/each optic 1  
 Light colour White  
 Required components:  
 C13868\_LENA-STD-BASE-VERO13-18  
 Bender Wirth: 433 Typ L1

#### PHOTOMETRIC DATA (SIMULATED):



**LED** CxM-14 (19x19)  
**FWHM** Asymmetric  
**Efficiency** 85 %  
**Peak intensity** 0.9 cd/lm  
**LEDs/each optic** 1  
**Light colour** White  
**Required components:**  
 C13868\_LENA-STD-BASE-VERO13-18  
 C11996\_LENA-LENS  
 Bender Wirth: 433 Typ L1



**LED** Soleriq S15  
**FWHM** Asymmetric  
**Efficiency** 88 %  
**Peak intensity** 1.2 cd/lm  
**LEDs/each optic** 1  
**Light colour** White  
**Required components:**  
 C12691\_LENA-STD-BASE-CLL030

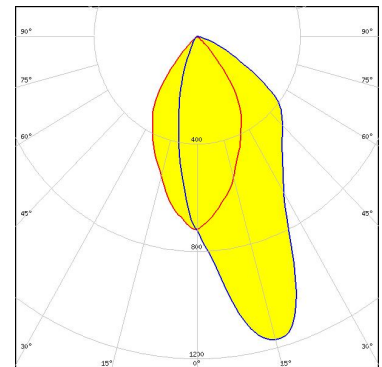



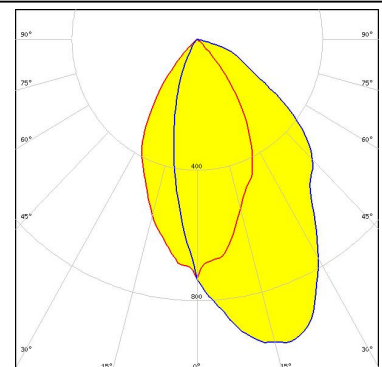

**LED** LC040D / LC060D / LC080D  
**FWHM** Asymmetric  
**Efficiency** 86 %  
**Peak intensity** 1 cd/lm  
**LEDs/each optic** 1  
**Light colour** White  
**Required components:**  
 C12692\_LENA-STD-BASE-CLL040

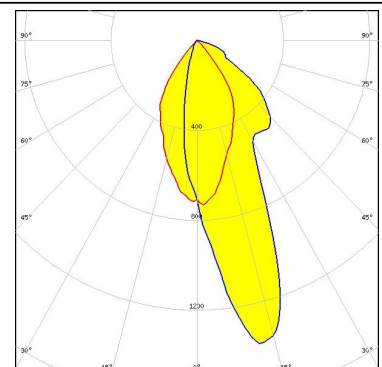

**LED** ZC12/18  
**FWHM** Asymmetric  
**Efficiency** 86 %  
**Peak intensity** 1.4 cd/lm  
**LEDs/each optic** 1  
**Light colour** White  
**Required components:**  
 C12691\_LENA-STD-BASE-CLL030

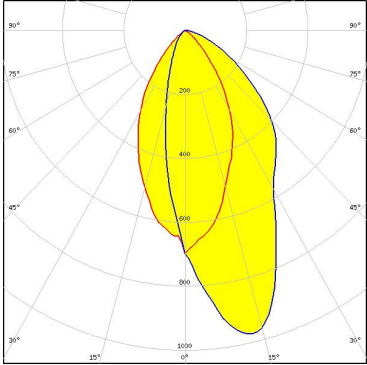

#### PHOTOMETRIC DATA (SIMULATED):

<p> SEUL SEMICONDUCTOR</p> <p>LED ZC12/18            FWHM Asymmetric            Efficiency 87 %            Peak intensity 0.5 cd/lm            LEDs/each optic 1            Light colour White</p> <p>Required components:            C13868_LENA-STD-BASE-VERO13-18            C11996_LENA-LENS            Bender Wirth: 433 Typ L1</p>	
<p> SEUL SEMICONDUCTOR</p> <p>LED ZC12/18            FWHM Asymmetric            Efficiency 90 %            Peak intensity 1.1 cd/lm            LEDs/each optic 1            Light colour White</p> <p>Required components:            C13868_LENA-STD-BASE-VERO13-18            Bender Wirth: 433 Typ L1</p>	
<p> SEUL SEMICONDUCTOR</p> <p>LED ZC12/18            FWHM Asymmetric            Efficiency %            LEDs/each optic 1            Light colour White</p> <p>Required components:            C12691_LENA-STD-BASE-CLL030            C11996_LENA-LENS</p>	
<p> SEUL SEMICONDUCTOR</p> <p>LED ZC12/18            FWHM Asymmetric            Efficiency 85 %            Peak intensity 0.9 cd/lm            LEDs/each optic 1            Light colour White</p> <p>Required components:            C13868_LENA-STD-BASE-VERO13-18            C11996_LENA-LENS            Bender Wirth: 433 Typ L1</p>	



## PHOTOMETRIC DATA (SIMULATED):

### SHARP

LED Mega Zenigata (GW5DGC)  
FWHM Asymmetric  
Efficiency %  
LEDs/each optic 1  
Light colour White  
Required components:  
C12292\_LENA-STD-BASE-MEZ

### SHARP

LED Mega Zenigata (GW5DGC)  
FWHM Asymmetric  
Efficiency %  
LEDs/each optic 1  
Light colour White  
Required components:  
C12292\_LENA-STD-BASE-MEZ  
C11996\_LENA-LENS

### GENERAL INFORMATION:

NOTE: The typical beam angle will be changed by different color, chip size and chip position tolerance. The typical total beam angle is the full angle measured where the luminous intensity is half of the peak value.

Due to use of high power COB's with this product, special attention to proper thermal design is highly recommended. LEDiL has no liability for direct, indirect or consecutive damages arising from the LEDiL products being used outside of the recommended temperature range.

### MATERIALS:

As part of our continuous research and improvement processes, and to ensure the best possible quality and availability of our products, LEDiL reserves the right to change material grades without notice.

### PRODUCT DATA USER AGREEMENT AND DISCLAIMER:

The measured data in the provided downloadable LEDiL Product Datasheets and Mechanical 2D-Drawings is rounded and provided as reference for planning. LEDiL Oy's optical specifications have been verified by conducting performance testing of the products in accordance with the company's quality system. The reported data are averaged results of multiple measurements with typical variation. LEDiL Oy reserves the right to without prior notification make changes and improvements to its products.

LEDiL Oy assumes neither warranty, nor guarantee nor any other liability of any kind for the contents and correctness of the provided data. The provided data has been generated with highest diligence but the provided data may in reality not represent the complete possible variation range of all intrinsic parameters. Therefore, in certain cases a deviation from the provided data could occur.

LEDiL Oy reserves the right to undertake technical changes of its products without further notification which could lead to changes in the provided data. LEDiL Oy assumes no liability of any kind for the possible deviation from any provided data or any other damage resulting from the usage of the provided data.

The user agrees to this disclaimer and user agreement with the download or usage of the provided files.

#### LEDiL Oy

Joensuunkatu 13  
FI-24240 SALO  
Finland

#### LEDiL Inc.

228 West Page Street  
Suite D  
Sycamore IL 60178  
USA

#### Local sales and technical support

[www.ledil.com/where\\_to\\_buy](http://www.ledil.com/where_to_buy)

#### Shipping locations

Salo, Finland  
Hong Kong, China

#### Distribution Partners

[www.ledil.com/where\\_to\\_buy](http://www.ledil.com/where_to_buy)

## Данный компонент на территории Российской Федерации

### Вы можете приобрести в компании MosChip.

Для оперативного оформления запроса Вам необходимо перейти по данной ссылке:

<http://moschip.ru/get-element>

Вы можете разместить у нас заказ для любого Вашего проекта, будь то серийное производство или разработка единичного прибора.

В нашем ассортименте представлены ведущие мировые производители активных и пассивных электронных компонентов.

Нашей специализацией является поставка электронной компонентной базы двойного назначения, продукции таких производителей как XILINX, Intel (ex.ALTERA), Vicor, Microchip, Texas Instruments, Analog Devices, Mini-Circuits, Amphenol, Glenair.

Сотрудничество с глобальными дистрибьюторами электронных компонентов, предоставляет возможность заказывать и получать с международных складов практически любой перечень компонентов в оптимальные для Вас сроки.

На всех этапах разработки и производства наши партнеры могут получить квалифицированную поддержку опытных инженеров.

Система менеджмента качества компании отвечает требованиям в соответствии с ГОСТ Р ИСО 9001, ГОСТ РВ 0015-002 и ЭС РД 009

### Офис по работе с юридическими лицами:

105318, г.Москва, ул.Щербаковская д.3, офис 1107, 1118, ДЦ «Щербаковский»

Телефон: +7 495 668-12-70 (многоканальный)

Факс: +7 495 668-12-70 (доб.304)

E-mail: [info@moschip.ru](mailto:info@moschip.ru)

Skype отдела продаж:

moschip.ru

moschip.ru\_4

moschip.ru\_6

moschip.ru\_9