

Analog Devices Welcomes Hittite Microwave Corporation

NO CONTENT ON THE ATTACHED DOCUMENT HAS CHANGED



THIS PAGE INTENTIONALLY LEFT BLANK

Typical Applications

Prescaler for DC to X Band PLL Applications:

- Satellite Communication Systems
- Fiber Optic
- Point-to-Point and Point-to-Multi-Point Radios
- VSAT

Features

- Ultra Low SSB Phase Noise: -149 dBc/Hz
- Wide Bandwidth
- Output Power: -6 dBm
- Single DC Supply: +5V
- S8G SMT Package

Functional Diagram

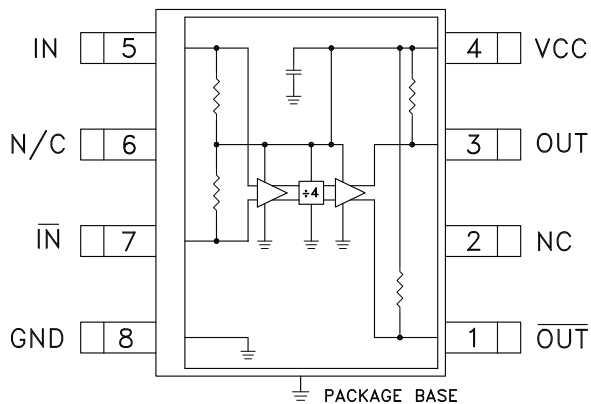

General Description

The HMC362S8G & HMC362S8GE are low noise Divide-by-4 Static Dividers with InGaP GaAs HBT technology in 8 lead surface mount plastic packages. This device operates from DC (with a square wave input) to 12 GHz input frequency with a single +5V DC supply. The low additive SSB phase noise of -149 dBc/Hz at 100 kHz offset helps the user maintain good system noise performance.

Electrical Specifications, $T_A = +25^\circ\text{C}$, 50 Ohm System, $V_{CC} = 5V$

| Parameter | Conditions | Min. | Typ. | Max. | Units |
|----------------------------------|---|------|------|------|--------|
| Maximum Input Frequency | | 12 | 13 | | GHz |
| Minimum Input Frequency | Sine Wave Input. [1] | | 0.2 | 0.5 | GHz |
| Input Power Range | $F_{in} = 1$ to 8 GHz | -15 | >-20 | +10 | dBm |
| | $F_{in} = 8$ to 10 GHz | -10 | >-15 | +3 | dBm |
| | $F_{in} = 10$ to 12 GHz | -5 | >-8 | 0 | dBm |
| Output Power | $F_{in} = 11$ GHz | -9 | -6 | | dBm |
| Reverse Leakage | Both RF Outputs Terminated | | 60 | | dB |
| SSB Phase Noise (100 kHz offset) | $P_{in} = 0\text{dBm}$, $F_{in} = 6$ GHz | | -149 | | dBc/Hz |
| Output Transition Time | $P_{in} = 0$ dBm, $F_{out} = 882$ MHz | | 100 | | ps |
| Supply Current (I_{CC}) | | | 68 | | mA |

1. Divider will operate down to DC for square-wave input signal.



Input Sensitivity Window, $T = 25\text{ }^{\circ}\text{C}$

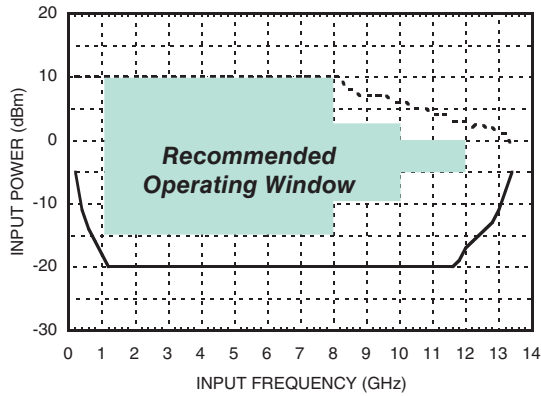

Input Sensitivity Window vs. Temperature

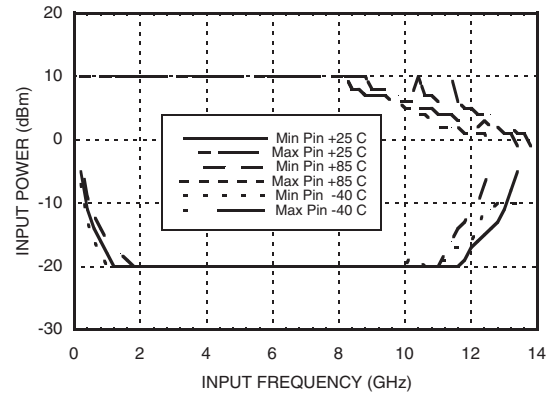

Output Power vs. Temperature

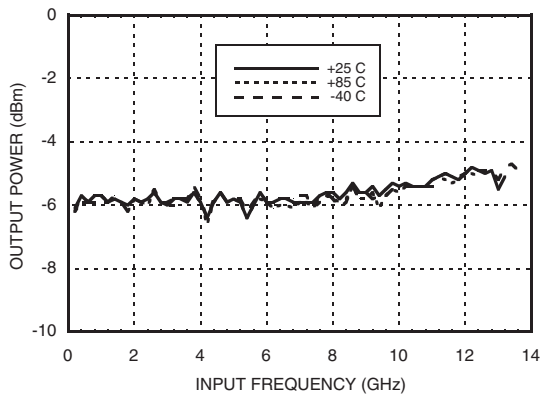

SSB Phase Noise

Performance, $P_{in} = 0\text{ dBm}$, $T = 25\text{ }^{\circ}\text{C}$

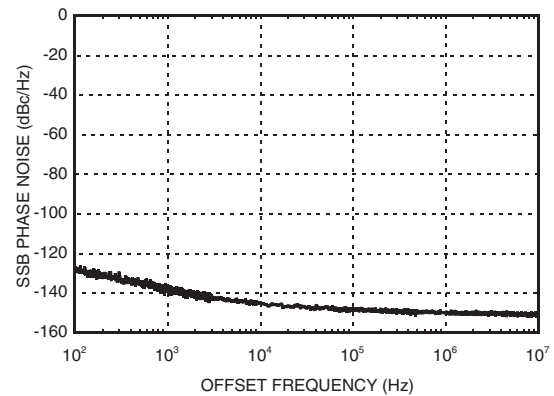

Output Harmonic

Content, $P_{in} = 0\text{ dBm}$, $T = 25\text{ }^{\circ}\text{C}$

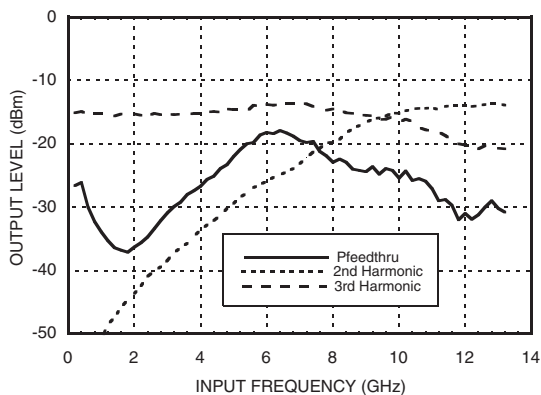

Reverse Leakage, $P_{in} = 0\text{ dBm}$, $T = 25\text{ }^{\circ}\text{C}$

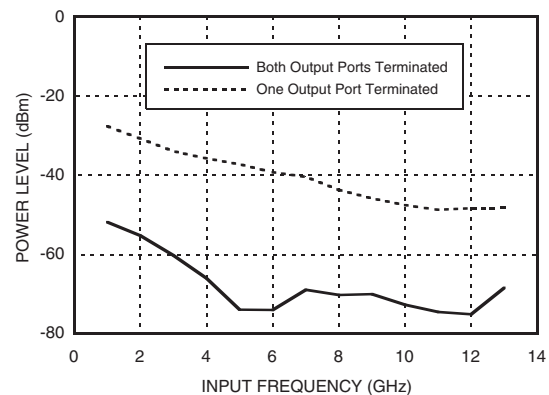

Output Voltage Waveform, Pin= 0 dBm, Fout= 882 MHz, T= 25 °C

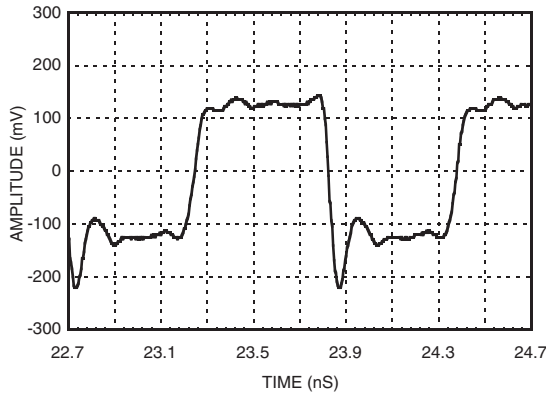

Absolute Maximum Ratings

| | |
|-----------------------|------------------------|
| RF Input (Vcc = +5V) | +13 dBm |
| Vcc | +5.5V |
| VLogic | Vcc -1.6V to Vcc -1.2V |
| Storage Temperature | -65 to +150 °C |
| Operating Temperature | -40 to +85 °C |



ELECTROSTATIC SENSITIVE DEVICE
OBSERVE HANDLING PRECAUTIONS

Typical Supply Current vs. Vcc

| Vcc (V) | Icc (mA) |
|---------|----------|
| 4.75 | 61 |
| 5.0 | 68 |
| 5.25 | 74 |

Note: Divider will operate over full voltage range shown above

Outline Drawing

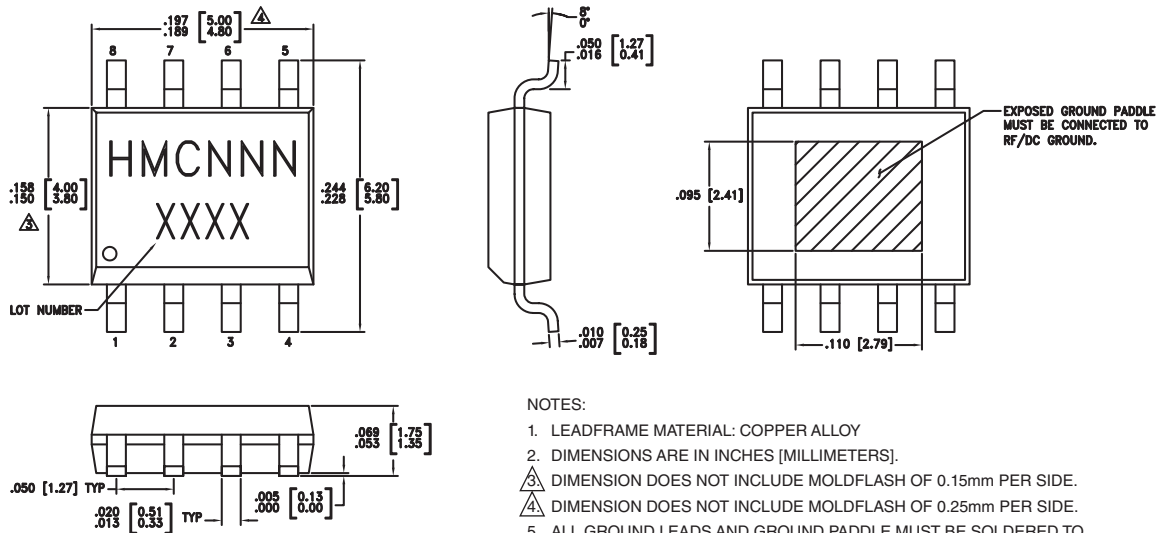

Package Information



| Part Number | Package Body Material | Lead Finish | MSL Rating | Package Marking ^[3] |
|-------------|--|---------------|---------------------|--------------------------------|
| HMC362S8G | Low Stress Injection Molded Plastic | Sn/Pb Solder | MSL1 ^[1] | HMC362 XXXX |
| HMC362S8GE | RoHS-compliant Low Stress Injection Molded Plastic | 100% matte Sn | MSL1 ^[2] | HMC362 XXXX |

[1] Max peak reflow temperature of 235 °C

[2] Max peak reflow temperature of 260 °C

[3] 4-Digit lot number XXXX

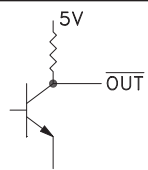
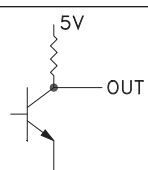
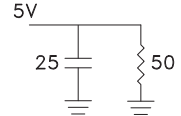
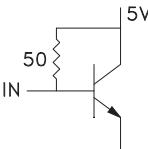
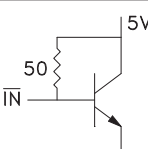
Pin Description

| Pin Number | Function | Description | Interface Schematic |
|------------|-------------------------|--|---|
| 1 | $\overline{\text{OUT}}$ | Divided output 180° out of phase with pin 3. |  |
| 2, 6 | N/C | No connection. These pins must not be grounded. | |
| 3 | OUT | Divided Output. |  |
| 4 | VCC | Supply voltage 5V ± 0.25V. |  |
| 5 | IN | RF Input must be DC blocked. |  |
| 7 | $\overline{\text{IN}}$ | RF Input 180° out of phase with pin 5 for differential operation. A/C ground for single ended operation |  |
| 8 | GND | Ground Backside of package has exposed metal ground slug which must be connected to ground. |  |

Evaluation PCB

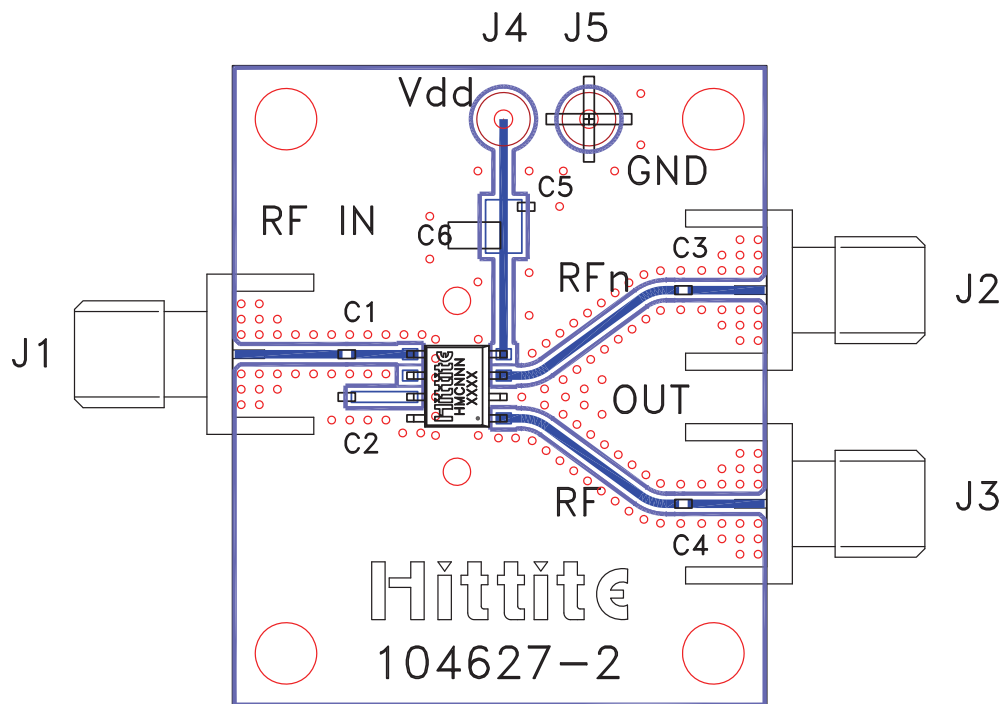

List of Materials for Evaluation PCB 104631 ^[1]

| Item | Description |
|---------|------------------------------------|
| J1 - J3 | PCB Mount SMA RF Connector |
| C1 - C4 | 100 pF Capacitor, 0402 Pkg. |
| C5 | 1000 pF Capacitor, 0603 Pkg. |
| C6 | 10 µF Tantalum Capacitor |
| U1 | HMC362S8G / HMC362S8GE Divide-by-4 |
| PCB [2] | 104627 Eval Board |

[1] Reference this number when ordering complete evaluation PCB

[2] Circuit Board Material: Rogers 4350

The circuit board used in the final application should use RF circuit design techniques. Signal lines should have 50 ohm impedance while the package ground leads and backside ground slug should be connected directly to the ground plane similar to that shown. A sufficient number of via holes should be used to connect the top and bottom ground planes. The evaluation circuit board shown is available from Hittite upon request. This evaluation board is designed for single ended input testing. J2 and J3 provide differential output signals.



Application Circuit

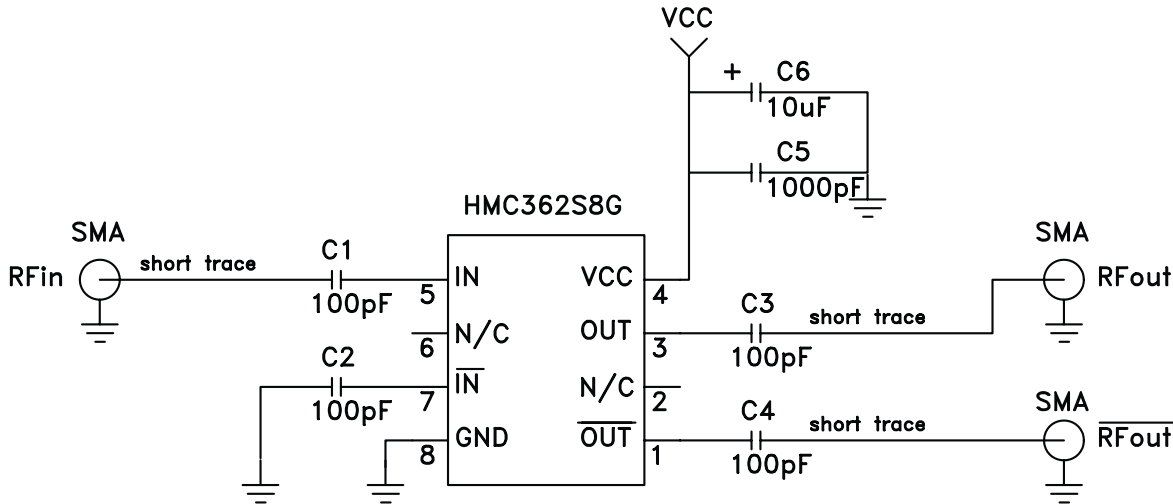

Данный компонент на территории Российской Федерации

Вы можете приобрести в компании MosChip.

Для оперативного оформления запроса Вам необходимо перейти по данной ссылке:

<http://moschip.ru/get-element>

Вы можете разместить у нас заказ для любого Вашего проекта, будь то серийное производство или разработка единичного прибора.

В нашем ассортименте представлены ведущие мировые производители активных и пассивных электронных компонентов.

Нашей специализацией является поставка электронной компонентной базы двойного назначения, продукции таких производителей как XILINX, Intel (ex.ALTERA), Vicor, Microchip, Texas Instruments, Analog Devices, Mini-Circuits, Amphenol, Glenair.

Сотрудничество с глобальными дистрибьюторами электронных компонентов, предоставляет возможность заказывать и получать с международных складов практически любой перечень компонентов в оптимальные для Вас сроки.

На всех этапах разработки и производства наши партнеры могут получить квалифицированную поддержку опытных инженеров.

Система менеджмента качества компании отвечает требованиям в соответствии с ГОСТ Р ИСО 9001, ГОСТ РВ 0015-002 и ЭС РД 009

Офис по работе с юридическими лицами:

105318, г.Москва, ул.Щербаковская д.3, офис 1107, 1118, ДЦ «Щербаковский»

Телефон: +7 495 668-12-70 (многоканальный)

Факс: +7 495 668-12-70 (доб.304)

E-mail: info@moschip.ru

Skype отдела продаж:

moschip.ru

moschip.ru_4

moschip.ru_6

moschip.ru_9