

Low Cost 3.3 V Spread Aware Zero Delay Buffer

Features

- 10 MHz to 100 MHz and 133 MHz operating range, compatible with CPU and PCI bus frequencies
- Zero input-output propagation delay
- Multiple low skew outputs
 - Output-output skew less than 250 ps
 - Device-device skew less than 700 ps
 - One input drives five outputs (CY23S05)
 - One input drives nine outputs, grouped as 4 + 4 + 1 (CY23S09)
- Less than 200 ps Cycle-to-cycle jitter
- Test mode to bypass PLL (CY23S09 only, see [Select Input Decoding for CY23S09](#) on page 4)
- Available in space saving 16-pin, 150-mil SOIC, 4.4 mm TSSOP (CY23S09) or 8-pin, 150-mil SOIC package (CY23S05)
- 3.3 V operation, advanced 0.65μ CMOS technology
- Spread Aware

Functional Description

The CY23S09 is a low cost 3.3 V zero delay buffer designed to distribute high speed clocks and is available in a 16-pin SOIC package. The CY23S05 is an 8-pin version of the CY23S09. It accepts one reference input, and drives out five low skew clocks. The -1H versions of each device operate at up to 100 and 133 MHz frequencies and have higher drive than the -1 devices.

All parts have on-chip PLLs that lock to an input clock on the REF pin. The PLL feedback is on-chip and is obtained from the CLKOUT pad.

The CY23S09 has two banks of four outputs each, which can be controlled by the select inputs as shown in the Select Input Decoding table on [Select Input Decoding for CY23S09](#) on page 4. If all output clocks are not required, Bank B can be three-stated. The select inputs also allow the input clock to be directly applied to the outputs for chip and system testing purposes.

The CY23S09 and CY23S05 PLLs enter a power down mode when there are no rising edges on the REF input. In this state, the outputs are three-stated and the PLL is turned off, resulting in less than 12.0 μA of current draw (for commercial temperature devices) and 25.0 μA (for industrial temperature devices). The CY23S09 PLL shuts down in one additional case, as shown in the [Select Input Decoding for CY23S09](#) on page 4.

Multiple CY23S09 and CY23S05 devices can accept the same input clock and distribute it. In this case, the skew between the outputs of two devices is guaranteed to be less than 700 ps.

All outputs have less than 200 ps of cycle-to-cycle jitter. The input to output propagation delay on both devices is guaranteed to be less than 350 ps; the output to output skew is guaranteed to be less than 250 ps.

The CY23S05 and CY23S09 is available in two different configurations, as shown in the [Ordering Information](#) on page 8. The CY23S05-1 and CY23S09-1 is the base part. The CY23S05-1H and CY23S09-1H is the high drive version of the -1, and its rise and fall times are much faster than -1.

For a complete list of related resources, click [here](#).

Logic Block Diagram



Contents

Pinouts	3	Thermal Resistance	7
Select Input Decoding for CY23S09	4	Ordering Information	8
Functional Overview	4	Ordering Code Definitions	8
Zero Delay and Skew Control	4	Package Diagrams	9
Spread Aware.....	4	Acronym	11
Maximum Ratings	5	Document Conventions	11
Operating Conditions for CY23S05SXX-XX and		Units of Measure	11
CY23S09SXX-XX (Industrial, Commercial Devices)	5	Document History Page	12
Electrical Characteristics for CY23S05SXX-XX and		Sales, Solutions, and Legal Information	13
CY23S09SXX-XX (Industrial, Commercial Devices)	5	Worldwide Sales and Design Support.....	13
Switching Characteristics for CY23S05SXC-1 and		Products	13
CY23S09SXC-1 Commercial Temperature Devices	5	PSoC® Solutions	13
Switching Characteristics for CY23S05SXI-1H Industrial		Cypress Developer Community.....	13
Temperature Devices	6	Technical Support	13
Switching Waveforms	6		
Test Circuits	7		

Pinouts

Figure 1. Pin Configuration – CY23S09



Figure 2. Pin Configuration – CY23S05



Table 1. Pin Description for CY23S09

Pin	Signal	Description
1	REF ^[1]	Input reference frequency, 5 V tolerant input
2	CLKA1 ^[2]	Buffered clock output, bank A
3	CLKA2 ^[2]	Buffered clock output, bank A
4	V _{DD}	3.3 V supply
5	GND	Ground
6	CLKB1 ^[2]	Buffered clock output, bank B
7	CLKB2 ^[2]	Buffered clock output, bank B
8	S2 ^[3]	Select input, bit 2
9	S1 ^[3]	Select input, bit 1
10	CLKB3 ^[2]	Buffered clock output, bank B
11	CLKB4 ^[2]	Buffered clock output, bank B
12	GND	Ground
13	V _{DD}	3.3 V supply
14	CLKA3 ^[2]	Buffered clock output, bank A
15	CLKA4 ^[2]	Buffered clock output, bank A
16	CLKOUT ^[2]	Buffered output, internal feedback on this pin

Table 2. Pin Description for CY23S05

Pin	Signal	Description
1	REF ^[1]	Input reference frequency, 5 V tolerant input
2	CLK2 ^[2]	Buffered clock output
3	CLK1 ^[2]	Buffered clock output
4	GND	Ground
5	CLK3 ^[2]	Buffered clock output
6	V _{DD}	3.3 V supply
7	CLK4 ^[2]	Buffered clock output
8	CLKOUT ^[2]	Buffered clock output, internal feedback on this pin

Notes

1. Weak pull down.
2. Weak pull down on all outputs.
3. Weak pull up on these inputs.

Select Input Decoding for CY23S09

S2	S1	CLOCK A1–A4	CLOCK B1–B4	CLKOUT ^[4]	Output Source	PLL Shutdown
0	0	Three-state	Three-state	Driven	PLL	N
0	1	Driven	Three-state	Driven	PLL	N
1	0	Driven	Driven	Driven	Reference	Y
1	1	Driven	Driven	Driven	PLL	N

Functional Overview

Zero Delay and Skew Control

All outputs must be uniformly loaded to achieve Zero Delay between the input and output. Because the CLKOUT pin is the internal feedback to the PLL, its relative loading can adjust the input-output delay. This is shown in the above graph.

For applications requiring zero input-output delay, all outputs, including CLKOUT, must be equally loaded. Even if CLKOUT is not used, it must have a capacitive load equal to that on other outputs, to obtain zero input-output delay. If input to output delay adjustments are required, use the above graph to calculate loading differences between the CLKOUT pin and other outputs.

For zero output-output skew, be sure to load all outputs equally. For further information refer to the application note titled [AN1234 - Understanding Cypress's Zero Delay Buffers](#).

Spread Aware

Many systems being designed now use a technology called Spread Spectrum Frequency Timing Generation. Cypress is one of the pioneers of SSFTG development and designed this product so as not to filter off the Spread Spectrum feature of the Reference input, assuming it exists. When a zero delay buffer is not designed to pass the SS feature through, the result is a significant amount of tracking skew, which may cause problems in systems requiring synchronization.

For more details on Spread Spectrum timing technology, please see the Cypress Whitepaper [EMI and Spread Spectrum Technology](#).

Figure 3. REF. Input to CLKA/CLKB Delay vs. Loading Difference between CLKOUT and CLKA/CLKB Pins



Note

4. This output is driven and has an internal feedback for the PLL. The load on this output can be adjusted to change the skew between the reference and output.

Maximum Ratings

Supply voltage to ground potential	-0.5 V to +7.0 V	Maximum soldering temperature (10 seconds)	260 °C
DC input voltage (Except REF)	-0.5 V to $V_{DD} + 0.5$ V	Junction temperature.....	150 °C
DC input voltage REF	-0.5 V to 7 V	Static discharge voltage	
Storage temperature	-65 °C to +150 °C	(per MIL-STD-883, Method 3015)	> 2,000 V

Operating Conditions for CY23S05SXX-XX and CY23S09SXX-XX (Industrial, Commercial Devices)^[5]

Parameter	Description	Min	Max	Unit
V_{DD}	Supply voltage	3.0	3.6	V
T_A	Operating temperature - Ambient (Commercial)	0	70	°C
	Operating temperature - Ambient (Industrial)	-40	85	°C
C_L	Load capacitance, below 100 MHz		30	pF
C_L	Load capacitance, from 100 MHz to 133 MHz		10	pF
C_{IN}	Input capacitance		7	pF

Electrical Characteristics for CY23S05SXX-XX and CY23S09SXX-XX (Industrial, Commercial Devices)

Parameter	Description	Test Conditions	Min	Max	Unit
V_{IL}	Input LOW voltage ^[6]			0.8	V
V_{IH}	Input HIGH voltage ^[6]		2.0		V
I_{IL}	Input LOW current	$V_{IN} = 0$ V		50.0	μA
I_{IH}	Input HIGH current	$V_{IN} = V_{DD}$		100.0	μA
V_{OL}	Output LOW voltage ^[7]	$I_{OL} = 8$ mA (-1) $I_{OH} = 12$ mA (-1H)		0.4	V
V_{OH}	Output HIGH voltage ^[7]	$I_{OH} = -8$ mA (-1) $I_{OL} = -12$ mA (-1H)	2.4		V
I_{DD} (PD mode)	Power-down supply current	REF = 0 MHz		12.0	μA
I_{DD}	Supply current	Unloaded outputs at 66.67 MHz, SEL inputs at V_{DD}		32.0	mA

Switching Characteristics for CY23S05SXC-1 and CY23S09SXC-1 Commercial Temperature Devices^[8]

Parameter	Description	Test Conditions	Min	Typ	Max	Unit
t_1	Output frequency	30 pF load	10		100	MHz
		10 pF load	10		133.33	MHz
	Duty cycle ^[7] = $t_2 \div t_1$	Measured at 1.4 V, $F_{out} = 66.67$ MHz	40.0	50.0	60.0	%
t_3	Rise time ^[7]	Measured between 0.8 V and 2.0 V			2.50	ns
t_4	Fall time ^[7]	Measured between 0.8 V and 2.0 V			2.50	ns
t_5	Output-to-output skew ^[7]	All outputs equally loaded			250	ps
t_6	Delay, REF Rising Edge to CLKOUT Rising Edge ^[7]	Measured at $V_{DD}/2$		0	±350	ps
t_7	Device-to-device skew ^[7]	Measured at $V_{DD}/2$ on the CLKOUT pins		0	700	ps
t_J	Cycle-to-cycle jitter ^[7]	Measured at 66.67 MHz, loaded outputs			200	ps
t_{LOCK}	PLL lock time ^[7]	Stable power supply, valid clock presented on REF pin			1.0	ms

Notes

5. Multiple Supplies: The voltage on any input or I/O pin cannot exceed the power pin during power up. Power supply sequencing is NOT required.
6. REF input has a threshold voltage of $V_{DD}/2$.
7. Parameter is guaranteed by design and characterization. Not 100% tested in production.
8. All parameters specified with loaded outputs.

Switching Characteristics for CY23S05SXI-1H Industrial Temperature Devices^[8]

Parameter	Description	Test Conditions	Min	Typ	Max	Unit
t1	Output frequency	30 pF load 10 pF load	10 10		100 133.33	MHz MHz
	Duty cycle ^[7] = $t_2 \div t_1$	Measured at 1.4 V, $F_{out} = 66.67$ MHz	40.0	50.0	60.0	%
	Duty cycle ^[7] = $t_2 \div t_1$	Measured at 1.4 V, $F_{out} < 50.0$ MHz	45.0	50.0	55.0	%
t3	Rise time ^[7]	Measured between 0.8 V and 2.0 V			1.50	ns
t4	Fall time ^[7]	Measured between 0.8 V and 2.0 V			1.50	ns
t5	Output-to-output skew ^[7]	All outputs equally loaded			250	ps
t6	Delay, REF Rising Edge to CLKOUT Rising Edge ^[7]	Measured at $V_{DD}/2$		0	± 350	ps
t7	Device-to-Device Skew ^[7]	Measured at $V_{DD}/2$ on the CLKOUT pins of devices		0	700	ps
t8	Output slew rate ^[7]	Measured between 0.8 V and 2.0 V using Test Circuit #2	1			V/ns
t _J	Cycle-to-cycle jitter ^[7]	Measured at 66.67 MHz, loaded outputs			200	ps
t _{LOCK}	PLL lock time ^[7]	Stable power supply, valid clock presented on REF pin			1.0	ms

Switching Waveforms

Figure 4. Duty Cycle Timing

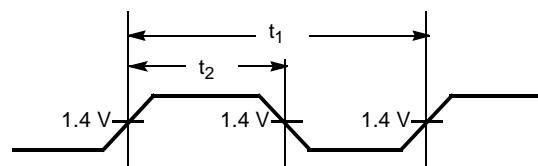

Figure 5. All Outputs Rise/Fall Time

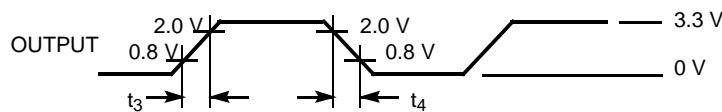

Figure 6. Output-Output Skew

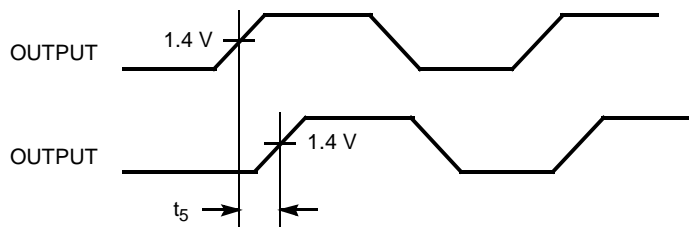
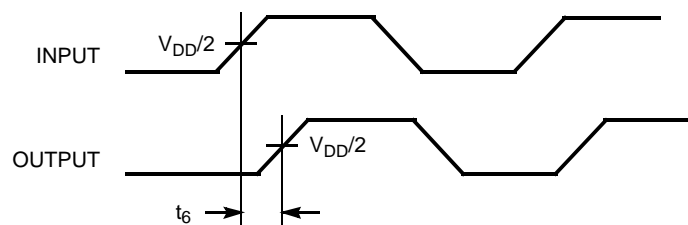

Figure 7. Input-Output Propagation Delay



Switching Waveforms continued

Figure 8. Device-Device Skew



Test Circuits



For parameter t8 (output slew rate) on -1H devices

Thermal Resistance

Parameter ^[9]	Description	Test Conditions	8-pin SOIC	16-pin SOIC	16-pin TSSOP	Unit
Theta J _A	Thermal resistance (junction to ambient)	Test conditions follow standard test methods and procedures for measuring thermal impedance, in accordance with EIA/JESD51.	132	108	108	°C/W
Theta J _C	Thermal resistance (junction to case)		43	37	17	°C/W

Note

9. These parameters are guaranteed by design and are not tested.

Ordering Information

Ordering Code	Package Name	Package Type	Operating Range
Pb-Free			
CY23S05SXC-1	SZ08	8-pin 150-mil SOIC	Commercial (0 ° to 70 °C)
CY23S05SXC-1T	SZ08	8-pin 150-mil SOIC – Tape and Reel	Commercial (0 ° to 70 °C)
CY23S05SXC-1H	SZ08	8-pin 150-mil SOIC	Commercial (0 ° to 70 °C)
CY23S05SXC-1HT	SZ08	8-pin 150-mil SOIC – Tape and Reel	Commercial (0 ° to 70 °C)
CY23S05SXI-1	SZ08	8-pin 150-mil SOIC	Industrial (–40 ° to 85 °C)
CY23S05SXI-1T	SZ08	8-pin 150-mil SOIC – Tape and Reel	Industrial (–40 ° to 85 °C)
CY23S09SXC-1	SZ16	16-pin 150-mil SOIC	Commercial (0 ° to 70 °C)
CY23S09SXC-1T	SZ16	16-pin 150-mil SOIC – Tape and Reel	Commercial (0 ° to 70 °C)
CY23S09SXC-1H	SZ16	16-pin 150-mil SOIC	Commercial (0 ° to 70 °C)
CY23S09SXC-HT	SZ16	16-pin 150-mil SOIC – Tape and Reel	Commercial (0 ° to 70 °C)
CY23S09ZXC-1H	ZZ16	16-pin 4.4 mm TSSOP	Commercial (0 ° to 70 °C)
CY23S09ZXC-1HT	ZZ16	16-pin 4.4 mm TSSOP – Tape and Reel	Commercial (0 ° to 70 °C)

Ordering Code Definitions

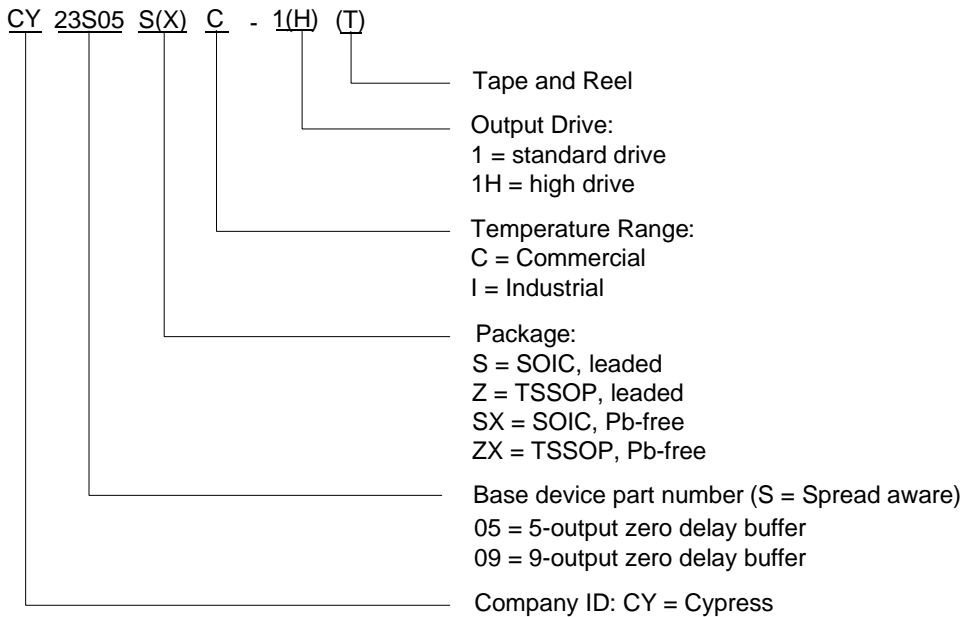

Package Diagrams

Figure 9. 8-Pin (150-Mil) SOIC S08 and SZ08

1. DIMENSIONS IN INCHES[MM] MIN. MAX.
2. PIN 1 ID IS OPTIONAL, ROUND ON SINGLE LEADFRAME RECTANGULAR ON MATRIX LEADFRAI
3. REFERENCE JEDEC MS-012
4. PACKAGE WEIGHT 0.07gms

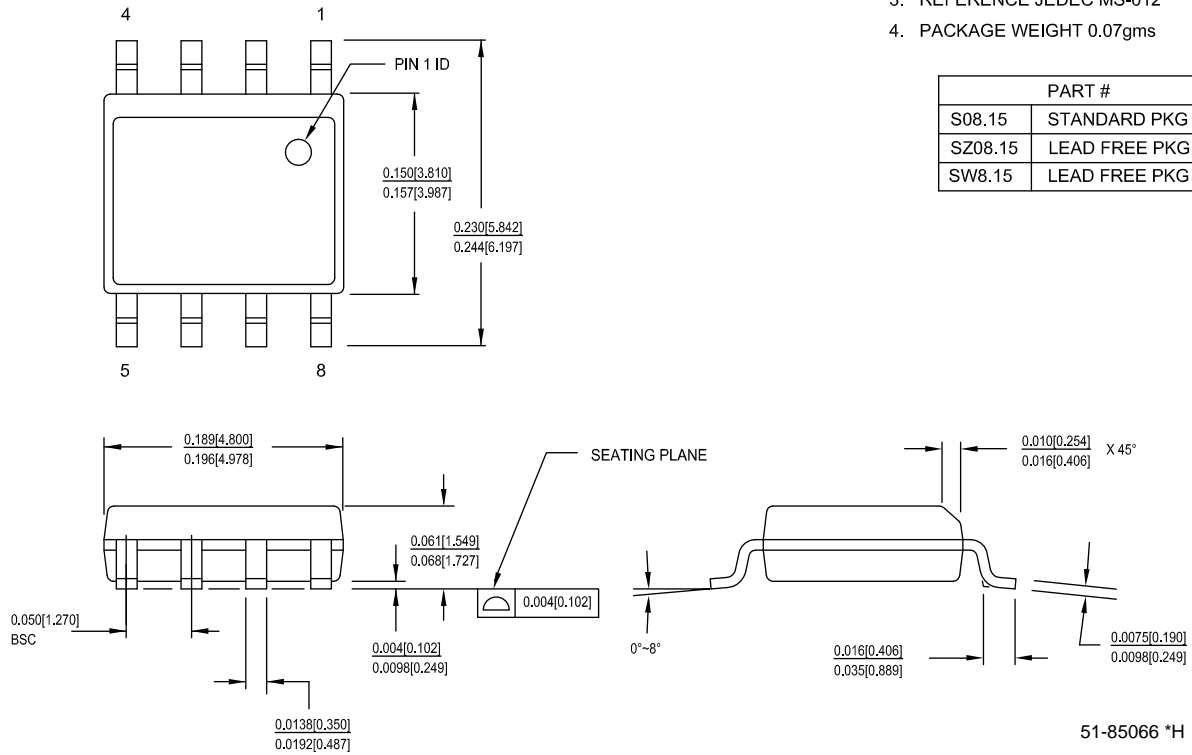

Package Diagrams continued

Figure 10. 16-Pin (150-Mil) SOIC S16 and SZ16



Figure 11. 16-Pin TSSOP 4.40 mm Body Z16 and ZZ16

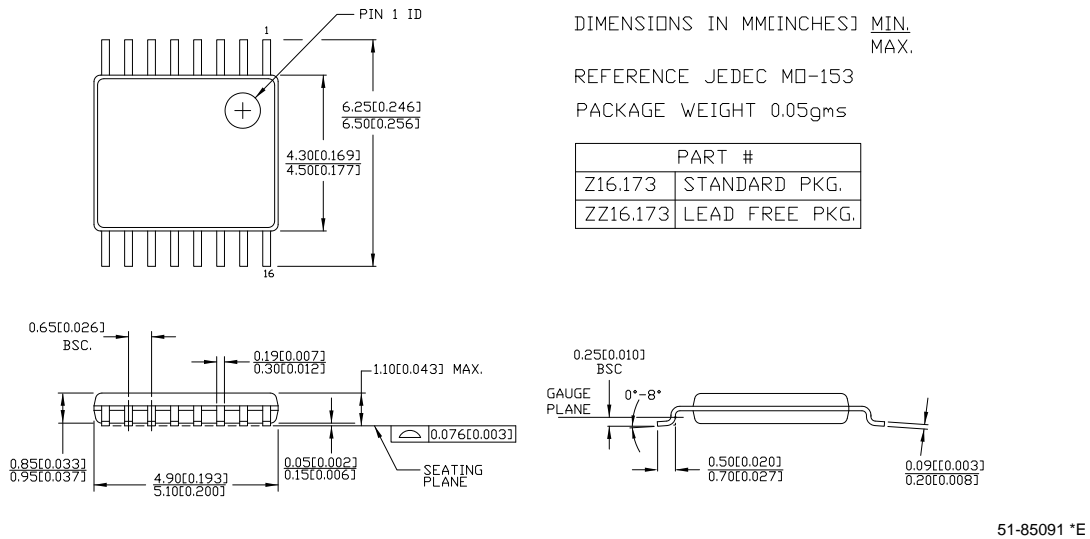

Acronym

Acronym	Description
CMOS	complementary metal oxide semiconductor
EMI	electromagnetic interference
PLL	phase-locked loop
SOIC	small outline integrated circuit
SS	spread spectrum
SSFTG	spread spectrum frequency timing generator
SSOP	shrunk small outline package
TSSOP	thin shrunk small outline package

Document Conventions

Units of Measure

Symbol	Unit of Measure
°C	degree Celsius
MHZ	megahertz
uA	microamperes
mA	milliamperes
ms	milliseconds
ns	nanoseconds
%	percent
pF	picofarads
ps	picoseconds
V	volt

Document History Page

Document Title: CY23S09/CY23S05 Low Cost 3.3 V Spread Aware Zero Delay Buffer				
Document Number: 38-07296				
Rev.	ECN No.	Submission Date	Orig. of Change	Description of Change
**	111147	11/14/01	DSG	Changed from spec number 38-01094 to 38-07296
*A	111773	02/20/02	CTK	Added 150-mil SSOP option
*B	122885	12/22/02	RBI	Added power-up requirements to Operating Conditions
*C	267849	See ECN	RGL	Added Lead-Free devices
*D	2595524	10/23/08	CXQ/PYRS	Added device "Status" to Ordering Information
*E	2761988	09/10/09	KVM	Removed obsolete parts from Ordering Information table: CY23S09ZC-1, CY23S09OC-1, CY23S09OC-1H, CY23S09ZXC-1, CY23S09OXC-1, CY23S09OXC-1H. Added CY23S05SXC-1T, CY23S05SXC-1HT, CY23S09SXC-1T, CY23S09SXC-1HT, CY23S09ZXC-1HT. Removed Status column from Ordering Information table; added footnote. Updated package names and added numerical temperature range to Ordering Information table. Removed QSOP package drawing.
*F	2897373	03/22/10	CXQ	Removed part numbers CY23S05SC-1, CY23S05SC-1H, CY23S09SC-1, CY23S09SC-1H, and CY23S09ZC-1H from Ordering Information table. Added CY23S05SXI-1 and CY23S05SXI-1T to Ordering Information table. Updated package diagrams. Updated copyright section.
*G	3394655	10/04/11	PURU	Added Figure 3 Updated Hyper links Updated Package Diagrams Added Ordering Code Definitions , Acronym , and Units of Measure .
*H	4564025	11/07/2014	TAVA	Removed the SSOP package in Features . Updated Figure 1 (removed SSOP). Updated Figure 7 . Replaced all occurrences of SC and SI with SXC and SXI in the following tables: Operating Conditions for CY23S05SXX-XX and CY23S09SXX-XX (Industrial, Commercial Devices) ^[5] Electrical Characteristics for CY23S05SXX-XX and CY23S09SXX-XX (Industrial, Commercial Devices) Switching Characteristics for CY23S05SXC-1 and CY23S09SXC-1 Commercial Temperature Devices ^[8] Switching Characteristics for CY23S05SXI-1H Industrial Temperature Devices ^[8] Updated the table, Operating Conditions for CY23S05SXX-XX and CY23S09SXX-XX (Industrial, Commercial Devices) ^[5] . Removed CY23S09SI-1H in the table title, in Switching Characteristics for CY23S05SXI-1H Industrial Temperature Devices ^[8] . Updated Figure 9 , Figure 10 , and Figure 11 in Package Diagrams .
*I	5738816	05/24/2017	PSR	Updated the link for AN1234. Added Thermal Resistance . Updated the Cypress logo, copyright information, Sales , Solutions , and Legal Information based on the new template.

Sales, Solutions, and Legal Information

Worldwide Sales and Design Support

Cypress maintains a worldwide network of offices, solution centers, manufacturer's representatives, and distributors. To find the office closest to you, visit us at [Cypress Locations](#).

Products

ARM [®] Cortex [®] Microcontrollers	cypress.com/arm
Automotive	cypress.com/automotive
Clocks & Buffers	cypress.com/clocks
Interface	cypress.com/interface
Internet of Things	cypress.com/iot
Memory	cypress.com/memory
Microcontrollers	cypress.com/mcu
PSoC	cypress.com/psoc
Power Management ICs	cypress.com/pmic
Touch Sensing	cypress.com/touch
USB Controllers	cypress.com/usb
Wireless Connectivity	cypress.com/wireless

PSoC[®] Solutions

[PSoC 1](#) | [PSoC 3](#) | [PSoC 4](#) | [PSoC 5LP](#) | [PSoC 6](#)

Cypress Developer Community

[Forums](#) | [WICED IOT Forums](#) | [Projects](#) | [Video](#) | [Blogs](#) | [Training](#) | [Components](#)

Technical Support

cypress.com/support

© Cypress Semiconductor Corporation, 2001-2017. This document is the property of Cypress Semiconductor Corporation and its subsidiaries, including Spansion LLC ("Cypress"). This document, including any software or firmware included or referenced in this document ("Software"), is owned by Cypress under the intellectual property laws and treaties of the United States and other countries worldwide. Cypress reserves all rights under such laws and treaties and does not, except as specifically stated in this paragraph, grant any license under its patents, copyrights, trademarks, or other intellectual property rights. If the Software is not accompanied by a license agreement and you do not otherwise have a written agreement with Cypress governing the use of the Software, then Cypress hereby grants you a personal, non-exclusive, nontransferable license (without the right to sublicense) (1) under its copyright rights in the Software (a) for Software provided in source code form, to modify and reproduce the Software solely for use with Cypress hardware products, only internally within your organization, and (b) to distribute the Software in binary code form externally to end users (either directly or indirectly through resellers and distributors), solely for use on Cypress hardware product units, and (2) under those claims of Cypress's patents that are infringed by the Software (as provided by Cypress, unmodified) to make, use, distribute, and import the Software solely for use with Cypress hardware products. Any other use, reproduction, modification, translation, or compilation of the Software is prohibited.

TO THE EXTENT PERMITTED BY APPLICABLE LAW, CYPRESS MAKES NO WARRANTY OF ANY KIND, EXPRESS OR IMPLIED, WITH REGARD TO THIS DOCUMENT OR ANY SOFTWARE OR ACCOMPANYING HARDWARE, INCLUDING, BUT NOT LIMITED TO, THE IMPLIED WARRANTIES OF MERCHANTABILITY AND FITNESS FOR A PARTICULAR PURPOSE. To the extent permitted by applicable law, Cypress reserves the right to make changes to this document without further notice. Cypress does not assume any liability arising out of the application or use of any product or circuit described in this document. Any information provided in this document, including any sample design information or programming code, is provided only for reference purposes. It is the responsibility of the user of this document to properly design, program, and test the functionality and safety of any application made of this information and any resulting product. Cypress products are not designed, intended, or authorized for use as critical components in systems designed or intended for the operation of weapons, weapons systems, nuclear installations, life-support devices or systems, other medical devices or systems (including resuscitation equipment and surgical implants), pollution control or hazardous substances management, or other uses where the failure of the device or system could cause personal injury, death, or property damage ("Unintended Uses"). A critical component is any component of a device or system whose failure to perform can be reasonably expected to cause the failure of the device or system, or to affect its safety or effectiveness. Cypress is not liable, in whole or in part, and you shall and hereby do release Cypress from any claim, damage, or other liability arising from or related to all Unintended Uses of Cypress products. You shall indemnify and hold Cypress harmless from and against all claims, costs, damages, and other liabilities, including claims for personal injury or death, arising from or related to any Unintended Uses of Cypress products.

Cypress, the Cypress logo, Spansion, the Spansion logo, and combinations thereof, WICED, PSoC, CapSense, EZ-USB, F-RAM, and Traveo are trademarks or registered trademarks of Cypress in the United States and other countries. For a more complete list of Cypress trademarks, visit cypress.com. Other names and brands may be claimed as property of their respective owners

Данный компонент на территории Российской Федерации

Вы можете приобрести в компании MosChip.

Для оперативного оформления запроса Вам необходимо перейти по данной ссылке:

<http://moschip.ru/get-element>

Вы можете разместить у нас заказ для любого Вашего проекта, будь то серийное производство или разработка единичного прибора.

В нашем ассортименте представлены ведущие мировые производители активных и пассивных электронных компонентов.

Нашей специализацией является поставка электронной компонентной базы двойного назначения, продукции таких производителей как XILINX, Intel (ex.ALTERA), Vicor, Microchip, Texas Instruments, Analog Devices, Mini-Circuits, Amphenol, Glenair.

Сотрудничество с глобальными дистрибьюторами электронных компонентов, предоставляет возможность заказывать и получать с международных складов практически любой перечень компонентов в оптимальные для Вас сроки.

На всех этапах разработки и производства наши партнеры могут получить квалифицированную поддержку опытных инженеров.

Система менеджмента качества компании отвечает требованиям в соответствии с ГОСТ Р ИСО 9001, ГОСТ РВ 0015-002 и ЭС РД 009

Офис по работе с юридическими лицами:

105318, г.Москва, ул.Щербаковская д.3, офис 1107, 1118, ДЦ «Щербаковский»

Телефон: +7 495 668-12-70 (многоканальный)

Факс: +7 495 668-12-70 (доб.304)

E-mail: info@moschip.ru

Skype отдела продаж:

moschip.ru

moschip.ru_4

moschip.ru_6

moschip.ru_9