

# RFID System V680 Series

CSM\_V680 Series\_DS\_E\_1\_1

## RFID Systems with ISO/IEC 18000-3 (ISO/IEC15693) Compliance

- High-speed communications and highly reliable communications provided with an electromagnetic induction system and unique technology.
- Antennas and RF Tags with excellent environmental resistance.
- Wide line-up of ultra-compact, long-life RF Tags, with capacities from 1 to 32 kbytes.
- Visualizes the communications status for simple analysis of the operating environment.
- Complies with FCC Standards and R&TTE Directive.

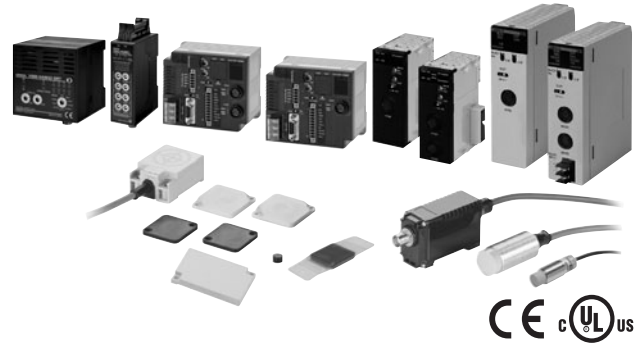

## System Configuration

Connect V680 Antennas and Amplifier Units to a V680-series Controller, and read or write data from or to RF Tags.

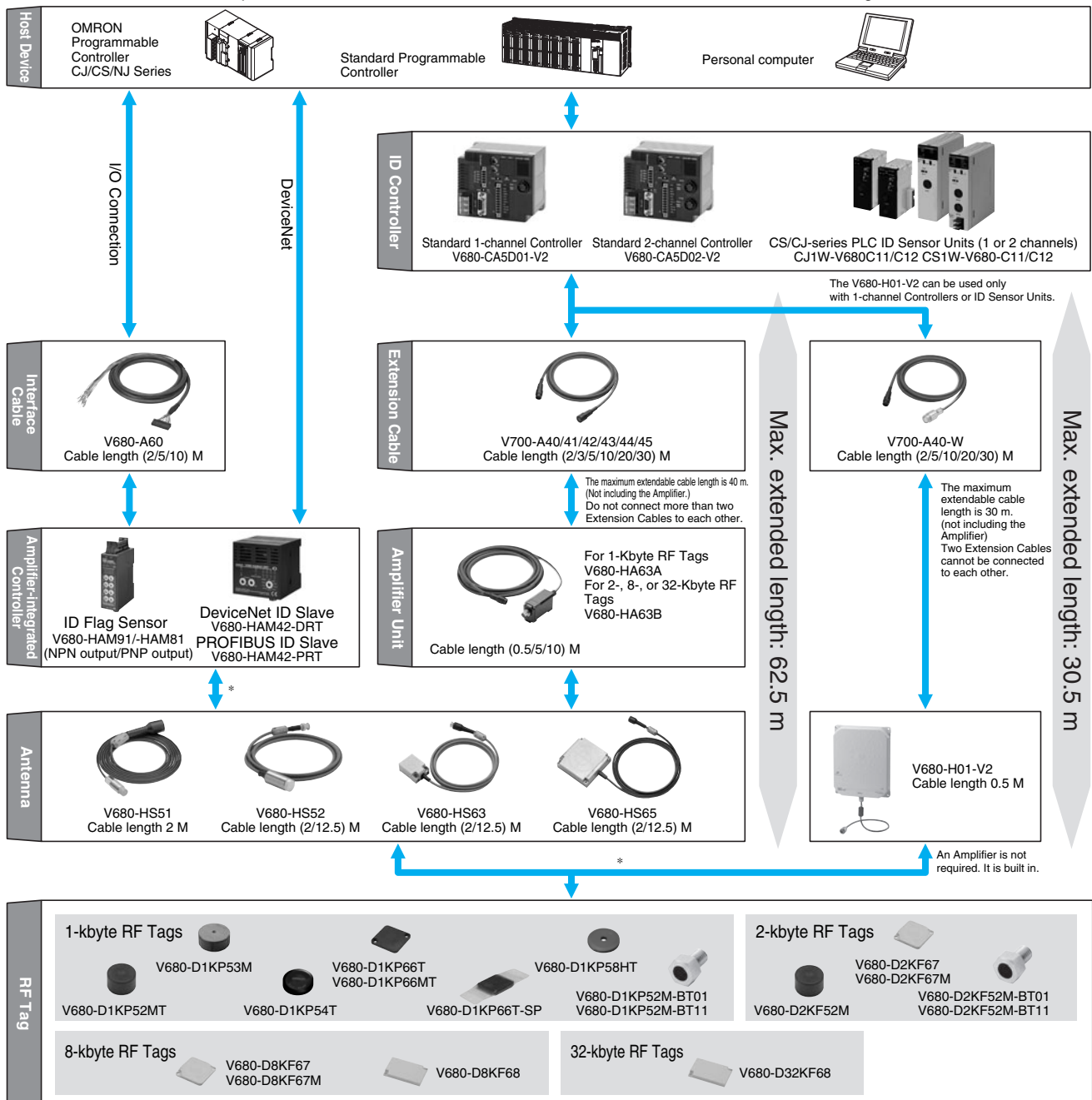

\* For information on the combinations that can be used, refer to *Combinations of Amplifier Units, Antennas, and RF Tags* on pages 2 to 3.

## Handheld Type

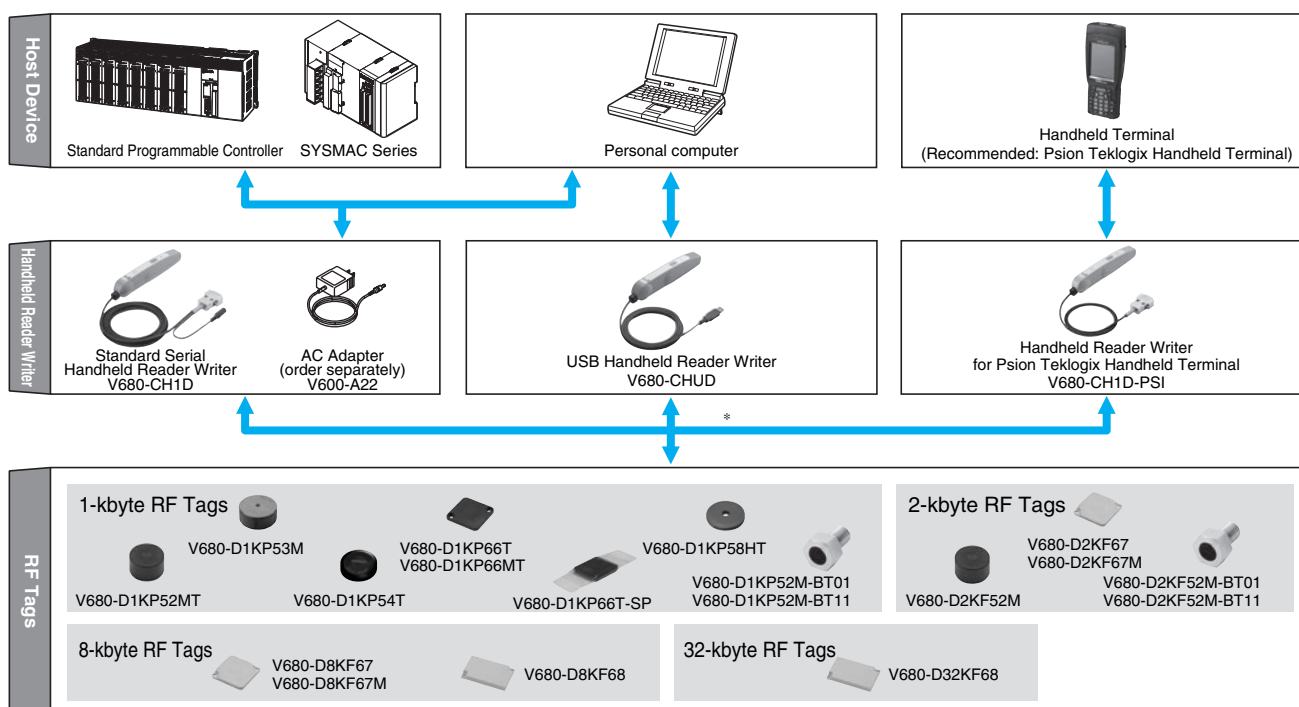

**Note:** Certification for radio wave regulations has been acquired for Japan, Europe, the USA, Canada, Mexico, Singapore, Malaysia, the Philippines, China, Taiwan, and Korea, for easy application overseas.  
 Contact your OMRON sales representative for details on whether application is supported in other countries.  
 The latest information on the status of certification for radio wave regulations in various countries can be confirmed on the OMRON website.





\* For information on the combinations that can be used, refer to *Combinations of Amplifier Units, Antennas, and RF Tags* on pages 2 to 3.

## Combinations of Amplifier Units, Antennas, and RF Tags



### 1-kbyte RF Tags

| Amplifier Unit                                | Antenna     | EEP-ROM       |              |              |              |               |                 |               |                   |
|---|-------------|---------------|--------------|--------------|--------------|---------------|-----------------|---------------|-------------------|
|   |             | 1-kbyte       |              |              |              |               |                 |               |                   |
|   |             | V680-D1KP52MT | V680-D1KP53M | V680-D1KP54T | V680-D1KP66T | V680-D1KP66MT | V680-D1KP66T-SP | V680-D1KP58HT | V680-D1KP52M-BT01 |
|   |             |               |              |              |              |               |                 |               |                   |
| V680-HA63A                                    | V680-HS51   | Yes           | Yes          |              |              |               |                 |               | Yes               |
| V680-HAM42-DRT                                | V680-HS52-□ | Yes           | Yes          | Yes          | Yes          | Yes           | Yes             | Yes           | Yes               |
| V680-HAM□1                                    | V680-HS63-□ | Yes*          |              | Yes          | Yes          | Yes           | Yes             |               |                   |
|   | V680-HS65-□ |               |              | Yes          | Yes          | Yes           | Yes             |               |                   |
| V680-HAM42-PRT                                | V680-HS63-W | Yes*          |              |              | Yes          | Yes           | Yes             |               |                   |
|   | V680-HS65-W |               |              |              | Yes          | Yes           | Yes             |               |                   |
| V680-H01-V2 (Antenna with Built-in Amplifier) |             |               |              |              | Yes          |               |                 | Yes           |                   |
| V680-CH□D (Handheld Reader Writer)            |             | Yes           | Yes          |              | Yes          | Yes           | Yes             | Yes           |                   |

## 2-kbyte RF Tags

| Amplifier Unit                                | Antenna     | FRAM  |  |   |  |
|---|-------------|---|--|---|--|
|   |             | 2-kbyte   |  |   |  |
|   |             | V680-D2KF52M<br> | V680-D2KF67<br> | V680-D2KF67M<br> | V680-D2KF52M-BT□1<br> |
| V680-HA63B<br>V680-HAM42-DRT<br>V680-HAM□1    | V680-HS51   | Yes   |  |   | Yes  |
|   | V680-HS52-□ | Yes   | Yes  | Yes   | Yes  |
|   | V680-HS63-□ | Yes*  | Yes  | Yes   |  |
|   | V680-HS65-□ |   | Yes  | Yes   |  |
| V680-HAM42-PRT                                | V680-HS63-W |   | Yes  | Yes   |  |
|   | V680-HS65-W |   | Yes  | Yes   |  |
| V680-H01-V2 (Antenna with Built-in Amplifier) |             |   | Yes  |   |  |
| V680-CH□D (Handheld Reader Writer)            |             | Yes   | Yes  | Yes   |  |

## 8-kbyte RF Tags

| Amplifier Unit                                | Antenna     | FRAM   |   |  |
|---|-------------|--|---|--|
|   |             | 8-kbyte  |   |  |
|   |             | V680-D8KF67<br> | V680-D8KF67M<br> | V680-D8KF68<br> |
| V680-HA63B<br>V680-HAM42-DRT<br>V680-HAM□1    | V680-HS51   |  |   |  |
|   | V680-HS52-□ | Yes  | Yes   |  |
|   | V680-HS63-□ | Yes  | Yes   | Yes  |
|   | V680-HS65-□ | Yes  | Yes   | Yes  |
| V680-HAM42-PRT                                | V680-HS63-W |  |   | Yes  |
|   | V680-HS65-W |  |   | Yes  |
| V680-H01-V2 (Antenna with Built-in Amplifier) |             | Yes  |   | Yes  |
| V680-CH□D (Handheld Reader Writer)            |             | Yes  | Yes   | Yes  |

## 32-kbyte RF Tags

| Amplifier Unit                                | Antenna     | FRAM  |
|---|-------------|---|
|   |             | 32-kbyte  |
|   |             | V680-D32KF68<br> |
| V680-HA63B<br>V680-HAM42-DRT<br>V680-HAM□1    | V680-HS51   |   |
|   | V680-HS52   |   |
|   | V680-HS63   | Yes   |
|   | V680-HS65   | Yes   |
| V680-HAM42-PRT                                | V680-HS63-W | Yes   |
|   | V680-HS65-W | Yes   |
| V680-H01-V2 (Antenna with Built-in Amplifier) |             | Yes   |
| V680-CH□D (Handheld Reader Writer)            |             | Yes   |

**Note:** For details, refer to the relevant user's manual (Z248, Z249, Z262, Z271, Z272, Z278, and Z279).

\* When using the V680-D1KP52MT or V680-D2KF52M embedded in metal, use the V680-HS51/-HS52 Antenna.













Communications will not be possible if the V680-HS63 Antenna is used.

Communications will not be possible if the V680-HS65 Antenna is used with the V680-D1KP52MT, V680-D1KP53M, or V680-D2KF52M.

Transmission is also possible with RF Tags other than those of the V680 Series as long as they comply with ISO/IEC 18000-3 (ISO/IEC 15693). However, transmission with RF Tags other than those of the V680 Series cannot be assured. The user must confirm transmission capabilities carefully prior to use.





## Ordering Information

## RF Tag

| Type         | Memory capacity   | Appearance  | Size                  | Metallic compatibility  | Model           |
|--------------|---|---|-----------------------|---|-----------------|
| Battery-less | 1 kbyte   |    | 8 dia. × 5 mm         | For embedding in metallic or non-metallic surface                                   | V680-D1KP52MT   |
|              |   |    | 10 dia. × 4.5 mm      | For embedding in metallic or non-metallic surface                                   | V680-D1KP53M    |
|              |   |    | 20 dia. × 2.7 mm      | For flush mounting on non-metallic surface  | V680-D1KP54T    |
|              |   |    | 34 × 34 × 3.5 mm      | For flush mounting on metallic surface  | V680-D1KP66MT   |
|              |   |   |                       | For flush mounting on non-metallic surface  | V680-D1KP66T    |
|              |   |    | 95 × 36.5 × 6.5 mm    | For flush mounting on non-metallic surface  | V680-D1KP66T-SP |
|              |   |    | 80 dia. × t10 mm      | For flush mounting on non-metallic surface  | V680-D1KP58HT   |
|              |  | M10 × 12 mm   | For mounting as bolts | V680-D1KP52M-BT01 *   |                 |
|              |   | M8 × 12 mm  |                       | V680-D1KP52M-BT11 *   |                 |
|              | 2 kbytes  |   | 8 dia. × 5 mm         | For embedding in metallic or non-metallic surface                                   | V680-D2KF52M    |
|              |   |   |                       | For flush mounting on metallic surface  | V680-D2KF67M    |
|              |   |  | 40 × 40 × 4.5 mm      | For flush mounting on non-metallic surface  | V680-D2KF67     |
|              |   |   |                       |  | M10 × 12 mm     |
|              | M8 × 12 mm  | V680-D2KF52M-BT11 *   |                       |   |                 |
|              | 8 kbytes  |  | 40 × 40 × 4.5 mm      | For flush mounting on metallic surface  | V680-D8KF67M    |
|              |   |   |                       | For flush mounting on non-metallic surface  | V680-D8KF67     |
|              | 32 kbytes   |  | 86 × 54 × 10 mm       | For flush mounting on non-metallic surface  | V680-D8KF68     |
|              |   |   |                       | V680-D32KF68  |                 |

\* Place orders in units of boxes (containing 20 units).

## Antenna (Detachable Amplifier Unit Type)



| Type   | Appearance  | Size              | Cable length      | Model             |                |
|--|---|-------------------|-------------------|-------------------|----------------|
| Cylindrical  | Standard cable, waterproof connector<br> | M22 × 65 mm       | 2 m               | V680-HS52-W 2M    |                |
|  |   |                   | 12.5 m            | V680-HS52-W 12.5M |                |
|  | Flexible cable, nonwaterproof connector   |                   | 2 m               | V680-HS52-R 2M    |                |
|  |   |                   | 12.5 m            | V680-HS52-R 12.5M |                |
| Standard cable, nonwaterproof connector<br> | M12 × 35 mm   | 2 m               | V680-HS51 2M      |                   |                |
| Square   | Standard cable, waterproof connector<br> | 40 × 53 × 23 mm   | 2 m               | V680-HS63-W 2M    |                |
|  |   |                   | 12.5 m            | V680-HS63-W 12.5M |                |
|  | Flexible cable, nonwaterproof connector   |                   | 2 m               | V680-HS63-R 2M    |                |
|  |   |                   | 12.5 m            | V680-HS63-R 12.5M |                |
|  | Standard cable, waterproof connector<br> |                   | 100 × 100 × 30 mm | 2 m               | V680-HS65-W 2M |
|  |   |                   | 12.5 m            | V680-HS65-W 12.5M |                |
| 2 m  |   | V680-HS65-R 2M    |                   |                   |                |
| Flexible cable, nonwaterproof connector  | 12.5 m  | V680-HS65-R 12.5M |                   |                   |                |

## Antenna with Built-in Amplifier



| Type   | Appearance   | Size              | Cable length | Model       |
|--------|--|-------------------|--------------|-------------|
| Square |  | 250 × 200 × 35 mm | 0.5 m *      | V680-H01-V2 |

\* Use an Antenna Cable to connect the Antenna to the Controller.  
The maximum cable length is 30.5 m.

## Amplifier Unit

| Type                      | Appearance  | Size            | Cable length | Model           |
|---------------------------|---|-----------------|--------------|-----------------|
| For 1-kbyte memory        |  | 25 × 40 × 65 mm | 0.5 m        | V680-HA63A 0.5M |
|                           |   |                 | 5 m          | V680-HA63A 5M   |
|                           |   |                 | 10 m         | V680-HA63A 10M  |
| For 2-/8-/32-kbyte memory |  |                 | 0.5 m        | V680-HA63B 0.5M |
|                           |   |                 | 5 m          | V680-HA63B 5M   |
|                           |   |                 | 10 m         | V680-HA63B 10M  |

## ID Controller

| Type            | No. of connectable Amplifiers | Appearance  | Size             | Transmission interface | Model          |
|-----------------|-------------------------------|---|------------------|------------------------|----------------|
| DC power supply | Single                        |  | 105 × 90 × 65 mm | RS232C,<br>RS422/RS485 | V680-CA5D01-V2 |
|                 | Dual                          |  |                  |                        | V680-CA5D02-V2 |

## ID Sensor Units

| Type                | Appearance  | Connected ID System |         | External power supply | No. of unit numbers used | Current consumption (A) |        |          | Model        |
|---------------------|---|---------------------|---------|-----------------------|--------------------------|-------------------------|--------|----------|--------------|
|                     |   |                     |         |                       |                          | 5 V                     | 24 V   | External |              |
| CJ Special I/O Unit |  | V680 Series         | 1 Head  | -                     | 1 unit number            | 0.26                    | 0.13 * | -        | CJ1W-V680C11 |
|                     |   |                     | 2 Heads |                       | 2 unit number            | 0.32                    | 0.26   | -        | CJ1W-V680C12 |



| Type                | Appearance  | Connected ID System |         | External power supply | No. of unit numbers used | Current consumption (A) |        |          | Model        |
|---------------------|---|---------------------|---------|-----------------------|--------------------------|-------------------------|--------|----------|--------------|
|                     |   |                     |         |                       |                          | 5 V                     | 26 V   | External |              |
| CS Special I/O Unit |  | V680 Series         | 1 Head  | -                     | 1 unit number            | 0.26                    | 0.13 * | -        | CS1W-V680C11 |
|                     |   |                     | 2 Heads |                       | 24 VDC                   | 2 unit number           | 0.32   | -        | 0.36         |

\* When connected to the V680-H01: 0.28 A

## Amplifier-integrated Controller (DeviceNet ID Slave/PROFIBUS ID Slave)

| Appearance  | Size            | Network Compatibility | Model          |
|---|-----------------|-----------------------|----------------|
|  | 65 × 65 × 65 mm | DeviceNet             | V680-HAM42-DRT |
|   |                 | PROFIBUS              | V680-HAM42-PRT |

## Amplifier-integrated Controllers (ID Flag Sensors)

| Type       | Appearance  | Size            | Model      |
|------------|---|-----------------|------------|
| NPN output |  | 90 × 30 × 65 mm | V680-HAM91 |
| PNP output |  |                 | V680-HAM81 |

## Special Interface Cables (for V680-HAM91 and V680-HAM81)

| Cable length | Model        | Appearance  |
|--------------|--------------|---|
| 2 m          | V680-A60 2M  |  |
| 5 m          | V680-A60 5M  |   |
| 10 m         | V680-A60 10M |   |

**Note:** 1. The connectors are not waterproof.

2. The cable length can be extended to a maximum of 10 m.





3. Normally two Interface Cables are required for 1 Unit. If you do not need to write to ID Tags, or use the address shift or noise check functions, then one Interface Cable is sufficient.

## Handheld Reader Writers

| Name  | Appearance  | Model          |
|---|---|----------------|
| Model with standard serial connector        |  | V680-CH1D      |
| Model with USB connector and 0.8-m cable    |   | V680-CHUD 0.8M |
| Model with USB connector and 1.9-m cable    |   | V680-CHUD 1.9M |
| Models for Psion Teklogix Handheld Terminal |   | V680-CH1D-PSI  |
| AC Adapter (for V680-CH1D)                  |   | V600-A22       |

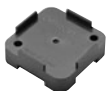
## Accessories (Order Separately)

### RF Tag Attachment

| Type                       | Appearance  | Model    |
|----------------------------|---|----------|
| For the V680-D1KP66T       |  | V600-A86 |
| For the V680-D□KF68        |  | V680-A81 |
| To mount the V680-D1KP58HT |  | V680-A80 |
| For the V680-D1KP54T       |  | V700-A80 |

### Amplifier Unit Special Extension Cable (Amplifier Unit to Controller)

| Cable length | Appearance   | Model        |
|--------------|--|--------------|
| 2 m          |  | V700-A40 2M  |
| 3 m          |  | V700-A41 3M  |
| 5 m          |  | V700-A42 5M  |
| 10 m         |  | V700-A43 10M |
| 20 m         |  | V700-A44 20M |
| 30 m         |  | V700-A45 30M |

**Note:** The cable can be extended up to 40 m. Up to two extension cables can be used.

### V680-H01 Antenna Special Cable (Antenna to Controller)

| Cable length | Appearance  | Model          |
|--------------|---|----------------|
| 2 m          |  | V700-A40-W 2M  |
| 5 m          |   | V700-A40-W 5M  |
| 10 m         |   | V700-A40-W 10M |
| 20 m         |   | V700-A40-W 20M |
| 30 m         |   | V700-A40-W 30M |

**Note:** The cable can be extended up to 30 m. Only one extension cable can be used.

### RS-232C Communications Connector

| Name           | Model         |
|----------------|---------------|
| Connector Plug | XM3B-0922-111 |
| Connector Hood | XM2S-0911     |

\* An RS422/RS485 Communications Connector is attached to the Controller.

### ID Map Manager (for Windows XP)

| Type            | Model            |
|-----------------|------------------|
| English version | V680-A-IMMEG-P01 |

## Psion Teklogix Handheld Terminals

We recommend connecting the V680/V680-CH-PSI Handheld Reader Writer to a Psion Teklogix WORKABOUT PRO-series Handheld Terminal. Psion Teklogix products can be purchased directly from OMRON.

### Handheld Terminal Set

| Name                               | Configuration  | OMRON model number          |
|------------------------------------|--|-----------------------------|
| Handheld Terminal Set (English OS) | Handheld Terminal, Serial End Cap, hand strap, charger (standard model), and High-capacity Battery | <b>V680-A-7527S-G3-EG-S</b> |

\* The Handheld Terminal Set includes the V600/V680 EasyAccess/CBAAccess Demo Software preinstalled in a 7527S-G3 Psion Teklogix Handheld Terminal and the configuration parts listed above.

### Handheld Terminal Only

| Name                           | Configuration  | Appearance  | OMRON model number        |
|--------------------------------|--|---|---------------------------|
| Handheld Terminal (English OS) | Handheld Terminal, Serial End Cap, and hand strap (Battery sold separately.) |  | <b>V680-A-7527S-G3-EG</b> |

\* The Handheld Terminal includes the V600/V680 EasyAccess/CBAAccess Demo Software preinstalled in a 7527S-G3 Psion Teklogix Handheld Terminal and the configuration parts listed above. The High-capacity Battery is not included.

### Handheld Terminal Accessories

| Name                     | Appearance  | Psion Teklogix model number | OMRON model number   |
|--------------------------|---|-----------------------------|----------------------|
| High-capacity Battery    |    | <b>WA3006</b>               | <b>V680-A-WA3006</b> |
| Charger (standard model) |  | <b>PS1050-G1</b>            | <b>V680-A-CA1053</b> |
| Charger (advanced model) |  | <b>WA4003-G2</b>            | <b>V680-A-WA4003</b> |
| Carrying Case            |  | <b>WA6197-G2</b>            | <b>V680-A-WA6197</b> |

Refer to the following website for detailed information on Psion Teklogix Handheld Terminals.

<http://www.pSIONteklogix.com/products/handheld/workaboutpro.htm>



## Ratings and Performance

### RF Tag (1-kbyte Memory)

| Item  | Model | V680-D1KP52MT   | V680-D1KP54T       | V680-D1KP66T     | V680-D1KP66MT | V680-D1KP53M                            | V680-D1KP66T-SP                            |
|---|-------|---|--------------------|------------------|---------------|---|--|
| Memory capacity                                     |       | 1,000 byte (user area)  |                    |                  |               |   |  |
| Memory type   |       | EEPROM  |                    |                  |               |   |  |
| Data retention time *1                              |       | 10 years after writing (85°C max.)  |                    |                  |               |   |  |
| Write endurance                                     |       | 100,000 times per block (at 25°C)   |                    |                  |               |   |  |
| Ambient operating temperature (during transmission) |       | -25 to 85°C (with no icing)   |                    |                  |               |   | -25 to 70°C (with no icing)                |
| Ambient storage temperature (during data backup)    |       | -40 to 125°C (with no icing)<br>Heat resistance: 1,000 thermal cycles each of 30 minutes at -10°C/150°C, High-temperature storage: 1,000 hours at 150°C *2<br>200 thermal cycles each of 30 minutes at -10°C/180°C, High-temperature storage: 200 hours at 180°C *3 |                    |                  |               | -40 to 125°C (with no icing)            | -40 to 110°C (with no icing)               |
| Ambient operating humidity                          |       | 35 to 95%   |                    |                  |               |   |  |
| Degree of protection                                |       | IEC 60529, IP68<br>In-house standard for antenna oil resistance (former JEM1030 standard equivalent to IP67g) *4  |                    |                  |               |   | IP67                                       |
| Vibration resistance                                |       | 10 to 2,000 Hz, 1.5-mm double amplitude at 150 m/s <sup>2</sup> acceleration with 10 sweeps in X, Y, and Z directions for 15 minutes each   |                    |                  |               |   |  |
| Shock resistance                                    |       | 500 m/s <sup>2</sup> in X, Y, and Z directions 3 times each (18 times in total)   |                    |                  |               |   |  |
| Appearance  |       | 8 dia. × 5 mm   | 20 dia. × 2.7 mm   | 34 × 34 × 3.5 mm |               | 10 dia. × 4.5 mm (DIN698373)            | 95 × 36.5 × 6.5 mm (excluding protrusions) |
| Materials   |       | Case: PPS resin<br>Filling: Epoxy resin   | Molding: PPS resin |                  |               | Case: PPS resin<br>Filling: Epoxy resin | External resin: PFA<br>Tag body: PPS resin |
| Weight  |       | Approx. 0.5 g   | Approx. 2 g        | Approx. 6 g      | Approx. 7.5 g | Approx. 1 g                             | Approx. 20 g                               |
| Metallic compatibility                              |       | Yes   | No                 | No               | Yes           | Yes                                     | No   |

**Note:** For details, refer to the User's Manual (Cat. No. Z262).

\*1. Refer to the User's Manual (Cat. No. Z262) for data retention time for temperatures of 85°C or higher. If the V680 has been stored at 125°C or higher, write the data again even if the data does not need to be changed.

\*2. 150°C heat resistance: The heat resistance has been checked at 150°C for up to 1,000 hours, and thermal shock has been checked through testing 1,000 thermal cycles each of 30 minutes at -10/150°C. (Test samples: 22, defects: 0)

\*3. 180°C heat resistance: The heat resistance has been checked at 180°C for up to 200 hours, and thermal shock has been checked through testing 200 thermal cycles each of 30 minutes at -10°C/180°C. (Test samples: 22, defects: 0)

\*4. This OMRON in-house standard confirms resistance to cutting and other oils. It is equivalent to the former JEM1030 standard.

### RF Tag with 1-kbyte Memory with High-temperature Capability

| Item  | Model | V680-D1KP58HT  |
|---|-------|--|
| Memory capacity                                     |       | 1,000 bytes (user area)  |
| Memory type   |       | EEPROM   |
| Data retention time                                 |       | 10 years after writing *   |
| Write endurance                                     |       | 100,000 times per block (at 25°C)  |
| Ambient operating temperature (during transmission) |       | -10 to 85°C (with no icing)  |
| Ambient storage temperature (during data backup)    |       | -40 to 110°C (with no icing)<br>Heat resistance: 2,000 thermal cycles each of 30 minutes at room temperature/200°C (Refer to Heat Resistance, below, for details.) |
| Ambient operating humidity                          |       | No limits.   |
| Degree of protection                                |       | IEC 60529, IP67  |
| Vibration resistance                                |       | 10 to 2,000 Hz, 1.5-mm double amplitude at 150 m/s <sup>2</sup> acceleration with 10 sweeps in X, Y, and Z directions for 15 minutes each                          |
| Shock resistance                                    |       | 500 m/s <sup>2</sup> in X, Y, and Z directions 3 times each (18 times in total)  |
| Materials   |       | PPS resin  |
| Weight  |       | Approx. 90 g   |

\* The data retention time at high temperatures (110 to 200°C) is 10 hours. Rewrite the data before 10 hours has lapsed.

### Heat Resistance

Sufficient heat resistance has been confirmed by evaluation testing comprising 2,000 thermal cycles each of 30 minutes at room temperature/200°C. The lifetime of the V680-D1KP58HT is affected by high-temperature storage, due to the effects of high temperatures on internal components. For details on the relationship between heat resistance and lifetime, refer to the User's Manual (Cat. No. Z262).

## RF Tag (2-kbyte Memory)

| Item                          | Model | V680-D2KF52M  | V680-D2KF67                                | V680-D2KF67M |
|-------------------------------|-------|---|--|--------------|
| Memory capacity               |       | 2,000 bytes (user area)   |  |              |
| Memory type                   |       | FRAM  |  |              |
| Data retention time *1        |       | 10 years after writing (55°C max.)  |  |              |
| Write endurance               |       | Access frequency per block *2: 10 billion times   |  |              |
| Ambient operating temperature |       | -25 to 85°C (with no icing)   |  |              |
| Ambient storage temperature   |       | -40 to 85°C (with no icing)   |  |              |
| Ambient operating humidity    |       | 35 to 95%   | 35 to 85%                                  |              |
| Degree of protection          |       | IEC 60529, IP67<br>In-house standard for antenna oil resistance (former JEM1030 standard equivalent to IP67g) *3                          |  |              |
| Vibration resistance          |       | 10 to 2,000 Hz, 1.5-mm double amplitude at 150 m/s <sup>2</sup> acceleration with 10 sweeps in X, Y, and Z directions for 15 minutes each |  |              |
| Shock resistance              |       | 500 m/s <sup>2</sup> in X, Y, and Z directions 3 times each (18 times in total)   |  |              |
| Appearance                    |       | 8 dia. × 5 mm   | 40 × 40 × 4.5 mm                           |              |
| Materials                     |       | Case: PPS resin<br>Filling: Epoxy resin   | Molding: PBT resin<br>Filling: Epoxy resin |              |
| Weight                        |       | Approx. 0.5 g   | Approx. 6.5 g                              | Approx. 7 g  |
| Metallic compatibility        |       | Yes   | No   | Yes          |

**Note:** For details, refer to the User's Manual (Cat. No. Z248).

\*1. Refer to the User's Manual (Cat. No. Z248) for data retention time for temperatures of 55°C or higher.

\*2. The total Read or Write communication frequency is called the access frequency.

\*3. This OMRON in-house standard confirms resistance to cutting and other oils. It is equivalent to the former JEM1030 standard.

## RF Tag with 8-/32-kbyte Memory

| Item                          | Model | V680-D8KF67   | V680-D8KF67M  | V680-D8KF68   | V680-D32KF68             |
|-------------------------------|-------|---|---------------|---|--------------------------|
| Memory capacity               |       | 8,192 bytes (user area)   |               |   | 32,744 bytes (user area) |
| Memory type                   |       | FRAM  |               |   |                          |
| Data retention time *1        |       | 10 years after writing (at 70°C max.)   |               |   |                          |
| Write endurance               |       | Access frequency per block *2: 10 billion times   |               |   |                          |
| Ambient operating temperature |       | -20 to 85°C (with no icing)   |               |   |                          |
| Ambient storage temperature   |       | -40 to 85°C (with no icing)   |               |   |                          |
| Ambient operating humidity    |       | 35 to 85%   |               |   |                          |
| Degree of protection          |       | IEC 60529, IP67<br>In-house standard for antenna oil resistance (former JEM1030 standard equivalent to IP67g) *3                          |               |   |                          |
| Vibration resistance          |       | 10 to 2,000 Hz, 1.5-mm double amplitude at 150 m/s <sup>2</sup> acceleration with 10 sweeps in X, Y, and Z directions for 15 minutes each |               | 10 to 500 Hz, 1.5-mm double amplitude at 100 m/s <sup>2</sup> acceleration with 10 sweeps in X, Y, and Z directions for 11 minutes each |                          |
| Shock resistance              |       | 500 m/s <sup>2</sup> in X, Y, and Z directions 3 times each (18 times in total)   |               |   |                          |
| Dimensions                    |       | 40 × 40 × 4.5 mm  |               | 86 × 54 × 10 mm   |                          |
| Materials                     |       | Case: PBT resin<br>Filling: Epoxy resin   |               |   |                          |
| Weight                        |       | Approx. 8 g   | Approx. 8.5 g | Approx. 50 g  |                          |
| Metallic compatibility        |       | No  | Yes           | No *4   |                          |

**Note:** For details, refer to the User's Manual (Cat. No. Z248).

\*1. Refer to the User's Manual (Cat. No. Z248) for data retention time for temperatures of 70°C or higher.

\*2. The total Read or Write communication frequency is called the access frequency.

\*3. This OMRON in-house standard confirms resistance to cutting and other oils. It is equivalent to the former JEM1030 standard.

\*4. Using the V680-A81 special attachment improves the influence of flush mounted on metallic surface.

**Bolt RF Tags (1-kbyte Memory)**

| Item  | Model | V680-D1KP52M-BT01   | V680-D1KP52M-BT11 |
|---|-------|---|-------------------|
| Memory capacity                                     |       | 1,000 bytes (user area)   |                   |
| Memory type   |       | EEPROM  |                   |
| Data retention time                                 |       | 10 years after writing (85°C max.)  |                   |
| Write endurance                                     |       | 100,000 times per block (at 25°C)   |                   |
| Ambient operating temperature (during transmission) |       | -25 to 85°C (with no icing)   |                   |
| Ambient storage temperature (during data backup)    |       | -40 to 125°C (with no icing)  |                   |
| Ambient operating humidity                          |       | 35 to 95%   |                   |
| Degree of protection                                |       | IP67 (IEC 60529 standard), In-house standard for oil resistance (Equivalent to former JEM standard IP67g.)                                |                   |
| Vibration resistance                                |       | 10 to 2,000 Hz, 1.5-mm double amplitude at 150 m/s <sup>2</sup> acceleration with 10 sweeps in X, Y, and Z directions for 15 minutes each |                   |
| Shock resistance                                    |       | 500 m/s <sup>2</sup> in X, Y, and Z directions 3 times each (18 times in total)   |                   |
| Materials   |       | Bolt: SUS303,<br>Case (RF Tag): PPS resin,<br>Filling (RF Tag): Epoxy resin   |                   |
| Weight  |       | Approx. 25 g  | Approx. 10 g      |

**Bolt RF Tags (2-kbyte Memory)**

| Item  | Model | V680-D2KF52M-BT01   | V680-D2KF52M-BT11 |
|---|-------|---|-------------------|
| Memory capacity                                     |       | 2,000 bytes (user area)   |                   |
| Memory type   |       | FRAM  |                   |
| Data retention time                                 |       | 10 years after writing (at 55°C max.)   |                   |
| Write endurance                                     |       | 10 billion reads/writes per block, Number of accesses*: 10 billion times  |                   |
| Ambient operating temperature (during transmission) |       | -25°C to 85°C (with no icing)   |                   |
| Ambient storage temperature (during data backup)    |       | -40°C to 85°C (with no icing)   |                   |
| Ambient operating humidity                          |       | 35 to 95%   |                   |
| Degree of protection                                |       | IEC 60529, IP67<br>In-house standard for antenna oil resistance (former JEM1030 standard equivalent to IP67g)                             |                   |
| Vibration resistance                                |       | 10 to 2,000 Hz, 1.5-mm double amplitude at 150 m/s <sup>2</sup> acceleration with 10 sweeps in X, Y, and Z directions for 15 minutes each |                   |
| Shock resistance                                    |       | 500 m/s <sup>2</sup> in X, Y, and Z directions 3 times each (18 times in total)   |                   |
| Materials   |       | Bolt: SUS303,<br>Case (RF Tag): PPS resin,<br>Filling (RF Tag): Epoxy resin   |                   |
| Weight  |       | Approx. 25 g  | Approx. 10 g      |

\* The number of accesses is the total number of communications for reading or writing.

## Cylindrical Antenna (Detachable Amplifier Unit Type)

| Item                          | Model | V680-HS51 (Standard Cable, Non-waterproof Connector)  | V680-HS52-W (Standard Cable, Waterproof Connector)   | V680-HS52-R (Standard Cable, Non-waterproof Connector)   |
|-------------------------------|-------|---|--|--|
| Ambient operating temperature |       | -10°C to 60°C (with no icing)   |  |  |
| Ambient storage temperature   |       | -25°C to 75°C (with no icing)   |  |  |
| Ambient operating humidity    |       | 35% to 95% (with no condensation)   |  |  |
| Insulation resistance         |       | 20 MΩ min. (at 500 VDC) between the cable terminals and the case  |  |  |
| Dielectric strength           |       | 1,000 VAC (50/60 Hz) for 1 minute between the cable terminals and the case with a current leakage of 5 mA max.  |  |  |
| Degree of protection          |       | IP67 (IEC60529)<br>In-house standard for antenna oil resistance (former JEM1030 standard equivalent to IP67g) (Antenna portion) *2                            | IP67 (IEC60529)<br>In-house standard for antenna oil resistance (former JEM1030 standard equivalent to IP67g) (Antenna portion) *1                         | IP67 (IEC60529)<br>In-house standard for antenna oil resistance (former JEM1030 standard equivalent to IP67g) (Antenna portion) *2 |
| Vibration resistance          |       | 10 to 2,000 Hz variable vibration, 1.5-mm double amplitude at 150 m/s <sup>2</sup> acceleration, with 10 sweeps in X, Y, and Z directions for 15 minutes each | 10 to 500 Hz variable vibration, 1.5-mm double amplitude at 100 m/s <sup>2</sup> acceleration, with 10 sweeps in X, Y, and Z directions for 8 minutes each |  |
| Shock resistance              |       | 1,000 m/s <sup>2</sup> in X, Y, and Z directions 3 times each (18 times in total)   | 500 m/s <sup>2</sup> in X, Y, and Z directions 3 times each (18 times in total)  |  |
| Appearance                    |       | M12 × 35 mm   | M22 × 65 mm  |  |
| Materials                     |       | ABS, brass, epoxy resin filling   |  |  |
| Weight                        |       | Approx. 55 g (with 2-m cable)   | Approx. 850 g (with 12.5-m cable)  |  |

**Note:** For details, refer to the User's Manual (Cat. No. Z248 or Z262).

\*1. The degree of protection for the Connector is IP67/IP65. This OMRON in-house standard confirms resistance to cutting and other oils. It is equivalent to the former JEM1030 standard.

\*2. The Connector is not waterproof. This OMRON in-house standard confirms resistance to cutting and other oils. It is equivalent to the former JEM1030 standard.

## Square Antenna (Detachable Amplifier Unit Type)

| Item                          | Model | V680-HS63-W (Standard Cable, Waterproof Connector)  | V680-HS63-R (Flexible Cable, Non-waterproof Connector)   |
|-------------------------------|-------|---|--|
| Ambient operating temperature |       | -10°C to 60°C (with no icing)   |  |
| Ambient storage temperature   |       | -25°C to 75°C (with no icing)   |  |
| Ambient operating humidity    |       | 35% to 95% (with no condensation)   |  |
| Insulation resistance         |       | 20 MΩ min. (at 500 VDC) between the cable terminals and the case  |  |
| Dielectric strength           |       | 1,000 VAC (50/60 Hz) for 1 minute between the cable terminals and the case with a current leakage of 5 mA max.  |  |
| Degree of protection          |       | IP67 (IEC60529)<br>In-house standard for antenna oil resistance (former JEM1030 standard equivalent to IP67g) (Antenna portion) *1                          | IP67 (IEC60529)<br>In-house standard for antenna oil resistance (former JEM1030 standard equivalent to IP67g) (Antenna portion) *2 |
| Vibration resistance          |       | 10 to 500 Hz variable vibration, 1.5-mm double amplitude at 100 m/s <sup>2</sup> acceleration, with 10 sweeps in X, Y, and Z directions for 11 minutes each |  |
| Shock resistance              |       | 500 m/s <sup>2</sup> in X, Y, and Z directions 3 times each (18 times in total)   |  |
| Appearance                    |       | 40 × 53 × 23 mm   |  |
| Materials                     |       | ABS, epoxy resin filling  |  |
| Weight                        |       | Approx. 850 g (with 12.5-m cable)   |  |

| Item                          | Model | V680-HS65-W (Standard Cable, Waterproof Connector)  | V680-HS65-R (Flexible Cable, Non-waterproof Connector)  |
|-------------------------------|-------|---|---|
| Ambient operating temperature |       | -25°C to 70°C (with no icing)   |   |
| Ambient storage temperature   |       | -40°C to 85°C (with no icing)   |   |
| Ambient operating humidity    |       | 35% to 95% (with no condensation)   |   |
| Insulation resistance         |       | 20 MΩ min. (at 500 VDC) between the cable terminals and the case  |   |
| Dielectric strength           |       | 1,000 VAC (50/60 Hz) for 1 minute between the cable terminals and the case with a current leakage of 5 mA max.  |   |
| Degree of protection          |       | IP67 (IEC 60529)<br>In-house standard for antenna oil resistance (former JEM1030 standard equivalent to IP67g) (Antenna portion) *1                         | IP67 (IEC 60529)<br>In-house standard for antenna oil resistance (former JEM1030 standard equivalent to IP67g) (Antenna portion) *2 |
| Vibration resistance          |       | 10 to 500 Hz variable vibration, 1.5-mm double amplitude at 100 m/s <sup>2</sup> acceleration, with 10 sweeps in X, Y, and Z directions for 11 minutes each |   |
| Shock resistance              |       | 500 m/s <sup>2</sup> in X, Y, and Z directions 3 times each (18 times in total)   |   |
| Appearance                    |       | 100 × 100 × 30 mm   |   |
| Materials                     |       | ABS, epoxy resin filling  |   |
| Weight                        |       | Approx. 1,100 g (with 12.5-m cable)   |   |

**Note:** For details, refer to the User's Manual (Cat. No. Z248 or Z262).

\*1. The degree of protection for the Connector is IP67/IP65. This OMRON in-house standard confirms resistance to cutting and other oils. It is equivalent to the former JEM1030 standard.

\*2. The Connector is not waterproof. This OMRON in-house standard confirms resistance to cutting and other oils. It is equivalent to the former JEM1030 standard.

## Square Antenna with Built-in Amplifier

| Item                          | Model | V680-H01-V2   |
|-------------------------------|-------|---|
| Ambient operating temperature |       | -10°C to 55°C (with no icing)   |
| Ambient storage temperature   |       | -35°C to 65°C (with no icing)   |
| Ambient operating humidity    |       | 35% to 85% (with no condensation)   |
| Insulation resistance         |       | 20 MΩ min. (at 100 VDC) between the back plate and the case   |
| Dielectric strength           |       | 1,000 VAC (50/60 Hz) for 1 minute between the back plate and the case with a current leakage of 1 mA max.   |
| Degree of protection          |       | IEC 60529: IP63 (Mounting direction: Transmission surface facing up)  |
| Vibration resistance          |       | 10 to 150 Hz variable vibration, 0.7-mm double amplitude and 50 m/s <sup>2</sup> acceleration with 10 sweeps in X, Y, and Z directions for 8 minutes each |
| Shock resistance              |       | 150 m/s <sup>2</sup> in X, Y, and Z directions 3 times each   |
| Appearance                    |       | 200 × 250 × 40 mm   |
| Material                      |       | Polycarbonate (PC) resin, ASA resin / Rear Panel: Aluminum  |
| Weight                        |       | Approx. 900 g   |
| Cable length                  |       | 0.5 m   |

Note: For details, refer to the User's Manual (Cat. No. Z248 or Z262).

## Amplifier Unit

| Item                          | Model | V680-HA63A  | V680-HA63B              |
|-------------------------------|-------|---|-------------------------|
| Ambient operating temperature |       | -10°C to 55°C (with no icing)   |                         |
| Ambient storage temperature   |       | -25°C to 65°C (with no icing)   |                         |
| Ambient operating humidity    |       | 35% to 85% (with no condensation)   |                         |
| Insulation resistance         |       | 20 MΩ min. (at 500 VDC) between the cable terminals and the case  |                         |
| Dielectric strength           |       | 1,000 VAC (50/60 Hz) for 1 minute between the cable terminals and the case with a current leakage of 5 mA max.  |                         |
| Degree of protection          |       | IP40 (IEC60529) *1  | IP67/IP65 (IEC60529) *2 |
| Vibration resistance          |       | 10 to 500 Hz variable vibration, 1.5-mm double amplitude at 100 m/s <sup>2</sup> acceleration, with 10 sweeps in X, Y, and Z directions for 11 minutes each |                         |
| Shock resistance              |       | 500 m/s <sup>2</sup> in X, Y, and Z directions 3 times each (18 times in total)   |                         |
| Appearance                    |       | 25 × 40 × 65mm (not including projections)  |                         |
| Material                      |       | Polycarbonate (PC) resin  |                         |
| Weight                        |       | Approx. 650 g (with 10-m cable)   |                         |
| Cable length                  |       | 5 m, 10 m   |                         |
| Transmittable RF Tags         |       | 1-kbyte memory  | 2-, 8-, 32-kbyte memory |

Note: For details, refer to the User's Manual (Cat. No. Z248 or Z262).

\*1. When connected to the V680-HS□□-R or V680-HS52-R.

\*2. When connected to the V680-HS□□-W or V680-HS52-W. (Not including the Connector on the Controller.)

## ID Controller

| Item  | Model | V680-CA5D01-V2  | V680-CA5D02-V2 |
|---|-------|---|----------------|
| Power supply voltage (Power consumption)  |       | 24 VDC (-15% to +10%)<br>15 W max., 0.8 A max.  |                |
| Communications Specifications   |       | RS-232C, RS-422, RS-485   |                |
| Input Specifications (Input voltage) RST, TRG1, and TRG2                                      |       | 24 VDC (+10% to -15%, including ripple) (PNP and NPN compatible)  |                |
| Output Specifications (Maximum switching capacity) RUN, BUSY/OUT3, ERROR/OUT4, OUT1, and OUT2 |       | 24 VDC (+10% to -15%, including ripple)<br>PNP and NPN compatible   |                |
| Ambient operating temperature   |       | -10 to 55°C (with no icing)   |                |
| Ambient storage temperature   |       | -25 to 65°C (with no icing)   |                |
| Ambient operating humidity  |       | 25% to 85% (with no condensation)   |                |
| Insulation resistance   |       | 20 MΩ min. (at 500 VDC) applied as follows:<br>(1) Between power supply terminals and grounded case<br>(2) Between ground and terminals                   |                |
| Dielectric strength   |       | 1,000 VAC (50/60 Hz) for 1 minute<br>(1) Between power supply terminals and grounded case<br>(2) Between ground and terminals                             |                |
| Degree of protection  |       | Panel mounted (equivalent to IP20)  |                |
| Vibration resistance  |       | 10 to 150 Hz variable vibration, 0.2-mm double amplitude at 15 m/s <sup>2</sup> acceleration, with 10 sweeps in X, Y, and Z directions for 8 minutes each |                |
| Shock resistance  |       | 150 m/s <sup>2</sup>  |                |
| Appearance  |       | 105 × 90 × 65 mm (not including projections)  |                |
| Material  |       | Polycarbonate (PC) resin, ABS resin   |                |
| Weight  |       | Approx. 300 g   |                |
| Connectable Amplifier Units   |       | 1   | 2              |

Note: For details, refer to the User's Manual (Cat. No. Z249).

## USB Port

The USB port is used for a simple connection with a personal computer using a USB cable. The port complies with USB 1.1, and the USB cable uses a series A or series mini-B connector. A USB port driver must be separately provided. Consult with your OMRON representative for details. When connected to a host device via USB, the communications will use 1:1 protocol regardless of the setting of DIP switches 3 to 9. The USB port is not used for control purposes. When building a system, be sure to provide an RS-232C port or RS-422/RS-485C port.

## ID Sensor Units

| Item                          | Model   | CJ1W-V680C11 | CJ1W-V680C12 | CS1W-V680C11                              | CS1W-V680C12 |
|-------------------------------|---|--------------|--------------|---|--------------|
| Current consumption           | Internal: 5 V   | 260 mA       | 320 mA       | 260 mA                                    | 320 mA       |
|                               | Internal: 24 V/26 V   | 130 mA *     | 260 mA       | 125 mA *                                  | –            |
|                               | External: 24 V  | –            | –            | –   | 360 mA       |
| Ambient operating temperature | 0 to 55°C   |              |              |   |              |
| Ambient storage temperature   | –20°C to 75°C   |              |              |   |              |
| Ambient operating humidity    | 10% to 90% (with no condensation)   |              |              |   |              |
| Insulation resistance         | 20 mΩ min. at 500 VDC   |              |              |   |              |
| Dielectric strength           | 1,000 VAC for 1 minute  |              |              |   |              |
| Degree of protection          | Mounted in panel (IP30)   |              |              |   |              |
| Vibration resistance          | 10 to 57 Hz variable vibration, 0.075-mm double amplitude and 57 to 150 Hz variable vibration at 9.8 m/s <sup>2</sup> acceleration, with 10 sweeps in X, Y, and Z directions for 8 minutes each |              |              |   |              |
| Shock resistance              | 147 m/s <sup>2</sup> in X, Y, and Z directions 3 times each   |              |              |   |              |
| Appearance                    | 31 × 65 × 90 mm (excluding protrusions)   |              |              | 35 × 130 × 101 mm (excluding protrusions) |              |

\* When connected to the V680-H01: 280 mA. The V680-H01-V2 can be connected only to a 1-channel ID Sensor Unit. A 2-channel Unit cannot be used.

## Functional Specifications of ID Sensor Units

| Item                            | Model   | CJ1W-V680C11 | CJ1W-V680C12 | CS1W-V680C11 | CS1W-V680C12 |
|---------------------------------|---|--------------|--------------|--------------|--------------|
| Communications control protocol | Special protocol for CS, CJ and NJ PLCs   |              |              |              |              |
| Number of Antenna connections   | 1   | 2            | 1            | 2            |              |
| Commands                        | Supported commands: Read, Write, Bit Set/Bit Clear, Mask Bit Write, Calculation Write, Data Fill, Data Check, Number of Writes Control, Copy (CJ1W-V680C12 and CS1W-V680C12 only), Read with Error Correction/Write with Error Correction, UID Read, and Noise Measurement.<br>The following communications options are supported: Single trigger, Single auto, Repeat auto, FIFO trigger, FIFO repeat *, Multi-access trigger, and Multi-access repeat * |              |              |              |              |
| Data transfer quantity          | 2,048 bytes max. (160 bytes/scan)   |              |              |              |              |
| Diagnostic function             | (1) CPU watchdog timer<br>(2) Communications error detection with RF Tag<br>(3) Antenna power supply error  |              |              |              |              |
| Monitoring/testing functions    | Tag communications can be tested in Test Mode. Status is displayed by LED indicators.   |              |              |              |              |
| Number of allocated words       | 10 words  | 20 words     | 10 words     | 20 words     |              |

**Note:** For details, refer to the User's Manual (Cat. No. Z271).

\* Cannot be used for communications with the V680-D1KP□□.

**Amplifier-integrated Controller (DeviceNet ID Slave/PROFIBUS ID Slave)**

| Item                          | Model | V680-HAM42-DRT   | V680-HAM42-PRT |
|-------------------------------|-------|--|----------------|
| Network compatibility         |       | DeviceNet  | PROFIBUS DP-V0 |
| Connectable Antennas          |       | One channel (V680-HS□□)  |                |
| Rated voltage                 |       | 24 VDC (–15% to 10%) including 10% ripple (p-p)  |                |
| Power consumption             |       | 4 W max. (Current consumption of 200 mA max. at power supply voltage of 24 VDC)  |                |
| Ambient operating temperature |       | –10 to 55°C (with no icing)  |                |
| Ambient storage temperature   |       | –25 to 65°C (with no icing)  |                |
| Ambient operating humidity    |       | 25% to 85% (with no condensation; ambient operating temperature is 40°C max. at humidity of 85%)                                     |                |
| Insulation resistance         |       | 20 MΩ min. (at 500 VDC) between all terminals excluding the ground terminal and the case   |                |
| Dielectric strength           |       | 1,000 VAC (50/60 Hz) for 1 minute between all terminals excluding the ground terminal and the case                                   |                |
| Vibration resistance          |       | 10 to 150 Hz, 0.2-mm double amplitude at 15 m/s <sup>2</sup> acceleration with 10 sweeps in X, Y and Z directions for 8 minutes each |                |
| Shock resistance              |       | 150 m/s <sup>2</sup> in X, Y, and Z directions 3 times each (18 times in total)  |                |
| Appearance                    |       | 65 × 65 × 65 mm (excluding protrusions)  |                |
| Degree of protection          |       | IEC 60529, IP20  |                |
| Materials                     |       | Polycarbonate (PC) resin, ABS resin  |                |
| Weight                        |       | Approx. 150 g  |                |
| Mounting                      |       | DIN Track  |                |

**Note: 1.** For details, refer to the *User's Manual* (Cat. No. Z278).

**2.** The number of words allocated in the master depends on the Access Mode.

**Amplifier-integrated Controllers (ID Flag Sensors)**

| Item                          | Model | V680-HAM91   | V680-HAM81  |
|-------------------------------|-------|--|---|
| Rated voltage                 |       | 24 VDC (–15% to +10%) including 10% ripple (p-p)   |   |
| Power consumption             |       | 3.5 W (24 VDC, 150 mA max. except external I/O line current)   |   |
| Input specifications          |       | Transistor output<br>Short-circuit current: 3 mA (typical) (for short-circuit between IN terminal and 0 V), OFF voltage: 15 to 30 VDC, ON voltage: 0 to 5 VDC, Input impedance: 8.2 kΩ, Applied voltage: 30 VDC max. |   |
| Output specifications         |       | NPN open-collector output 30 VDC, 20 mA max.,<br>Residual voltage: 2 V max.  | PNP open-collector output 30 VDC, 20 mA max.,<br>Residual voltage: 2 V max. |
| Ambient operating temperature |       | –10 to 55°C (with no icing)  |   |
| Ambient storage temperature   |       | –25 to 65°C (with no icing)  |   |
| Ambient operating humidity    |       | 25% to 85% (with no condensation; ambient operating temperature is 40°C max. at humidity of 85%)   |   |
| Insulation resistance         |       | 20 MΩ min. (at 500 VDC) between all terminals excluding the FG terminal and the case   |   |
| Dielectric strength           |       | 1,000 VAC (50/60 Hz) applied for 1 minute between all terminals excluding the FG terminal and the case   |   |
| Vibration resistance          |       | 10 to 150 Hz, 0.2-mm double amplitude at 15 m/s <sup>2</sup> acceleration with 10 sweeps in X, Y and Z directions for 8 minutes each   |   |
| Shock resistance              |       | 150 m/s <sup>2</sup> in X, Y, and Z directions 3 times each (18 times in total)  |   |
| Appearance                    |       | 90 × 30 × 65 mm (excluding protrusions)  |   |
| Degree of protection          |       | IEC 60529, IP40  |   |
| Materials                     |       | Polycarbonate (PC) resin, ABS resin  |   |
| Weight                        |       | Approx. 130 g  |   |
| Mounting                      |       | DIN Track  |   |

**Note: 1.** For details, refer to the *User's Manual* (Cat. No. Z279).

**2.** The connectors are not water resistant. If there is a possibility that water will be splashed onto the ID Sensor Unit, mount it inside of a control box. Also, be sure to use the V680 as a set with the V680-A60 Interface Cable (sold separately).

## Handheld Reader Writers

| Item   | Model | V680-CHUD 0.8M   | V680-CHUD 1.9M                                | V680-CH1D  | V680-CH1D-PSI                                 |
|--|-------|--|---|--|---|
| Power supply voltage                               |       | 5 VDC $\pm$ 5% (at the connector section of the product)   |   |  |   |
| Current consumption                                |       | 500 mA max. (for a power supply voltage of 5.0 V)  |   |  |   |
| Communications specifications                      |       | USB (Series A plug) Ver.1.1  |   | RS-232C (D-SUB 9-pin) compatible with IBM PC/AT) | RS-232C (D-SUB 9-pin)                         |
| Ambient operating temperature during communication |       | 0 to +40°C   |   |  |   |
| Ambient storage temperature                        |       | -25 to +65°C   |   |  |   |
| Ambient operating humidity during communication    |       | 35% to 85% (with no condensation)  |   |  |   |
| Insulation resistance                              |       | 50 M $\Omega$ min. (at 500 VDC) between connector and case   |   |  |   |
| Dielectric strength                                |       | 1,000 VAC, 50/60 Hz for 1 min (leakage current: 1 mA max.) between connectors and case   |   |  |   |
| Degree of protection                               |       | IEC 60529: IP63 *  |   |  |   |
| Vibration resistance                               |       | Destruction: 10 to 150 Hz variable vibration, 0.2-mm double amplitude and 15 m/s <sup>2</sup> acceleration with 10 sweeps for 8 min each in 6 directions |   |  |   |
| Shock resistance                                   |       | Destruction: 150 m/s <sup>2</sup> , 3 times each in X, Y, and Z directions   |   |  |   |
| Weight   |       | Approx. 110 g (including connector and cable)  | Approx. 140 g (including connector and cable) | Approx. 170 g (including connector and cable)    | Approx. 120 g (including connector and cable) |
| Cable length                                       |       | 0.8 m  | 1.9 m   | 2.5 m  | 0.8 m   |

**Note:** Refer to the User's Manual (Cat. No. Z272) for details.

Contact your OMRON sales representative for details on drivers for Windows.

\* This does not include the connector section. The main unit is not resistant to chemical or oils.













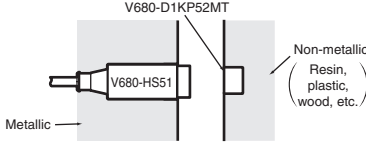

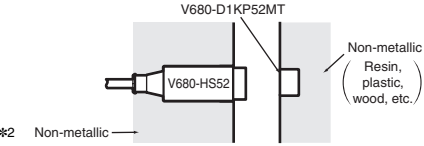

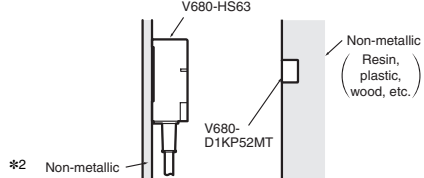

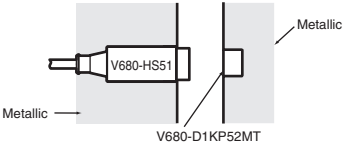
## AC Adapter (for V680-CH1D)

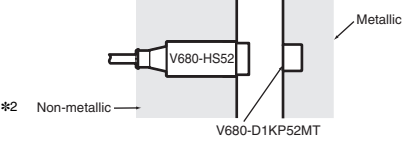
| Item                          | Model | V600-A22   |
|-------------------------------|-------|--|
| Input voltage                 |       | 100 to 120 VAC at 50/60 Hz   |
| Input current                 |       | AC: 300 mA (at load current of 2.0 A)  |
| Output voltage                |       | DC5V $\pm$ 0.25V   |
| Ambient operating temperature |       | 0 to +40°C   |
| Ambient storage temperature   |       | -20 to +85°C (with no icing)   |
| Ambient operating humidity    |       | 5% to 95% (with no condensation)   |
| Insulation resistance         |       | 100 M $\Omega$ min. (at 500 VDC) between input terminals and output terminals                          |
| Dielectric strength           |       | 2,000 V for 1 minute between input terminals and output terminals with a current leakage of 10 mA max. |
| Weight                        |       | Approx. 70 g   |
| Applicable standards          |       | UL   |

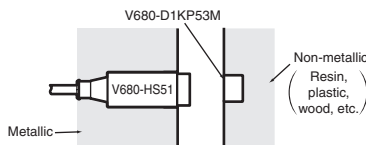

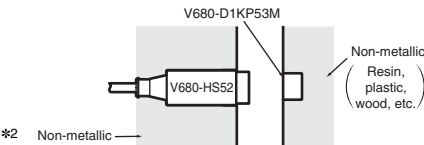

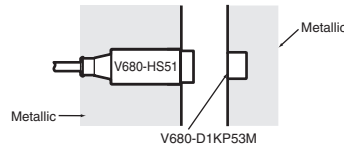

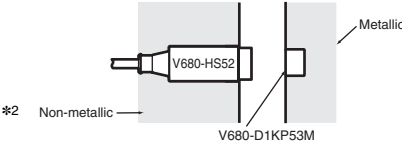







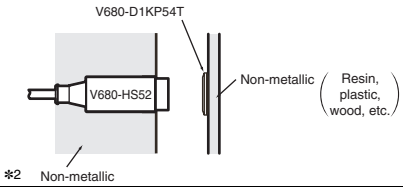

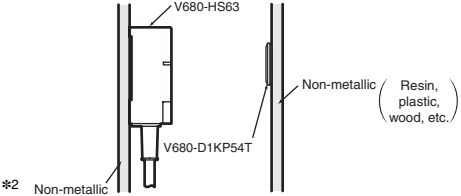
## Communication Specifications

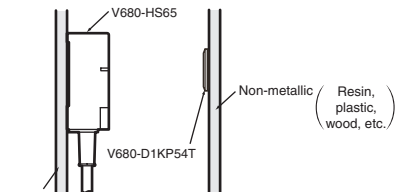
### ID Controllers (V680-CA5D01-V2/V680-CA5D02-V2) RF Tag (1-kbyte Memory) Transmission

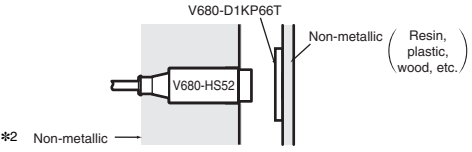
| Recommended combination  |   | Function       | Transmission distance (unit: mm)   | RF Tag and Antenna mounting conditions  |
|--|---|----------------|------------------------------------|---|
| RF Tag   | Antenna   |                |                                    |   |
|   | <b>V680-HS51</b><br>   | Read distance  | 0.5 to 6.5 (axial deviation ±2)    |    |
|  |   | Write distance | 0.5 to 6.0 (axial deviation ±2)    |   |
|  | <b>V680-HS52</b><br>   | Read distance  | 0 to 9.0 (axial deviation ±2)      |     |
|  |   | Write distance | 0 to 8.5 (axial deviation ±2)      |   |
|  | <b>V680-HS63</b><br>   | Read distance  | 0 to 12.0 (axial deviation ±2)     |     |
|  |   | Write distance | 0 to 9.5 (axial deviation ±2)      |   |
| <b>V680-D1KP52MT</b><br>(embedded in metallic surface: steel)<br> | <b>V680-HS51</b><br>  | Read distance  | 0.5 to 3.5 *1 (axial deviation ±2) |   |
|  |   | Write distance | 0.5 to 3.0 *1 (axial deviation ±2) |   |
|  | <b>V680-HS52</b><br> | Read distance  | 0 to 4.5 *1 (axial deviation ±2)   |   |
|  |   | Write distance | 0 to 4.0 *1 (axial deviation ±2)   |   |
| <b>V680-D1KP53M</b><br>   | <b>V680-HS51</b><br> | Read distance  | 0.5 to 6.5 (axial deviation ±2)    |  |
|  |   | Write distance | 0.5 to 6.0 (axial deviation ±2)    |   |
|  | <b>V680-HS52</b><br> | Read distance  | 0 to 9.0 (axial deviation ±2)      |   |
|  |   | Write distance | 0 to 8.5 (axial deviation ±2)      |   |
| <b>V680-D1KP53M</b><br>(embedded in metallic surface : steel)<br> | <b>V680-HS51</b><br> | Read distance  | 0.5 to 3.5 *1 (axial deviation ±2) |  |
|  |   | Write distance | 0.5 to 3.0 *1 (axial deviation ±2) |   |
|  | <b>V680-HS52</b><br> | Read distance  | 0 to 4.5 *1 (axial deviation ±2)   |   |
|  |   | Write distance | 0 to 4.0 *1 (axial deviation ±2)   |   |

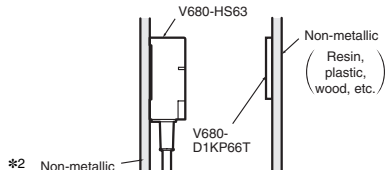
\*1. When using the V680-D1KP52MT/-D1KP53M embedded in metal, use the V680-HS51/-HS52 Antenna. Communications will not be possible with a V680-HS63 Antenna.

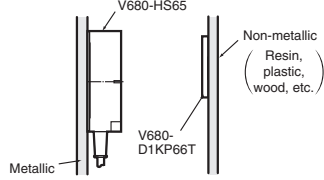

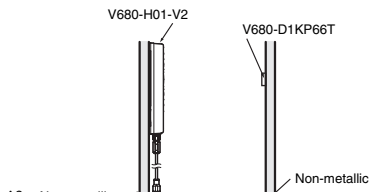





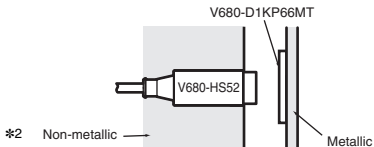

\*2. The Antenna can be mounted in metal, but the communications distance will decrease compared to mounting in nonmetal. Confirm performance using the actual devices before actual operation.

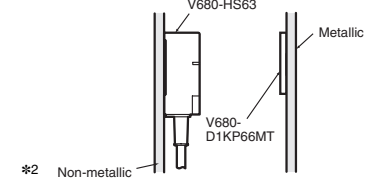
| Recommended combination  |   | Function       | Transmission distance (unit: mm)   | RF Tag and Antenna mounting conditions  |
|--|---|----------------|------------------------------------|---|
| RF Tag   | Antenna   |                |                                    |   |
| <b>V680-D1KP54T</b><br><br>   | <b>V680-HS52</b><br>     | Read distance  | 0 to 17.0 *1 (axial deviation ±2)  |    |
|  |   | Write distance | 0 to 15.0 *1 (axial deviation ±2)  |   |
|  | <b>V680-HS63</b><br>     | Read distance  | 0 to 24.0 *1 (axial deviation ±10) |     |
|  |   | Write distance | 0 to 20.0 *1 (axial deviation ±10) |   |
|  | <b>V680-HS65</b><br>     | Read distance  | 0 to 33.0 *1 (axial deviation ±10) |    |
|  |   | Write distance | 0 to 28.0 *1 (axial deviation ±10) |   |
| <b>V680-D1KP66T</b><br><br> | <b>V680-HS52</b><br>    | Read distance  | 0 to 17.0 *1 (axial deviation ±2)  |    |
|  |   | Write distance | 0 to 17.0 *1 (axial deviation ±2)  |   |
|  | <b>V680-HS63</b><br>   | Read distance  | 0 to 30.0 *1 (axial deviation ±10) |   |
|  |   | Write distance | 0 to 25.0 *1 (axial deviation ±10) |   |
|  | <b>V680-HS65</b><br>   | Read distance  | 0 to 47.0 *1 (axial deviation ±10) |  |
|  |   | Write distance | 0 to 42.0 *1 (axial deviation ±10) |   |
|  | <b>V680-H01-V2</b><br> | Read distance  | 0 to 100.0 *1 (axial deviation ±2) |   |
|  |   | Write distance | 0 to 100.0 *1 (axial deviation ±2) |   |

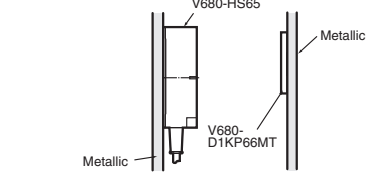
**Note:** When mounting the V680-HS65, be sure to attach the Mounting Brackets at the base of the Antenna. The enclosed Mounting Brackets do not need to be used, however, if the mounting brackets on the Antenna are metal plates and their dimensions are larger than the dimensions of the Antenna (100 × 100 mm). For details, refer to the User's Manual (Cat. No. Z248 or Z262).

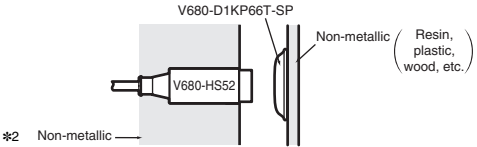
\*1. The transmission distance may be reduced if the V680-D1KP66T/-D1KP54T is mounted onto a metallic surface. Refer to the User's Manual (Cat. No. Z262) for details.

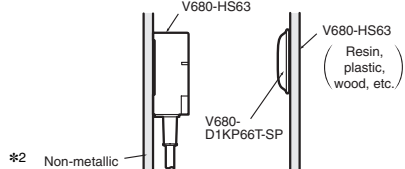
\*2. The Antenna can be mounted in metal, but the communications distance will decrease compared to mounting in nonmetal. Confirm performance using the actual devices before actual operation.

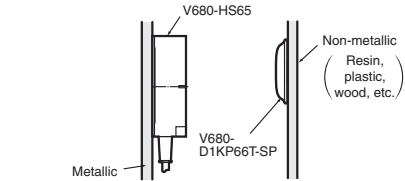
| Recommended combination  |  | Function  | Transmission distance (unit: mm)  | RF Tag and Antenna mounting conditions  |  |
|--|--|---|-----------------------------------|---|--|
| RF Tag   | Antenna  |   |                                   |   |  |
| <b>V680-D1KP66MT</b><br>(flush-mounted on metallic surface: steel) | <b>V680-HS52</b><br>  | Read distance   | 0 to 16.0 (axial deviation ±2)    |   |  |
|  |  | Write distance  | 0 to 14.0 (axial deviation ±2)    |   |  |
|  |                       | <b>V680-HS63</b><br>   | Read distance                     | 0 to 25.0 (axial deviation ±10)   |    |
|  |  |   | Write distance                    | 0 to 20.0 (axial deviation ±10)   |  |
|  |                       | <b>V680-HS65</b><br>   | Read distance                     | 0 to 25.0 (axial deviation ±10)   |    |
|  |  |   | Write distance                    | 0 to 20.0 (axial deviation ±10)   |  |
| <b>V680-D1KP66T-SP</b>   | <b>V680-HS52</b><br> | Read distance   | 0 to 15.0 *1 (axial deviation ±2) |  |  |
|  |  | Write distance  | 0 to 15.0 *1 (axial deviation ±2) |   |  |
|  |                     | <b>V680-HS63</b><br> | Read distance                     | 0 to 25.0 *1 (axial deviation ±10)  |  |
|  |  |   | Write distance                    | 0 to 20.0 *1 (axial deviation ±10)  |  |
|  |                     | <b>V680-HS65</b><br> | Read distance                     | 0 to 42.0 *1 (axial deviation ±10)  |  |
|  |  |   | Write distance                    | 0 to 37.0 *1 (axial deviation ±10)  |  |

**Note:** When mounting the V680-HS65, be sure to attach the Mounting Brackets at the base of the Antenna.  
 The enclosed Mounting Brackets do not need to be used, however, if the mounting brackets on the Antenna are metal plates and their dimensions are larger than the dimensions of the Antenna (100 × 100 mm).  
 For details, refer to the User's Manual (Cat. No. Z248 or Z262).

\*1. The transmission distance may be reduced if the V680-D1KP66T-SP is mounted onto a metallic surface. Refer to the User's Manual (Cat. No. Z262) for details.

\*2. The Antenna can be mounted in metal, but the communications distance will decrease compared to mounting in nonmetal. Confirm performance using the actual devices before actual operation.



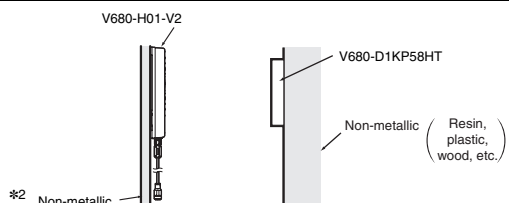









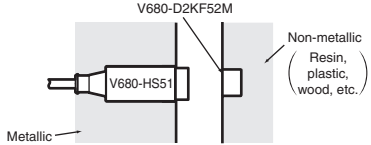

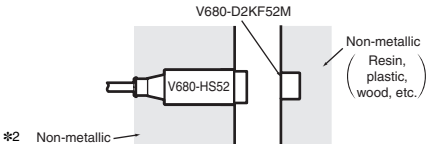

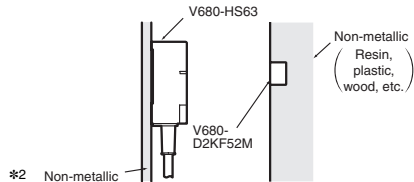

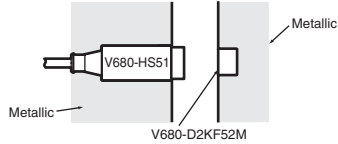
### High-temperature RF Tag (1-kbyte Memory) Transmission

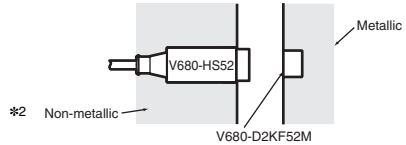
| Recommended combination |   | Function                            | Transmission distance (unit: mm)       | RF Tag and Antenna mounting conditions   |
|-------------------------|---|-------------------------------------|--|--|
| RF Tag                  | Antenna   |                                     |  |  |
| <b>V680-D1KP58HT</b>    | <b>V680-H01-V2</b><br> | Read distance<br><br>Write distance | 0 to 150.0 *1<br>(axial deviation ±10) |  |

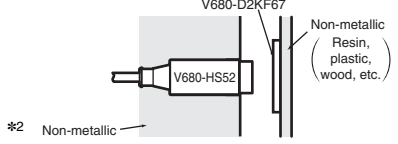
\*1. The transmission distance may be reduced if the V680-D1KP58HT is mounted onto a metallic surface. Refer to the User's Manual (Cat. No. Z262) for details.

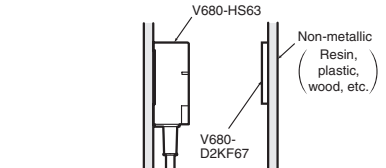
\*2. The Antenna can be mounted in metal, but the communications distance will decrease compared to mounting in nonmetal. Confirm performance using the actual devices before actual operation.

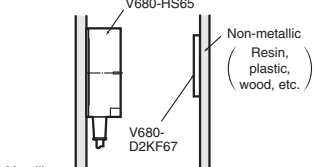
## RF Tag (2-kbyte Memory) Transmission

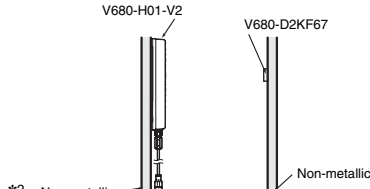
| Recommended combination  |   | Function       | Transmission distance (unit: mm)    | RF Tag and Antenna mounting conditions  |
|--|---|----------------|-------------------------------------|---|
| RF Tag   | Antenna   |                |                                     |   |
| <b>V680-D2KF52M</b><br><br>   | <b>V680-HS51</b><br>     | Read distance  | 0.5 to 5.5 (axial deviation ±2)     |    |
|  |   | Write distance | 0.5 to 5.5 (axial deviation ±2)     |   |
|  | <b>V680-HS52</b><br>     | Read distance  | 0 to 8.0 (axial deviation ±2)       |     |
|  |   | Write distance | 0 to 8.0 (axial deviation ±2)       |   |
|  | <b>V680-HS63</b><br>     | Read distance  | 0 to 9.5 (axial deviation ±2)       |    |
|  |   | Write distance | 0 to 9.5 (axial deviation ±2)       |   |
| <b>V680-D2KF52M</b><br>(embedded in metallic surface: steel)<br><br> | <b>V680-HS51</b><br>     | Read distance  | 0 to 3.5 (axial deviation ±2)       |    |
|  |   | Write distance | 0 to 3.5 (axial deviation ±2)       |   |
|  | <b>V680-HS52</b><br>   | Read distance  | 0 to 3.0 (axial deviation ±2)       |   |
|  |   | Write distance | 0 to 3.0 (axial deviation ±2)       |   |
| <b>V680-D2KF67</b><br><br>  | <b>V680-HS52</b><br>   | Read distance  | 0 to 17.0 *1 (axial deviation ±2)   |   |
|  |   | Write distance | 0 to 17.0 *1 (axial deviation ±2)   |   |
|  | <b>V680-HS63</b><br>   | Read distance  | 7 to 30.0 *1 (axial deviation ±10)  |  |
|  |   | Write distance | 7 to 30.0 *1 (axial deviation ±10)  |   |
|  | <b>V680-HS65</b><br>   | Read distance  | 0 to 42.0 *1 (axial deviation ±10)  |  |
|  |   | Write distance | 0 to 42.0 *1 (axial deviation ±10)  |   |
|  | <b>V680-H01-V2</b><br> | Read distance  | 0 to 100.0 *1 (axial deviation ±10) |  |
|  |   | Write distance | 0 to 100.0 *1 (axial deviation ±10) |   |





**Note:** When mounting the V680-HS65, be sure to attach the Mounting Brackets at the base of the Antenna.

The enclosed Mounting Brackets do not need to be used, however, if the mounting brackets on the Antenna are metal plates and their dimensions are larger than the dimensions of the Antenna (100 × 100 mm).

For details, refer to the User's Manual (Cat. No. Z248 or Z262).

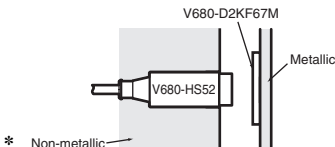
\*1. The transmission distance may be reduced if the V680-D2KF67 is mounted onto a metallic surface. Refer to the User's Manual (Cat. No. Z248) for details.

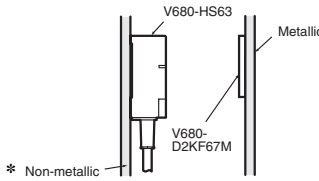

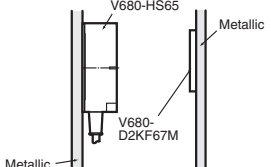





\*2. The Antenna can be mounted in metal, but the communications distance will decrease compared to mounting in nonmetal. Confirm performance using the actual devices before actual operation.

| Recommended combination   |  | Function       | Transmission distance (unit: mm) | RF Tag and Antenna mounting conditions  |
|---|--|----------------|----------------------------------|---|
| RF Tag  | Antenna  |                |                                  |   |
| <b>V680-D2KF67M</b><br>(flush-mounted on metallic surface: steel) | <b>V680-HS52</b>  | Read distance  | 0 to 16.0 (axial deviation ±2)   |  |
|   |  | Write distance | 0 to 16.0 (axial deviation ±2)   |   |
|   | <b>V680-HS63</b>  | Read distance  | 6 to 25.0 (axial deviation ±10)  |  |
|   |  | Write distance | 6 to 25.0 (axial deviation ±10)  |   |
|   | <b>V680-HS65</b>  | Read distance  | 0 to 25.0 (axial deviation ±10)  |  |
|   |  | Write distance | 0 to 25.0 (axial deviation ±10)  |   |

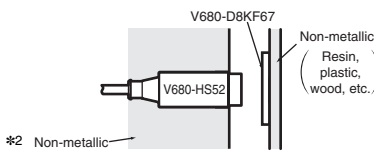
**Note:** When mounting the V680-HS65, be sure to attach the Mounting Brackets at the base of the Antenna. The enclosed Mounting Brackets do not need to be used, however, if the mounting brackets on the Antenna are metal plates and their dimensions are larger than the dimensions of the Antenna (100 × 100 mm). For details, refer to the User's Manual (Cat. No. Z248 or Z262).

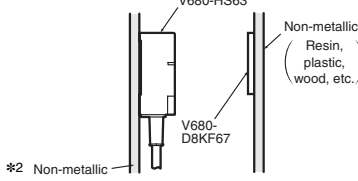
\* The Antenna can be mounted in metal, but the communications distance will decrease compared to mounting in nonmetal. Confirm performance using the actual devices before actual operation.

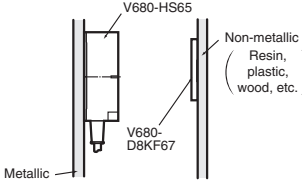

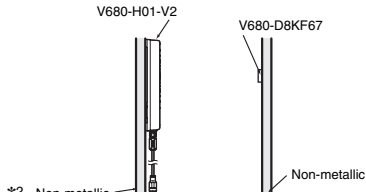







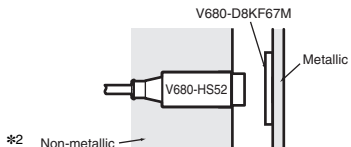

## RF Tag (8-/32-kbyte Memory) Transmission

| Recommended combination  |  | Function       | Transmission distance (unit: mm)    | RF Tag and Antenna mounting conditions  |
|--|--|----------------|-------------------------------------|---|
| RF Tag   | Antenna  |                |                                     |   |
| <b>V680-D8KF67</b>  | <b>V680-HS52</b>    | Read distance  | 0 to 17.0 *1 (axial deviation ±2)   |  |
|  |  | Write distance | 0 to 17.0 *1 (axial deviation ±2)   |   |
|  | <b>V680-HS63</b>    | Read distance  | 0 to 30.0 *1 (axial deviation ±10)  |  |
|  |  | Write distance | 0 to 30.0 *1 (axial deviation ±10)  |   |
|  | <b>V680-HS65</b>    | Read distance  | 0 to 42.0 *1 (axial deviation ±10)  |  |
|  |  | Write distance | 0 to 42.0 *1 (axial deviation ±10)  |   |
|  | <b>V680-H01-V2</b>  | Read distance  | 0 to 100.0 *1 (axial deviation ±10) |  |
|  |  | Write distance | 0 to 100.0 *1 (axial deviation ±10) |   |

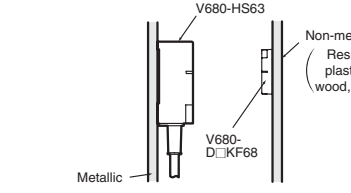
**Note:** When mounting the V680-HS65, be sure to attach the Mounting Brackets at the base of the Antenna. The enclosed Mounting Brackets do not need to be used, however, if the mounting brackets on the Antenna are metal plates and their dimensions are larger than the dimensions of the Antenna (100 × 100 mm). For details, refer to the User's Manual (Cat. No. Z248 or Z262).

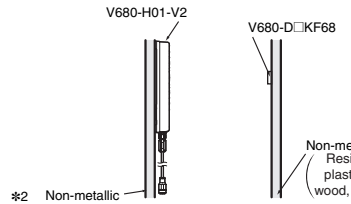
\*1. The communications distance will decrease if there is metal at the back of the V680-D8KF67. For details, refer to the relative user's manual (Cat. No. Z248).

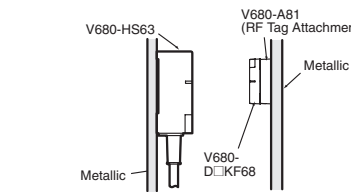
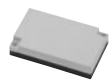
\*2. The Antenna can be mounted in metal, but the communications distance will decrease compared to mounting in nonmetal. Confirm performance using the actual devices before actual operation.

| Recommended combination   |   | Function  | Transmission distance (unit: mm)          | RF Tag and Antenna mounting conditions   |
|---|---|---|---|--|
| RF Tag  | Antenna   |   |   |  |
| <b>V680-D8KF67M</b><br>(flush-mounted on metallic surface: steel)   | <b>V680-HS52</b><br>     | Read distance   | 0 to 16.0 (axial deviation $\pm 2$ )      |    |
|   |   | Write distance  | 0 to 16.0 (axial deviation $\pm 2$ )      |  |
|   |                          | <b>V680-HS63</b><br>   | Read distance                             | 0 to 25.0 (axial deviation $\pm 10$ )  |
|   |   | Write distance  | 0 to 25.0 (axial deviation $\pm 10$ )     |  |
|   |   | <b>V680-HS65</b><br>   | Read distance                             | 0 to 25.0 (axial deviation $\pm 10$ )  |
|   | Write distance  | 0 to 25.0 (axial deviation $\pm 10$ )   |   |  |
| <b>V680-D8KF68/ -D32KF68</b><br> | <b>V680-HS63</b><br>    | Read distance   | 0 to 45.0 *1 (axial deviation $\pm 10$ )  |   |
|   |   | Write distance  | 0 to 45.0 *1 (axial deviation $\pm 10$ )  |  |
|   |   | <b>V680-HS65</b><br> | Read distance                             | 0 to 75.0 *1 (axial deviation $\pm 10$ )   |
|   | Write distance  | 0 to 75.0 *1 (axial deviation $\pm 10$ )  |   |  |
|   | <b>V680-H01-V2</b><br> | Read distance   | 0 to 150.0 *1 (axial deviation $\pm 10$ ) |  |
|   | Write distance  | 0 to 150.0 *1 (axial deviation $\pm 10$ )   |   |  |
| <b>V680-D8KF68/ -D32KF68</b><br>(Special attachment provided: flush-mounted on metallic surface: steel)             | <b>V680-HS63</b><br>   | Read distance   | 0 to 35.0 (axial deviation $\pm 10$ )     |  |
|   |   | Write distance  | 0 to 35.0 (axial deviation $\pm 10$ )     |  |
|   |                        | <b>V680-HS65</b><br> | Read distance                             | 0 to 55.0 (axial deviation $\pm 10$ )  |
|   |   | Write distance  | 0 to 55.0 (axial deviation $\pm 10$ )     |  |

**Note:** When mounting the V680-HS65, be sure to attach the Mounting Brackets at the base of the Antenna.









The enclosed Mounting Brackets do not need to be used, however, if the mounting brackets on the Antenna are metal plates and their dimensions are larger than the dimensions of the Antenna (100 × 100 mm).

For details, refer to the User's Manual (Cat. No. Z248 or Z262).

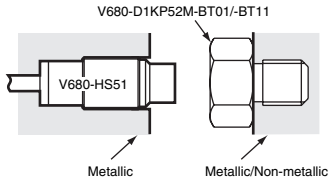
\*1. The transmission distance may be reduced if the V680-D8KF68 is mounted onto a metallic surface. Use V680-A81 special attachment. Refer to the User's Manual (Cat. No. Z248) for details.

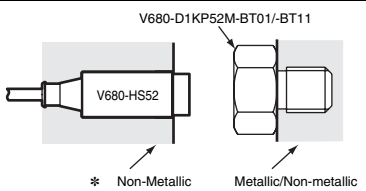

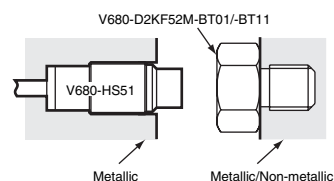

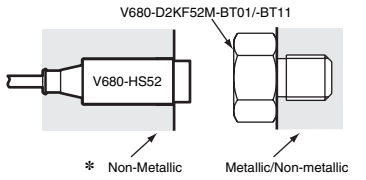
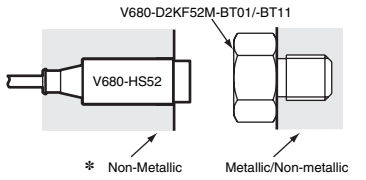







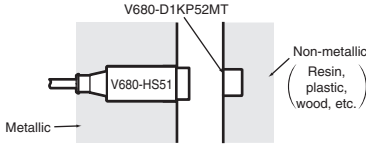

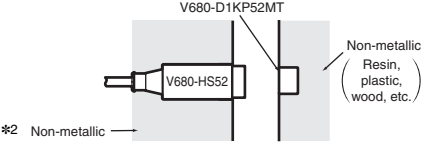

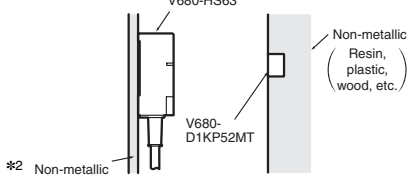

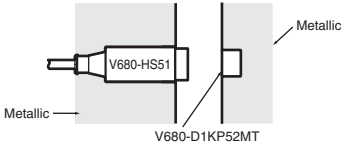
\*2. The Antenna can be mounted in metal, but the communications distance will decrease compared to mounting in nonmetal. Confirm performance using the actual devices before actual operation.

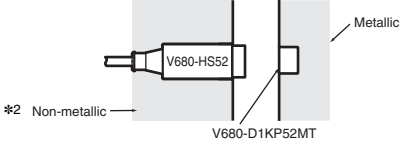
**Bolt RF Tag (1-kbyte or 2-kbyte Memory) Transmission**

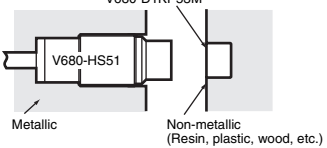

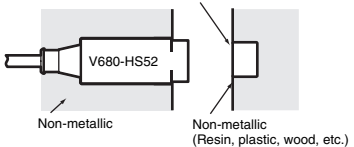

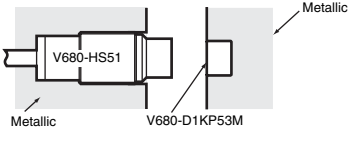

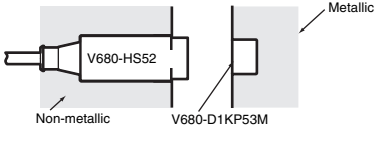
| Recommended combination   |  | Function       | Transmission distance (unit: mm) | RF Tag and Antenna mounting conditions   |
|---|--|----------------|----------------------------------|--|
| RF Tag  | Antenna  |                |                                  |  |
|  |   | Read distance  | 0.5 to 2.5 (axial deviation ±2)  |   |
|   |  | Write distance | 0.5 to 2.0 (axial deviation ±2)  |  |
|  |   | Read distance  | 0.5 to 3.0 (axial deviation ±2)  |   |
|   |  | Write distance | 0.5 to 2.5 (axial deviation ±2)  |  |
|  |   | Read distance  | 0.5 to 2.5 (axial deviation ±2)  |   |
|   |  | Write distance | 0.5 to 2.5 (axial deviation ±2)  |  |
|  |  | Read distance  | 0.5 to 2.0 (axial deviation ±2)  |  |
|   |  | Write distance | 0.5 to 2.0 (axial deviation ±2)  |  |

\* Mounting can be performed in metal, but the communications distance will decrease compared to mounting in nonmetal. Confirm performance using the actual devices before actual operation.

**DeviceNet ID Slave (V680-HAM42-DRT)  
 PROFIBUS ID Slave (V680-HAM42-PRT)  
 ID Flag Sensors (V680-HAM91/-HAM81)  
 RF Tag (1-kbyte Memory) Transmission**

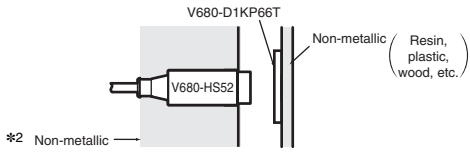
| Recommended combination  |   | Function       | Transmission distance (unit: mm) | RF Tag and Antenna mounting conditions  |
|--|---|----------------|----------------------------------|---|
| RF Tag   | Antenna   |                |                                  |   |
|   | <b>V680-HS51</b><br>   | Read distance  | 0.5 to 6.5 (axial deviation ±2)  |    |
|  |   | Write distance | 0.5 to 6.0 (axial deviation ±2)  |   |
|  | <b>V680-HS52</b><br>   | Read distance  | 0.5 to 9.0 (axial deviation ±2)  |     |
|  |   | Write distance | 0.5 to 8.5 (axial deviation ±2)  |   |
|  | <b>V680-HS63</b><br>   | Read distance  | 0.5 to 12.0 (axial deviation ±2) |     |
|  |   | Write distance | 0.5 to 9.5 (axial deviation ±2)  |   |
| <b>V680-D1KP52MT</b><br>(embedded in metallic surface: steel)<br> | <b>V680-HS51</b><br> | Read distance  | 0.5 to 3.5 (axial deviation ±2)  |   |
|  |   | Write distance | 0.5 to 3.0 (axial deviation ±2)  |   |
|  | <b>V680-HS52</b><br> | Read distance  | 0.5 to 4.5 (axial deviation ±2)  |   |
|  |   | Write distance | 0.5 to 4.0 (axial deviation ±2)  |   |
| <b>V680-D1KP53M</b><br>   | <b>V680-HS51</b><br> | Read distance  | 0.5 to 6.5 (axial deviation ±2)  |  |
|  |   | Write distance | 0.5 to 6.0 (axial deviation ±2)  |   |
|  | <b>V680-HS52</b><br> | Read distance  | 0.5 to 9.0 (axial deviation ±2)  |  |
|  |   | Write distance | 0.5 to 8.5 (axial deviation ±2)  |   |
| <b>V680-D1KP53M</b><br>(embedded in metallic surface : steel)<br> | <b>V680-HS51</b><br> | Read distance  | 0.5 to 3.5 (axial deviation ±2)  |  |
|  |   | Write distance | 0.5 to 3.0 (axial deviation ±2)  |   |
|  | <b>V680-HS52</b><br> | Read distance  | 0.5 to 4.5 (axial deviation ±2)  |  |
|  |   | Write distance | 0.5 to 4.0 (axial deviation ±2)  |   |

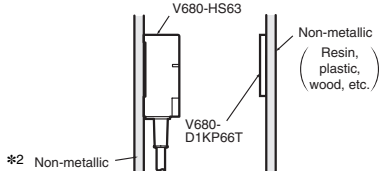

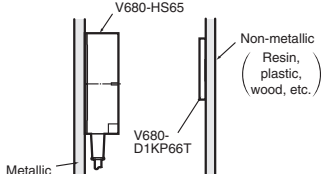
| Recommended combination  |   | Function       | Transmission distance (unit: mm)     | RF Tag and Antenna mounting conditions  |
|--|---|----------------|--------------------------------------|---|
| RF Tag   | Antenna   |                |                                      |   |
| <b>V680-D1KP66T</b><br><br> | <b>V680-HS52</b><br> | Read distance  | 1.0 to 17.0 *1 (axial deviation ±2)  |   |
|  |   | Write distance | 1.0 to 17.0 *1 (axial deviation ±2)  |   |
|  | <b>V680-HS63</b><br> | Read distance  | 5.0 to 30.0 *1 (axial deviation ±10) |   |
|  |   | Write distance | 5.0 to 25.0 *1 (axial deviation ±10) |   |
|  | <b>V680-HS65</b><br> | Read distance  | 5.0 to 47.0 *1 (axial deviation ±10) |  |
|  |   | Write distance | 5.0 to 42.0 *1 (axial deviation ±10) |   |









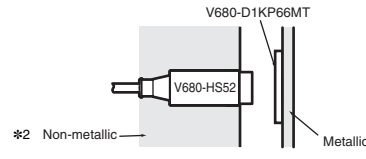

**Note:** When mounting the V680-HS65, be sure to attach the Mounting Brackets at the base of the Antenna.

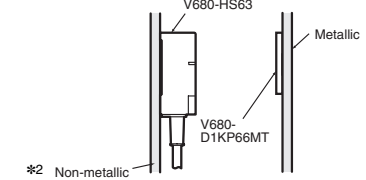
The enclosed Mounting Brackets do not need to be used, however, if the mounting brackets on the Antenna are metal plates and their dimensions are larger than the dimensions of the Antenna (100 × 100 mm).

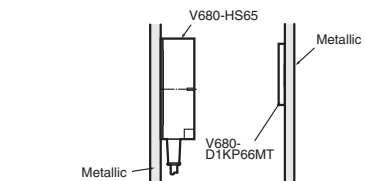
For details, refer to the User's Manual (Cat. No. Z278 or Z279).

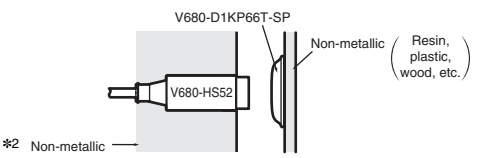
\*1. The transmission distance may be reduced if the V680-D1KP66T is mounted onto a metallic surface. Refer to the User's Manual (Cat. No. Z278 or Z279) for details.

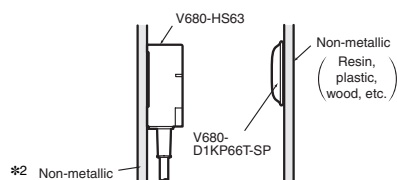
\*2. The Antenna can be mounted in metal, but the communications distance will decrease compared to mounting in nonmetal.

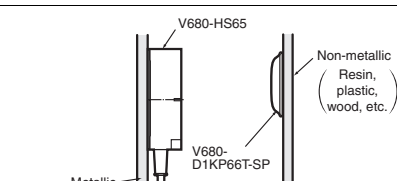
| Recommended combination  |  | Function  | Transmission distance (unit: mm)    | RF Tag and Antenna mounting conditions  |  |
|--|--|---|-------------------------------------|---|--|
| RF Tag   | Antenna  |   |                                     |   |  |
| <b>V680-D1KP66MT</b><br>(flush-mounted on metallic surface: steel) | <b>V680-HS52</b><br>  | Read distance   | 1.0 to 16.0 (axial deviation ±2)    |   |  |
|  |  | Write distance  | 1.0 to 14.0 (axial deviation ±2)    |   |  |
|  |                       | <b>V680-HS63</b><br>   | Read distance                       | 5.0 to 25.0 (axial deviation ±2)  |    |
|  |  |   | Write distance                      | 5.0 to 20.0 (axial deviation ±2)  |  |
|  |                       | <b>V680-HS65</b><br>   | Read distance                       | 5.0 to 25.0 (axial deviation ±10)   |    |
|  |  |   | Write distance                      | 5.0 to 20.0 (axial deviation ±10)   |  |
| <b>V680-D1KP66T-SP</b>   | <b>V680-HS52</b><br> | Read distance   | 1.0 to 15.0 *1 (axial deviation ±2) |  |  |
|  |  | Write distance  | 1.0 to 15.0 *1 (axial deviation ±2) |   |  |
|  |                     | <b>V680-HS63</b><br> | Read distance                       | 5.0 to 25.0 *1 (axial deviation ±10)  |  |
|  |  |   | Write distance                      | 5.0 to 20.0 *1 (axial deviation ±10)  |  |
|  |                     | <b>V680-HS65</b><br> | Read distance                       | 5.0 to 42.0 *1 (axial deviation ±10)  |  |
|  |  |   | Write distance                      | 5.0 to 37.0 *1 (axial deviation ±10)  |  |

**Note:** When mounting the V680-HS65, be sure to attach the Mounting Brackets at the base of the Antenna.













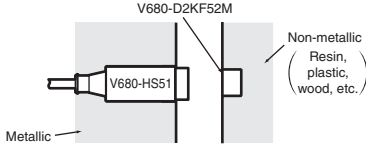

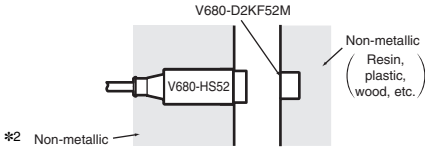

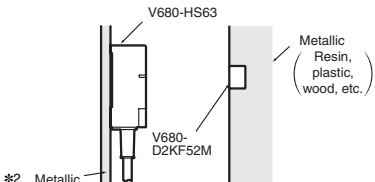
The enclosed Mounting Brackets do not need to be used, however, if the mounting brackets on the Antenna are metal plates and their dimensions are larger than the dimensions of the Antenna (100 × 100 mm).

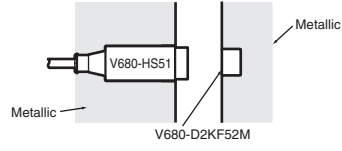
For details, refer to the User's Manual (Cat. No. Z278 or Z279).

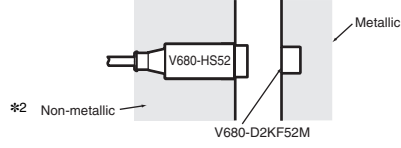
\*1. The transmission distance may be reduced if the V680-D1KP66T-SP is mounted onto a metallic surface. Refer to the User's Manual (Cat. No. Z278 or Z279) for details.

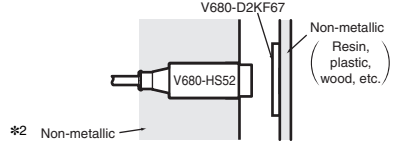
\*2. The Antenna can be mounted in metal, but the communications distance will decrease compared to mounting in nonmetal. Confirm performance using the actual devices before actual operation.

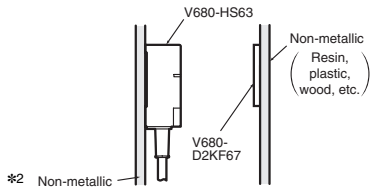
## RF Tag (2-kbyte Memory) Transmission

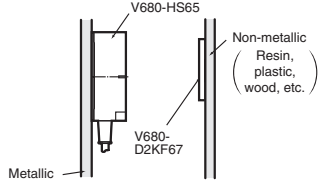
| Recommended combination   |   | Function       | Transmission distance (unit: mm)           | RF Tag and Antenna mounting conditions  |
|---|---|----------------|--|---|
| RF Tag  | Antenna   |                |  |   |
| <b>V680-D2KF52M</b><br><br>  | <b>V680-HS51</b><br><br>   | Read distance  | 0.5 to 5.5 (axial deviation $\pm 2$ )      |    |
|   |   | Write distance | 0.5 to 5.5 (axial deviation $\pm 2$ )      |   |
|   | <b>V680-HS52</b><br><br>   | Read distance  | 0.5 to 8.0 (axial deviation $\pm 2$ )      |     |
|   |   | Write distance | 0.5 to 8.0 (axial deviation $\pm 2$ )      |   |
|   | <b>V680-HS63</b><br><br>   | Read distance  | 0.5 to 9.5 (axial deviation $\pm 2$ )      |    |
|   |   | Write distance | 0.5 to 9.5 (axial deviation $\pm 2$ )      |   |
| <b>V680-D2KF52M</b><br>(embedded in metallic surface: steel)<br><br> | <b>V680-HS51</b><br><br>  | Read distance  | 0.5 to 3.5 (axial deviation $\pm 2$ )      |   |
|   |   | Write distance | 0.5 to 3.5 (axial deviation $\pm 2$ )      |   |
|   | <b>V680-HS52</b><br><br> | Read distance  | 0.5 to 3.0 (axial deviation $\pm 2$ )      |   |
|   |   | Write distance | 0.5 to 3.0 (axial deviation $\pm 2$ )      |   |
| <b>V680-D2KF67</b><br><br>   | <b>V680-HS52</b><br><br> | Read distance  | 1.0 to 17.0 *1 (axial deviation $\pm 2$ )  |   |
|   |   | Write distance | 1.0 to 17.0 *1 (axial deviation $\pm 2$ )  |   |
|   | <b>V680-HS63</b><br><br> | Read distance  | 7.0 to 30.0 *1 (axial deviation $\pm 10$ ) |   |
|   |   | Write distance | 7.0 to 30.0 *1 (axial deviation $\pm 10$ ) |   |
|   | <b>V680-HS65</b><br><br> | Read distance  | 5.0 to 42.0 *1 (axial deviation $\pm 10$ ) |  |
|   |   | Write distance | 5.0 to 42.0 *1 (axial deviation $\pm 10$ ) |   |

**Note:** When mounting the V680-HS65, be sure to attach the Mounting Brackets at the base of the Antenna.





The enclosed Mounting Brackets do not need to be used, however, if the mounting brackets on the Antenna are metal plates and their dimensions are larger than the dimensions of the Antenna (100 × 100 mm).

For details, refer to the User's Manual (Cat. No. Z278 or Z279).

\*1. The transmission distance may be reduced if the V680-D2KF67 is mounted onto a metallic surface. Refer to the User's Manual (Cat. No. Z278 or Z279) for details.

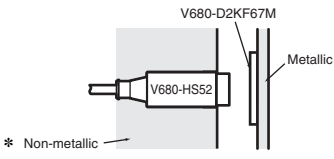

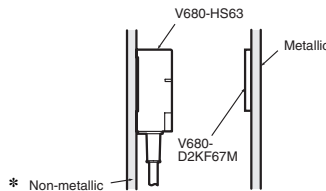

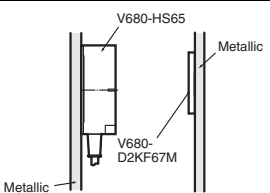
\*2. The Antenna can be mounted in metal, but the communications distance will decrease compared to mounting in nonmetal.





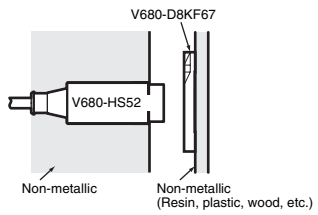

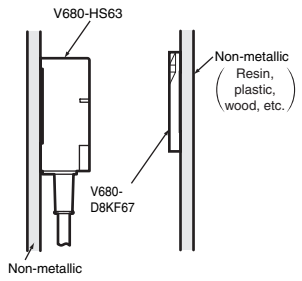

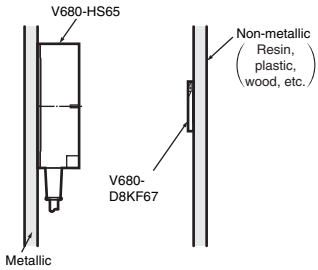

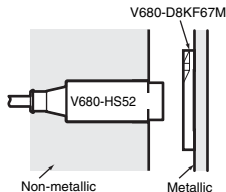

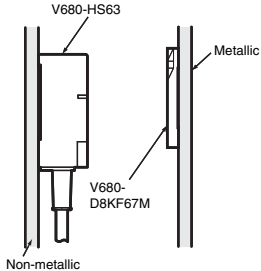
Confirm performance using the actual devices before actual operation.

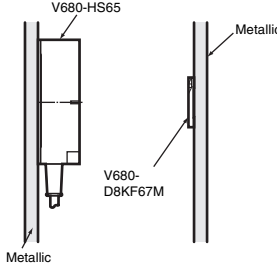
| Recommended combination   |   | Function       | Transmission distance (unit: mm)  | RF Tag and Antenna mounting conditions  |
|---|---|----------------|-----------------------------------|---|
| RF Tag  | Antenna   |                |                                   |   |
| <b>V680-D2KF67M</b><br>(flush-mounted on metallic surface: steel) | <b>V680-HS52</b><br> | Read distance  | 1.0 to 16.0 (axial deviation ±2)  |  |
|   |   | Write distance | 1.0 to 16.0 (axial deviation ±2)  |   |
|   | <b>V680-HS63</b><br> | Read distance  | 6.0 to 25.0 (axial deviation ±10) |  |
|   |   | Write distance | 6.0 to 25.0 (axial deviation ±10) |   |
|   | <b>V680-HS65</b><br> | Read distance  | 5.0 to 25.0 (axial deviation ±10) |  |
|   |   | Write distance | 5.0 to 25.0 (axial deviation ±10) |   |

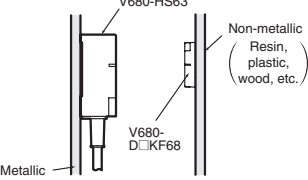
\* The Antenna can be mounted in metal, but the communications distance will decrease compared to mounting in nonmetal. Confirm performance using the actual devices before actual operation.

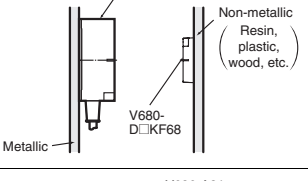
### RF Tag (8-/32-kbyte Memory) Transmission

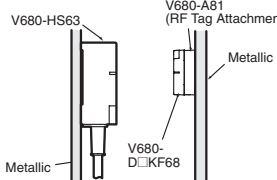
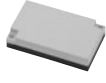

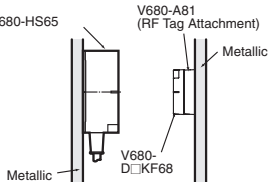





| Recommended combination |   | Function       | Transmission distance (unit: mm) | RF Tag and Antenna mounting conditions  |
|-------------------------|---|----------------|----------------------------------|---|
| RF Tag                  | Antenna   |                |                                  |   |
| <b>V680-D8KF67</b>      | <b>V680-HS52</b><br> | Read distance  | 0 to 17.0 (axial deviation ±2)   |  |
|                         |   | Write distance | 0 to 17.0 (axial deviation ±2)   |   |
|                         | <b>V680-HS63</b><br> | Read distance  | 0 to 30.0 (axial deviation ±10)  |  |
|                         |   | Write distance | 0 to 30.0 (axial deviation ±10)  |   |
|                         | <b>V680-HS65</b><br> | Read distance  | 0 to 42.0 (axial deviation ±10)  |  |
|                         |   | Write distance | 0 to 42.0 (axial deviation ±10)  |   |

| Recommended combination  |   | Function  | Transmission distance (unit: mm)          | RF Tag and Antenna mounting conditions  |   |
|--|---|---|---|---|---|
| RF Tag   | Antenna   |   |   |   |   |
| <b>V680-D8KF67M</b><br>(flush-mounted on metallic surface: steel)  | <b>V680-HS52</b><br>   | Read distance   | 0 to 16.0 (axial deviation $\pm 2$ )      |    |   |
|  |   | Write distance  | 0 to 16.0 (axial deviation $\pm 2$ )      |   |   |
|  |                        | <b>V680-HS63</b><br>   | Read distance                             | 0 to 25.0 (axial deviation $\pm 10$ )   |    |
| Write distance   |   |   | 0 to 25.0 (axial deviation $\pm 10$ )     |   |   |
|                                   | <b>V680-HS65</b><br>   | Read distance   | 0 to 25.0 (axial deviation $\pm 10$ )     |   |   |
|  |   | Write distance  | 0 to 25.0 (axial deviation $\pm 10$ )     |   |   |
| <b>V680-D8KF68/-D32KF68</b><br> | <b>V680-HS63</b><br> | Read distance   | 5.0 to 45.0 * (axial deviation $\pm 10$ ) |  |   |
|  |   | Write distance  | 5.0 to 45.0 * (axial deviation $\pm 10$ ) |   |   |
|  |                      | <b>V680-HS65</b><br> | Read distance                             | 5.0 to 75.0 * (axial deviation $\pm 10$ )   |  |
|  |   |   | Write distance                            | 5.0 to 75.0 * (axial deviation $\pm 10$ )   |   |
| <b>V680-D8KF68/-D32KF68</b><br>(Special attachment provided; flush-mounted on metallic surface: steel)             | <b>V680-HS63</b><br> | Read distance   | 5.0 to 35.0 (axial deviation $\pm 10$ )   |  |   |
|  |   | Write distance  | 5.0 to 35.0 (axial deviation $\pm 10$ )   |   |   |
|  |                      | <b>V680-HS65</b><br> | Read distance                             | 5.0 to 55.0 (axial deviation $\pm 10$ )   |  |
|  |   |   | Write distance                            | 5.0 to 55.0 (axial deviation $\pm 10$ )   |   |

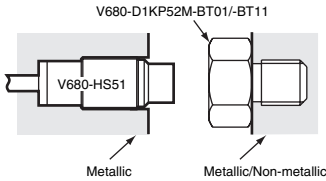
**Note:** When mounting the V680-HS65, be sure to attach the Mounting Brackets at the base of the Antenna. The enclosed Mounting Brackets do not need to be used, however, if the mounting brackets on the Antenna are metal plates and their dimensions are larger than the dimensions of the Antenna (100 × 100 mm). For details, refer to the User's Manual (Cat. No. Z278 or Z279).

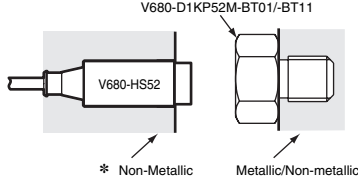
\* The transmission distance may be reduced if the V680-D□KF68 is mounted onto a metallic surface. Use V680-A81 special attachment. Refer to the User's Manual (Cat. No. Z278 or Z279) for details.

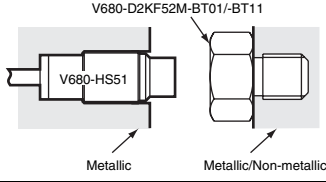
## Bolt RF Tag (1-kbyte or 2-kbyte Memory) Transmission

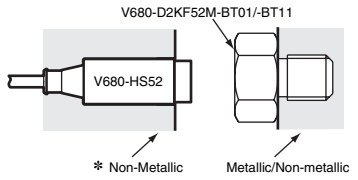
| Recommended combination   |  | Function       | Transmission distance (unit: mm) | RF Tag and Antenna mounting conditions   |
|---|--|----------------|----------------------------------|--|
| RF Tag  | Antenna  |                |                                  |  |
| <b>V680-D1KP52M-BT01/-BT11</b><br><br> | <b>V680-HS51</b><br><br>  | Read distance  | 0.5 to 2.5 (axial deviation ±2)  | <b>V680-D1KP52M-BT01/-BT11</b><br>  |
|   |  | Write distance | 0.5 to 2.0 (axial deviation ±2)  |  |
| <b>V680-D2KF52M-BT01/-BT11</b><br><br> | <b>V680-HS52</b><br><br>  | Read distance  | 0.5 to 3.0 (axial deviation ±2)  | <b>V680-D1KP52M-BT01/-BT11</b><br>  |
|   |  | Write distance | 0.5 to 2.5 (axial deviation ±2)  |  |
| <b>V680-D2KF52M-BT01/-BT11</b><br><br> | <b>V680-HS51</b><br><br>  | Read distance  | 0.5 to 2.5 (axial deviation ±2)  | <b>V680-D2KF52M-BT01/-BT11</b><br>  |
|   |  | Write distance | 0.5 to 2.5 (axial deviation ±2)  |  |
|   | <b>V680-HS52</b><br><br> | Read distance  | 0.5 to 2.0 (axial deviation ±2)  | <b>V680-D2KF52M-BT01/-BT11</b><br> |
|   |  | Write distance | 0.5 to 2.0 (axial deviation ±2)  |  |

\* Mounting can be performed in metal, but the communications distance will decrease compared to mounting in nonmetal. Confirm performance using the actual devices before actual operation.

## Characteristic Data (Typical)

### Transmission Range (Typical)

#### ID Controller (using the V680-CA5D0□-V2, CJ1W-V680C11/C12, or CS1W-V680-C11/C12)

(unit: mm)

#### 1-kbyte Memory RF Tag

The values given for communications ranges are reference values. Refer to pages 17 to 19, 23 for communications distance specifications. The communications distance will depend on the RF Tags, ambient temperature, surrounding metal, noise, and other factors. Test operation completely when installing a system.

#### V680-HS52 (embedded in non-metallic material) & V680-D1KP52MT (embedded in non-metallic material)

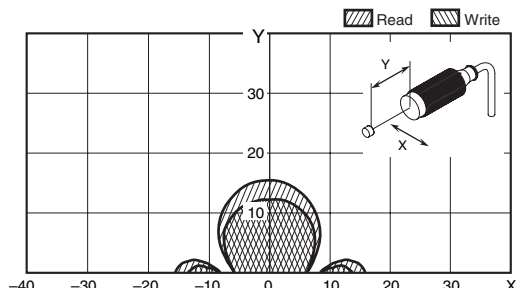

#### V680-HS51 (embedded in metallic material) & V680-D1KP52MT (embedded in non-metallic material)

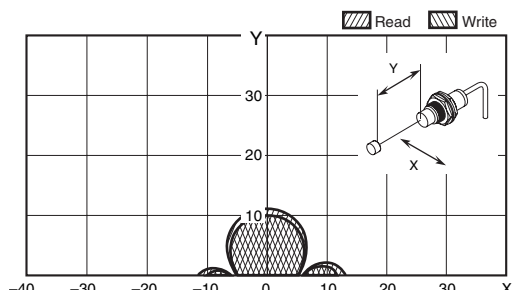

#### V680-HS63 (mounted on non-metallic material) & V680-D1KP52MT (embedded in non-metallic material)

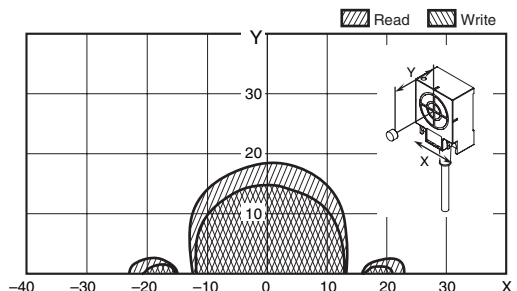

#### V680-HS51 (embedded in metallic material) & V680-D1KP53M (embedded in non-metallic material)

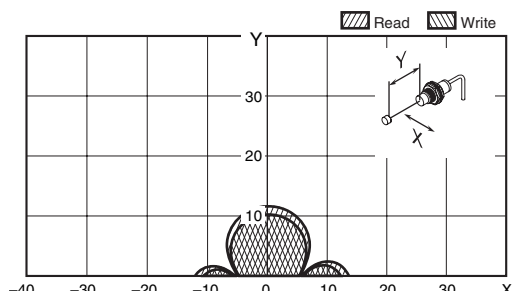

#### V680-HS52 (embedded in non-metallic material) & V680-D1KP53M (embedded in non-metallic material)

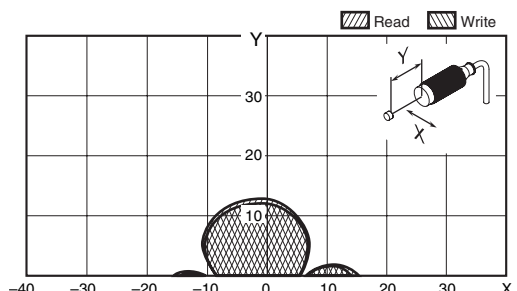

#### V680-HS52 (embedded in non-metallic material) & V680-D1KP52MT (embedded in metallic surface: steel)

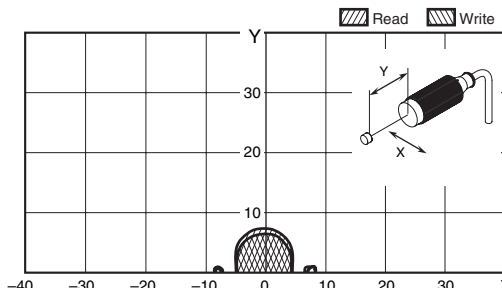

#### V680-HS51 (embedded in metallic material) & V680-D1KP52MT (embedded in metallic surface: steel)

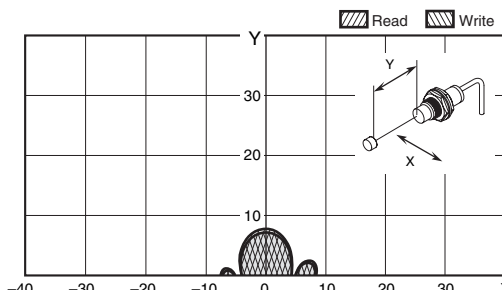

#### V680-HS51 (embedded in metallic material) & V680-D1KP53M (embedded in metallic surface: steel)

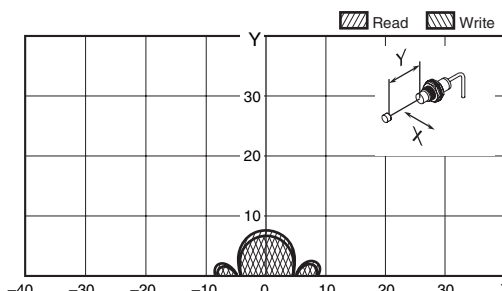

#### V680-HS52 (embedded in non-metallic material) & V680-D1KP53M (embedded in metallic surface: steel)

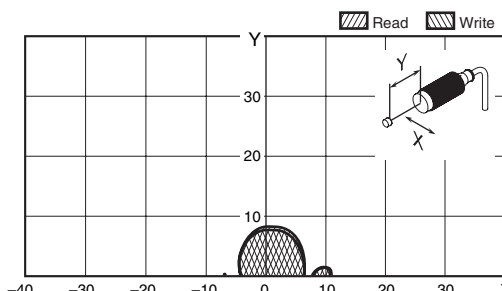

**V680-HS52 (embedded in non-metallic material) & V680-D1KP54T (mounted on non-metallic material)**

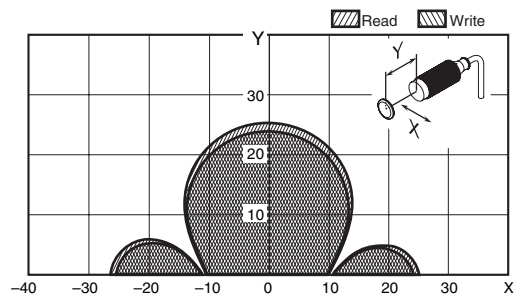

**V680-HS63 (mounted on non-metallic material) & V680-D1KP54T (mounted on non-metallic material)**

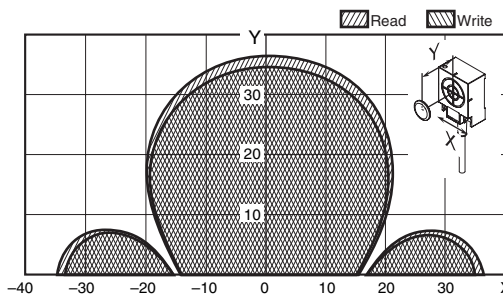

**V680-HS65 (mounted on metallic material) & V680-D1KP54T (mounted on non-metallic material)**

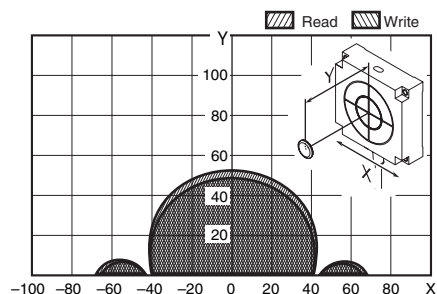

**V680-HS63 (mounted on non-metallic material) & V680-D1KP66T (mounted on non-metallic material)**

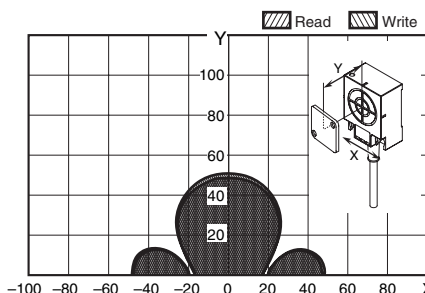

**V680-HS52 (embedded in non-metallic material) & V680-D1KP66T (mounted on non-metallic material)**

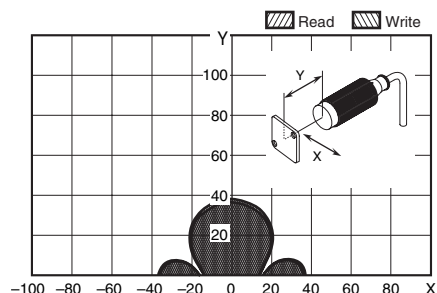

**V680-HS65 (mounted on metallic material) & V680-D1KP66T (mounted on non-metallic material)**

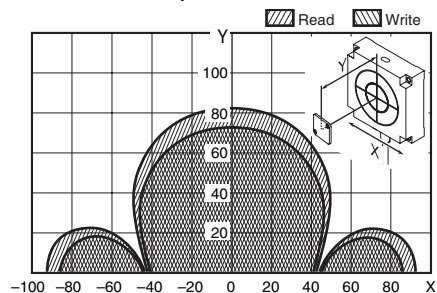

**V680-H01-V2 (mounted on non-metallic material) & V680-D1KP66T (mounted on non-metallic material)**

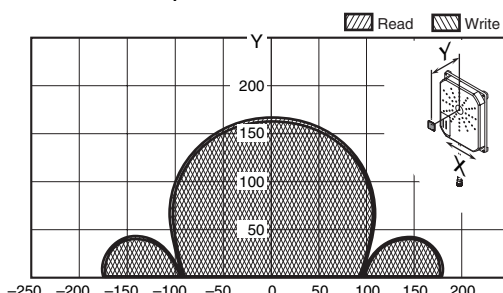

**V680-HS52 (embedded in non-metallic material) & V680-D1KP66T-SP (mounted on non-metallic material)**

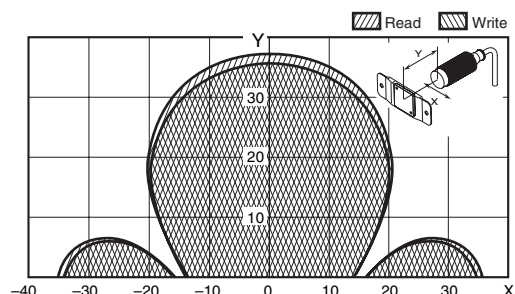

**V680-HS63 (mounted on non-metallic material) & V680-D1KP66T-SP (mounted on non-metallic material)**

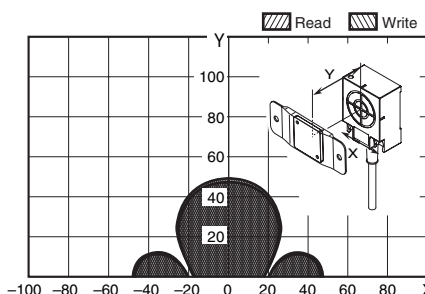



**V680-HS65 (mounted on metallic material) & V680-D1KP66T-SP (mounted on non-metallic material)**

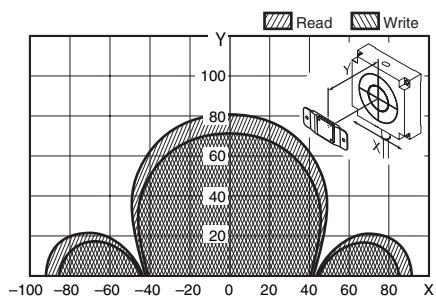

**V680-HS52 (embedded in non-metallic material) & V680-D1KP66MT (mounted on metallic surface: steel)**

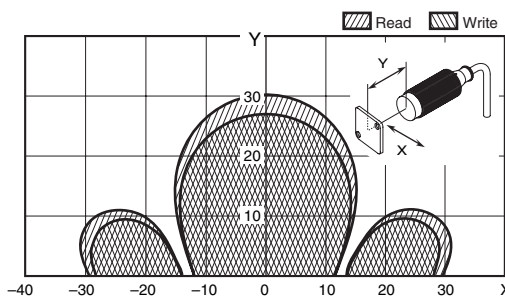

**V680-HS63 (mounted on non-metallic material) & V680-D1KP66MT (mounted on metallic surface: steel)**

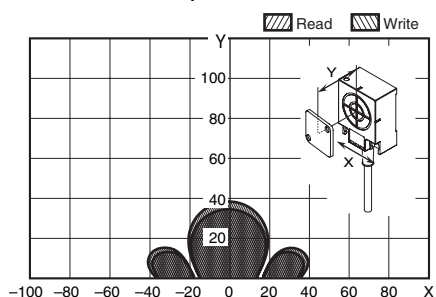

**V680-HS65 (mounted on metallic material) & V680-D1K66MT (mounted on metallic surface: steel)**

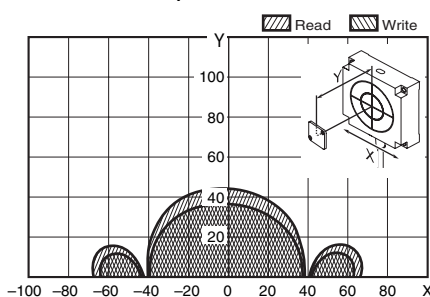

**1-kbyte Memory Bolt RF Tags**

**V680-HS51 (embedded in metallic material) & V680-D1KP52M-BT01 (mounted in metal/non-metallic material)**

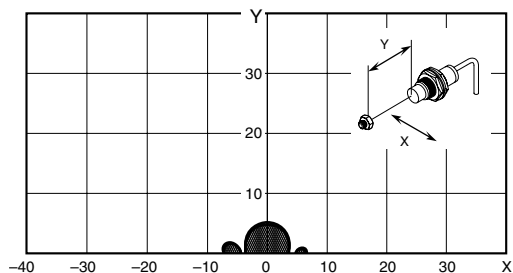

**V680-HS51 (embedded in metallic material) & V680-D1KP52M-BT11 (mounted in metal/non-metallic material)**

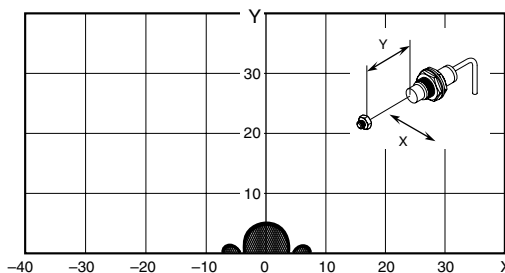

**V680-HS52 (embedded in non-metallic material) & V680-D1KP52M-BT01 (mounted in metal/non-metallic material)**

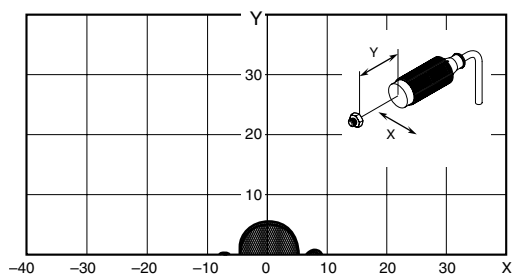

**High-temperature Type 1-kbyte Memory RF Tags**

**V680-H01 (mounted on non-metallic material) & V680-D1KP58HT (mounted on non-metallic material)**

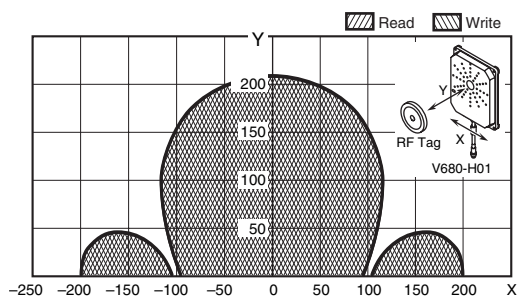

**2-kbyte Memory RF Tag**

The values given for communications ranges are reference values. Refer to pages 20 to 21, 23 for communications distance specifications. The communications distance will depend on the RF Tags, ambient temperature, surrounding metal, noise, and other factors. Test operation completely when installing a system.

**V680-HS52 (embedded in non-metallic material) & V680-D2KF52M (embedded in non-metallic material)**

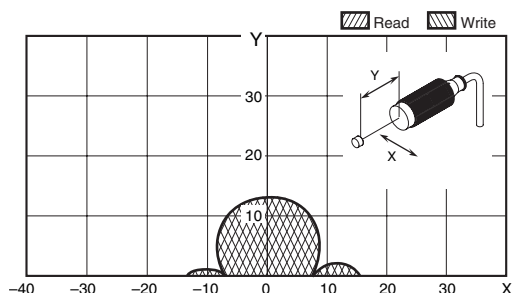

**V680-HS52 (embedded in non-metallic material) & V680-D2KF52M (embedded in metallic surface: steel)**

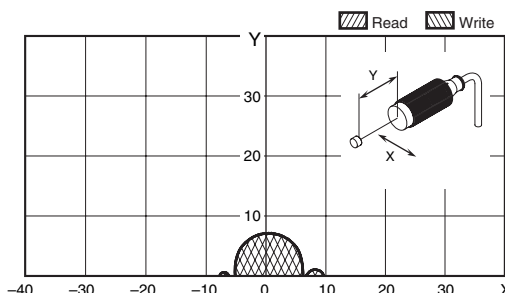

**V680-HS51 (embedded in metallic material) & V680-D2KF52M (embedded in non-metallic material)**

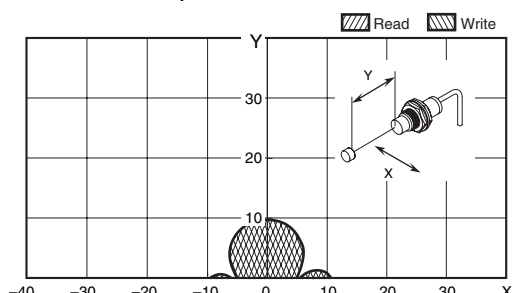

**V680-HS51 (embedded in metallic material) & V680-D2KF52M (embedded in metallic surface: steel)**

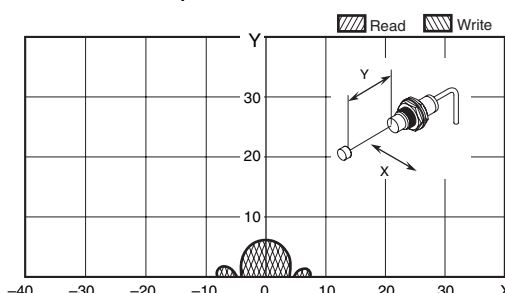

**V680-HS63 (mounted on non-metallic material) & V680-D2KF52M (embedded in non-metallic material)**

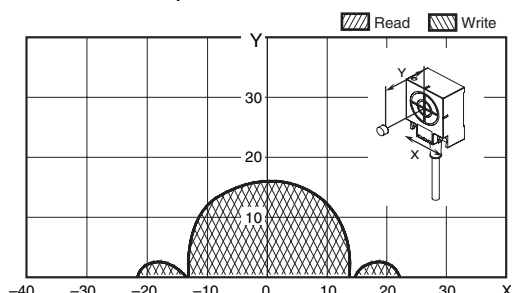

**V680-HS52 (embedded in metallic material) & V680-D2KF67 (mounted on non-metallic material)**

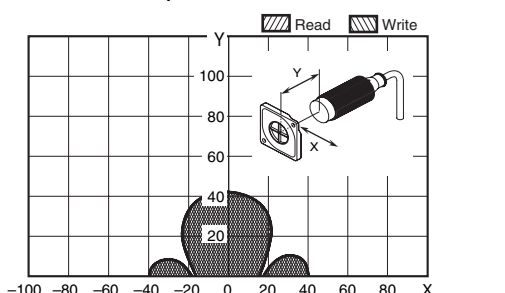

**V680-HS63 (mounted on non-metallic material) & V680-D2KF67 (mounted on non-metallic material)**

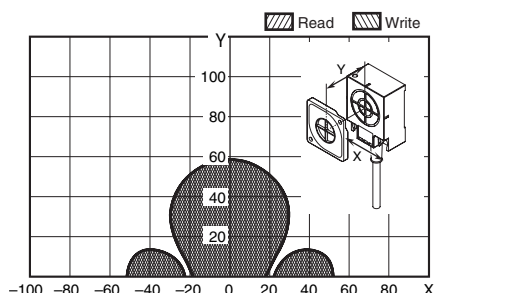

**V680-HS65 (mounted on metallic material) & V680-D2KF67 (mounted on non-metallic material)**

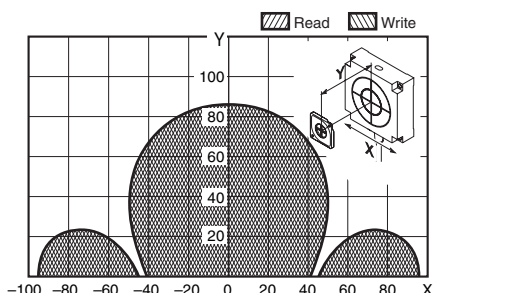

**V680-H01-V2 (mounted on non-metallic material) & V680-D2KF67 (mounted on non-metallic material)**

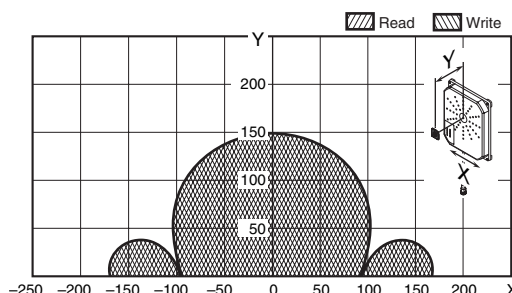

**V680-HS52 (embedded in non-metallic material) & V680-D2KF67M (mounted on metallic surface: steel)**

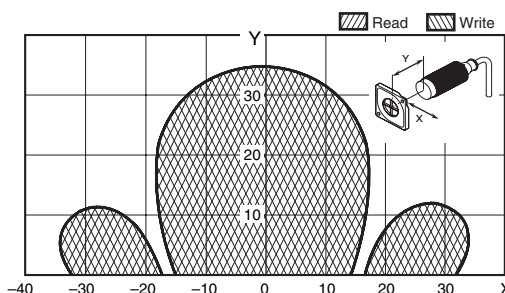

**V680-HS63 (mounted on non-metallic material) & V680-D2KF67M (mounted on metallic surface: steel)**

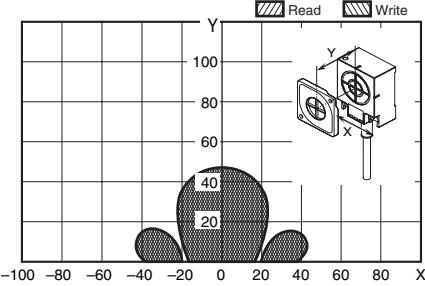

**V680-HS65 (mounted on metallic material) & V680-D2KF67M (mounted on metallic surface: steel)**

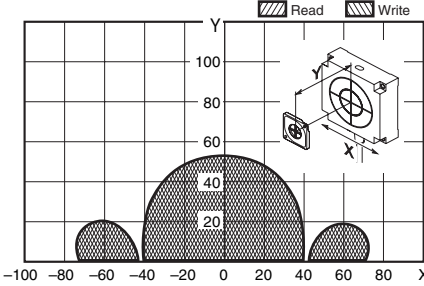

**2-kbyte Memory Bolt RF Tags**

**V680-HS51 (embedded in metallic material) & V680-D2KF52M-BT01 (mounted in metal/non-metallic material)**

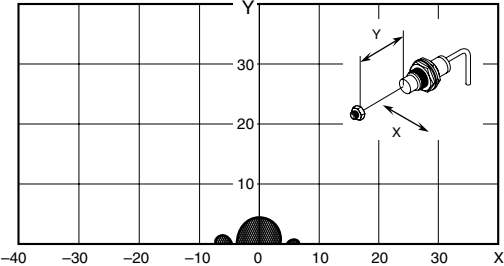

**V680-HS51 (embedded in metallic material) & V680-D2KF52M-BT11 (mounted in metal/non-metallic material)**

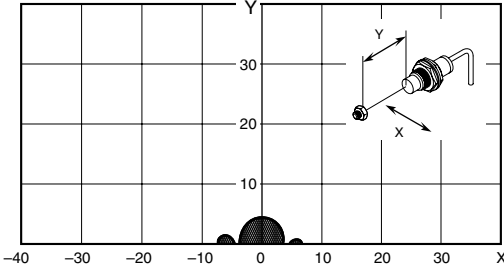

**V680-HS52 (embedded in non-metallic material) & V680-D2KF52M-BT01 (mounted in metal/non-metallic material)**

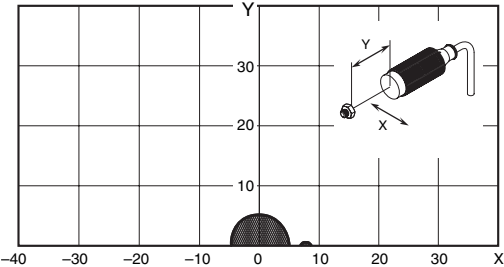

**8-/32-kbyte Memory RF Tag**

The values given for communications ranges are reference values. Refer to pages 21 to 22 for communications distance specifications. The communications distance will depend on the RF Tags, ambient temperature, surrounding metal, noise, and other factors. Test operation completely when installing a system.

**V680-HS52 (embedded in non-metallic material) & V680-D8KF67 (mounted on non-metallic material)**

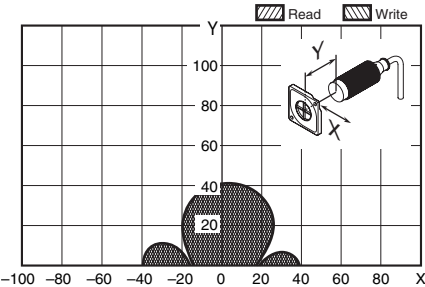

**V680-HS63 (mounted on non-metallic material) & V680-D8KF67 (mounted on non-metallic material)**

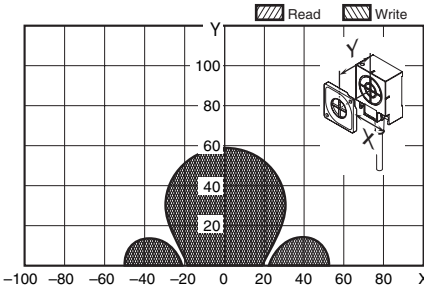

**V680-HS65 (mounted on metallic material) & V680-D8KF67 (mounted on non-metallic material)**

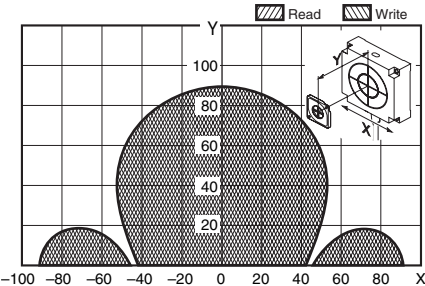

**V680-H01-V2 (mounted on non-metallic material) & V680-D8KF67 (mounted on non-metallic material)**

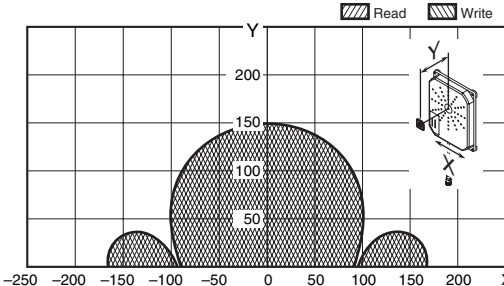

**V680-HS52 (embedded in non-metallic material) & V680-D8KF67M (mounted on metallic surface: steel)**

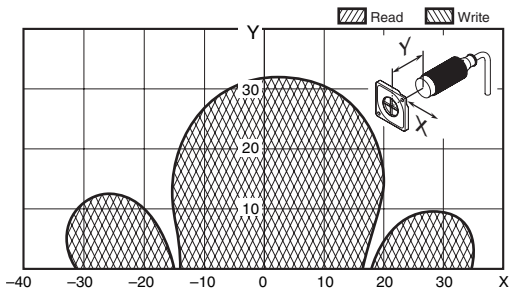

**V680-HS63 (mounted on non-metallic material) & V680-D8KF67M (mounted on metallic surface: steel)**

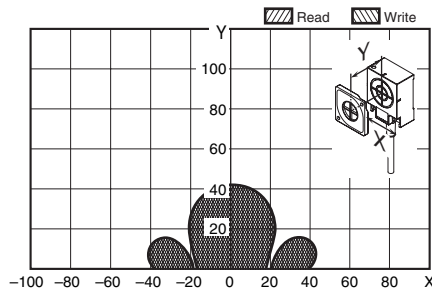

**V680-HS65 (mounted on metallic material) & V680-D8KF67M (mounted on metallic surface: steel)**

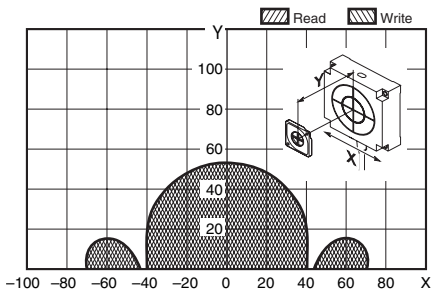

**V680-HS63 (mounted on metallic material) & V680-D8KF68/-D32KF68 (mounted on non-metallic material) (Horizontal-facing RF Tag)**      **V680-HS63 (mounted on metallic material) & V680-D8KF68/-D32KF68 (mounted on non-metallic material) (Vertical-facing RF Tag)**

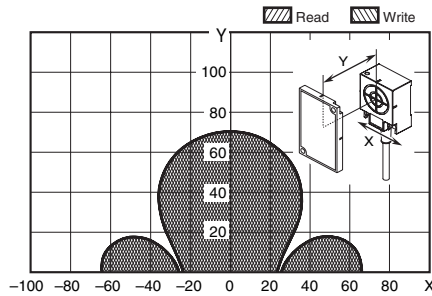
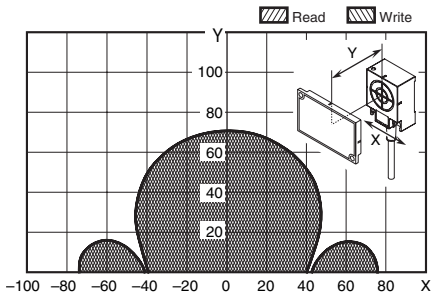

**V680-HS63 (mounted on metallic material) & V680-D8KF68/-D32KF68 (mounted on metallic surface: steel) (Horizontal-facing RF Tag)**      **V680-HS63 (mounted on metallic material) & V680-D8KF68/-D32KF68 (mounted on metallic surface: steel) (Vertical-facing RF Tag)**

When the V680-A81 attachment is mounted on RF Tag

When the V680-A81 attachment is mounted on RF Tag

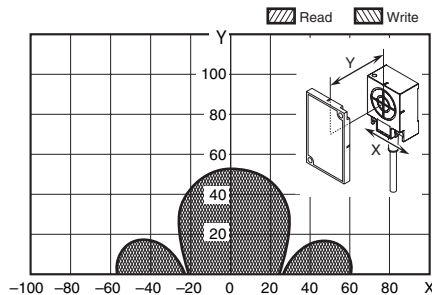
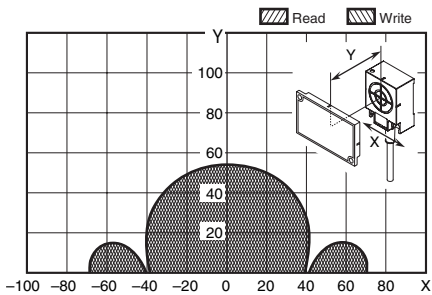

**V680-HS65 (mounted on metallic material) & V680-D8KF68/-D32KF68 (Horizontal-facing RF Tag)**

**V680-HS65 (mounted on metallic material) & V680-D8KF68/-D32KF68 (Vertical-facing RF Tag)**

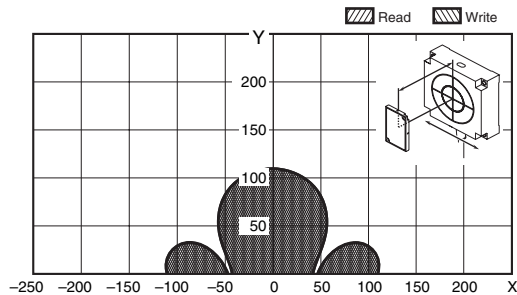
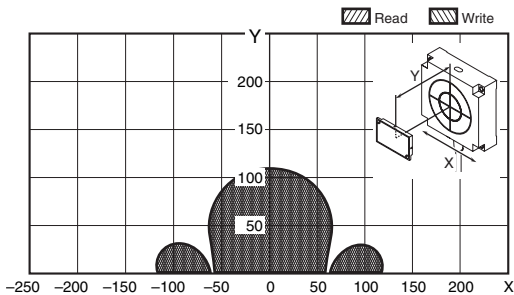

**V680-HS65 (mounted on metallic material) & V680-D8KF68/-D32KF68 (flush-mounted on metallic surface: steel) (Horizontal-facing RF Tag)**  
**When the V680-A81 attachment is mounted on RF Tag**

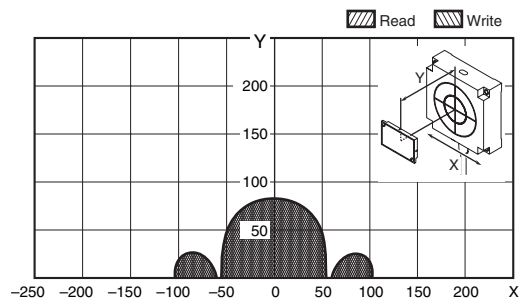

**V680-HS65 (mounted on metallic material) & V680-D8KF68/-D32KF68 (flush-mounted on metallic surface: steel) (Vertical-facing RF Tag)**  
**When the V680-A81 attachment is mounted on RF Tag**

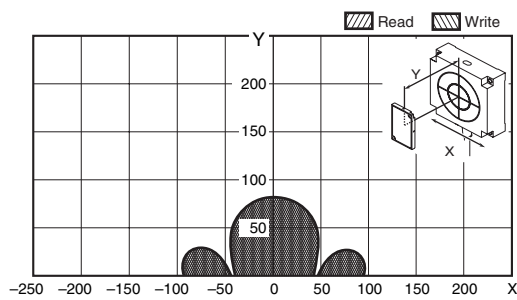

**V680-H01-V2 (mounted on non-metallic material) & V680-D8KF68/-D32KF68 (Horizontal-facing RF Tag)**

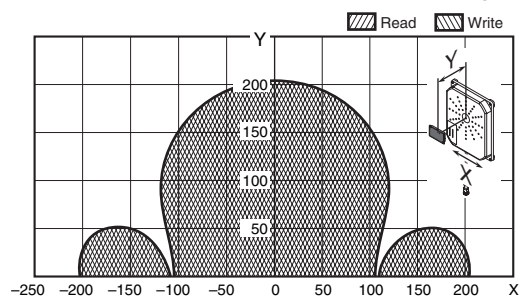

**V680-H01-V2 (mounted on non-metallic material) & V680-D8KF68/-32KF68 (Vertical-facing RF Tag)**

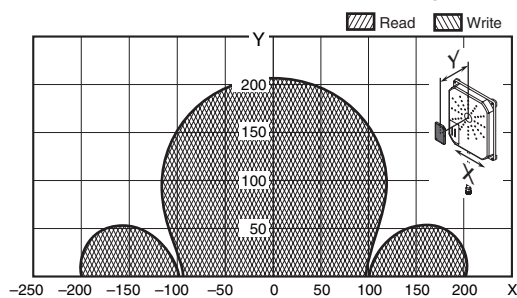

**DeviceNet ID Slave (When Using the V680-HAM42-DRT)  
PROFIBUS ID Slave (When Using the V680-HAM42-PRT)  
ID Flag Sensors (When Using the V680-HAM91/-HAM81)**

**1-kbyte Memory RF Tag**

The values given for communications ranges are reference values. Refer to pages 24 to 26, 30 for communications distance specifications. For information on the combinations that can be used, refer to Combinations of Amplifier Units, Antennas, and RF Tags on pages 2 to 3. The communications distance will depend on the RF Tags, ambient temperature, surrounding metal, noise, and other factors. Test operation completely when installing a system.

**V680-HS52 (embedded in non-metallic material) & V680-D1KP52MT (embedded in non-metallic material)**

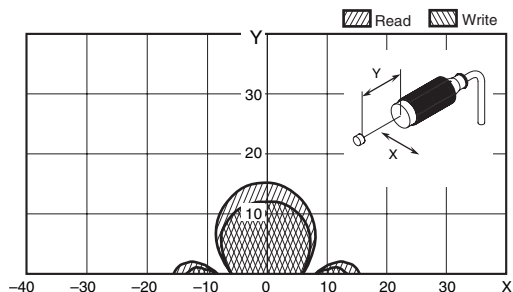

**V680-HS51 (embedded in metallic material) & V680-D1KP52MT (embedded in non-metallic material)**

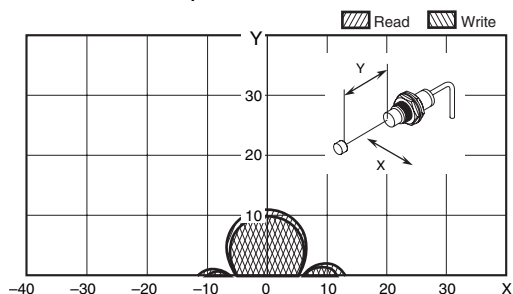

**V680-HS63 (mounted on non-metallic material) & V680-D1KP52MT (embedded in non-metallic material)**

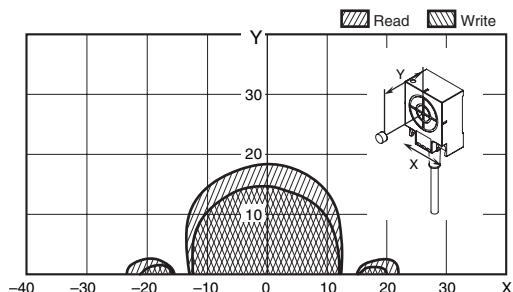

**V680-HS63 (mounted on non-metallic material) & V680-D1KP66T (mounted on non-metallic material)**

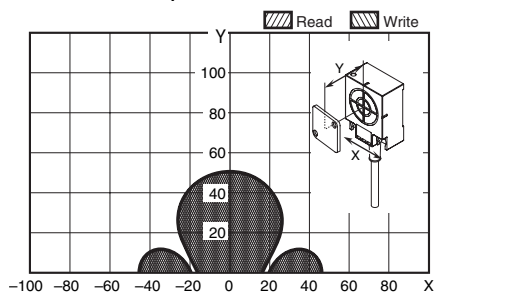

**V680-HS52 (embedded in non-metallic material) & V680-D1KP66T-SP (embedded in non-metallic material)**

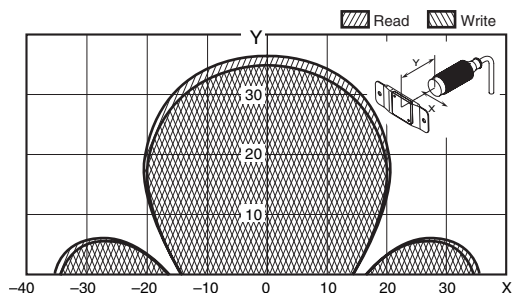

**V680-HS52 (embedded in non-metallic material) & V680-D1KP52MT (embedded in metallic surface: steel)**

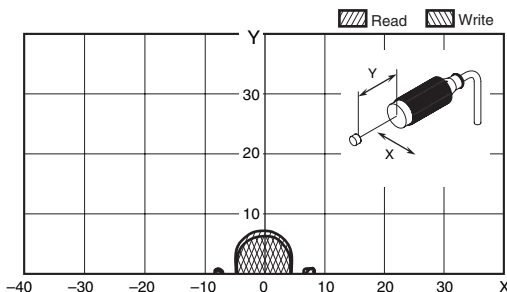

**V680-HS51 (embedded in metallic material) & V680-D1KP52MT (embedded in metallic surface: steel)**

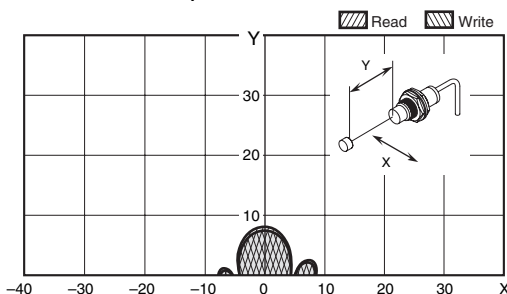

**V680-HS52 (embedded in non-metallic material) & V680-D1KP66T (mounted on non-metallic material)**

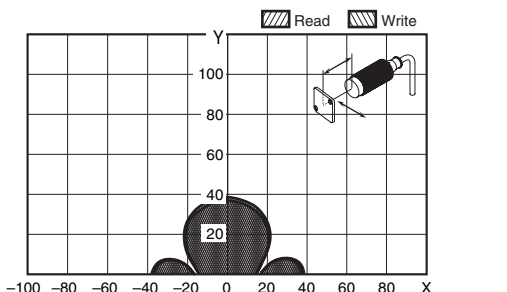

**V680-HS65 (mounted on metallic material) & V680-D1KP66T (mounted on non-metallic material)**

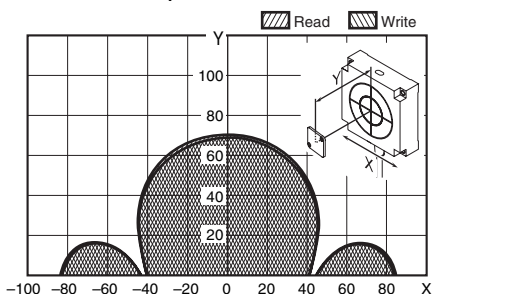

**V680-HS63 (mounted on non-metallic material) & V680-D1KP66T-SP (mounted on non-metallic material)**

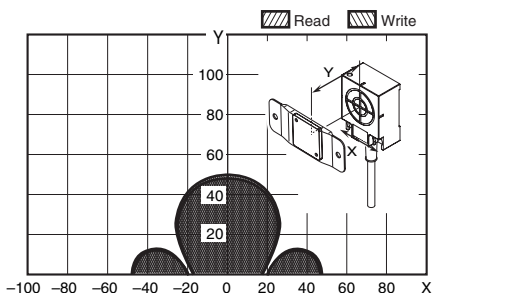

**V680-HS65 (mounted on metallic material) & V680-D1KP66T-SP (mounted on non-metallic material)**

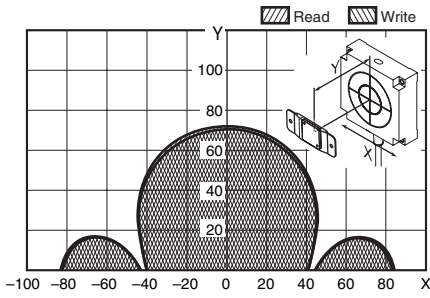

**V680-HS63 (mounted on non-metallic material) & V680-D1KP66MT (mounted on metallic surface: steel)**

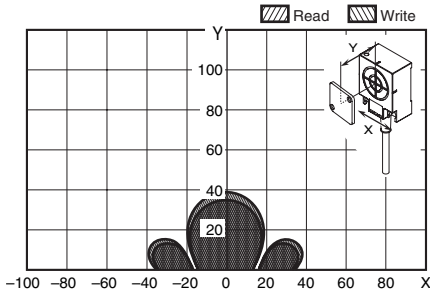

**V680-HS52 (embedded in non-metallic material) & V680-D1KP66MT (mounted on metallic surface: steel)**

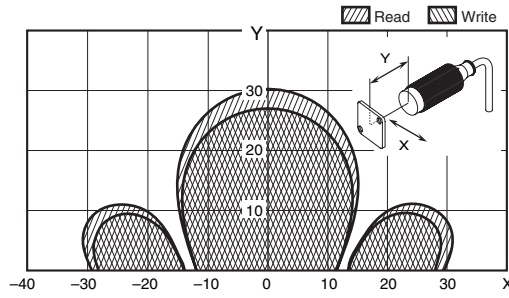

**V680-HS65 (mounted on metallic material) & V680-D1K66MT (mounted on metallic surface: steel)**

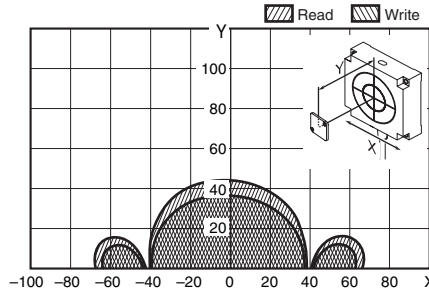

**1-kbyte Memory Bolt RF Tags**

**V680-HS51 (embedded in metallic material) & V680-D1KP52M-BT01 (mounted in metal/non-metallic material)**

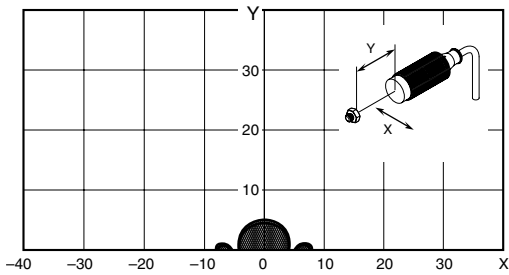

**V680-HS52 (embedded in non-metallic material) & V680-D1KP52M-BT01 (mounted in metal/non-metallic material)**

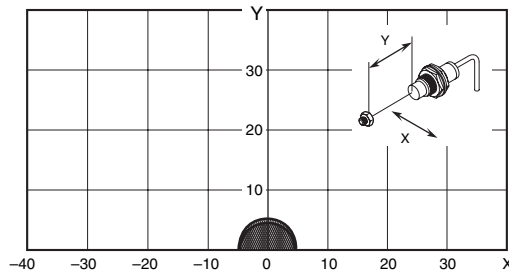

**2-kbyte Memory RF Tag**

The values given for communications ranges are reference values. Refer to pages 27 to 28, 30 for communications distance specifications. For information on the combinations that can be used, refer to Combinations of Amplifier Units, Antennas, and RF Tags on pages 2 to 3. The communications distance will depend on the RF Tags, ambient temperature, surrounding metal, noise, and other factors. Test operation completely when installing a system.

**V680-HS52 (embedded in non-metallic material) & V680-D2KF52M (embedded in non-metallic material)**

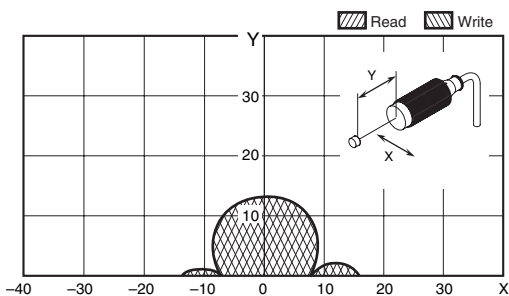

**V680-HS52 (embedded in non-metallic material) & V680-D2KF52M (embedded in metallic surface: steel)**

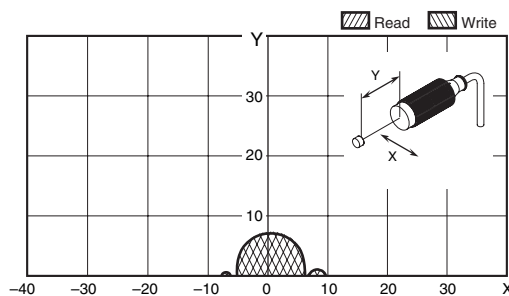

**V680-HS51 (embedded in metallic material) & V680-D2KF52M (embedded in non-metallic material)**

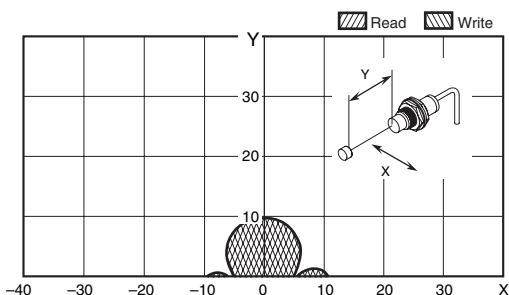

**V680-HS51 (embedded in metallic material) & V680-D2KF52M (embedded in metallic surface: steel)**

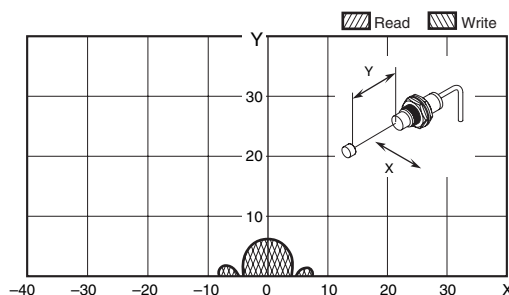

**V680-HS63 (mounted on non-metallic material) & V680-D2KF52M (embedded in non-metallic material)**

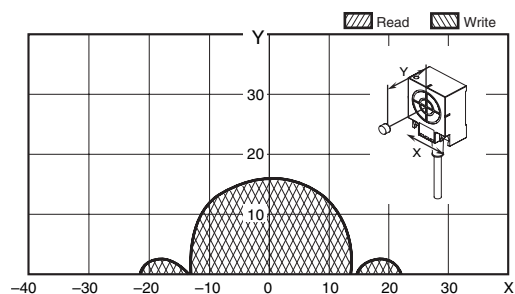

**V680-HS63 (mounted on non-metallic material) & V680-D2KF67 (mounted on non-metallic material)**

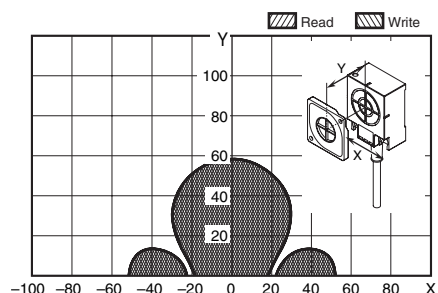

**V680-HS52 (embedded in non-metallic material) & V680-D2KF67M (mounted on metallic surface: steel)**

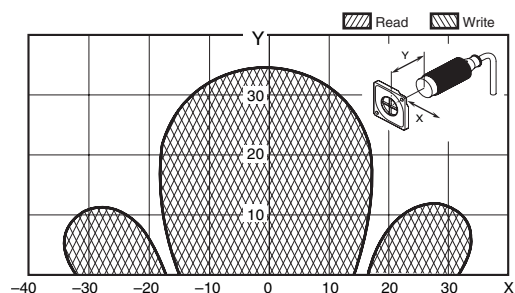

**V680-HS65 (mounted on metallic material) & V680-D2KF67M (mounted on metallic surface: steel)**

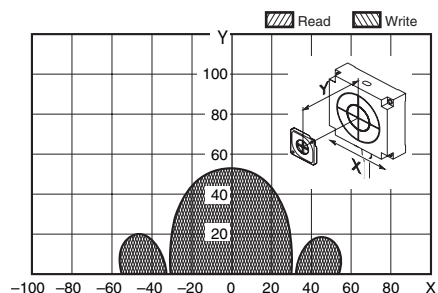

**2-kbyte Memory Bolt RF Tags**

**V680-HS51 (embedded in metallic material) & V680-D2KF52M-BT01 (mounted in metal/non-metallic material)**

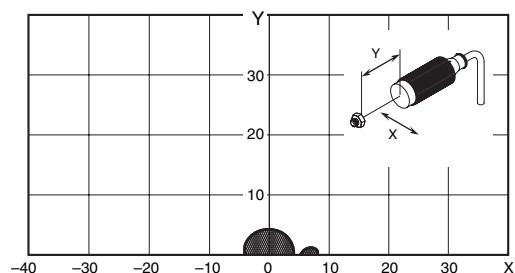

**V680-HS52 (embedded in non-metallic material) & V680-D2KF67 (mounted on non-metallic material)**

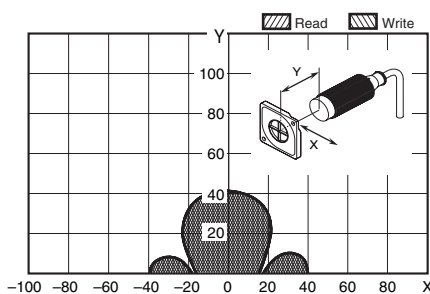

**V680-HS65 (mounted on metallic material) & V680-D2KF67 (mounted on non-metallic material)**

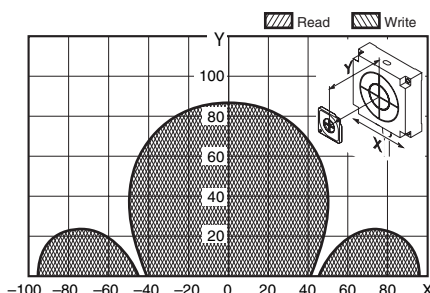

**V680-HS63 (mounted on non-metallic material) & V680-D2KF67M (mounted on metallic surface: steel)**

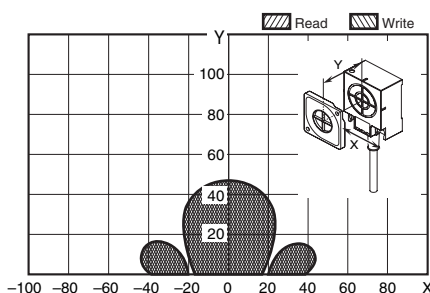

**V680-HS52 (embedded in non-metallic material) & V680-D2KF52M-BT01 (mounted in metal/non-metallic material)**

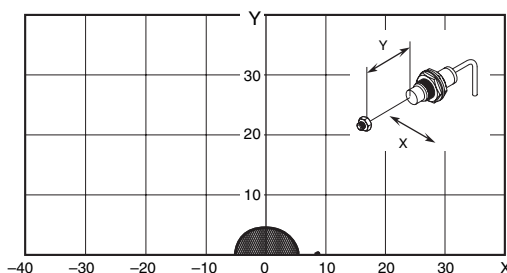



**8-/32-kbyte Memory RF Tag**

The values given for communications ranges are reference values. Refer to pages 28 to 29 for communications distance specifications. For information on the combinations that can be used, refer to Combinations of Amplifier Units, Antennas, and RF Tags on pages 2 to 3. The communications distance will depend on the RF Tags, ambient temperature, surrounding metal, noise, and other factors. Test operation completely when installing a system.

**V680-HS63 (mounted on metallic material) & V680-D8KF68/-D32KF68 (mounted on non-metallic material) (Horizontal-facing RF Tag)**

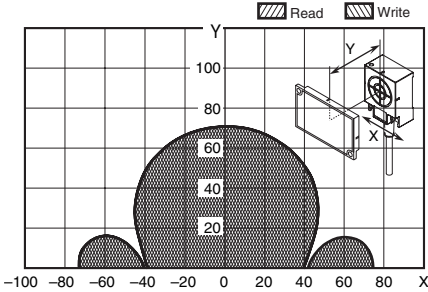

**V680-HS63 (mounted on metallic material) & V680-D8KF68/-D32KF68 (mounted on non-metallic material) (Vertical-facing RF Tag)**

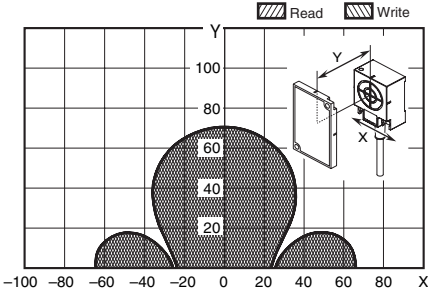

**V680-HS63 (mounted on metallic material) & V680-D8KF68/-D32KF68 (mounted on metallic surface: steel) (Horizontal-facing RF Tag)**  
When the V680-A81 attachment is mounted on RF Tag

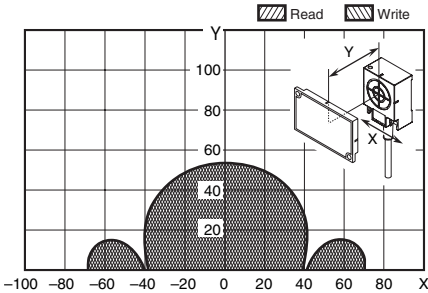

**V680-HS63 (mounted on metallic material) & V680-D8KF68/-D32KF68 (mounted on metallic surface: steel) (Vertical-facing RF Tag)**  
When the V680-A81 attachment is mounted on RF Tag

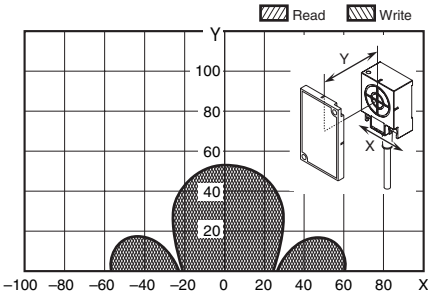

**V680-HS65 (mounted on metallic material) & V680-D8KF68/-D32KF68 (mounted on non-metallic material) (Horizontal-facing RF Tag)**

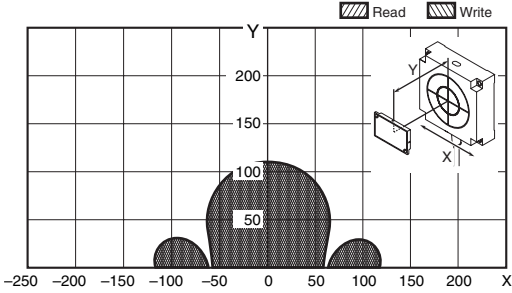

**V680-HS65 (mounted on metallic material) & V680-D8KF68/-D32KF68 (mounted on non-metallic material) (Vertical-facing RF Tag)**

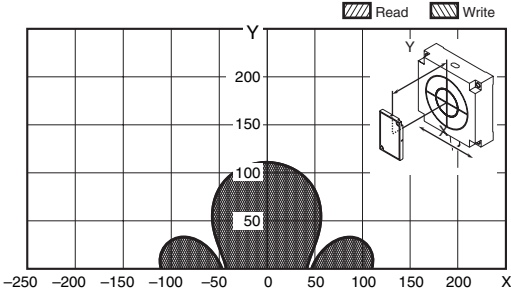

**V680-HS65 (mounted on metallic material) & V680-D8KF68/-D32KF68 (flush-mounted on metallic surface: steel) (Horizontal-facing RF Tag)**  
When the V680-A81 attachment is mounted on RF Tag

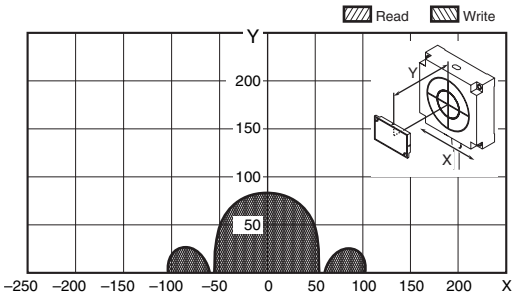

**V680-HS65 (mounted on metallic material) & V680-D8KF68/-D32KF68 (flush-mounted on metallic surface: steel) (Vertical-facing RF Tag)**  
When the V680-A81 attachment is mounted on RF Tag

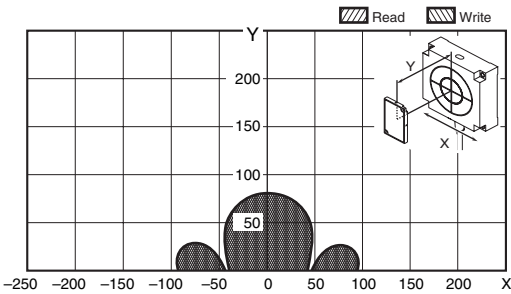

## Communications Time

### Communications Time between Antennas and Tags

#### ID Controllers (V680-CA5D0□-V2, CJ1W-V680C11/C12, CS1W-V680C11/12)

##### 1-kbyte Memory RF Tag

V680-D1KP□ (used in combination with the V680-HS□□ Antenna, V680-HA63A Amplifier Unit and V680-H01-V2 Antenna)

V680-D1KP58HT (used in combination with the V680-H01-V2 Antenna)

##### ●Transmission speed: Normal mode

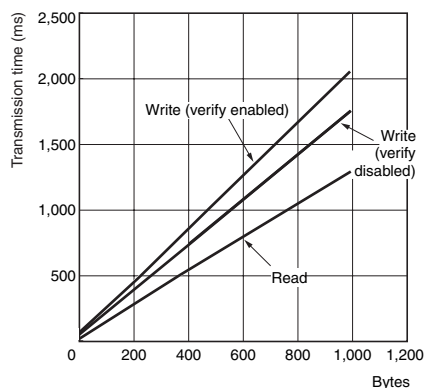

##### ●Transmission speed: High-speed mode

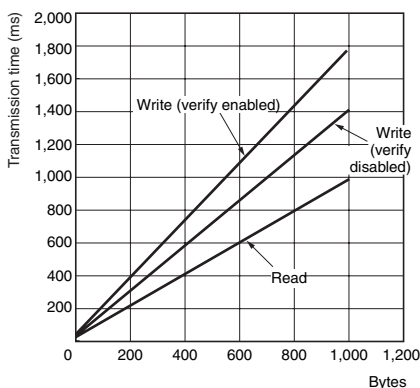

| Controller or ID Sensor Unit transmission speed setting | Command | Write verification setting | Transmission time (ms)<br>N = Number of processing bytes |
|---|---------|----------------------------|--|
| Normal mode   | Read    | —                          | $T=1.3N+31$  |
|   | Write   | Enabled                    | $T=2.1N+58$  |
| Disabled  |         | $T=1.8N+56$                |  |
| High-speed mode *1, *2                                  | Read    | —                          | $T=1.0N+29$  |
|   | Write   | Enabled                    | $T=1.8N+51$  |
| Disabled  |         | $T=1.5N+47$                |  |

\*1. The V680-H01 Antenna cannot be used in high-speed mode.

\*2. When multi-access or FIFO is selected as the transmission option, the transmission time will be the same as in normal mode even when the transmission speed is set to high-speed mode.

##### 2-kbyte Memory RF Tag

V680-D2KF□□ (used in combination with the V680-HS□□ Antenna, V680-HA63B Amplifier Unit and V680-H01-V2 Antenna)

##### ●Transmission speed: Normal mode

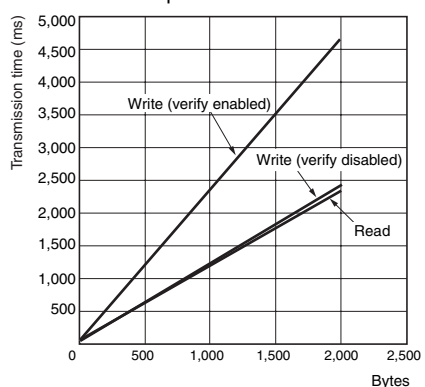

##### ●Transmission speed: High-speed mode

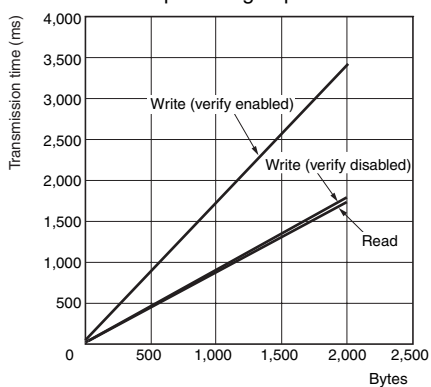

| Controller or ID Sensor Unit transmission speed setting | Command | Write verification setting | Transmission time (ms)<br>N = Number of processing bytes |
|---|---------|----------------------------|--|
| Normal mode   | Read    | —                          | $T=1.2N+30$  |
|   | Write   | Enabled                    | $T=2.4N+49$  |
| Disabled  |         | $T=1.2N+49$                |  |
| High-speed mode *                                       | Read    | —                          | $T=0.9N+27$  |
|   | Write   | Enabled                    | $T=1.7N+49$  |
| Disabled  |         | $T=0.9N+41$                |  |

\*When multi-access or FIFO is selected as the transmission option, the transmission time will be the same as in normal mode even when the transmission speed is set to high-speed mode.

##### 8-/32-kbyte Memory RF Tag

V680-D8KF□□, V680-D32KF□□

(used in combination with the V680-HS□□ Antenna, V680-HA63B Amplifier Unit and V680-H01-V2 Antenna)

##### ●Transmission speed: Normal mode

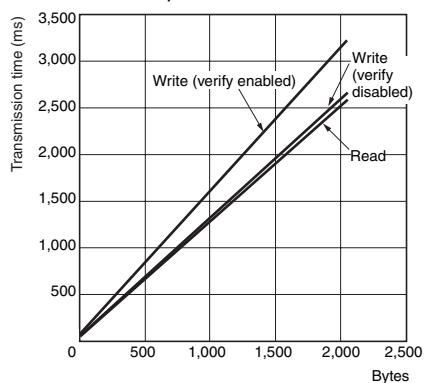

##### ●Transmission speed: High-speed mode

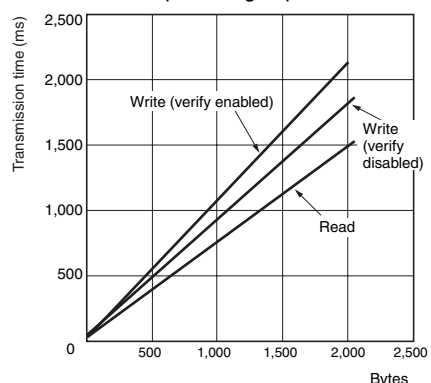

| Controller or ID Sensor Unit transmission speed setting | Command | Write verification setting | Transmission time (ms)<br>N = Number of processing bytes |
|---|---------|----------------------------|--|
| Normal mode   | Read    | —                          | $T=1.3N+30$  |
|   | Write   | Enabled                    | $T=1.6N+59$  |
| Disabled  |         | $T=1.3N+50$                |  |
| High-speed mode *                                       | Read    | —                          | $T=0.8N+25$  |
|   | Write   | Enabled                    | $T=1.1N+41$  |
| Disabled  |         | $T=0.9N+40$                |  |

\*When multi-access or FIFO is selected as the transmission option, the transmission time will be the same as in normal mode even when the transmission speed is set to high-speed mode.

**Communications Time (Communications Time between Antenna and RF Tag + Processing Time at Amplifier Unit)**

**DeviceNet ID Slave (V680-HAM42-DRT)  
PROFIBUS ID Slave (V680-HAM42-PRT)**

**1-kbyte Memory RF Tags**

V680-D1KP□ (V680-HS□□ Antenna)

| Communications time setting | Command                 | Communications time (ms)   |                     |                     |                        |
|-----------------------------|-------------------------|--|---------------------|---------------------|------------------------|
|                             |                         | 4-byte Access Mode   | 26-byte Access Mode | 58-byte Access Mode | V600-compatible mode * |
| Normal                      | Read                    | 67   | 95                  | 137                 | 67                     |
|                             | Write with Verification | 105  | 143                 | 210                 | 105                    |
|                             | Data Fill               | V680-HAM42-DRT: 17.5 × No. of processed blocks + 89.2<br>V680-HAM42-PRT: 20.6 × No. of processed blocks + 76.8 |                     |                     | –                      |
| High speed                  | Read                    | 63   | 85                  | 117                 | –                      |
|                             | Write with Verification | 89   | 128                 | 186                 | –                      |
|                             | Data Fill               | V680-HAM42-DRT: 14.8 × No. of processed blocks + 71.7<br>V680-HAM42-PRT: 18.8 × No. of processed blocks + 66.4 |                     |                     | –                      |

**2-kbyte Memory RF Tags**

V680-D2KF□ (V680-HS□□ Antenna)

| Communications time setting | Command                 | Communications time (ms)   |                     |                     |                        |
|-----------------------------|-------------------------|--|---------------------|---------------------|------------------------|
|                             |                         | 4-byte Access Mode   | 26-byte Access Mode | 58-byte Access Mode | V600-compatible mode * |
| Normal                      | Read                    | 65   | 92                  | 130                 | 65                     |
|                             | Write with Verification | 105  | 142                 | 219                 | 105                    |
|                             | Data Fill               | V680-HAM42-DRT: 17.5 × No. of processed blocks + 89.2<br>V680-HAM42-PRT: 21.2 × No. of processed blocks + 86.4 |                     |                     | –                      |
| High speed                  | Read                    | 61   | 81                  | 110                 | –                      |
|                             | Write with Verification | 86   | 124                 | 178                 | –                      |
|                             | Data Fill               | V680-HAM42-DRT: 14.8 × No. of processed blocks + 71.7<br>V680-HAM42-PRT: 17.2 × No. of processed blocks + 74.6 |                     |                     | –                      |

**8-kbyte/32-kbyte Memory RF Tags**

V680-D8KF□□ and V680-D32KF68 (V680-HS□□ Antenna)

| Communications time setting | Command                 | Communications time (ms)   |                     |                     |                        |
|-----------------------------|-------------------------|--|---------------------|---------------------|------------------------|
|                             |                         | 4-byte Access Mode   | 26-byte Access Mode | 58-byte Access Mode | V600-compatible mode * |
| Normal                      | Read                    | 66   | 94                  | 136                 | 66                     |
|                             | Write with Verification | 96   | 131                 | 182                 | 96                     |
|                             | Data Fill               | V680-HAM42-DRT: 17.5 × No. of processed blocks + 89.2<br>V680-HAM42-PRT: 13.8 × No. of processed blocks + 87.4 |                     |                     | –                      |
| High speed                  | Read                    | 59   | 76                  | 102                 | –                      |
|                             | Write with Verification | 76   | 100                 | 135                 | –                      |
|                             | Data Fill               | V680-HAM42-DRT: 14.8 × No. of processed blocks + 71.7<br>V680-HAM42-PRT: 9.0 × No. of processed blocks + 77.0  |                     |                     | –                      |

\* The V680-HAM42-PRT does not support V600-compatible mode.

**ID Flag Sensors (V680-HAM91/-HAM81)**

| RF Tag                          | Operating Mode | Communications time (ms)     |                           |
|---------------------------------|----------------|------------------------------|---------------------------|
|                                 |                | Read                         | Write                     |
|                                 |                | Data Read, Verification read | Write, Bit Set, Bit Clear |
| 1-kbyte/2-kbyte Memory RF Tag   |                | 43                           | 87                        |
| 8-kbyte/32-kbyte Memory RF Tags |                | 50                           | 84                        |

$$\text{RF Tag travel speed (conveyor speed)} = \frac{\text{Travel distance (D) in communications area}}{\text{Communications time (T)}}$$

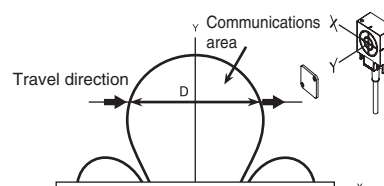

**Calculation Example**

**Read Processing Using Combination of V680-D1KP66T and V680-HS63**

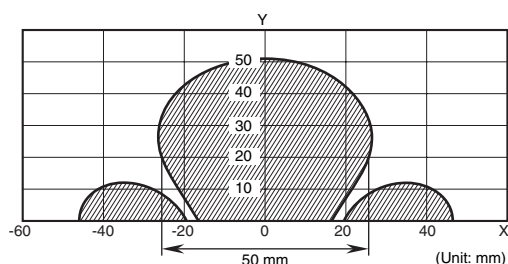

$$\text{RF Tag travel speed (m/min)} = \frac{50(\text{mm})}{43(\text{ms})} \div 60 \approx 69(\text{m/min})$$

- Note:**
1. The travel speed depends on factors such as the communications distance Y and axial deviation. Therefore, it is recommended to refer to the communications area figure and to perform operation using the widest part of the area.
  2. The calculated value is a rough guide.  
Perform testing with the actual devices before actual operation.
  3. This calculation formula does not include communications error processing.

### TAT When Using an ID Controller (Reference Values)

#### TAT (Turn Around Time)

TAT refers to the total time required from the point at which a host device (such as a personal computer) starts sending a command until a response is received.

$$\text{TAT} = \text{Command send time} + \text{RF Tag transmission time} + \text{response}$$

Command send time: This is the time required for sending a command from the host device to the Controller.

It varies depending on the communications speed and format.

RF Tag transmission time: This is the time required for transmission between the Antenna and the RF Tag.

Response receipt time: This is the time required for returning a response from the Controller to the host device.

It varies depending on the communications speed and format.

- For an ordinary command

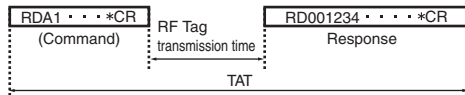

- Expansion Read Command

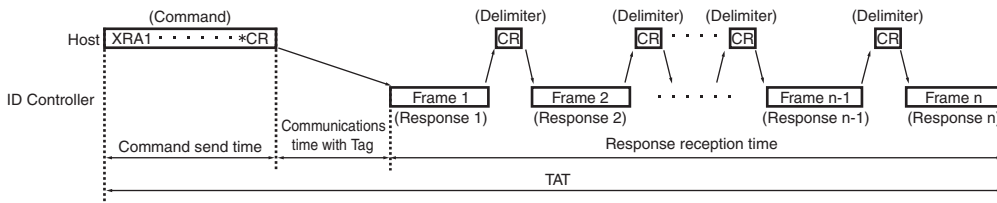

- Expansion Write Command

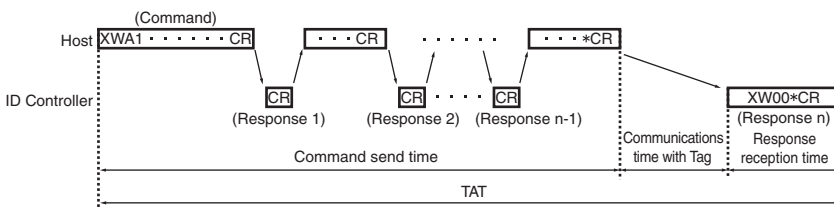

## Safety Precautions

### WARNING

Do not use this product as a detection device to protect people.



\* This catalog is intended only to help select the appropriate product. Be sure to read the User's Manual for usage precautions prior to using the product.

### Precautions for Safe Use

To ensure safety, be sure to follow the following precautions:

1. Do not operate this product in any flammable, explosive, or corrosive gas environment.
2. Do not disassemble, repair, or remodel this product.
3. Tighten the base lock screws and terminal block screws completely.
4. Be sure to use wiring crimp terminals of the specified size.
5. If any cable has a locking mechanism, be sure to check that it has been locked before using it.
6. The DC power supply must be within the specified rating (24 VDC +10%/–15%).
7. Do not reverse the power supply connection.
8. Do not insert water, wire, etc., into any of the gaps in the case. Doing so may cause fire or electric shock.
9. Turn OFF the Controller or ID Sensor Unit power before attaching or removing the Antenna.
10. If multiple Antennas are mounted near each other, communications performance may decrease due to mutual interference. Refer to the manual for the Antennas and RF Tags and check to make sure there is no mutual interference before installation.
11. To remove the ID Controller, catch a tool on the mounting hook and gently remove the Unit.
12. Wire correctly and do not short-circuit the load. The ID Controller may rupture or burn.
13. Do not use in environments that are subject to oil.
14. Never use an AC power supply.
15. In the event that the product exhibits any abnormal condition, immediately stop using the system, turn OFF the power, and contact your OMRON sales representative.
16. Dispose of this product as industrial waste.
17. Be sure to follow any other warnings, cautions, and notices given in this document.

### Precautions for Correct Use

Please observe the following precautions to prevent failure to operate, malfunctions, or undesirable effects on product performance.

#### Installation Site

Install the product at a location where:

- It is not exposed to corrosive gases, dust, metal chips, or salt.
- The ambient operating temperature is within the range stipulated in the specifications.
- There are no sudden variations in temperature (no condensation).
- The ambient operating humidity is within the range stipulated in the specifications.
- No vibration or shock exceeding the values stipulated in the specifications is transmitted directly to the body of the product.
- It is not subject to splashing water, oil, or chemical substances.

#### Installation

- The product uses the 13.56-MHz frequency band to communicate with RF Tags. Some devices, such as some motors, inverters, and switching power supplies, generate electromagnetic waves (i.e., noise) that can affect communications with RF Tags. If any of these devices are nearby, communications with RF Tags may be affected or RF Tags may be destroyed. If the product is to be used near such devices, check the effects on communications before using the product.
- To minimize the general influence of noise, observe the following precautions:
  1. Ground any metallic material located around this device to 100Ω or less.
  2. Keep the product away from high voltage and heavy current.
- Do not pull on the cable.
- Do not use products that are not waterproof in misty environments.
- Do not subject the products to chemicals that adversely affect product materials.
- When installing the product, tighten screws to the following torque:

|   |                |
|---|----------------|
| Controller:                             | 1.2 N·m max    |
| ID Sensor Unit:                         | 0.4 N·m        |
| V680-HS51 Antenna:                      | 6 N·m          |
| V680-HS52 Antenna:                      | 40 N·m         |
| V680-HS63 Antenna:                      | 1.2 N·m        |
| V680-HS65 Antenna:                      | 1.2 N·m        |
| V680-H01-V2 Antenna:                    | 1.2 N·m        |
| (Attach the enclosed Mounting Brackets) |                |
| V680-D1KP66T/-D1KP66MT:                 | 0.5 N·m        |
| V680-D1KP66T-SP:                        | 1.2 N·m        |
| V680-D1KP54T:                           | 0.3 to 0.5 N·m |
| V680-D2KF67/-D2KF67M:                   | 0.6 N·m        |
| V680-D8KF67/-D8KF67M:                   | 0.6 N·m        |
| V680-D8KF68/-D32KF68:                   | 1.2 N·m        |

#### Communications with Host (V680-HAM91/-HAM81)

The I/O status may be unstable when the ID Controller is started.

After turning ON the power supply to the ID Controller, allow at least 1 second to elapse before performing control.

#### Storage

Store the product at a location where:

- It is not exposed to corrosive gases, dust, metal chips, or salt.
- The ambient storage temperature is within the range stipulated in the specifications.
- There are no sudden variations in temperature (no condensation).
- The ambient storage humidity is within the range stipulated in the specifications.
- No vibration or shock exceeding the values stipulated in the specifications is transmitted directly to the body of the product.
- It is not subject to splashing water, oil, or chemical substances.

#### Cleaning

Do not use thinner, benzene, acetone, or kerosene for cleaning.

Using these substances may dissolve the resin material and the case.

## Dimensions

### RF Tag

#### V680-D1KP52MT/-D2KF52M

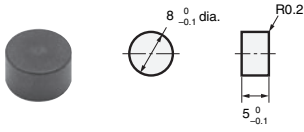

|                      |             |
|----------------------|-------------|
| <b>Case material</b> | PPS resin   |
| <b>Filling</b>       | Epoxy resin |

#### V680-D1KP53M

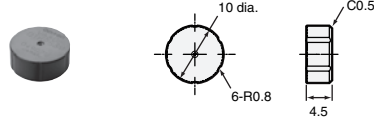

|                      |             |
|----------------------|-------------|
| <b>Case material</b> | PPS resin   |
| <b>Filling</b>       | Epoxy resin |

#### V680-D1KP54T

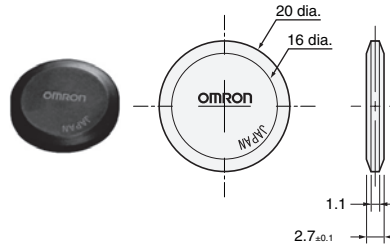

|                      |           |
|----------------------|-----------|
| <b>Case material</b> | PPS resin |
|----------------------|-----------|

#### V680-D1KP66T/-D1KP66MT

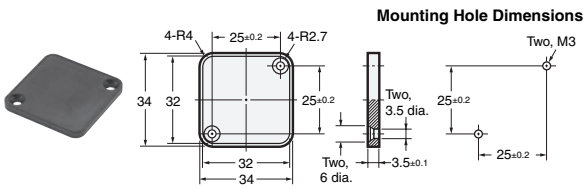

|                      |           |
|----------------------|-----------|
| <b>Case material</b> | PPS resin |
|----------------------|-----------|

#### V680-D1KP66T-SP

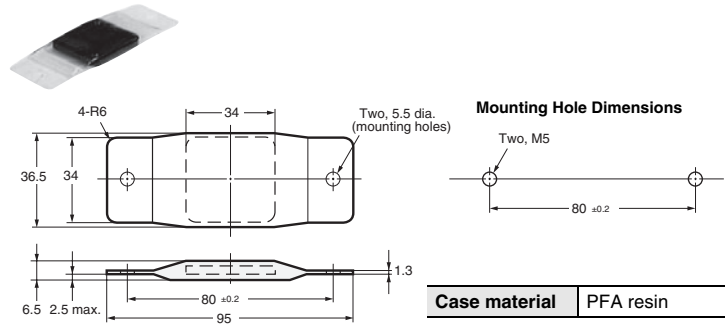

|                      |           |
|----------------------|-----------|
| <b>Case material</b> | PFA resin |
|----------------------|-----------|

#### V680-D2KF67/-D2KF67M

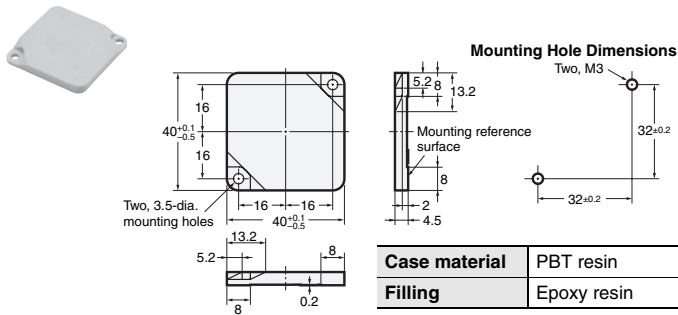

|                      |             |
|----------------------|-------------|
| <b>Case material</b> | PBT resin   |
| <b>Filling</b>       | Epoxy resin |

#### V680-D8KF67/-D8KF67M

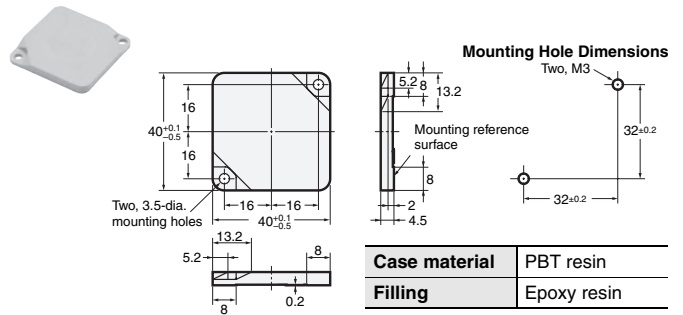

|                      |             |
|----------------------|-------------|
| <b>Case material</b> | PBT resin   |
| <b>Filling</b>       | Epoxy resin |

#### V680-D8KF68/-D32KF68

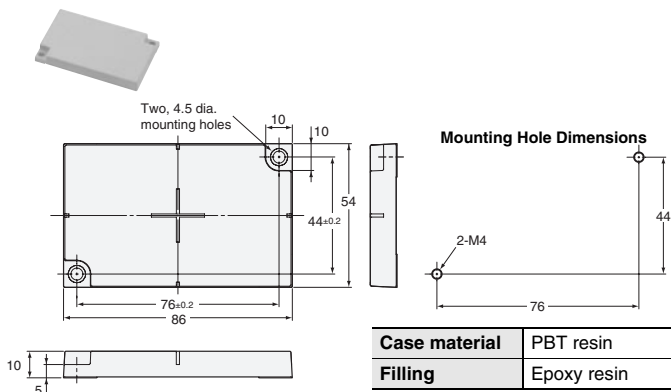

|                      |             |
|----------------------|-------------|
| <b>Case material</b> | PBT resin   |
| <b>Filling</b>       | Epoxy resin |

#### V680-D1KP58HT

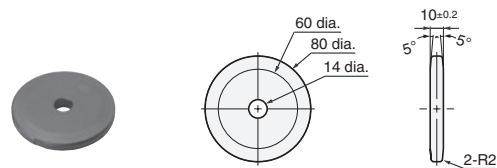

|                |           |
|----------------|-----------|
| <b>Coating</b> | PPS resin |
|----------------|-----------|

#### V680-D1KP52M-BT01 V680-D2KF52M-BT01

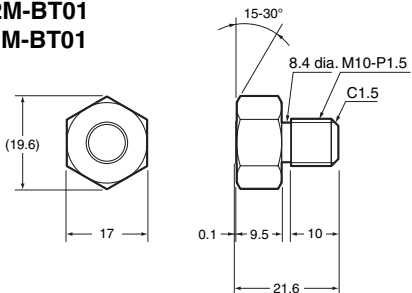

#### V680-D1KP52M-BT11 V680-D2KF52M-BT11

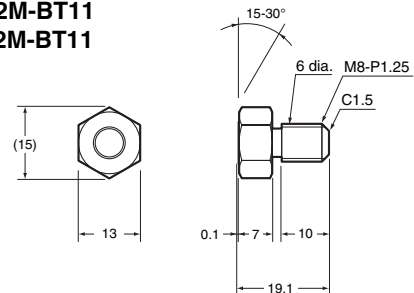

## Antenna with Detachable Amplifier Unit

### V680-HS52-W

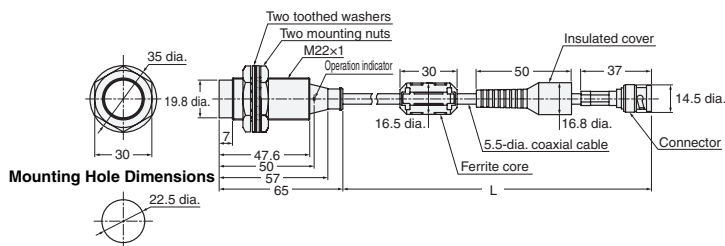

| Cable length                | L dimension                           |
|-----------------------------|---------------------------------------|
| 2 m                         | 2,000 <sup>+100</sup> <sub>-50</sub>  |
| 12.5 m                      | 12,500 <sup>+200</sup> <sub>-50</sub> |
| <b>Case material</b>        | Brass                                 |
| <b>Transmission surface</b> | ABS resin                             |
| <b>Filling</b>              | Epoxy resin                           |
| <b>Cable</b>                | PVC                                   |

### V680-HS52-R

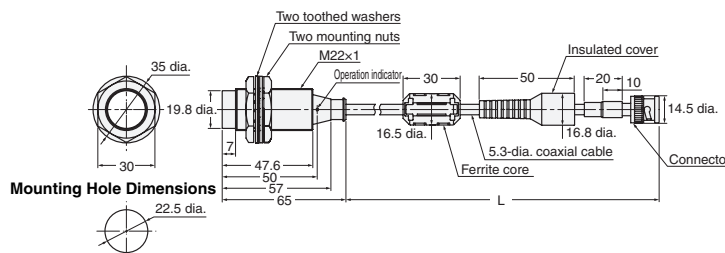

| Cable length                | L dimension                           |
|-----------------------------|---------------------------------------|
| 2 m                         | 2,000 <sup>+100</sup> <sub>-50</sub>  |
| 12.5 m                      | 12,500 <sup>+200</sup> <sub>-50</sub> |
| <b>Case material</b>        | Brass                                 |
| <b>Transmission surface</b> | ABS resin                             |
| <b>Filling</b>              | Epoxy resin                           |
| <b>Cable</b>                | PVC                                   |

### V680-HS51

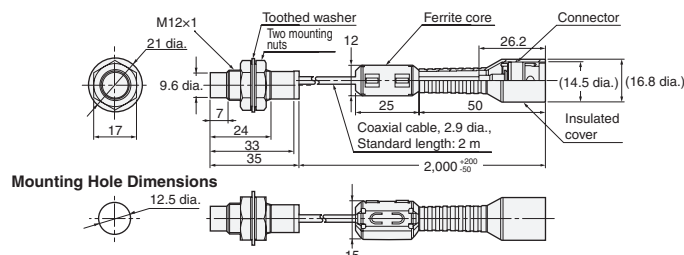

|                             |             |
|-----------------------------|-------------|
| <b>Case material</b>        | Brass       |
| <b>Transmission surface</b> | ABS resin   |
| <b>Filling</b>              | Epoxy resin |
| <b>Cable</b>                | PVC         |

### V680-HS63-W

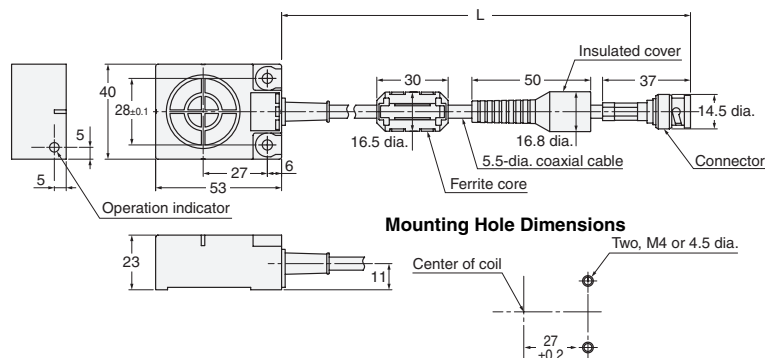

| Cable length         | L dimension                           |
|----------------------|---------------------------------------|
| 2 m                  | 2,000 <sup>+100</sup> <sub>-50</sub>  |
| 12.5 m               | 12,500 <sup>+200</sup> <sub>-50</sub> |
| <b>Case material</b> | ABS resin                             |
| <b>Filling</b>       | Epoxy resin                           |
| <b>Cable</b>         | PVC                                   |

### V680-HS63-R

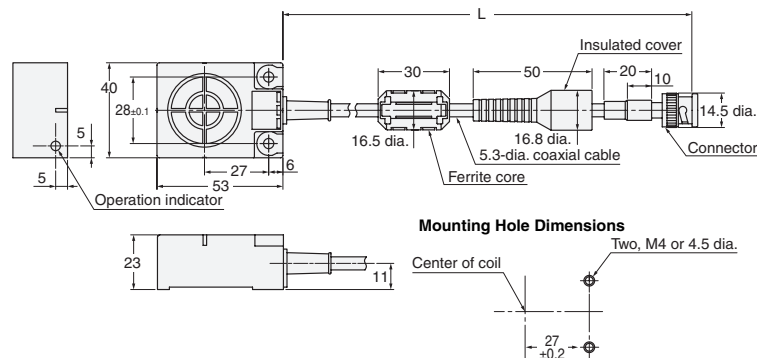

| Cable length         | L dimension                           |
|----------------------|---------------------------------------|
| 2 m                  | 2,000 <sup>+100</sup> <sub>-50</sub>  |
| 12.5 m               | 12,500 <sup>+200</sup> <sub>-50</sub> |
| <b>Case material</b> | ABS resin                             |
| <b>Filling</b>       | Epoxy resin                           |
| <b>Cable</b>         | PVC                                   |

V680-HS65-W

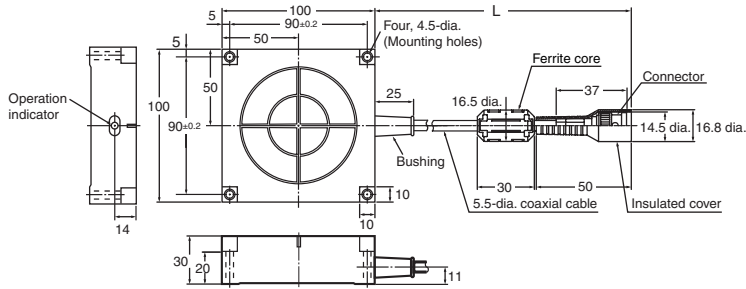

| Cable length         | L dimension                           |
|----------------------|---------------------------------------|
| 2 m                  | 2,000 <sup>+100</sup> <sub>-50</sub>  |
| 12.5 m               | 12,500 <sup>+200</sup> <sub>-50</sub> |
| <b>Case material</b> | ABS resin                             |
| <b>Filling</b>       | Epoxy resin                           |
| <b>Cable</b>         | PVC (gray)                            |

V680-HS65-R

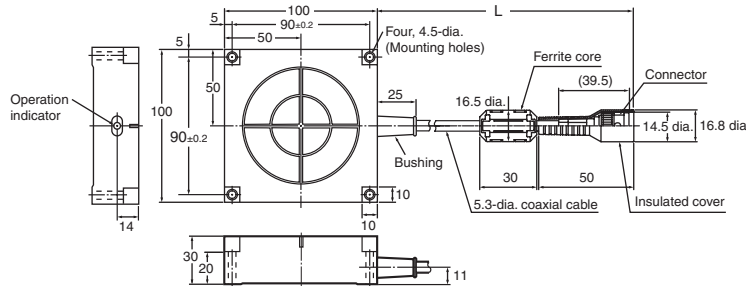

| Cable length         | L dimension                           |
|----------------------|---------------------------------------|
| 2 m                  | 2,000 <sup>+100</sup> <sub>-50</sub>  |
| 12.5 m               | 12,500 <sup>+200</sup> <sub>-50</sub> |
| <b>Case material</b> | ABS resin                             |
| <b>Filling</b>       | Epoxy resin                           |
| <b>Cable</b>         | PVC (black)                           |

Antenna with Built-in Amplifier Unit

V680-H01-V2

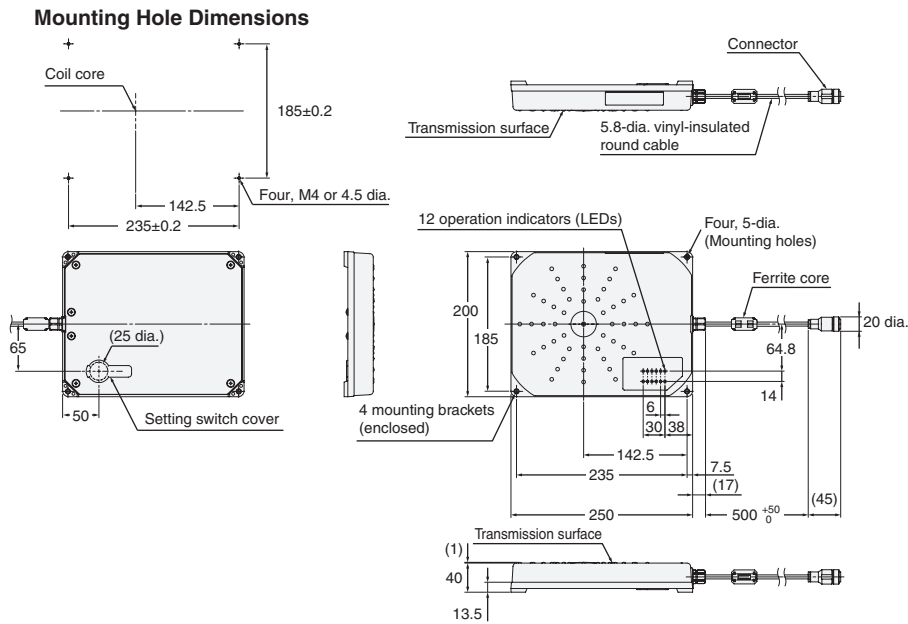

|                      |              |
|----------------------|--------------|
| <b>Case material</b> | PC/ASA resin |
| <b>Filling</b>       | Aluminum     |
| <b>Cable</b>         | PVC          |

Amplifier Unit

V680-HA63A/-HA63B

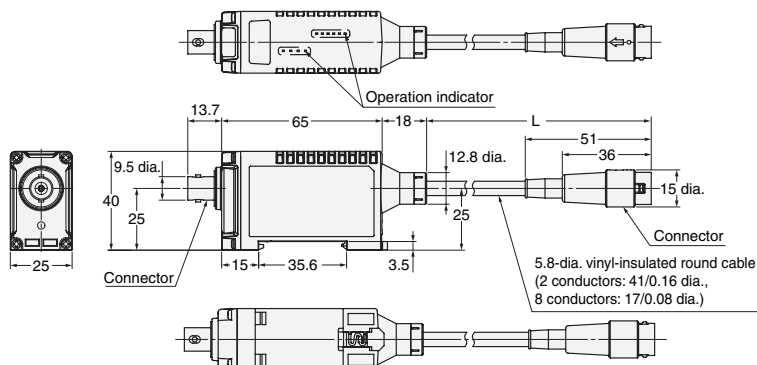

| Cable length         | L dimension                            |
|----------------------|--|
| 0.5 m                | 500 <sup>+100</sup> <sub>-50</sub>     |
| 5 m                  | 5,000 <sup>+100</sup> <sub>-50</sub>   |
| 10 m                 | 10,000 <sup>+200</sup> <sub>-100</sub> |
| <b>Case material</b> | PC resin                               |
| <b>Filling</b>       | Epoxy resin                            |
| <b>Cable</b>         | PVC                                    |



ID Controller

V680-CA5D01-V2/-CA5D02-V2

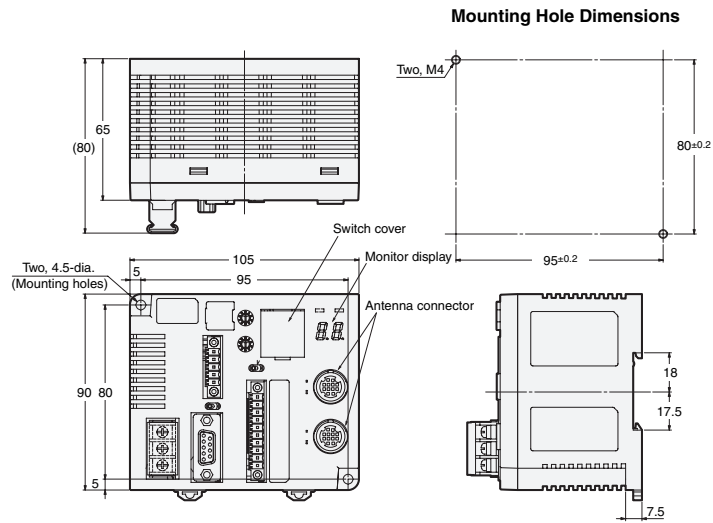

ID Sensor Units

CJ1W-V680C11

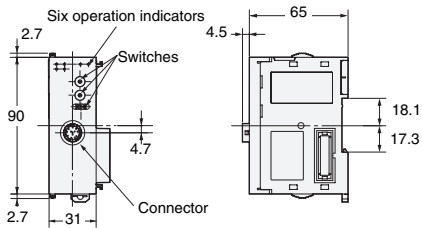

CS1W-V680C11

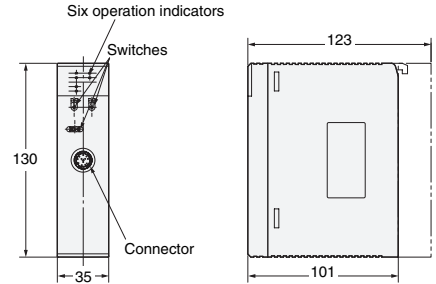

CJ1W-V680C12

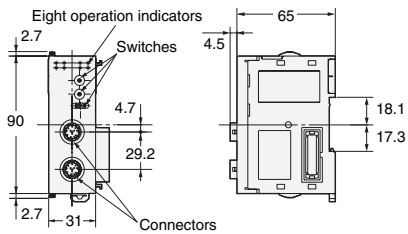

CS1W-V680C12

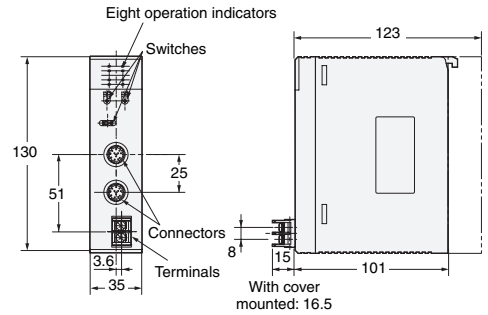

Amplifier-integrated Controller (DeviceNet ID Slave/PROFIBUS ID Slave)

V680-HAM42-DRT

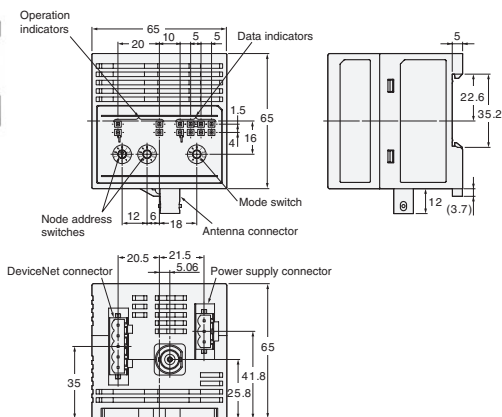

Case material PC+ABS resin

V680-HAM42-PRT

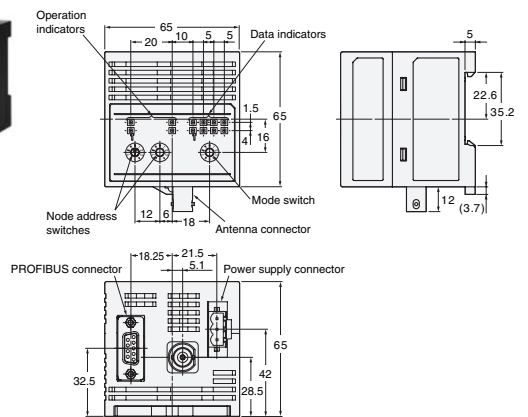

Case material PC+ABS resin

Amplifier-integrated Controllers (ID Flag Sensors)

V680-HAM91/-HAM81

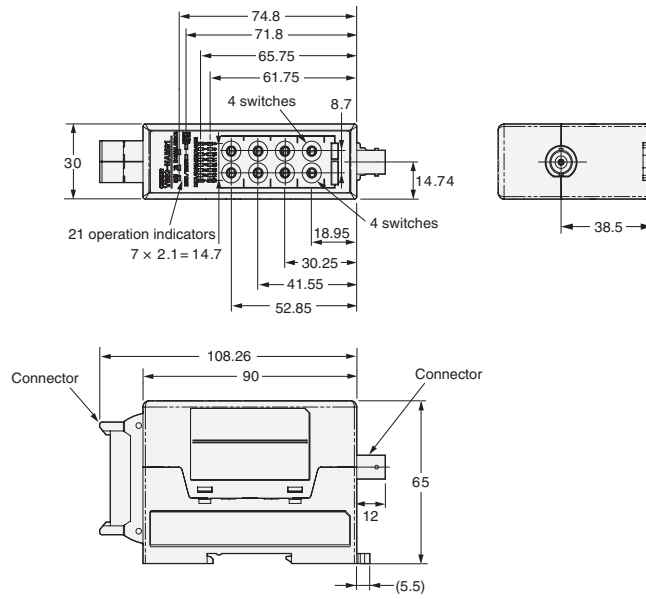

|               |              |
|---------------|--------------|
| Case material | PC+ABS resin |
|---------------|--------------|

Handheld Reader Writer

V680-CHUD

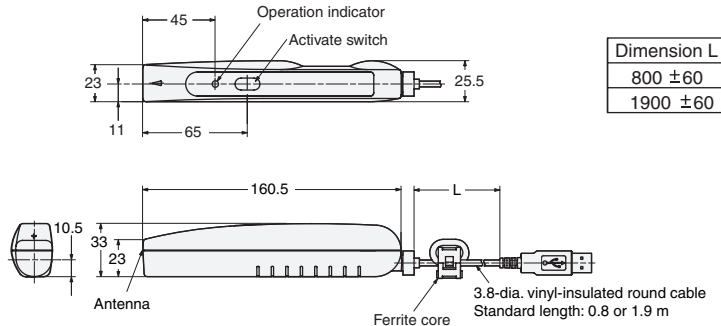

|               |           |
|---------------|-----------|
| Case material | ABS resin |
| Cable         | PVC       |

V680-CH1D

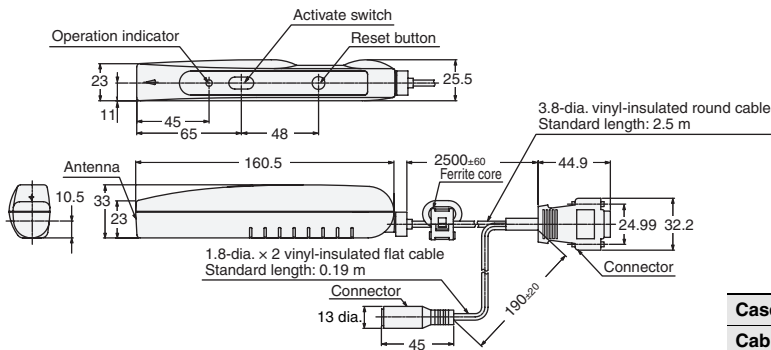

|               |           |
|---------------|-----------|
| Case material | ABS resin |
| Cable         | PVC       |

V680-CH1D-PSI

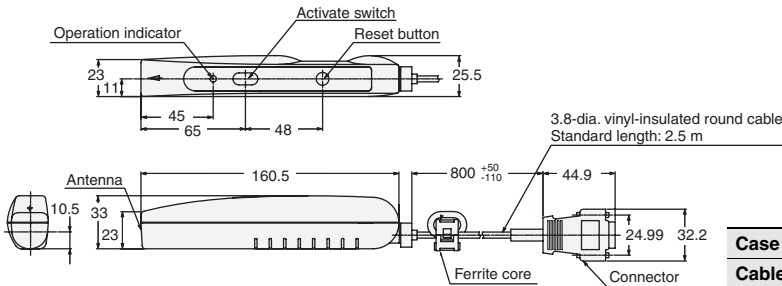

|               |           |
|---------------|-----------|
| Case material | ABS resin |
| Cable         | PVC       |

Interface Cables (Sold Separately)

V680-A60 2M/5M/10M

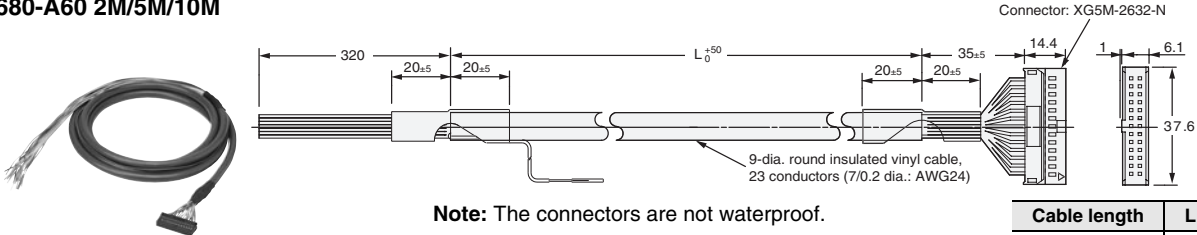

| Cable length | L dimension |
|--------------|-------------|
| 2 m          | 2,000       |
| 5 m          | 5,000       |
| 10 m         | 10,000      |

AC Adapter

V600-A22

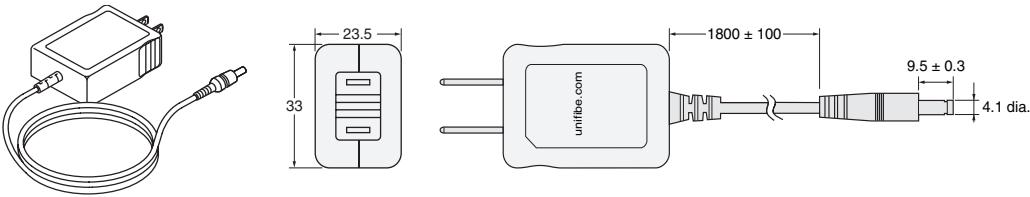

Handheld Terminal (Recommended)

Recommended Handheld Terminal  
Psion Teklogix model 7527S-G3-□□-S  
(V680-A-7527S-G3-□□-S)

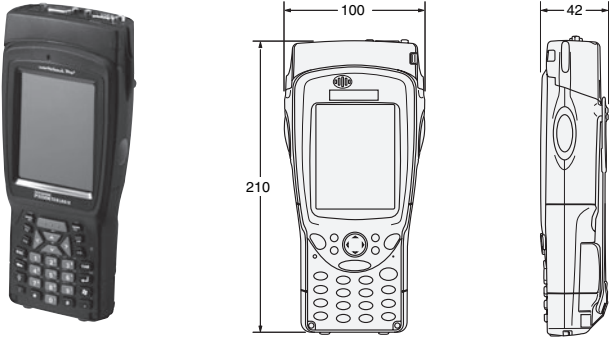

Accessories

V680-D1KP66T Attachments  
V600-A86

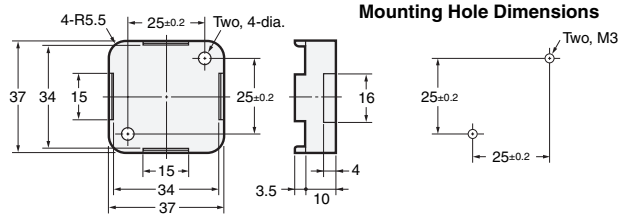

|               |           |
|---------------|-----------|
| Case material | PPS resin |
|---------------|-----------|

V680-D8KF68/-D32KF68 Attachments  
V680-A81

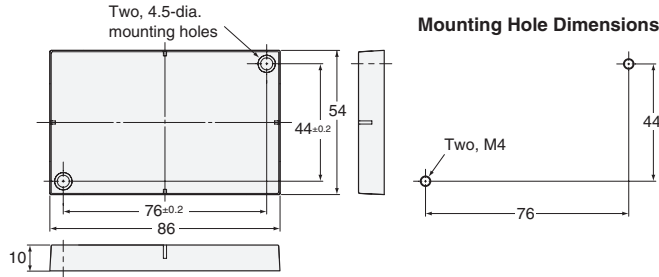

|               |             |
|---------------|-------------|
| Case material | PBT resin   |
| Filling       | Epoxy resin |

V680-D1KP58HT Attachments  
V680-A80

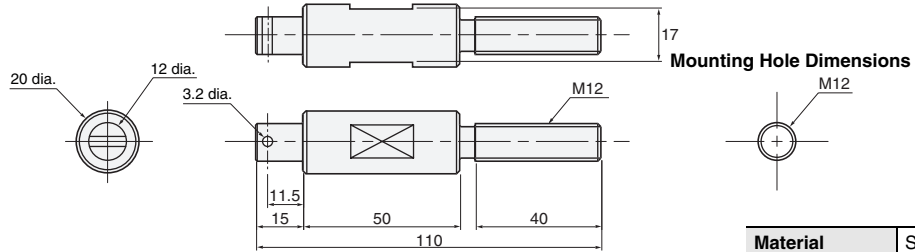

|          |                 |
|----------|-----------------|
| Material | Stainless steel |
|----------|-----------------|

V680-D1KP54T Attachments  
V700-A80

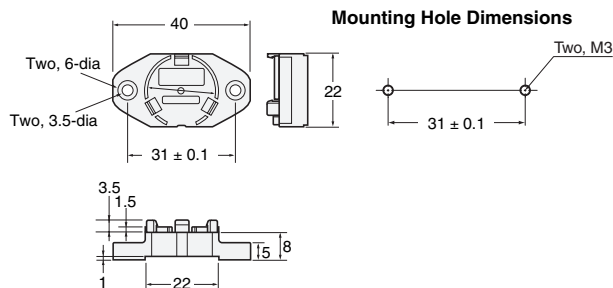

Amplifier Unit Special Extension Cable

- V700-A40 2M
- V700-A41 3M
- V700-A42 5M
- V700-A43 10M
- V700-A44 20M
- V700-A45 30M

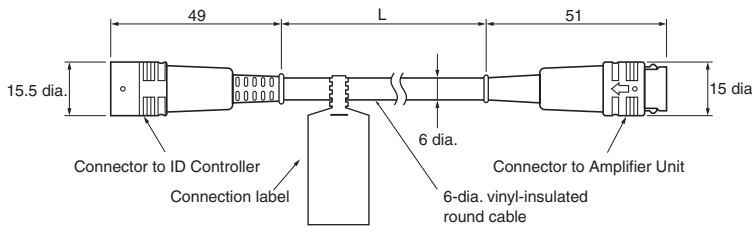

| Cable length | L dimension |
|--------------|-------------|
| 2 m          | 2,000±100   |
| 3 m          | 3,000±100   |
| 5 m          | 5,000±100   |
| 10 m         | 10,000±100  |
| 20 m         | 20,000±100  |
| 30 m         | 30,000±100  |
| Material     | PVC         |

V680-H01 Special Cables

- V700-A40-W 2M
- V700-A40-W 5M
- V700-A40-W 10M
- V700-A40-W 20M
- V700-A40-W 30M

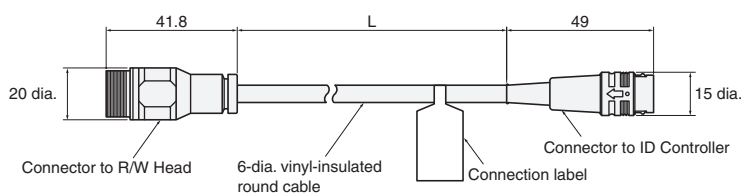

| Cable length | L dimension |
|--------------|-------------|
| 2 m          | 2,000±100   |
| 5 m          | 5,000±100   |
| 10 m         | 10,000±100  |
| 20 m         | 20,000±100  |
| 30 m         | 30,000±100  |
| Material     | PVC         |

## Read and Understand This Catalog

Please read and understand this catalog before purchasing the products. Please consult your OMRON representative if you have any questions or comments.

## Warranty and Limitations of Liability

### WARRANTY

OMRON's exclusive warranty is that the products are free from defects in materials and workmanship for a period of one year (or other period if specified) from date of sale by OMRON.

OMRON MAKES NO WARRANTY OR REPRESENTATION, EXPRESS OR IMPLIED, REGARDING NON-INFRINGEMENT, MERCHANTABILITY, OR FITNESS FOR PARTICULAR PURPOSE OF THE PRODUCTS. ANY BUYER OR USER ACKNOWLEDGES THAT THE BUYER OR USER ALONE HAS DETERMINED THAT THE PRODUCTS WILL SUITABLY MEET THE REQUIREMENTS OF THEIR INTENDED USE. OMRON DISCLAIMS ALL OTHER WARRANTIES, EXPRESS OR IMPLIED.

### LIMITATIONS OF LIABILITY

OMRON SHALL NOT BE RESPONSIBLE FOR SPECIAL, INDIRECT, OR CONSEQUENTIAL DAMAGES, LOSS OF PROFITS OR COMMERCIAL LOSS IN ANY WAY CONNECTED WITH THE PRODUCTS, WHETHER SUCH CLAIM IS BASED ON CONTRACT, WARRANTY, NEGLIGENCE, OR STRICT LIABILITY.

In no event shall the responsibility of OMRON for any act exceed the individual price of the product on which liability is asserted.

IN NO EVENT SHALL OMRON BE RESPONSIBLE FOR WARRANTY, REPAIR, OR OTHER CLAIMS REGARDING THE PRODUCTS UNLESS OMRON'S ANALYSIS CONFIRMS THAT THE PRODUCTS WERE PROPERLY HANDLED, STORED, INSTALLED, AND MAINTAINED AND NOT SUBJECT TO CONTAMINATION, ABUSE, MISUSE, OR INAPPROPRIATE MODIFICATION OR REPAIR.

## Application Considerations

### SUITABILITY FOR USE

OMRON shall not be responsible for conformity with any standards, codes, or regulations that apply to the combination of products in the customer's application or use of the products.

At the customer's request, OMRON will provide applicable third party certification documents identifying ratings and limitations of use that apply to the products. This information by itself is not sufficient for a complete determination of the suitability of the products in combination with the end product, machine, system, or other application or use.

The following are some examples of applications for which particular attention must be given. This is not intended to be an exhaustive list of all possible uses of the products, nor is it intended to imply that the uses listed may be suitable for the products:

- Outdoor use, uses involving potential chemical contamination or electrical interference, or conditions or uses not described in this catalog.
- Nuclear energy control systems, combustion systems, railroad systems, aviation systems, medical equipment, amusement machines, vehicles, safety equipment, and installations subject to separate industry or government regulations.
- Systems, machines, and equipment that could present a risk to life or property.

Please know and observe all prohibitions of use applicable to the products.

NEVER USE THE PRODUCTS FOR AN APPLICATION INVOLVING SERIOUS RISK TO LIFE OR PROPERTY WITHOUT ENSURING THAT THE SYSTEM AS A WHOLE HAS BEEN DESIGNED TO ADDRESS THE RISKS, AND THAT THE OMRON PRODUCTS ARE PROPERLY RATED AND INSTALLED FOR THE INTENDED USE WITHIN THE OVERALL EQUIPMENT OR SYSTEM.

### PROGRAMMABLE PRODUCTS

OMRON shall not be responsible for the user's programming of a programmable product, or any consequence thereof.

## Disclaimers

### CHANGE IN SPECIFICATIONS

Product specifications and accessories may be changed at any time based on improvements and other reasons.

It is our practice to change model numbers when published ratings or features are changed, or when significant construction changes are made. However, some specifications of the products may be changed without any notice. When in doubt, special model numbers may be assigned to fix or establish key specifications for your application on your request. Please consult with your OMRON representative at any time to confirm actual specifications of purchased products.

### DIMENSIONS AND WEIGHTS

Dimensions and weights are nominal and are not to be used for manufacturing purposes, even when tolerances are shown.

### PERFORMANCE DATA

Performance data given in this catalog is provided as a guide for the user in determining suitability and does not constitute a warranty. It may represent the result of OMRON's test conditions, and the users must correlate it to actual application requirements. Actual performance is subject to the OMRON Warranty and Limitations of Liability.

### ERRORS AND OMISSIONS

The information in this document has been carefully checked and is believed to be accurate; however, no responsibility is assumed for clerical, typographical, or proofreading errors, or omissions.

2012.2

In the interest of product improvement, specifications are subject to change without notice.

**OMRON Corporation**  
Industrial Automation Company

<http://www.ia.omron.com/>

(c)Copyright OMRON Corporation 2012 All Right Reserved.

## Данный компонент на территории Российской Федерации

### Вы можете приобрести в компании MosChip.

Для оперативного оформления запроса Вам необходимо перейти по данной ссылке:

<http://moschip.ru/get-element>

Вы можете разместить у нас заказ для любого Вашего проекта, будь то серийное производство или разработка единичного прибора.

В нашем ассортименте представлены ведущие мировые производители активных и пассивных электронных компонентов.

Нашей специализацией является поставка электронной компонентной базы двойного назначения, продукции таких производителей как XILINX, Intel (ex.ALTERA), Vicor, Microchip, Texas Instruments, Analog Devices, Mini-Circuits, Amphenol, Glenair.

Сотрудничество с глобальными дистрибьюторами электронных компонентов, предоставляет возможность заказывать и получать с международных складов практически любой перечень компонентов в оптимальные для Вас сроки.

На всех этапах разработки и производства наши партнеры могут получить квалифицированную поддержку опытных инженеров.

Система менеджмента качества компании отвечает требованиям в соответствии с ГОСТ Р ИСО 9001, ГОСТ РВ 0015-002 и ЭС РД 009

### Офис по работе с юридическими лицами:

105318, г.Москва, ул.Щербаковская д.3, офис 1107, 1118, ДЦ «Щербаковский»

Телефон: +7 495 668-12-70 (многоканальный)

Факс: +7 495 668-12-70 (доб.304)

E-mail: [info@moschip.ru](mailto:info@moschip.ru)

Skype отдела продаж:

moschip.ru

moschip.ru\_4

moschip.ru\_6

moschip.ru\_9