

100V V_{IN} and V_{OUT} Synchronous 4-Switch Buck-Boost DC/DC Controller with Pass-Thru

FEATURES

- Pin-Selectable Pass-Thru or Fixed Output CCM, DCM, Burst Mode® Operation
- Programmable Non-Switching Pass-Thru Window
- 18 μ A Pass-Thru Mode I_Q with 99.9% Efficiency
- V_{IN} Range: 2.8V to 100V (4.5V for Start-Up)
- V_{OUT} Range: 1V to 100V
- Reverse Input Protection to -40V
- $\pm 1.25\%$ Output Voltage Accuracy (-40°C to 125°C)
- $\pm 3\%$ Accurate Current Monitoring
- $\pm 5\%$ Accurate Current Regulation
- 10V Quad N-Channel MOSFET Gate Drivers
- EXTV_{CC} LDO Powers Drivers from V_{OUT} /External Rail
- $\pm 20\%$ Cycle-by-Cycle Inductor Current Limit
- No Top MOSFET Refresh Noise in Buck or Boost
- Fixed/Phase-Lockable Frequency: 80kHz to 400kHz
- Spread Spectrum Frequency Modulation for Low EMI
- Power Good Output Voltage/Overcurrent Monitor
- Available in a 38-Lead TSSOP and 40-Lead (6mm x 6mm) QFN Packages

APPLICATIONS

- Automotive, Industrial, Telecom, Avionics Systems
- Automotive Start-Stop, Emergency Call Applications
- ISO 7637, ISO 16750, MIL-1275, DO-160 Applications

DESCRIPTION

The LT[®]8210 is a 4-switch synchronous buck-boost DC/DC controller that can operate in pass-thru, forced continuous, pulse-skipping and Burst Mode[®] operation. Pass-Thru is a feature that passes the input directly to the output when the input is within a user programmable window. Pass-Thru mode eliminates switching losses and EMI along with maximizing efficiency. For input voltages above or below the pass-thru window, the buck or boost regulation loops maintain the output at the set maximum or minimum values, respectively.

The GATEV_{CC} driver supply is regulated to 10.6V allowing the use of standard-level MOSFETs and can be powered through the EXTV_{CC} pin for improved efficiency. The GATEV_{CC} regulator is back-drive-protected to ride through input brownouts while maintaining regulation. Optional reverse input protection down to -40V can be implemented with the addition of a single N-channel MOSFET. The LT8210 includes a precision current sense amplifier that can accurately monitor and limit output or input average current.

All registered trademarks and trademarks are the property of their respective owners. Protected by U.S. patents, including 10135340.

TYPICAL APPLICATION

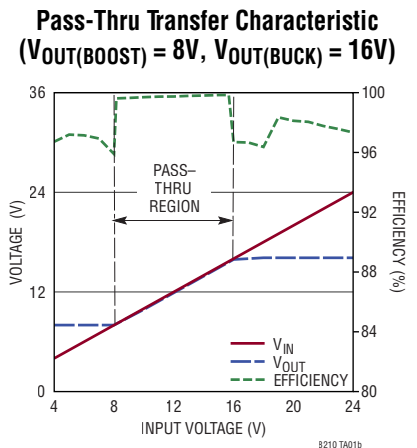
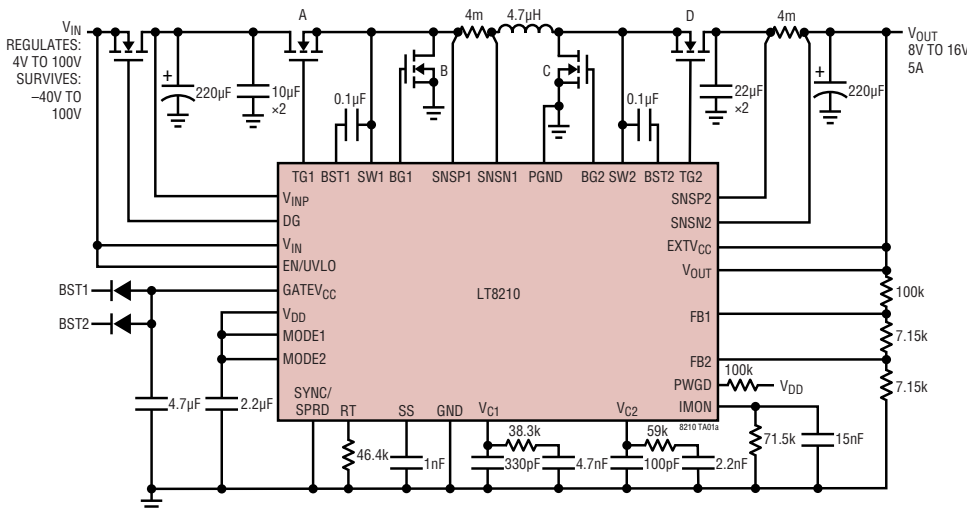

TABLE OF CONTENTS

Features	1	Reverse Input Protection	20
Applications	1	Current Monitoring and Regulation	20
Typical Application	1	Buck Foldback.....	21
Description	1	Bootstrap Capacitor Voltage	21
Table of Contents	2	PWGD Pin.....	22
Absolute Maximum Ratings	3	Applications Information	23
Pin Configuration	3	Maximum Output Current and R _{SENSE} Selection	23
Order Information	3	Inductor Selection.....	24
Electrical Characteristics	4	Switching Frequency Selection.....	25
Typical Performance Characteristics	7	RT Set Switching Frequency.....	25
Pin Functions	12	Frequency Synchronization.....	26
Block Diagram	14	Spread-Spectrum Frequency Modulation.....	26
Operation	15	Power MOSFET Selection	27
Overview.....	15	C _{IN} and C _{OUT} Selection	28
Continuous Conduction Mode (CCM)	15	Bootstrap Capacitors (C _{BST1} , C _{BST2})	29
Discontinuous Conduction Mode (DCM)	15	Bootstrap Diodes (D _{BST1} , D _{BST2}).....	30
Burst Mode Operation.....	15	EXTV _{CC} , GATEV _{CC} and V _{DD}	30
Pass-Thru Mode	15	Programming Output Voltage	31
Power Switch Control (CCM, DCM, Burst		Programming Input or Output Current Limit.....	31
Mode Operation).....	16	Programming V _{IN} UVLO	33
Power Switch Control: Buck Region		Soft-Start.....	33
(V _{INP} > 1.19 • V _{OUT}).....	17	Loop Compensation	33
Power Switch Control: Boost Region		Optional DG MOSFET Selection	34
(V _{INP} < 0.84 • V _{OUT})	17	Component Optimization for Pass-Thru Operation	34
Power Switch Control: Buck-Boost Region		Efficiency Considerations	35
(0.84 • V _{OUT} < V _{INP} < 1.19 • V _{OUT})	17	PC Board Layout Checklist	36
Power Switch Control (Pass-Thru Mode).....	18	Typical Applications	38
Transitioning Between Operating Modes	18	Revision History	45
Enable and Start-Up.....	19	Typical Application	46
EXTV _{CC} /GATEV _{CC} /V _{DD} Power Supplies	19	Related Parts	46

ABSOLUTE MAXIMUM RATINGS

(Note 1)

V_{IN} , EN/UVLO Voltage.....	-40V to 100V
DG Voltage.....	-40V to 113V
DG – V_{IN} Voltage.....	-0.3V to 13V
V_{INP} , V_{OUT} , SNSP2, SNSN2 Voltage.....	-0.3V to 100V
SNSP1 – SNSN1, SNSP2 – SNSN2 Voltage....	-0.5V to 0.5V
BST1, BST2 Voltage.....	-0.3V to 115V
SW1, SW2, SNSP1, SNSN1 Voltage.....	100V (Note 5)
BST1 – SW1, BST2 – SW2 Voltage.....	-0.3V to 15V
BST1 – SNSP1, BST1 – SNSN1 Voltage.....	-0.3V to 15V
TG1, TG2, BG1, BG2.....	(Note 3)

GATEV _{CC} Voltage.....	-0.3V to 15V
EXTV _{CC} , PWGD Voltage.....	-0.3V to 40V
MODE1, MODE2, SYNC/SPRD Voltage.....	-0.3V to 6V
FB1, FB2, IMON, RT Voltage.....	-0.3V to 6V
V_{DD}	-0.3V to 6V
V_{C1} , V_{C2} , SS Voltage.....	-0.3V to V_{DD} (Note 6)
Operating Junction Temperature	
LT8210E, LT8210I (Notes 2, 4).....	-40°C to 125°C
Storage Temperature Range.....	-65°C to 150°C
Lead Temperature (Soldering, 10 sec).....	300°C

PIN CONFIGURATION

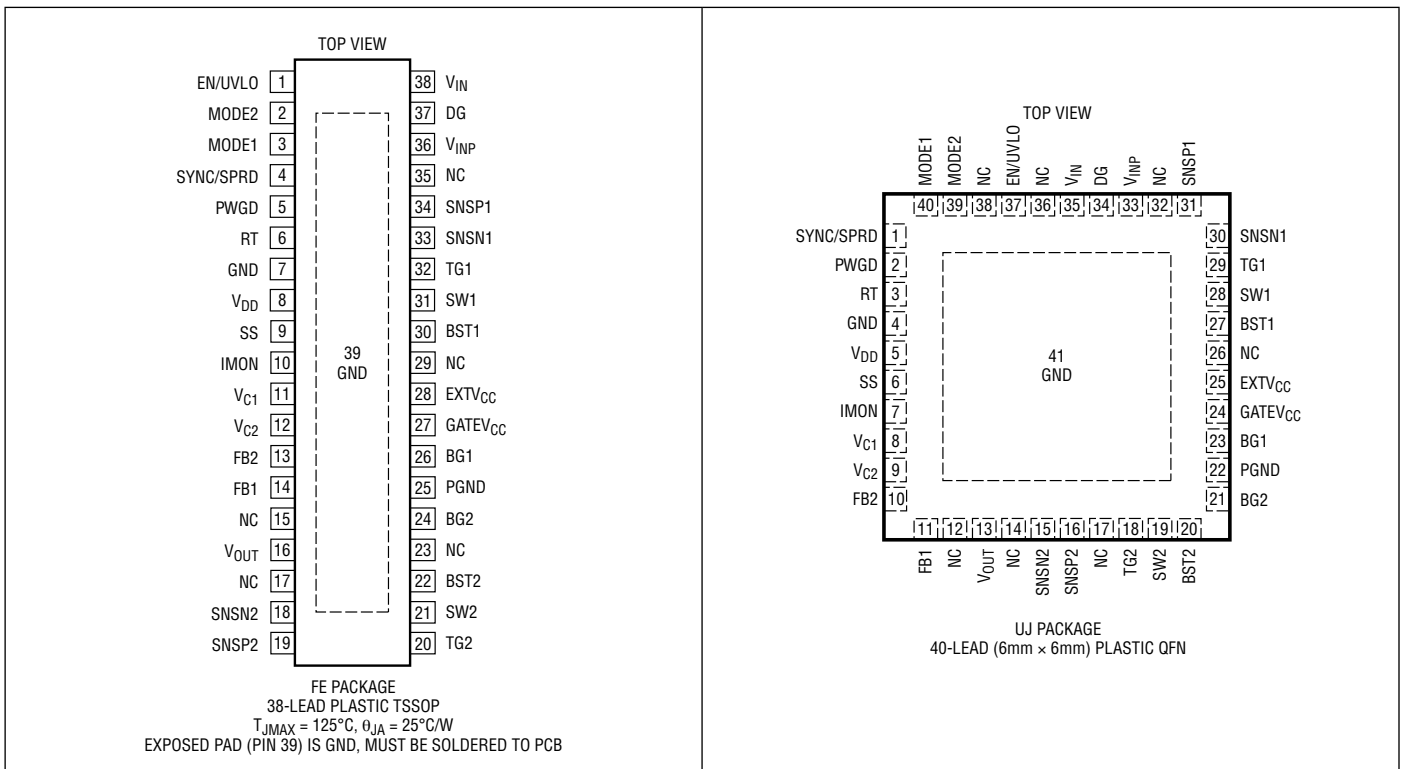

ORDER INFORMATION

LEAD FREE FINISH	TAPE AND REEL	PART MARKING	PACKAGE DESCRIPTION	TEMPERATURE RANGE
LT8210EFE#PBF	LT8210EFE#TRPBF	LT8210FE	38-Lead Plastic TSSOP	-40°C to 125°C
LT8210IFE#PBF	LT8210IFE#TRPBF	LT8210FE	38-Lead Plastic TSSOP	-40°C to 125°C
LT8210EUJ#PBF	LT8210EUJ#TRPBF	8210UJ	40-Lead (6mm x 6mm) Plastic QFN	-40°C to 125°C
LT8210IUJ#PBF	LT8210IUJ#TRPBF	8210UJ	40-Lead (6mm x 6mm) Plastic QFN	-40°C to 125°C

Contact the factory for parts specified with wider operating temperature ranges. *The temperature grade is identified by a label on the shipping container. [Tape and reel specifications](#). Some packages are available in 500 unit reels through designated sales channels with #TRMPBF suffix.

ELECTRICAL CHARACTERISTICS

The ● denotes the specifications which apply over the full operating temperature range, otherwise specifications are at $T_A = 25^\circ\text{C}$. $V_{IN} = 12\text{V}$, $V_{INP} = 12\text{V}$, $V_{EN/UVLO} = 3.3\text{V}$

PARAMETER	CONDITIONS		MIN	TYP	MAX	UNITS
Voltage Supplies and Regulators						
V_{IN} , V_{INP} Input Operating Voltage Range	Minimum Voltage for Start-Up ($V_{EXTVCC} = 0\text{V}$)	●	4.5		100	V
	After Start-Up, $V_{EXTVCC} = 12\text{V}$	●	2.8		100	V
V_{IN} Quiescent Current	Shutdown ($V_{EN/UVLO} = 0\text{V}$)	●		1	5	μA
	Not Switching	●		4	15	μA
	Internal Charge Pump Enabled ($V_{DG} - V_{IN} = 3.5\text{V}$)	●		1400	1800	μA
V_{INP} Quiescent Current	Shutdown ($V_{EN/UVLO} = 0\text{V}$)	●		0.1	1.0	μA
	Not Switching	●		650	1300	μA
	Internal Charge Pump Enabled ($V_{DG} - V_{IN} = 3.5\text{V}$)	●		1900	2700	μA
	Burst Mode Operation (Sleep)	●		65	90	μA
	Pass-Thru (Non-Switching, $V_{INP} = 48\text{V}$)	●		18	33	μA
V_{OUT} Quiescent Current	$V_{OUT} = 12\text{V}$	●		1.5	3	μA
$GATEV_{CC}$ Voltage	$I_{GATEVCC} = 25\text{mA}$	●	10	10.6	11.2	V
$GATEV_{CC}$ Current Limit	Regulated from V_{INP} , $V_{INP} = 12\text{V}$, $V_{GATEVCC} = 9\text{V}$	●	65	110		mA
	Regulated from V_{INP} , $V_{INP} = 100\text{V}$, $V_{GATEVCC} = 9\text{V}$	●	18	25		mA
	Regulated from $EXTV_{CC}$, $V_{EXTVCC} = 12\text{V}$, $V_{GATEVCC} = 9\text{V}$	●	80	115		mA
	Regulated from $EXTV_{CC}$, $V_{EXTVCC} = 40\text{V}$, $V_{GATEVCC} = 9\text{V}$	●	55	90		mA
$GATEV_{CC}$ Load Regulation	$I_{GATEVCC} = 0\text{mA}$ to 50mA	●		1.8	5	%
$GATEV_{CC}$ Regulator Dropout Voltage	$V_{INP} - V_{GATEVCC}$: $I_{GATEVCC} = 50\text{mA}$	●		750	1600	mV
	$V_{EXTVCC} - V_{GATEVCC}$: $I_{GATEVCC} = 50\text{mA}$	●		600	1400	mV
$GATEV_{CC}$ Undervoltage Lockout Threshold	Falling	●	3.65	3.75	3.85	V
$GATEV_{CC}$ Undervoltage Lockout Hysteresis				0.20		V
$GATEV_{CC}$ Backdrive Current	To V_{INP} Pin, $V_{GATEVCC} = 10\text{V}$, $V_{INP} = 0\text{V}$			20		μA
	To $EXTV_{CC}$ Pin, $V_{GATEVCC} = 10\text{V}$, $V_{EXTVCC} = 0\text{V}$			3		μA
$EXTV_{CC}$ Switchover Voltage	Rising	●	7.3	8	8.8	V
$EXTV_{CC}$ Switchover Hysteresis				1.2		V
V_{DD} Voltage		●	3.2	3.3	3.4	V
V_{DD} Current Limit	$V_{DD} = 3\text{V}$		10			mA
V_{DD} Undervoltage Lockout Threshold	Falling	●	2.7	2.8	2.9	V
V_{DD} Undervoltage Lockout Hysteresis				140		mV
Enable Comparator						
EN/UVLO Enable Threshold	Rising	●	1.28	1.45	1.61	V
EN/UVLO Enable Hysteresis				100		mV
EN/UVLO Pin Bias Current	$V_{EN/UVLO} = 100\text{V}$	●		0.08	0.3	μA
Reverse Input Protection						
DG Gate Drive Voltage ($V_{DG} - V_{IN}$)	Non-Switching	●	7.0	8.5		V
Reverse Input Disconnect Threshold (V_{IN})	$I_{DG} = 100\ \mu\text{A}$	●	-1.8	-1.2	-0.5	V
DG Pin Pull-Down Current	$V_{IN} = -4\text{V}$, $V_{DG} - V_{IN} = 5\text{V}$	●	50	80	130	mA
DG Pin Pull-Up Current	$V_{DG} - V_{IN} = 1.5\text{V}$	●	100	180		μA
	$V_{DG} - V_{IN} = 8.5\text{V}$	●	5	25		μA
DG Undervoltage Threshold ($V_{DG} - V_{IN}$)	Rising	●	2.3	2.8	3	V
DG Undervoltage Hysteresis ($V_{DG} - V_{IN}$)				700		mV
Voltage Regulation						
FB1 Regulation Voltage	Regulation Voltage for CCM, DCM, Burst Mode Operation, Pass-Thru Mode Boost Loop	●	0.9875	1.00	1.0125	V

ELECTRICAL CHARACTERISTICS The ● denotes the specifications which apply over the full operating temperature range, otherwise specifications are at $T_A = 25^\circ\text{C}$. $V_{IN} = 12\text{V}$, $V_{INP} = 12\text{V}$, $V_{EN/UVLO} = 3.3\text{V}$

PARAMETER	CONDITIONS		MIN	TYP	MAX	UNITS
FB2 Regulation Voltage	Regulation Voltage Pass-Thru Mode Buck Loop	●	0.985	1.00	1.015	V
FB1, FB2 Input Bias Current		●		0.001	0.04	μA
FB1, FB2 Line Regulation	$V_{INP} = 3\text{V to } 100\text{V}$	●		0.001	0.007	%/V
FB1, FB2 Error Amplifier Transconductance				450		$\mu\text{A/V}$
V_{C1} , V_{C2} Output Impedance				5		$\text{M}\Omega$
V_{C1} , V_{C2} Maximum Sourcing Current	$V_{FB1} = V_{FB2} = 0\text{V}$			35		μA
V_{C1} , V_{C2} Maximum Sinking Current	$V_{FB1} = V_{FB2} = 2\text{V}$			-35		μA
Soft-Start Charging Current	$V_{SS} = 0.5\text{V}$	●	4	5	6	μA
Soft-Start Pull-Down Resistance		●		140	250	Ω

Average Current Monitoring and Regulation

SNSP2, SNSN2 Operating Voltage Range		●	0		100	V
SNSP2, SNSN2 Pin Bias Current	$V_{SNSP2} = V_{SNSN2} = 100\text{V}$	●		1	3	μA
	$V_{SNSP2} = V_{SNSN2} = 0\text{V}$	●	-3	0		μA
IMON Output Current Common Mode Voltage = 12V	$V_{SNSP2} - V_{SNSN2} = 150\text{mV}$	●	87.3	90	92.7	μA
	$V_{SNSP2} - V_{SNSN2} = 50\text{mV}$	●	28.6	30	31.4	μA
	$V_{SNSP2} - V_{SNSN2} = 10\text{mV}$	●	5.1	6	6.6	μA
IMON Output Current Common Mode Voltage = 0V	$V_{SNSP2} - V_{SNSN2} = 150\text{mV}$	●	85	90.5	95	μA
	$V_{SNSP2} - V_{SNSN2} = 50\text{mV}$	●	27	30	33	μA
	$V_{SNSP2} - V_{SNSN2} = 10\text{mV}$	●	4	6	8.5	μA
Common Mode Switchover Voltage	$V_{SNSP2} = V_{SNSN2}$			1.8		V
IMON DC CMRR	$V_{SNSP2} - V_{SNSN2} = 150\text{mV}$, $V_{SNSP2} = 3\text{V to } 100\text{V}$			120		dB
IMON Error Amplifier Transconductance				200		$\mu\text{A/V}$
IMON Regulation Voltage (V_{IMON})		●	0.98	1.01	1.03	V
Sense Regulation Voltage ($V_{SNSP2} - V_{SNSN2}$)	$R_{IMON} = 33.2\text{k}$	●	48	50.5	53	mV
Over-Current Warning Threshold (V_{IMON})	Rising	●	1.15	1.2	1.24	V
Over-Current Warning Hysteresis				45		mV
IMON Disable Threshold (V_{IMON})	Rising	●	2.3	2.5	2.8	V
IMON Disable Hysteresis				400		mV

Cycle-by-Cycle Inductor Current Limiting

Maximum Current Sense Threshold ($V_{SNSP1} - V_{SNSN1}$)	Buck Regulation ($V_{INP} = 24\text{V}$, $V_{OUT} = 0\text{V}$)	●	45	53	60	mV
	Buck Regulation ($V_{INP} = 24\text{V}$, $V_{OUT} = 12\text{V}$)	●	55	62	69	mV
	Boost Regulation ($V_{INP} = 6\text{V}$, $V_{OUT} = 12\text{V}$)	●	45	51	58	mV
	Buck Regulation ($V_{INP} = 100\text{V}$, $V_{OUT} = 48\text{V}$)	●	73	85	96	mV
	Boost Regulation ($V_{INP} = 24\text{V}$, $V_{OUT} = 48\text{V}$)	●	36	45	54	mV
Maximum Non-Switching Current Sense Threshold in Pass-Thru ($V_{SNSP1} - V_{SNSN1}$)	$V_{OUT} = V_{INP}$ FB1 = 1.2V, FB2 = 0.8V MODE1 = MODE2 = 3.3V	●	57	63	70	mV
Reverse Current Sense Threshold ($V_{SNSP1} - V_{SNSN1}$)	DCM/Pass-Thru/Burst Mode Operation			3		mV
	Pass-Thru Buck-Boost Regions			-6		mV
Negative Current Sense Threshold ($V_{SNSP1} - V_{SNSN1}$)	CCM Operating Mode (MODE1 = MODE2 = 0V)			-55		mV

MOSFET Gate Drivers

TG1, TG2 Gate Driver Pull-Up Resistance				3		Ω
TG1, TG2 Gate Driver Pull-Down Resistance				1		Ω
BG1, BG2 Gate Driver Pull-Up Resistance				2.6		Ω

ELECTRICAL CHARACTERISTICS

The ● denotes the specifications which apply over the full operating temperature range, otherwise specifications are at $T_A = 25^\circ\text{C}$. $V_{IN} = 12\text{V}$, $V_{INP} = 12\text{V}$, $V_{EN/UVLO} = 3.3\text{V}$

PARAMETER	CONDITIONS	MIN	TYP	MAX	UNITS
BG1, BG2 Gate Driver Pull-Down Resistance			1		Ω
TG1, TG2 Rise Time	$C_{LOAD} = 3300\text{pF}$ (10% to 90%)		25		ns
TG1, TG2 Fall Time	$C_{LOAD} = 3300\text{pF}$ (10% to 90%)		15		ns
BG1, BG2 Rise Time	$C_{LOAD} = 3300\text{pF}$ (10% to 90%)		20		ns
BG1, BG2 Fall Time	$C_{LOAD} = 3300\text{pF}$ (10% to 90%)		15		ns
TG Off to BG On-Delay	$C_{LOAD} = 3300\text{pF}$		60		ns
BG Off to TG On-Delay	$C_{LOAD} = 3300\text{pF}$		60		ns
Minimum TG1 On-Time	$C_{LOAD} = 3300\text{pF}$		200		ns
Minimum BG2 On-Time	$C_{LOAD} = 3300\text{pF}$		220		ns
BST1, BST2 Bias Current	Top Gate High, $V_{BST} - V_{SW} = 10\text{V}$ Top Gate High, $V_{BST} - V_{SW} = 10\text{V}$, Pass-Thru Mode		5 0.6		μA μA
BST1, BST2 Charging Current	Non-Switching, $V_{BST} - V_{SW} = 8.25\text{V}$ Non-Switching, $V_{BST} - V_{SW} = 3\text{V}$		50 610		μA μA

Oscillator

Switching Frequency Range	RT Set/Synchronized	●	80		400	kHz
Switching Frequency	RT = 110k	●	91	100	108	kHz
	RT = 39.2k	●	190	200	210	kHz
	RT = 16.9k	●	380	400	420	kHz
SYNC/SPRD Input Low Level		●			0.8	V
SYNC/SPRD Input High Level		●	1.17			V
Spread-Spectrum Max. Frequency (% of f_{SW})	$V_{SYNC/SPRD} = 3.3\text{V}$			112.5		%
Spread-Spectrum Min. Frequency (% of f_{SW})	$V_{SYNC/SPRD} = 3.3\text{V}$			100		%

Logic Inputs/Outputs

MODE1,2 Input Low Level		●			0.8	V
MODE1,2 Input High Level		●	1.17			V
MODE1,2 Leakage Current	$V_{MODE1,2} = 6\text{V}$			0.01	1	μA
PWGD Output Low Voltage	$I_{PWGD} = 1\text{mA}$	●		0.07	0.2	V
PWGD Trip Level	V_{FB1} Falling	●	-13	-10	-8	%
	V_{FB2} Rising	●	8	10	12	%
PWGD Anti-Glitch Delay	V_{PWGD} Rising or Falling	●	2	10	20	μs
PWGD Leakage Current	$V_{PWGD} = 40\text{V}$			0.01	1	μA

Note 1: Stresses beyond those listed under Absolute Maximum Ratings may cause permanent damage to the device. Exposure to any Absolute Maximum Rating condition for extended periods may affect device reliability and lifetime.

Note 2: The LT8210E is guaranteed to meet performance specifications from 0°C to 125°C junction temperature. Specifications over the -40°C to 125°C operating junction temperature range are assured by design, characterization and correlation with statistical process controls. The LT8210I is guaranteed over the full -40°C to 125°C junction temperature range.

Note 3: Do not apply a voltage or current source to these pins. They must be connected to capacitive loads only, otherwise permanent damage may occur.

Note 4: This IC includes overtemperature protection that is intended to protect the device during momentary overload conditions. Junction temperature will exceed the maximum operating junction temperature when overtemperature protection is active. Continuous operation above the specified maximum operating junction temperature range may impair the device reliability.

Note 5: Negative voltages on the SW1, SW2, SNSP1 and SNSN1 pins are limited, in an application, by the body diodes of the external NMOS devices, M_B and M_C , or parallel Schottky diodes when present. These pins are tolerant of these negative voltages in excess of one diode drop below ground, guaranteed by design.

Note 6: Do not force voltage on the V_{C1} , V_{C2} , or SS pin.

TYPICAL PERFORMANCE CHARACTERISTICS

Efficiency vs Load Current
($V_{IN} = 20V$ – Figure 37)

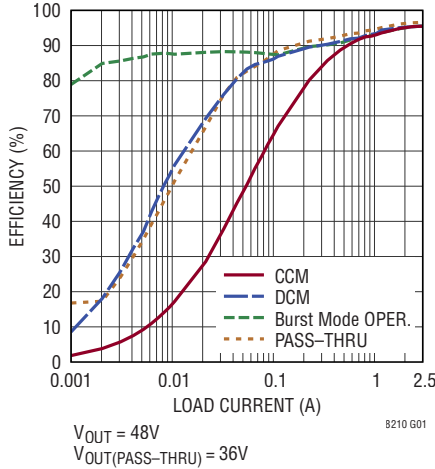

Efficiency vs Load Current
($V_{IN} = 48V$ – Figure 37)

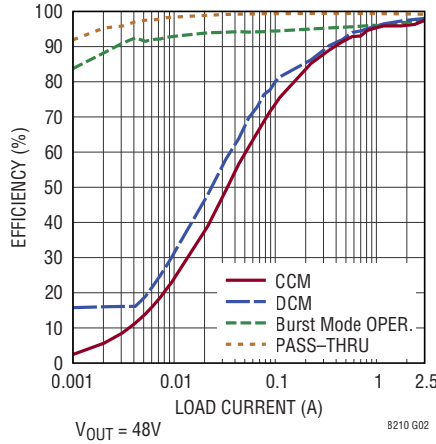

Efficiency vs Load Current
($V_{IN} = 70V$ – Figure 37)

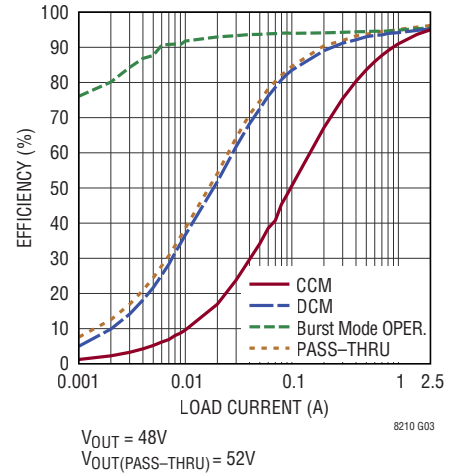

Efficiency and Power Loss vs Input Voltage
(Figure 37)

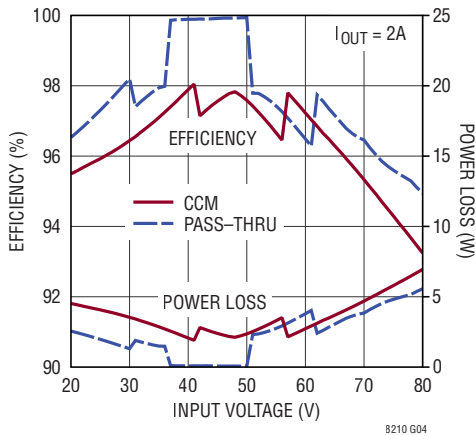

Shutdown Currents vs Voltage

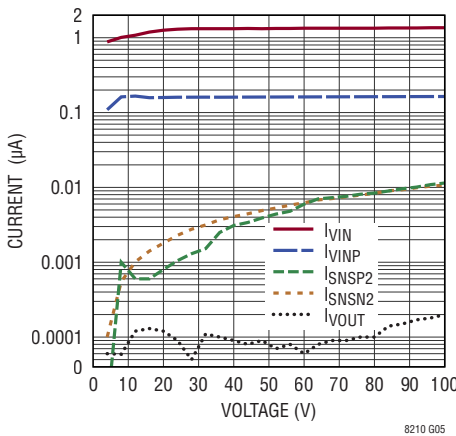

Pass-Thru Non-Switching Currents vs Input Voltage

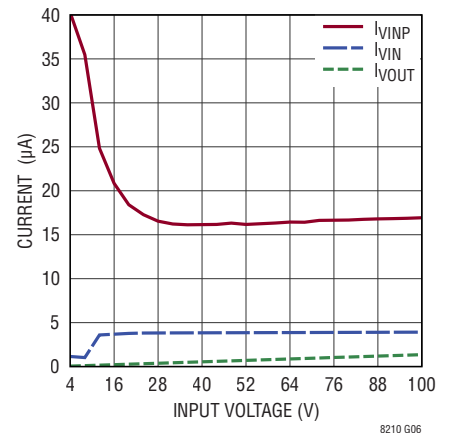

IMON Current Limit vs Input Voltage
(Figure 37)

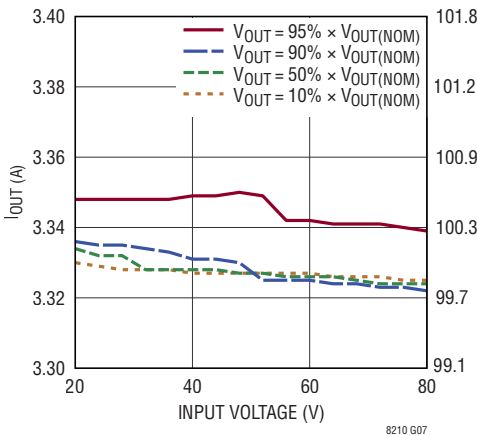

IMON Measurement Accuracy
(Figure 37)

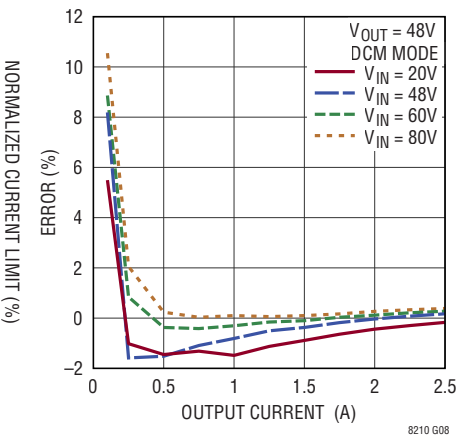

IMON CMRR vs Frequency

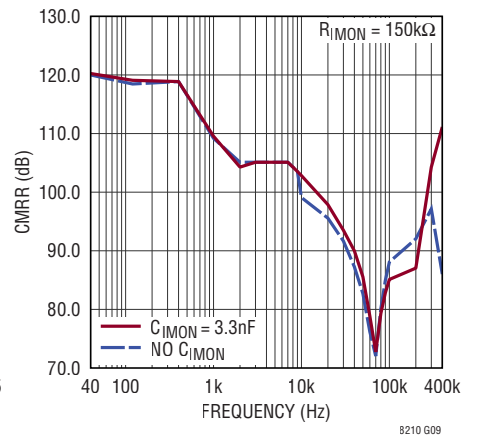

TYPICAL PERFORMANCE CHARACTERISTICS

Maximum Inductor Current:
 $f_{sw} = f_{sw(Optimal)}$
 (Figure 39)

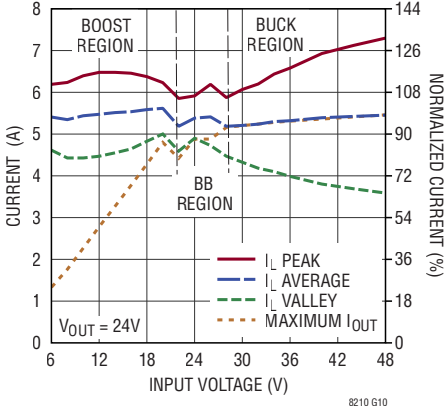

Maximum Inductor Current:
 $f_{sw} = 0.7 \times f_{sw(Optimal)}$
 (Figure 39)

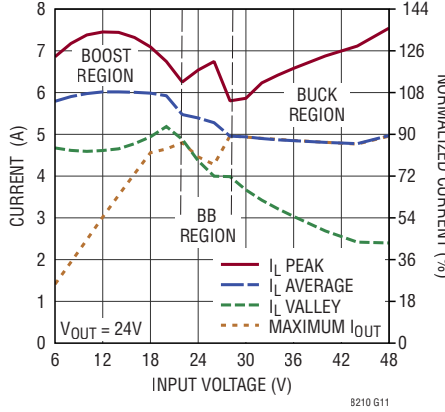

Maximum Inductor Current:
 $f_{sw} = 1.3 \times f_{sw(Optimal)}$
 (Figure 39)

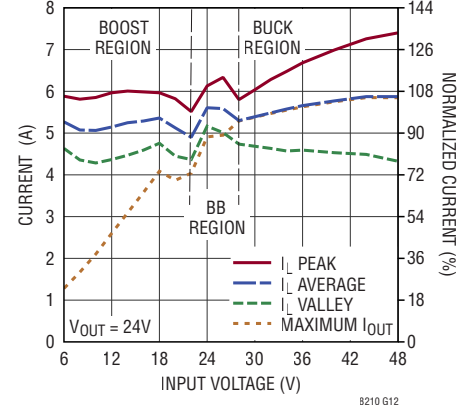

Start-Up (CCM Mode – Figure 36)

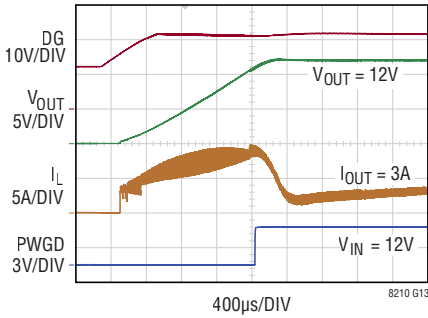

Pre-Biased Output Start-Up (CCM Mode – Figure 36)

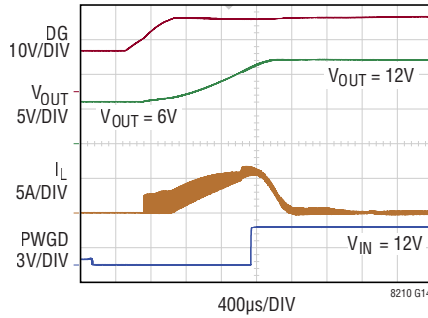

Static Reverse Input Protection (Figure 36)

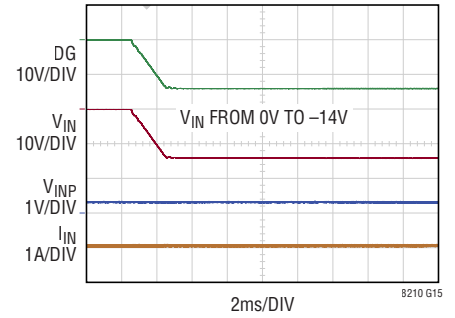

Dynamic Reverse Input Protection (Figure 36)

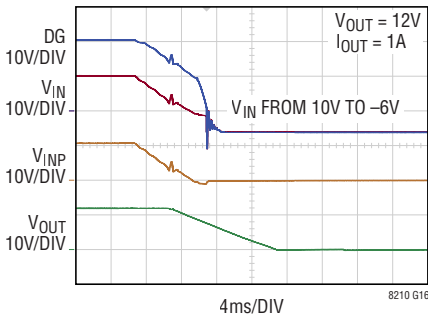

Transition to Current Regulation (Figure 36)

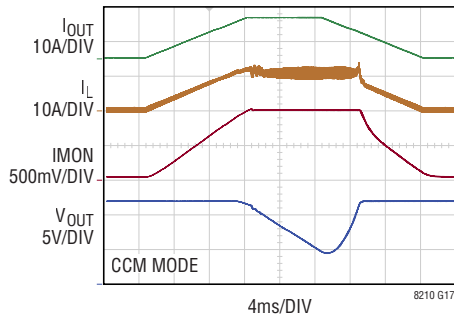

Inductor Current at Light Load (Figure 37)

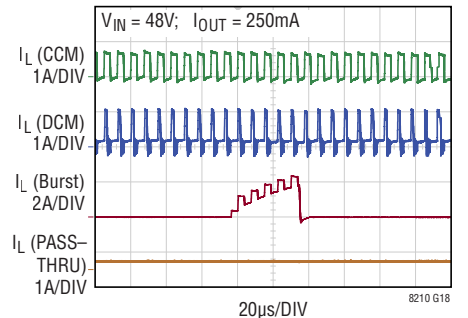

TYPICAL PERFORMANCE CHARACTERISTICS

**Load Step
(Boost Region – Figure 37)**

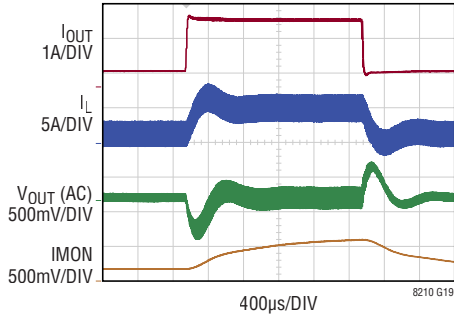

LOAD STEP FROM 500mA TO 2A
 $V_{IN} = 20V$, $V_{OUT} = 48V$, CCM MODE

**Load Step
(Buck-Boost Region – Figure 37)**

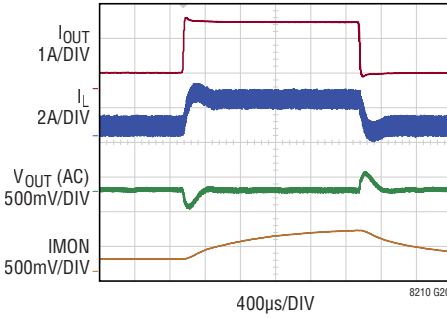

LOAD STEP FROM 500mA TO 2A
 $V_{IN} = 48V$, $V_{OUT} = 48V$, CCM MODE

**Load Step
(Buck Region – Figure 37)**

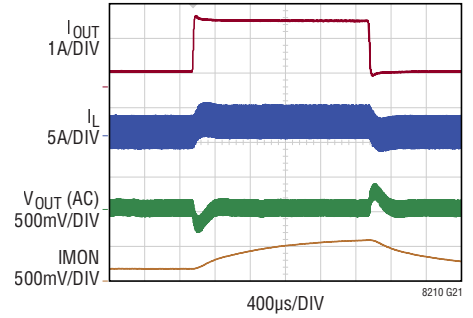

LOAD STEP FROM 500mA TO 2A
 $V_{IN} = 70V$, $V_{OUT} = 48V$, CCM MODE

**Line Step
(Boost Region – Figure 37)**

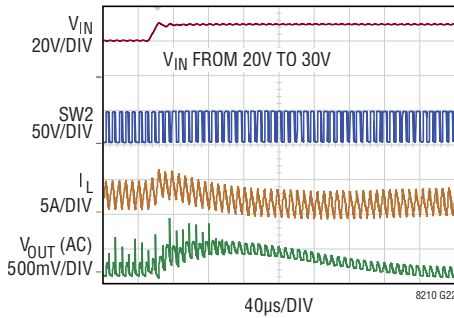

$I_{OUT} = 2A$
CCM MODE

**Line Step
(Buck-Boost Region – Figure 37)**

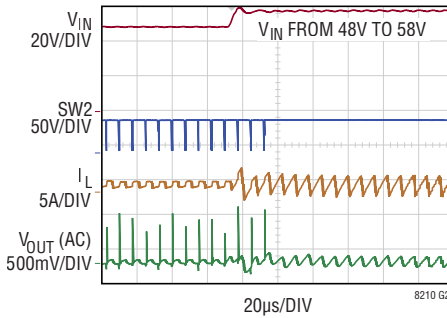

$I_{OUT} = 2A$
CCM MODE

**Line Step
(Buck Region – Figure 37)**

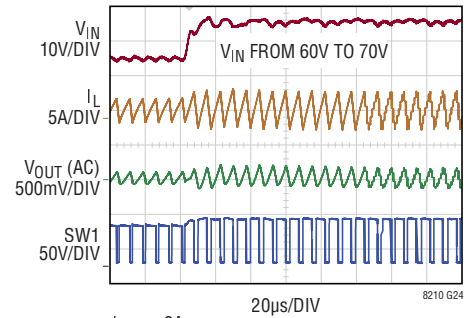

$I_{OUT} = 2A$
CCM MODE

**Input Voltage Sweep
(CCM Mode – Figure 37)**

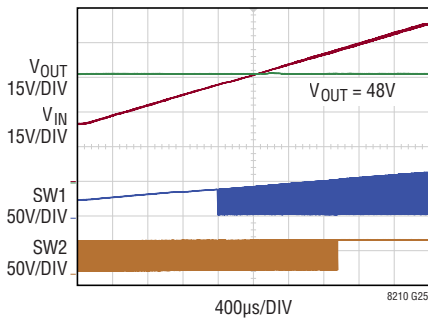

$V_{OUT} = 48V$

**Input Voltage Sweep
(Pass-Thru – Figure 37)**

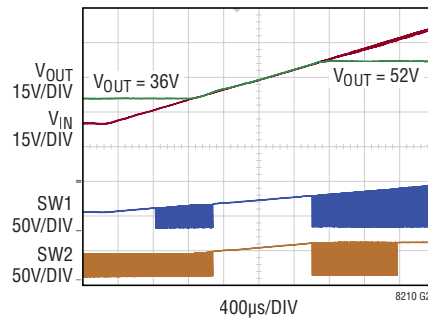

$V_{OUT} = 36V$

$V_{OUT} = 52V$

**High Frequency Switching Region
Transitions (CCM Mode – Figure 37)**

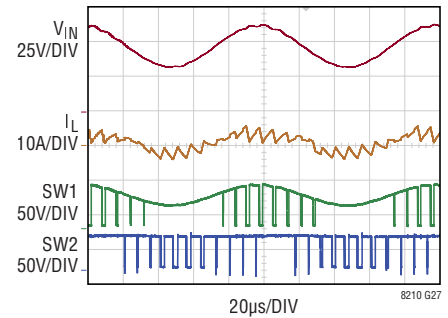

TYPICAL PERFORMANCE CHARACTERISTICS

**Pass-Thru Start-Up:
V_{IN} Below Pass-Thru Window
(Figure 38)**

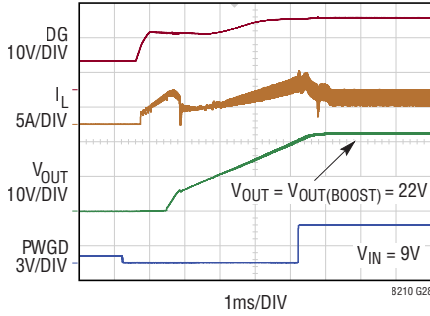

**Pass-Thru Start-Up:
V_{IN} in Pass-Thru Window
(Figure 38)**

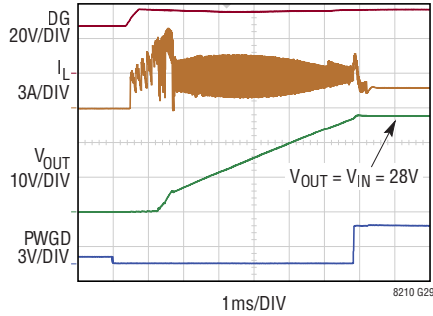

**Pass-Thru Start-Up:
V_{IN} Above Pass-Thru Window
(Figure 38)**

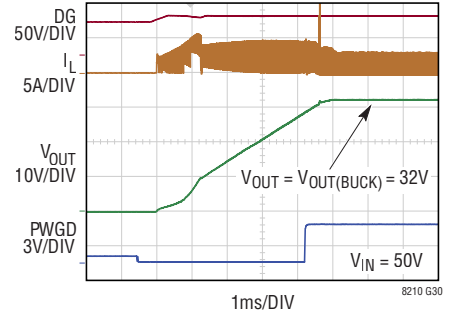

**Pass-Thru Regulation with Noisy
Input Supply (Figure 38)**

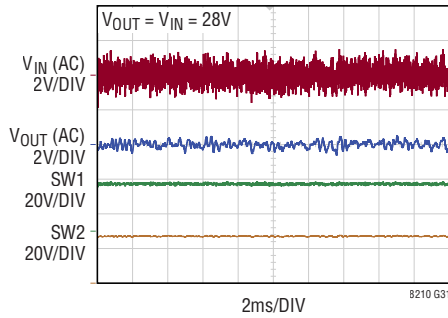

Pass-Thru Line Step (Figure 38)

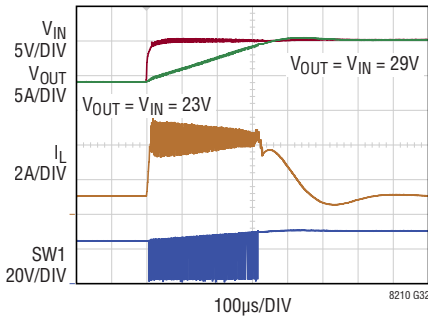

Pass-Thru Load Step (Figure 38)

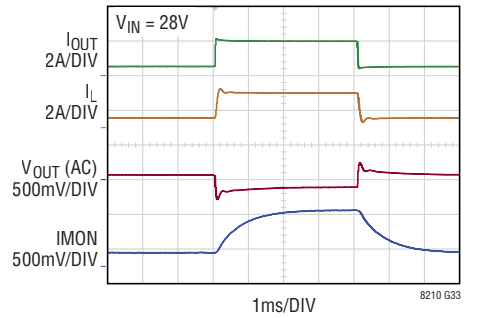

**Pass-Thru Positive Surge
(Figure 38)**

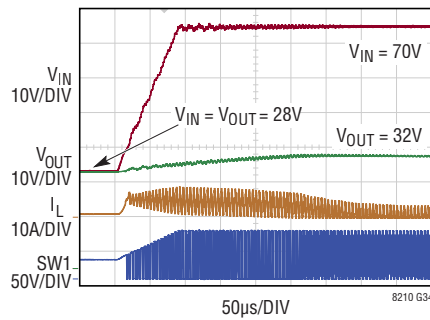

**Pass-Thru Negative Surge
(Figure 38)**

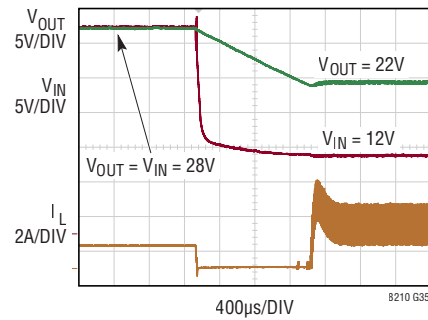

**Pass-Thru Current Limit
(Figure 38)**

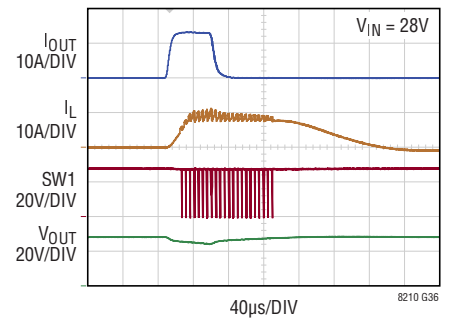

TYPICAL PERFORMANCE CHARACTERISTICS

Pass-Thru IMON Limit (Figure 38)

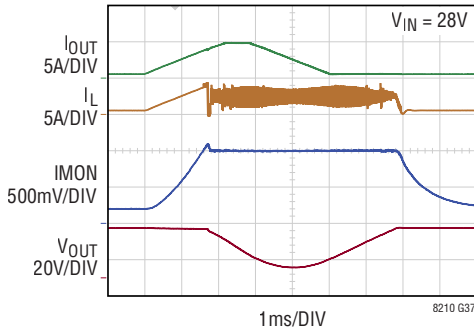

GATEV_{CC} Max Current vs Voltage

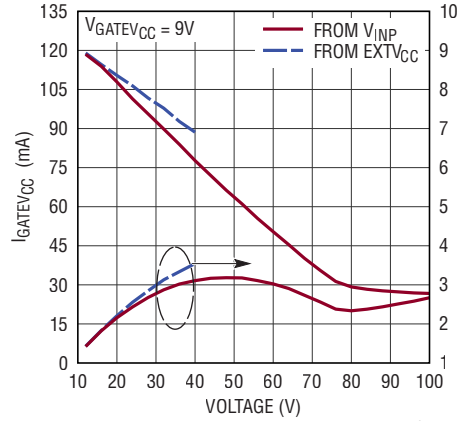

GATEV_{CC} Backdrive Current

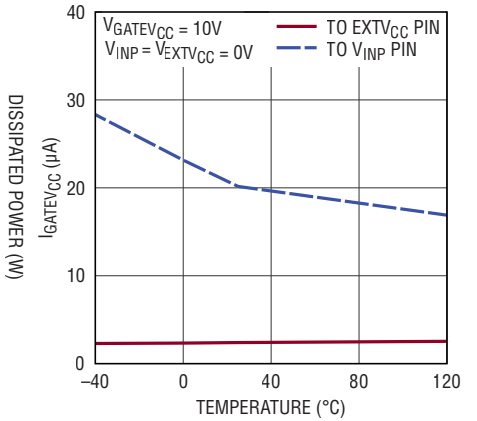

EXTV_{CC}, V_{INP}, Switchover Thresholds for GATEV_{CC} Regulation

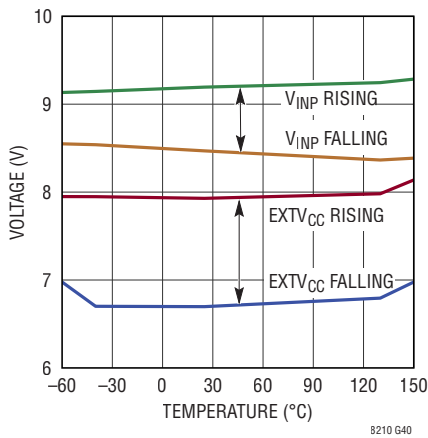

GATEV_{CC} Response to Input Brownout (EXTV_{CC} = 12V)

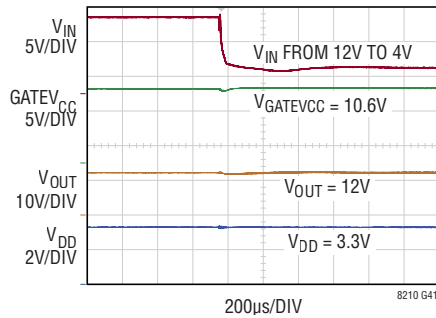

GATEV_{CC} Response to Input Brownout (EXTV_{CC} = 0V)

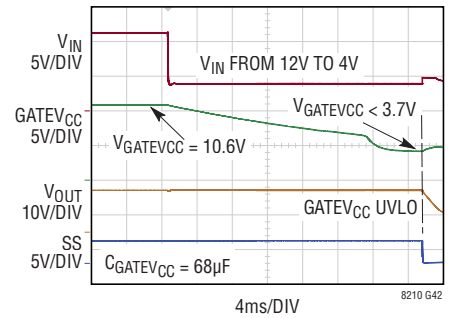

DG Pin Charging Current vs Voltage

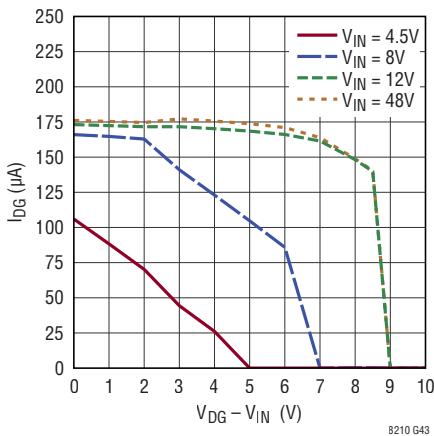

BST1, BST2 Average Charging Current for Non-Switching Channel

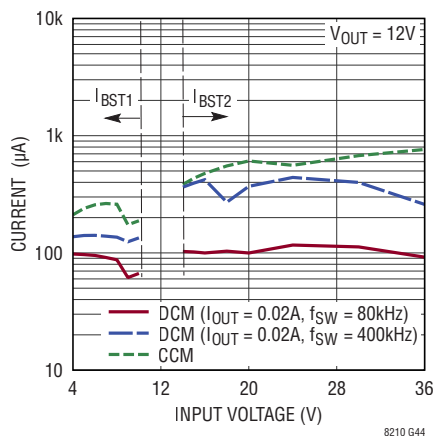

DG, BST1, BST2 Charging in Pass-Thru (Figure 36)

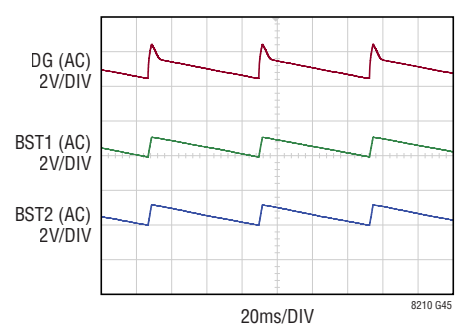

PIN FUNCTIONS (TSSOP/QFN)

EN/UVLO (Pin 1/Pin 37): Precision Enable Input. The LT8210 is enabled when this pin is pulled above 1.45V. A voltage below 1.35V on this pin will cause the LT8210 to reside in a low-power shutdown mode. Tie to V_{IN} for always-on operation. Connect to a resistor divider between V_{IN} and ground to set an undervoltage lockout threshold. EN/UVLO can tolerate negative voltages to $-40V$.

MODE2 (Pin 2/Pin 39): Operating Mode Selection Input #2. Used in conjunction with MODE1 pin to select between continuous conduction switching (CCM), discontinuous switching (DCM), Burst Mode operation, and pass-thru operating modes. Refer to Table 1 in the Operation section for operating mode pin settings.

MODE1 (Pin 3/Pin 40): Operating Mode Selection Input #1. Used in conjunction with MODE2 pin to select between continuous conduction switching (CCM), discontinuous switching (DCM), Burst Mode operation, and pass-thru operating modes. Refer to Table 1 in the Operation section for operating mode pin settings.

SYNC/SPRD (Pin 4/Pin 1): External Clock Synchronization Input. For external sync apply a clock signal between 80kHz and 400kHz to this pin. An internal PLL will synchronize the oscillator to the external clock signal. Connect this pin to the V_{DD} pin to enable spread spectrum operation on the RT set switching frequency, otherwise connect to ground.

PWGD (Pin 5/Pin 2): Power Good Indicator. Open-drain logic output which is pulled to ground when the output voltage is outside $\pm 10\%$ of its programmed value or the IMON pin voltage is greater than 1.20V. This pin can be connected to any voltage rail up to 40V through a pull-up resistor. Using either V_{DD} or $GATEV_{CC}$ for the pull-up supply has the advantage that PWGD will be in the correct state when the part is disabled.

RT (Pin 6/Pin 3): Frequency Set Pin. Place a resistor from this pin to GND to set the switching frequency. The range of frequency adjustment is between 80kHz and 400kHz. Refer to Table 2 in Applications Information.

GND (Exposed Pad Pin 7/Pin 4): Signal Ground. All small-signal components and compensation components should connect to this ground, which in turn connects to the PCB ground at one location away from high currents and switching noise. The exposed pad must be soldered

to the PCB and connect to the GND pin using top layer metal.

V_{DD} (Pin 8/Pin 5): Internally Regulated 3.3V Supply Rail. Bypass this pin to ground with a minimum of 2.2 μ F ceramic capacitor. V_{DD} can be used for tying MODE1, MODE2, and SYNC/SPRD pins logic high.

SS (Pin 9/Pin 6): Soft-Start Input. A capacitor to ground at this pin sets the ramp rate of the inductor current at start-up via internal clamping of the V_{C1} and V_{C2} voltages. The SS pin sources 5 μ A once switching is enabled and is held at ground while switching is disabled.

IMON (Pin 10/Pin 7): Current Monitor Output. The current sourced from this pin is proportional to the voltage difference between the SNSP2 and SNSN2 inputs. Place a resistor from the IMON pin to ground to set the average current limit. The loop will transition from voltage to current regulation when the voltage on IMON exceeds 1.01V.

V_{C1} (Pin 11/Pin 8): Error Amplifier Output and Switching Regulator Compensation Point for CCM, DCM and Burst Mode Operation. In pass-thru mode, this pin is the compensation point for the boost regulator loop. The current mode comparator trip point increases with this control voltage.

V_{C2} (Pin 12/Pin 9): Error Amplifier Output and Switching Regulator Compensation Point for Buck Loop When in Pass-Thru Mode. The current mode comparator trip point increases with this control voltage. If pass-thru mode is not used leave V_{C2} floating.

FB2 (Pin 13/Pin 10): Error Amplifier Feedback Input for Buck Regulation Loop When in Pass-Thru Mode. Receives the feedback voltage for the buck controller from an external resistive divider across the output. If pass-thru mode is not used leave this pin floating.

FB1 (Pin 14/Pin 11): Error Amplifier Feedback Input for CCM, DCM, Burst Operation Modes. Feedback input for boost regulation loop in pass-thru mode. Receives the feedback voltage from an external resistive divider across the output.

V_{OUT} (Pin 16/Pin 13): Output Voltage Sense. This pin must have a Kelvin connection to the drain of switch D.

PIN FUNCTIONS (TSSOP/QFN)

Use a small RC low-pass filter (e.g., 50Ω and 22nF) for improved jitter performance when V_{OUT} ripple is large.

SNSP2, SNSN2 (Pins 19,18/Pins 16,15): Positive (+) and Negative (–) Inputs for the Average Current Sense Monitor. SNSP2, SNSN2 should connect to the positive and negative terminals of a sense resistor placed in series with the input, output or load. A current linearly proportional to difference in voltage between the SNSP2 and SNSN2 pins is sourced from the IMON pin and can be used for current monitoring and limiting with the selection of the R_{IMON} resistor.

TG2 (Pin 20/Pin 18): Top Gate Drive for Boost Regulator. Drives top N-channel MOSFET with a voltage swing equal to $GATEV_{CC}$ superimposed onto the SW2 node voltage. When operating in the buck region or within the pass-thru window TG2 is held roughly at $V_{OUT} + GATEV_{CC}$.

SW2 (Pin 21/Pin 19): Boost Regulator Switch Node. The (–) terminal of the bootstrap capacitor connects here.

BST2 (Pin 22/Pin 20): Boosted Floating Driver Supply for Boost Regulator. The (+) terminal of the bootstrap capacitor connects here. The BST2 pin swings from roughly $GATEV_{CC}$ to $V_{OUT} + GATEV_{CC}$ when the boost regulation loop is switching. When operating in the buck region or the within pass-thru window this pin is held roughly at $V_{OUT} + GATEV_{CC}$.

BG2 (Pin 24/Pin 21): Bottom Gate Drive for Boost Regulator. Drives bottom N-channel MOSFET with a voltage swing between $GATEV_{CC}$ and PGND.

PGND (Pin 25/Pin 22): Driver Power Ground. Connect to C_{IN} , C_{OUT} and sources of MOSFETs, M_C and M_D .

BG1 (Pin 26/Pin 23): Bottom Gate Drive for Buck Regulator. Drives bottom N-channel MOSFET with a voltage swing between $GATEV_{CC}$ and PGND.

GATEV_{CC} (Pin 27/Pin 24): Power Supply for Gate Drivers. Internally regulated to 10.6V. Bypass this pin to ground with a minimum 4.7μF ceramic capacitor.

EXTV_{CC} (Pin 28/Pin 25): External Power Supply Input for the $GATEV_{CC}$ Regulator. $GATEV_{CC}$ will be linearly regulated from EXTV_{CC} if its voltage is higher than 8V and is simultaneously lower than V_{INP} . May be driven with voltages

up to 40V. If this feature is not used, connect this pin to ground through a 100k resistor.

BST1 (Pin 30/Pin 27): Boosted Floating Driver Supply for Buck Regulator. The (+) terminal of the bootstrap capacitor connects here. The BST1 pin swings from roughly $GATEV_{CC}$ to $V_{IN} + GATEV_{CC}$ when the buck regulation loop is switching. When operating in the boost region or within the pass-thru window this pin is held roughly at $V_{IN} + GATEV_{CC}$.

SW1 (Pin 31/Pin 28): Buck Regulator Switch Node. The (–) terminal of the bootstrap capacitor connects here.

TG1 (Pin 32/Pin 29): Top Gate Drive for Buck Regulator. Drives top N-channel MOSFET with a voltage swing equal to $GATEV_{CC}$ superimposed onto the SW1 node voltage. When operating in the boost region or within the pass-thru window TG1 pin is held roughly at $V_{IN} + GATEV_{CC}$ continuously.

SNSP1, SNSN1 (Pins 34, 33/Pin 31,30): Positive (+) and Negative (–) Inputs for the Inductor Current Sense Amplifier. Place an appropriately valued shunt resistor in series with the inductor on the SW1 side and connect to SNSP1 and SNSN1. The SNSP1 – SNSN1 voltage is used for current mode control and reverse current detection.

V_{INP} (Pin 36/Pin 33): Protected Main Input Supply. This pin must connect to the drain terminal of switch A. Use a small RC low-pass filter (e.g., 1Ω and 1μF) for improved jitter performance. When reverse input protection is implemented connect this pin to the drain of the DG MOSFET, otherwise connect to V_{IN} .

DG (Pin 37/Pin 34): Reverse Input Protection Gate Drive Output. When V_{IN} is pulled below –1.2V, this pin is clamped internally to V_{IN} with a low resistance switch forcing an external MOSFET between the V_{IN} and V_{INP} pins into cutoff. In normal operation, this pin is charged to roughly $V_{IN} + GATEV_{CC}$ with an internal charge pump to fully enhance the external MOSFET. DG can tolerate negative voltages down to –40V.

V_{IN} (Pin 38/Pin 35): Input Voltage Pin. This pin is used for powering start-up circuitry and the internal charge pump. V_{IN} can withstand negative voltages down to –40V without damaging the regulator or drawing large currents.

BLOCK DIAGRAM

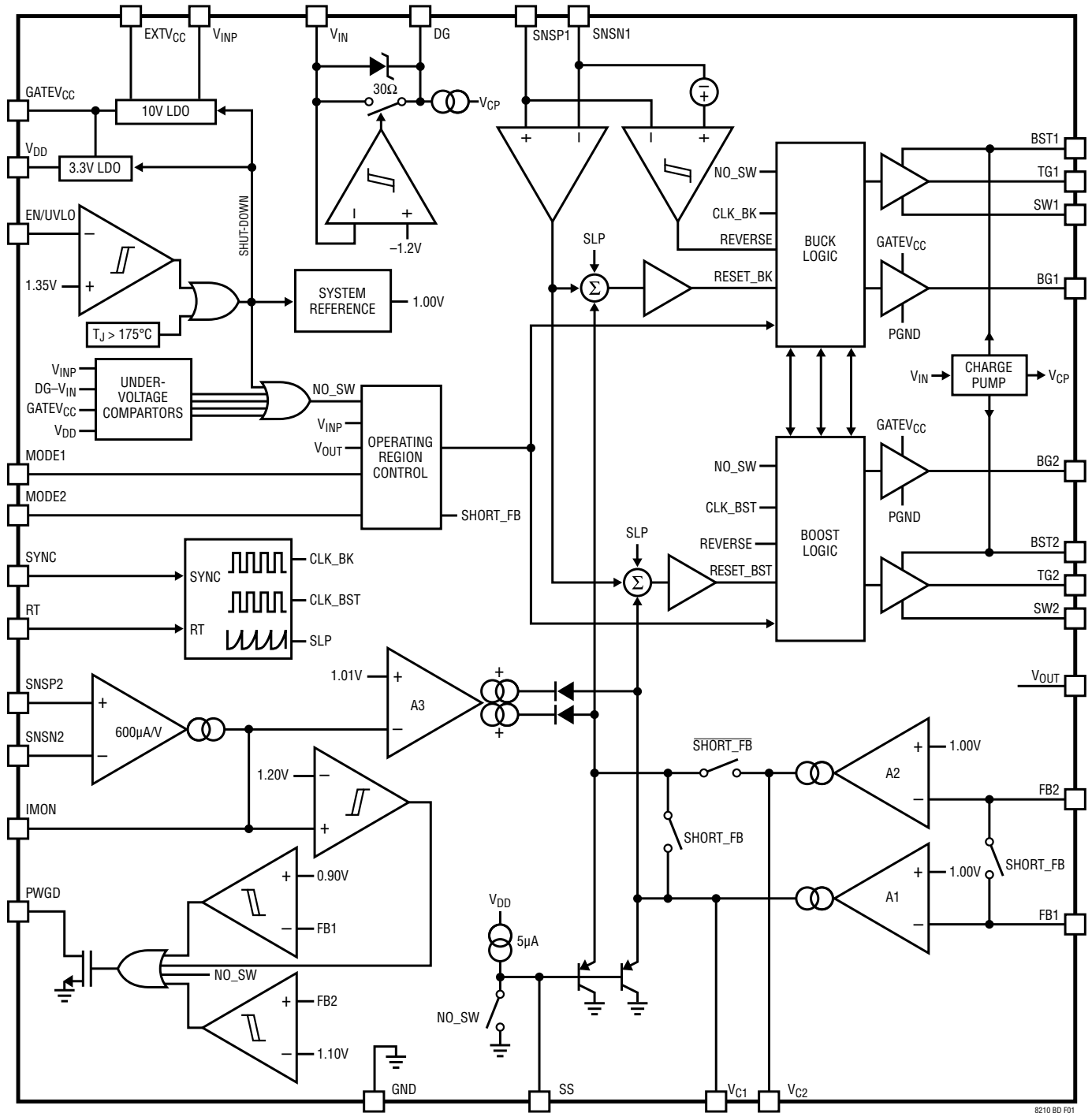

Figure 1. Block Diagram

8210 9D F01

OPERATION

Refer to the Block Diagram (Figure 1) when reading the following sections about the operation of the LT8210.

Overview

The LT8210 has four different operating modes that can be selected by setting the MODE1 and MODE2 pins either high ($>1.17V$) or low ($<0.80V$). The threshold voltage of the MODE1 and MODE2 pins allow them to be driven with 1.8V, 2.5V, 3.3V or 5V logic levels for dynamic control. If the operating mode is fixed, tie MODE1 and MODE 2 pins to V_{DD} to set high or to ground to set low.

Table 1 shows the operating mode corresponding to the various MODE1, MODE2 pin combinations. In continuous conduction mode (CCM), discontinuous conduction mode (DCM) and Burst Mode operation, the LT8210 operates as a conventional buck-boost controller with the output regulated to a voltage set by the resistive divider between V_{OUT} , FB1 and GND. In pass-thru mode the output voltage is regulated to a window defined by a minimum and maximum value programmed using the FB1 and FB2 resistor dividers, respectively.

Table 1. LT8210 Operating Modes

MODE2	MODE1	OPERATING MODE
LOW	LOW	Continuous Conduction Mode (CCM)
LOW	HIGH	Discontinuous Conduction Mode (DCM)
HIGH	LOW	Burst Mode Operation
HIGH	HIGH	Pass-Thru Mode

Continuous Conduction Mode (CCM)

Continuous conduction mode allows the inductor current to reverse directions once the voltage at the SS pin has exceeded 2.5V (typical). This precaution is intended to prevent large negative inductor currents during start-up when the output is pre-biased to a non-zero voltage. Once CCM mode is enabled, a negative current sense limit with a magnitude roughly equal to the positive current sense limit sets the lower bound on the inductor current. This ensures that the inductor current is limited on a cycle-by-cycle basis whether the direction of current flow is forward or reverse. The maximum recommended switching frequency for CCM operation is 350kHz.

Discontinuous Conduction Mode (DCM)

Discontinuous conduction mode prevents the inductor current from reversing direction at low output currents. DCM operation improves light load efficiency and also blocks significant current draw from the output back into the input. Reverse current is detected when the SNSP1 – SNSN1 voltage drops below its reverse current threshold (typically 3mV) while either switch B or D is conducting. When operating in either the buck or buck-boost regions, the on-time of switch B is ended upon reverse current detection. Similarly, in the boost and buck-boost regions the on-time of switch D is ended when reverse inductor current is detected. At very light loads the LT8210 may be forced to skip multiple switching pulses to maintain output voltage regulation in DCM. This situation arises when the average inductor current exceeds the load current even while switching at duty cycle limits. If pulse-skipping behavior is undesired it may be possible to resolve by increasing the size of the inductor or reducing the switching frequency. Otherwise, the LT8210 can be operated in CCM for full switching frequency operation.

Burst Mode Operation

Burst Mode operation sets a V_{C1} level, with approximately 25mV of hysteresis, below which switching activity is inhibited and above which switching activity is re-enabled. A typical example is when, at light output currents, V_{OUT} rises and forces the V_{C1} pin below the threshold that temporarily inhibits switching. After V_{OUT} drops slightly and V_{C1} rises ~25mV, the switching is resumed. Burst Mode operation can increase efficiency at light load currents by eliminating unnecessary switching activity and related power losses. The LT8210 supply current drops to 65 μ A (typical) in the non-switching state to maximize light load efficiency. Burst Mode operation inhibits reverse inductor current in the same manner as DCM mode.

Pass-Thru Mode

In pass-thru mode, the respective output voltages for the buck and boost loops, $V_{OUT(BUCK)}$ and $V_{OUT(BOOST)}$, are programmed independently. The output voltage is regulated to a window defined by a minimum at $V_{OUT(BOOST)}$ and a maximum at $V_{OUT(BUCK)}$. $V_{OUT(BUCK)}$ is set with a

OPERATION

resistive divider between V_{OUT} , FB2 and GND. The FB2 voltage is compared with the 1.00V system reference and the resulting output of amplifier A2, V_{C2} , controls the inductor current when the buck loop is active. Similarly, $V_{OUT(BOOST)}$ is set with a resistive divider between V_{OUT} , FB1 and GND. The voltage on FB1 is compared with the 1.00V system reference using amplifier A1 and resulting output on the V_{C1} pin controls the inductor current when the boost loop is active. The boost loop will control the inductor current and regulate the output to $V_{OUT(BOOST)}$ when V_{INP} is less than or equal to $V_{OUT(BOOST)}$. Likewise, when the input voltage is greater than or equal to $V_{OUT(BUCK)}$ the buck loop will control the inductor current and regulate the output to $V_{OUT(BUCK)}$. Near the boundaries of the pass-thru window interleaved buck-boost switching is used to avoid pulse-skipping. When the input voltage lies between $V_{OUT(BOOST)}$ and $V_{OUT(BUCK)}$, both top switches will turn on continuously once V_{OUT} has settled close in value to V_{INP} . In this state, V_{OUT} follows V_{INP} and the LT8210 enters a power saving mode with typical quiescent currents on the V_{IN} and V_{INP} pins of $4\mu A$, $18\mu A$, respectively. Switching will recommence if the SNSP1 – SNSN1 voltage exceeds 63mV (typical) to limit the maximum inductor current. Similarly, if a current regulation loop is implemented, switching will resume when the IMON pin voltage approaches 1.01V. With no switching losses and extremely low quiescent current, it is possible to achieve efficiencies greater than 99.9% in the pass-thru region.

Power Switch Control (CCM, DCM, Burst Mode Operation)

The LT8210 is a current mode buck-boost controller that regulates the output voltage above, equal to or below the input voltage. The LTC® proprietary topology and control architecture employs a current-sensing resistor in series with the inductor that is used for current mode control and provides clean transitions between buck, buck-boost, and boost switching regions. When the LT8210 is configured

for CCM, DCM or Burst Mode operation, the inductor current is controlled by the voltage on the V_{C1} pin. If a current regulation loop is implemented, then the V_{C1} voltage will be controlled by either the sensed feedback voltage (FB1) or the sensed current when the IMON pin voltage approaches 1.01V. Figure 2 shows a simplified diagram of how the power switches A, B, C, D are connected to the inductor L, the current sense resistor R_{SENSE} , the power input V_{INP} , power output V_{OUT} , and ground. Switches A and B form the synchronous buck power stage, while switches C and D form the synchronous boost power stage. The current sense resistor R_{SENSE} is connected to the SNSP1 and SNSN1 pins and provides the inductor current information for both current mode control and reverse current detection. Figure 3 shows the switching region as a function of the V_{INP}/V_{OUT} ratio. The power switches are controlled to smoothly transition between switching regions with hysteresis added to prevent chattering between modes.

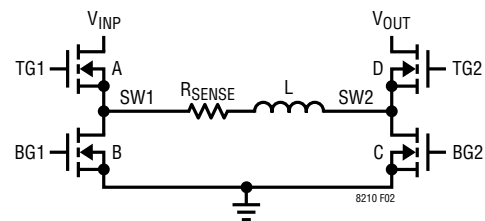

Figure 2. Simplified Diagram of the Power Switches

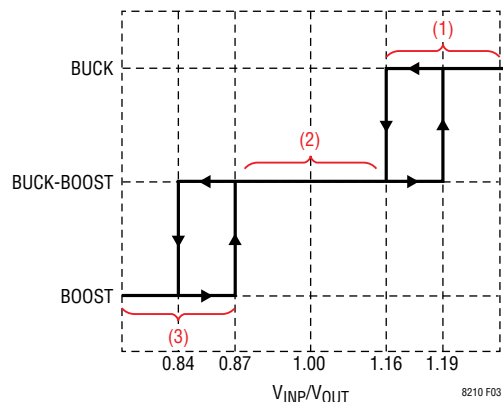

Figure 3. Switching Region vs V_{INP}/V_{OUT} Ratio

OPERATION

Power Switch Control: Buck Region ($V_{INP} > 1.19 \cdot V_{OUT}$)

When V_{INP} is greater than V_{OUT} by 19% (typical) or more, the part will run in the buck region. In the buck region, switch D is always on while switch C is always off. Switches A and B will toggle on and off acting as a synchronous buck regulator. If the inductor current should drop below the reverse current sense threshold in DCM or negative current sense threshold in CCM, switch B will be turned off for the remainder of the switching cycle, preventing the inductor current from falling any further.

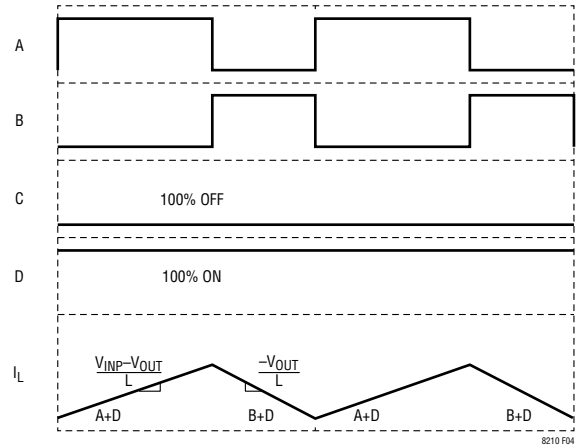

Figure 4. Buck Region Switching Waveforms

Power Switch Control: Boost Region ($V_{INP} < 0.84 \cdot V_{OUT}$)

When V_{INP} is less than V_{OUT} by more than 16%, the part will run in the boost region. In this region, switch A is always on while switch B is always off. Switches C and D will toggle on and off acting as a synchronous boost regulator. The on-time of switch D will be terminated if the inductor current drops below the reverse current sense threshold in DCM or the negative current sense threshold in CCM.

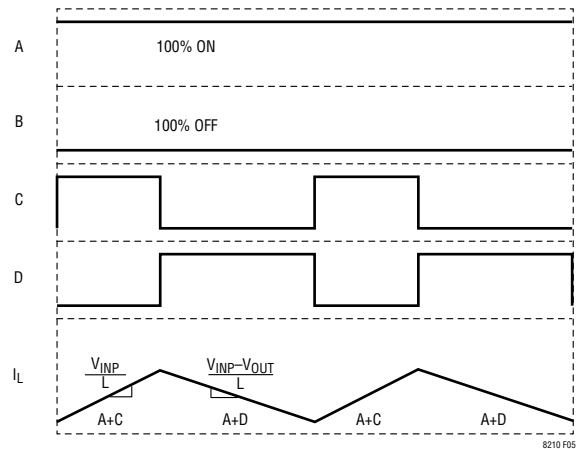

Figure 5. Boost Region Switching Waveforms

Power Switch Control: Buck-Boost Region ($0.84 \cdot V_{OUT} < V_{INP} < 1.19 \cdot V_{OUT}$)

When V_{INP} is within -16% to $+19\%$ of V_{OUT} , the part operates in the buck-boost region where all four power switches (A, B, C, D) are active. The buck-boost region can be thought of as an over-lapping of the buck and boost control regions where the buck and boost regulation loops both control the inductor current. The sharing of inductor current control between the buck and boost loops avoids abrupt handoffs within the buck-boost region that can perturb the inductor current and output voltage. The on-time of switches B and D will be terminated if the inductor current drops below the reverse current sense threshold in DCM or the negative current sense threshold in CCM.

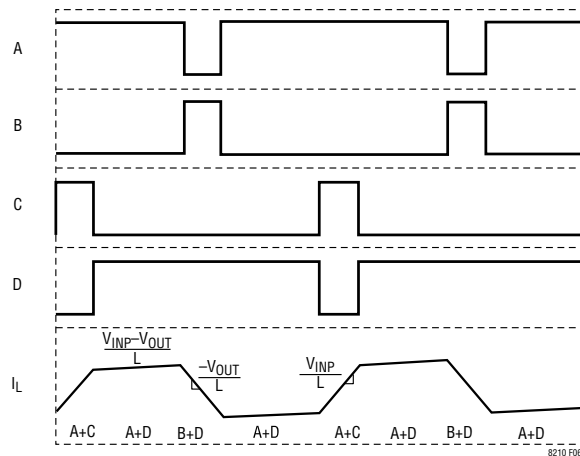

Figure 6. Buck-Boost Region Switching Waveforms

OPERATION

Power Switch Control (Pass-Thru Mode)

In pass-thru mode, the buck and boost regulation loops function independently after start-up. Separate error amps are used to create a pass-thru window by setting the programmed output voltage for the buck regulation, $V_{OUT(BUCK)}$, higher than the programmed output voltage for boost regulation, $V_{OUT(BOOST)}$. Figure 7 shows the different switching regions in pass-thru mode versus input voltage.

When $V_{INP} \gg V_{OUT(BUCK)}$, the LT8210 will operate in the buck region. In this region switch D is always on while switch C is always off, switches A and B will toggle on and off, acting as a synchronous buck regulator, while maintaining the output at $V_{OUT(BUCK)}$. When V_{IN} is between 93% to 119% of $V_{OUT(BUCK)}$, switch D will also begin switching to avoid the need for pulse skipping. Switch C will alternate with D in this region. When $V_{INP} \ll V_{OUT(BOOST)}$ switch A is always on while switch B is always off, switches C and D toggle on and off acting as a synchronous boost regulator to maintain the output at $V_{OUT(BOOST)}$. When V_{IN} is between 84% to 107% of $V_{OUT(BOOST)}$, switch A will also begin switching, alternating with switch B. When V_{INP} is between $V_{OUT(BOOST)}$ and $V_{OUT(BUCK)}$, the output voltage will track the input. Once V_{OUT} has settled close to V_{INP} , the LT8210 will enter a low power state where switches A and D are turned on continuously and switches B and C are off. In pass-thru mode reverse-current is handled

in a similar manner to DCM while switching. In the non-switching state reverse-current is detected through direct comparison of the V_{INP} and V_{OUT} voltages. If the voltage on V_{OUT} exceeds that on V_{INP} by a set percentage, switches A, C and D are turned off and the output is only reconnected after it has discharged to be nearly equal with V_{INP} . If a positive line transient occurs while in the non-switching pass-thru window causing V_{INP} to exceed V_{OUT} by a set percentage, switching will recommence to prevent large amplitude ringing in the inductor current. The output will be driven to the input voltage in a manner similar to soft-start and switches A and D will turn on continuously again after V_{OUT} settles close to V_{INP} .

Transitioning Between Operating Modes

It is possible to dynamically transition between pass-thru mode and CCM, DCM, or Burst Mode operation by toggling the MODE1 and/or MODE2 pins. While in CCM, DCM, or Burst Mode operation, the FB1 and FB2 pins are internally connected with a low resistance switch. In pass-thru mode, this switch is disabled after start-up allowing the feedback pins to move independently. When exiting pass-thru mode the FB1 and FB2 pins will once again be connected. By scaling the relative magnitudes of R_{2B} , R_{2A} , R_{1B} and R_{1A} resistors, the fixed output voltage in CCM, DCM, or Burst Mode operation can be placed at any desired voltage between the $V_{OUT(BUCK)}$ and $V_{OUT(BOOST)}$ voltages that define the top and bottom of the pass-thru window (Figure 8). Cycling into and out of pass-thru mode allows the user to exchange wider output voltage tolerance for no switching losses or noise as the conditions in the application change.

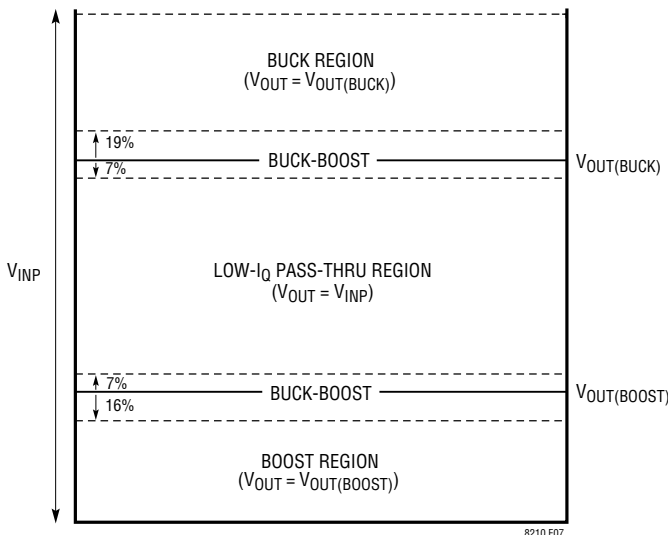

Figure 7. Pass-Thru Regions vs V_{INP}

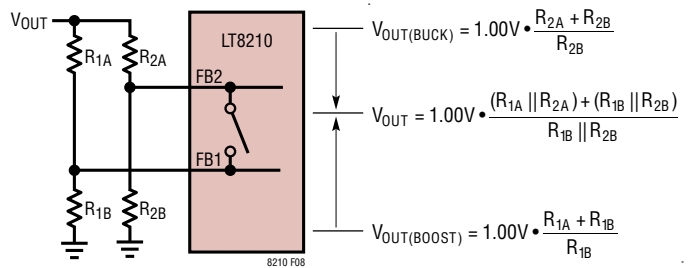

Figure 8. Output Voltage when Exiting Pass-Thru Mode

OPERATION

Enable and Start-Up

The LT8210 start-up sequence is shown in Figure 9.

When the voltage on the EN/UVLO pin is less than the turn on threshold (typically 1.45V), the LT8210 resides in a low power shutdown mode where the internal GATEV_{CC} and V_{DD} regulators are disabled and the quiescent current of the V_{IN} and V_{INP} pins drops to approximately 1μA. When the EN/UVLO voltage is pulled above 1.45V, the GATEV_{CC} and V_{DD} regulators are activated and are only disabled if the die temperature exceeds the internal thermal shutdown limit of 175°C. After both the GATEV_{CC} and V_{DD} voltages have risen beyond their undervoltage lockout thresholds (typical values of 3.95V and 2.94V, respectively), the internal charge pump will begin sourcing current from the DG pin. When the DG to V_{IN} voltage has charged to greater than 2.8V (typical), the switching control logic is initialized. A brief delay allows analog circuitry to settle prior to start-up after which a 5μA current is sourced from the SS pin initiating the soft-start ramp and the LT8210 will begin switching. Connect EN/UVLO to V_{IN} for always-on

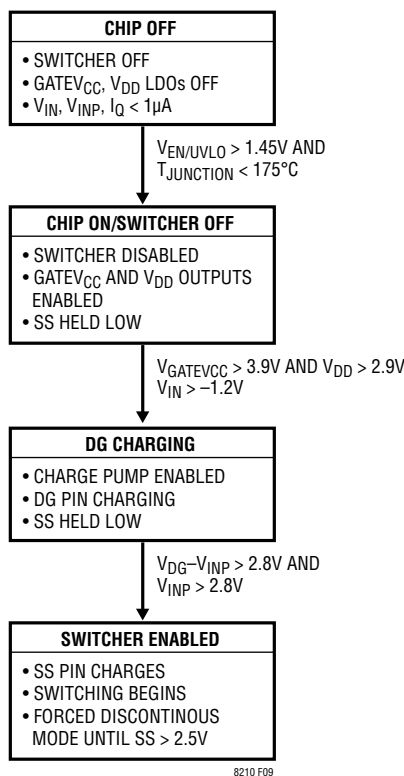

Figure 9. Start-Up Sequence

operation or to a resistive divider between V_{IN} and ground to program an undervoltage lockout (UVLO) threshold.

EXTV_{CC}/GATEV_{CC}/V_{DD} Power Supplies

Power for the TG1, BG1, TG2, BG2 MOSFET drivers and the internal V_{DD} regulator are derived from GATEV_{CC}. The GATEV_{CC} supply is linearly regulated to 10.6V (typical) from PMOS low dropout regulators powered by either the V_{INP} or EXTV_{CC} pins. When the voltage on EXTV_{CC} exceeds 8V (typical) and is simultaneously lower than V_{INP}, GATEV_{CC} will be regulated from EXTV_{CC}. The internal comparison between EXTV_{CC} and V_{INP} causes the LT8210 to regulate GATEV_{CC} from the lower of these two voltages, minimizing power dissipation. This comparison criteria is dropped when V_{INP} is less than 8.5V (typical). This allows the EXTV_{CC} pin to maintain GATEV_{CC} above 10V during an input brownout condition. If EXTV_{CC} is not used connect to ground through a 100k resistor. The GATEV_{CC} regulator has built-in backdrive protection should the input momentarily drop below the GATEV_{CC} voltage to avoid discharging the bypass capacitor and resetting the part. The LT8210 will maintain normal operation as long as both the V_{INP} and GATEV_{CC} voltages remain above their undervoltage lockout (UVLO) thresholds, typically 2.7V and 3.7V, respectively. The GATEV_{CC} regulator is current limited in order to prevent excessive power dissipation and possible damage. This current limit decreases linearly at higher voltages, effectively clamping the internal power dissipation at 3W (typical). Figure 10 shows the typical GATEV_{CC} current limit as a function of voltage on the V_{INP} and EXTV_{CC} pins. Lower current limit at higher voltages

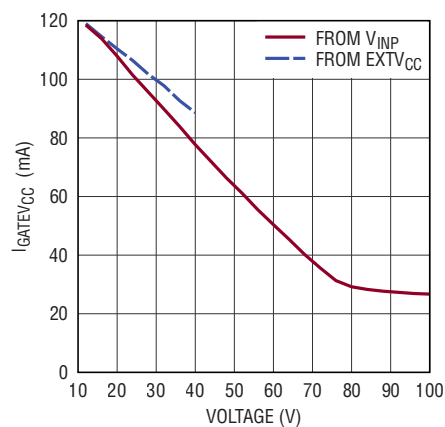

Figure 10. GATEV_{CC} Current Limit vs V_{INP}, EXTV_{CC}

OPERATION

restricts the amount of gate drive current that the LT8210 can provide and should be considered when selecting the power MOSFETs and the switching frequency. The voltage at the V_{DD} pin is linearly regulated to 3.3V from $GATEV_{CC}$ and powers the low voltage circuitry within the LT8210. It should be bypassed with a minimum 2.2 μ F X5R/X7R capacitor to ground placed close to the pin. V_{DD} is a good choice for tying logic pins high (e.g., MODE1, MODE2, SYNC/SPRD) and as the pull-up supply for the PWGD pin. The V_{DD} regulator has a 10mA current limit. For powering external loads other than those described from the V_{DD} rail please contact the factory for support.

Reverse Input Protection

The LT8210 includes optional reverse input protection down to $-40V$. To implement this feature, a power N-channel MOSFET should be placed with its source connected to V_{IN} , its drain connected to V_{INP} and its gate connected to the DG pin. When the voltage at V_{IN} drops below $-1.2V$ (typical) the DG pin is clamped to the V_{IN} pin through an internal 30Ω (typical) switch. With its gate and source shorted, the external MOSFET is forced into cutoff, disconnecting V_{INP} and downstream circuitry from the input and preventing damage. The V_{IN} , DG, and EN/UVLO pins are all able to withstand voltages down to $-40V$ without damage or excessive current flow. If polarized capacitors are used for input filtering, they should be placed on the V_{INP} side of the DG MOSFET. During normal operation, the DG $- V_{IN}$ voltage is charged to approximately 8.5V via the internal charge pump in order to fully enhance the MOSFET. Switching will be disabled if the DG $- V_{IN}$ voltage drops below 2.1V (typical) and re-enabled when it exceeds 2.8V (typical). The DG undervoltage lockout is

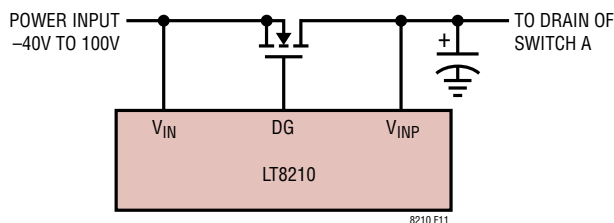

Figure 11. Implementing Reverse Input Protection

intended to prevent excessive power dissipation in the DG MOSFET when it is not enhanced and current conducts through its body diode. The internal charge pump is able to source up to 180 μ A from the DG pin for fast charging and minimal delay at start-up. If reverse input protection is not needed, V_{INP} should be connected to V_{IN} directly or through a small RC filter (e.g., 1 Ω , 1 μ F) and a 1nF, 25V ceramic capacitor should be placed between the DG and V_{IN} pins.

Current Monitoring and Regulation

The LT8210 is equipped with a precision current sense amplifier that can be used for monitoring and regulating average current. The current measurement accuracy is comparable to stand-alone current sense amplifiers making it suitable for applications that require precision monitoring. The input common mode range of the amplifier spans 0V to 100V allowing monitoring and regulation of output, input, or ground current (Figure 12, Figure 13 and Figure 14, respectively). A current linearly proportional to the voltage between the SNSP2, SNSN2 pins is sourced from the IMON pin and into a resistor connected to ground, generating an amplified version of the sense resistor voltage. As the voltage on the IMON pin approaches 1.00V, amplifier A3 will begin to sink current from V_{C1} (and also V_{C2} in pass-thru mode) until the part transitions from voltage regulation to current regulation. The closed loop IMON voltage is regulated to within 3% of 1.01V for tight current limiting. A current regulation loop may be implemented in CCM, DCM, Burst Mode operation, or pass-thru mode. The IMON amplifier operates continuously while the part is enabled including the non-switching states in DCM, Burst Mode operation, and pass-thru mode. If the IMON voltage approaches 1.01V while in the non-switching pass-thru state, switching will be re-initiated to limit average current. Do not place R_{SENSE2} on either the SW1 or SW2 nodes. If the current regulation/monitoring is not needed, connect IMON to V_{DD} and the SNSP2, SNSN2 pins to ground to disable internal circuitry and reduce quiescent current.

OPERATION

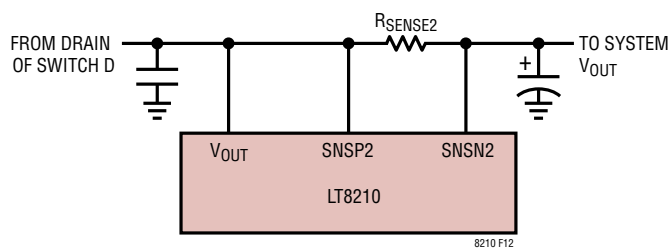

Figure 12. Output Current Sense

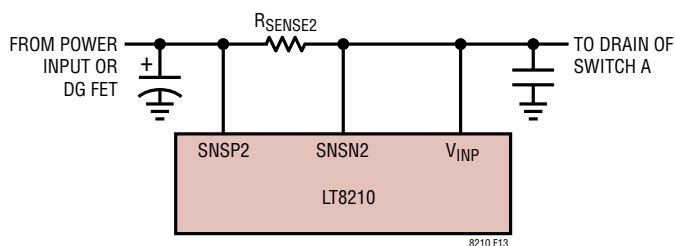

Figure 13. Input Current Sense

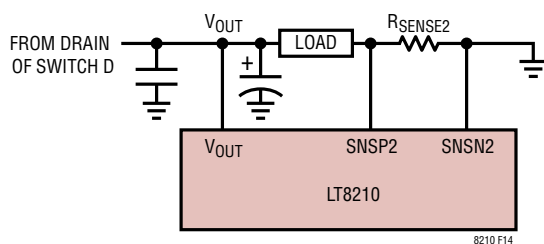

Figure 14. Ground Current Sense

Buck Foldback

The LT8210 actively prevents inductor current runaway while the buck loop is switching. The inductor current can run away when its rising slope exceeds the falling slope to such a degree that the current continues to increase each period even while switching at the minimum SW1 duty cycle. A buck regulator is most susceptible to runaway when the output voltage is near ground causing the inductor current falling slope to be flat. This situation is exacerbated by high input voltage and high switching frequency. To prevent runaway, the LT8210 may skip switch A pulses while V_{OUT} is less than 10% of V_{INP} and the FB1 voltage is lower than 900mV. At the start of the switch A on-time, the sensed inductor current must be below an internally set pulse-skipping threshold otherwise the next pulse on switch A will be skipped. If the inductor current exceeds the pulse-skipping threshold on the next switch

A turn-on, the following three pulses will be skipped, and so on. The foldback circuit increases the number of skipped pulses with each successive switch A pulse where this threshold is exceeded, otherwise the skip count is reset. The maximum foldback of the switching frequency is $1/32 \times f_{SW}$. In addition to preventing inductor runaway, the LT8210 foldback scheme significantly reduces switch A power dissipation in a short circuit condition. When the output is shorted to ground, the power dissipation in switch A is dominated by transitional losses as it turns on and off. Reducing the number of switch A pulses over a given period reduces the dissipated power proportionally. The boost loop is naturally protected from inductor current runaway in the LT8210 as it can only occur when $V_{INP} \sim V_{OUT}$, which is within the buck-boost region. While the buck loop is simultaneously controlling the inductor current each cycle it is not possible for the boost channel to run away.

Bootstrap Capacitor Voltage

During normal operation the BST1 and BST2 capacitors are charged from the $GATEV_{CC}$ supply through diodes D_{BST1} and D_{BST2} while switches B and C are turned on, respectively. Depending on the switching region, switch B and/or C may be off continuously, preventing conventional charging. The LT8210 utilizes an internal charge pump to maintain the bootstrap capacitor voltage of the non-switching channel(s) and avoid forced top gate refresh pulses. While the bootstrap capacitor voltage is above $0.75 \cdot GATEV_{CC}$, a charging current of 50 μ A (typical) is sourced from the BST pin of the non-switching channel. If this voltage drops below $0.75 \cdot GATEV_{CC}$, the average charging current is increased to roughly 200 μ A. Finally, if the bootstrap capacitor voltage should fall below roughly 2V, a minimum on-time bottom gate pulse will be forced to maintain a minimum bootstrap capacitor voltage. An internal clamp across each boost capacitor prevents overcharging. In the non-switching pass-thru state, the internal charge pump is enabled to recharge the BST1 and BST2 capacitors whenever the voltage across either drops below $0.75 \cdot GATEV_{CC}$ and then disabled when it exceeds $0.9 \cdot GATEV_{CC}$.

OPERATION

PWGD Pin

The PWGD pin is an open drain logic output which goes high when the output voltage and IMON pin voltage are within preset limits after switching is enabled. The internal PWGD pull-down is released when V_{OUT} is within $\pm 10\%$ of its programmed value. In CCM, DCM, and Burst Mode operation, this occurs when the FB1 voltage is within $\pm 10\%$ of the 1.00V system reference. In pass-thru mode, PWGD will go high when $V_{FB1} > 0.90V$ and $V_{FB2} < 1.10V$, indicating that the output voltage is within $\pm 10\%$ of the programmed output pass-thru window. PWGD will be pulled low if the voltage on the IMON pin exceeds 1.20V, indicating that the average current exceeds its programmed limit by 20% or more. The LT8210 includes a

built-in self-test to confirm the system reference circuitry is functioning properly. This reference voltage is used for voltage regulation, current regulation, clock generation, and fault detection. If the system reference is outside of preset tolerances switching is disabled and the PWGD pin pulled low. Switching will also be disabled and the PWGD pin pulled low if the V_{INP} , $GATEV_{CC}$, V_{DD} , or DG pin voltage fall below their respective under voltage lockout thresholds. The PWGD pin pull-up resistor can be connected to any external rail up to 40V. Using either V_{DD} or $GATEV_{CC}$ as the pull-up supply has the added advantage that PWGD will be in the correct state when the LT8210 is disabled. Figure 15 shows the conditions which determine the state of the PWGD pin.

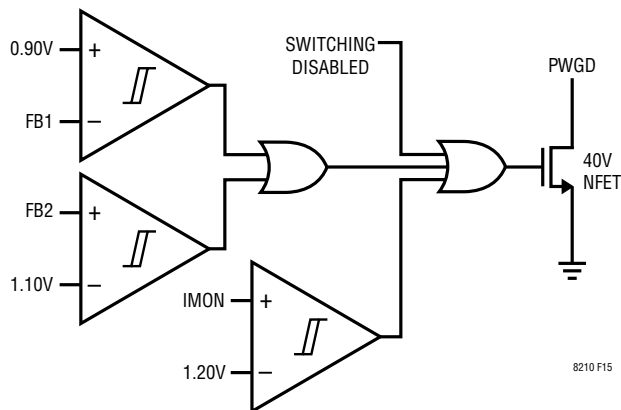

Figure 15. PWGD Logic

APPLICATIONS INFORMATION

The Applications Information section serves as a guideline for selecting external components based on the details of the application. For this section please refer to the basic LT8210 application circuit shown in Figure 16. Component selection typically follows the approach described below:

1. R_{SENSE} is selected based on the required output current and the input voltage range
2. Inductor value (L) and switching frequency (f_{sw}) are chosen based on ripple, stability and efficiency requirements.
3. Power MOSFETs (A, B, C, D) are selected to maximize efficiency while satisfying the voltage and current ranges of the application.
4. C_{IN} and C_{OUT} capacitors selected to filter input and output RMS currents and achieve the desired voltage ripple.
5. C_{BST1} , C_{BST2} , and $C_{GATEVCC}$ capacitors are selected to store adequate charge to power the gate drivers.
6. Type II compensation network designed for V_{C1} (and also V_{C2} if pass-thru mode is used).

7. C_{SS} selected to set soft-start behavior.
8. (Optional) – Reverse input protection (DG) MOSFET selected to stand-off worst case V_{INP} to V_{IN} voltage and minimize conduction loss during regulation.
9. (Optional) – Current regulation and/or monitoring implemented with R_{SENSE2} , R_{IMON} , C_{IMON} .

The examples and equations in this section assume continuous conduction mode unless otherwise noted. For pass-thru mode use $V_{OUT(BUCK)}$, $V_{OUT(BOOST)}$ in place of V_{OUT} for buck, boost calculations, respectively. All electric characteristics referred to in this section represent typical values unless otherwise specified.

Maximum Output Current and R_{SENSE} Selection

R_{SENSE} is chosen based on the required output current. With a properly selected inductor value, the maximum average inductor current is relatively independent of inductor current ripple, duty cycle, and switching region. This simplifies the selection of R_{SENSE} , which can often be an iterative process. The R_{SENSE} value in the buck region

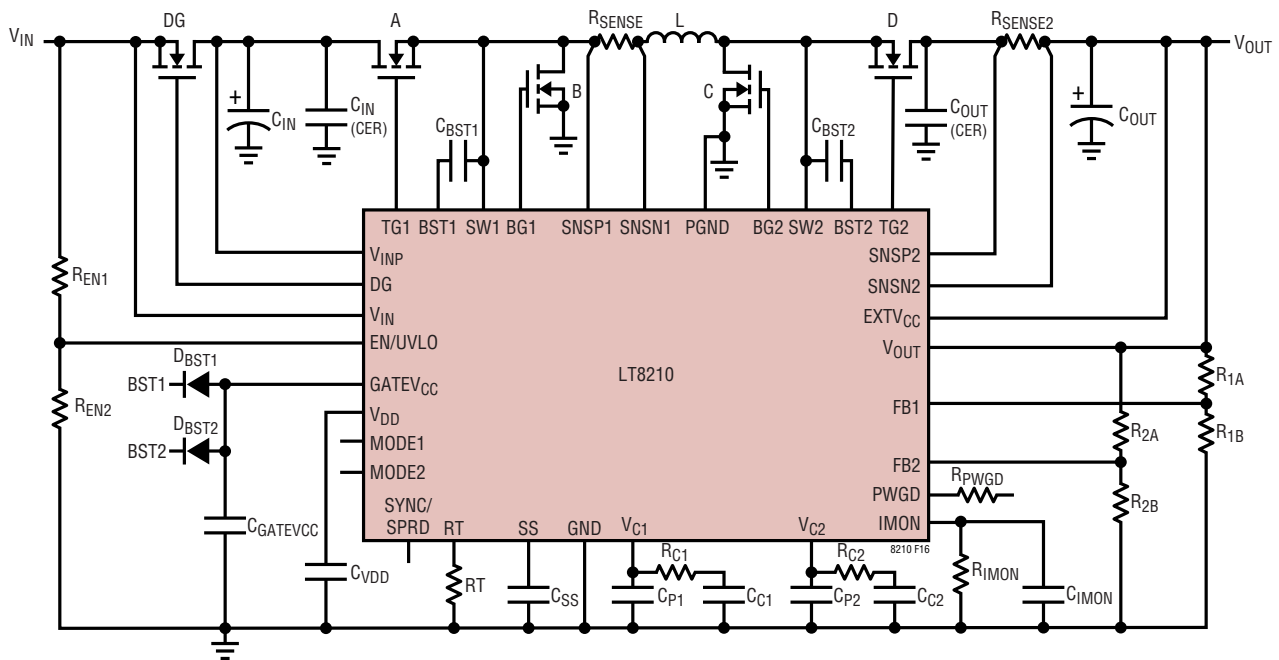

Figure 16. Basic LT8210 Applications Circuit

APPLICATIONS INFORMATION

for a given maximum output current, $I_{OUT(MAX)}$, can be calculated as:

$$R_{SENSE(BUCK)} \approx \frac{50mV}{I_{OUT(MAX)}}$$

While operating in the boost region, the output current is equal to the inductor current multiplied by $D^{1_{BST}} \approx V_{INP}/V_{OUT}$. Using $V_{INP(MIN)}$ the R_{SENSE} for a desired $I_{OUT(MAX)}$ can be calculated as:

$$R_{SENSE(BOOST)} \approx \frac{50mV}{I_{OUT(MAX)}} \cdot \frac{V_{INP(MIN)}}{V_{OUT}}$$

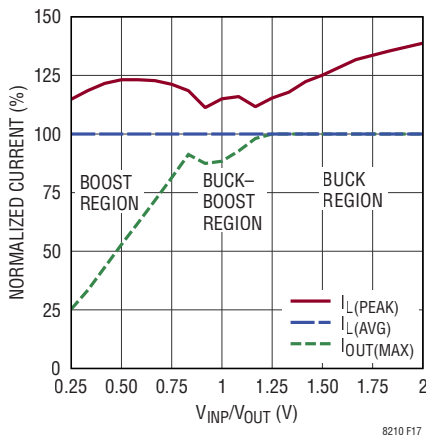

Figure 17. Example of Maximum Average Inductor Current and Output Current vs V_{INP}/V_{OUT}

A margin of 20% to 30% on the lower of the two calculated R_{SENSE} values is usually recommended. The R_{SENSE} resistor should be a low inductance type so as not to degrade stability. A small low pass filter between R_{SENSE} and the SNSP1 and SNSN1 pins like that shown in Figure 18 is not required but may improve switching edge jitter in some applications. These filter components should be placed near the pins.

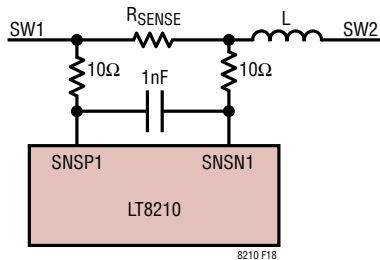

Figure 18. Optional SNSP1, SNSN1 Filter for Improved Jitter

Inductor Selection

The operating frequency and inductor selection are inter-related in that higher operating frequencies allow the use of smaller inductor and capacitor values. The inductor value is inversely related to the ripple current. Typically, the inductor ripple current, ΔI_L , is set to 20% to 40% of the maximum inductor current. The minimum inductor value necessary to maintain a desired ripple can be calculated for both buck and boost regions as:

$$L_{(BUCK)} > \frac{V_{OUT} \cdot (V_{IN(MAX)} - V_{OUT})}{f_{SW} \cdot I_{OUT(MAX)} \cdot \Delta I_L \% \cdot V_{IN(MAX)}}$$

$$L_{(BOOST)} > \frac{V_{IN(MIN)}^2 \cdot (V_{OUT} - V_{IN(MIN)})}{f_{SW} \cdot I_{OUT(MAX)} \cdot \Delta I_L \% \cdot V_{OUT}^2}$$

In addition to ripple considerations, the inductance should be large enough to prevent subharmonic oscillations. In a current mode controlled regulator, the current sense loop creates a double pole at half the switching frequency which can degrade system stability when its quality factor (Q_{CS}) is much greater than 1.0. The current sense loop damping is a function of the inductor current slope and the internal slope compensating ramp. The LT8210 slope compensation scheme is designed to provide optimal damping of the current sense loop for any input voltage when the inductor value is set to the following value.

$$L_{OPTIMAL} = (260 + (5.5 \cdot V_{OUT})) \cdot R_{SENSE} \cdot \frac{1}{f_{SW}}$$

for example :

$$L_{OPTIMAL}(V_{OUT}=12V) = 325 \cdot R_{SENSE} \cdot \frac{1}{f_{SW}}$$

$$L_{OPTIMAL}(V_{OUT}=48V) = 525 \cdot R_{SENSE} \cdot \frac{1}{f_{SW}}$$

This simplifies loop compensation as the current sense loop damping becomes independent of duty cycle and switching region. Selecting $L_{OPTIMAL}$ also optimizes line regulation and line step response. A lower inductance value will increase Q_{CS} , and a sufficiently undersized inductor can result in subharmonic oscillation for buck duty cycles above 50% and boost duty cycles below 50%. Choose an inductor at least 70% of the calculated optimal value to avoid subharmonic

APPLICATIONS INFORMATION

instability. Inductor parasitics can significantly impact converter efficiency. For high efficiency, choose an inductor with low core loss, such as ferrite. The inductor should also have low DC resistance (DCR) to reduce the I^2R losses. Selecting an inductor with DCR comparable to the $R_{DS(ON)}$ of the power MOSFETs is a reasonable starting point. If radiated noise is a concern, a shielded inductor should be used. Ferrite cores saturate abruptly leading to significant increase in ripple when the saturation current rating, I_{SAT} , is exceeded. I_{SAT} should be greater than the worst-case peak inductor current with added margin. The maximum peak inductor current can be approximated:

$$I_{L(MAX)} \approx \frac{60mV}{R_{SENSE}} + \Delta I_{L(MAX)} A$$

Assuming an inductor ripple current, $\Delta I_{L(MAX)}$, of 40%, the peak inductor current could be 145% of the maximum output current. Adding an additional margin of 25% beyond worst-case yields a conservative minimum inductor I_{SAT} rating of $90mV/R_{SENSE}$, for example.

Switching Frequency Selection

The RT frequency adjust pin allows the user to program the switching frequency from 80kHz to 400kHz. Selection of the switching frequency is a trade-off between efficiency and component size. Low frequency operation improves efficiency by reducing MOSFET switching losses, but requires larger inductor and capacitor values. For high power applications, consider operating at lower frequencies to minimize MOSFET heating from switching losses. For low power applications, consider operating at higher switching frequencies to minimize total solution size. The selection of R_{SENSE} , the inductor value and switching frequency are interrelated. To maintain the ripple current amplitude and subharmonic stability, the inductor value will track the product of R_{SENSE} and the switching period, T. The R_{SENSE} value is set by load requirements. The inductor value is determined by ripple current and subharmonic stability criteria. A practical approach is to adjust the switching frequency to optimize system performance once the R_{SENSE} and L values have already been chosen. The component selection flow would follow:

1. Select R_{SENSE} based on required output current.

2. Select inductor value based on desired ripple for a range of f_{SW} (e.g., 80kHz to 120kHz).
3. Adjust switching frequency to satisfy:

$$f_{SW(OPTIMAL)} = \frac{(260 + (5.5 \cdot V_{OUT})) \cdot R_{SENSE}}{L}$$

Setting the switching frequency to $f_{SW(OPTIMAL)}$ has a host of benefits including: optimized loop stability, optimized line rejection, and flat average maximum inductor current across duty cycle and switching region.

RT Set Switching Frequency

The switching frequency of the LT8210 is set with a resistor from the RT pin to ground. Table 2 shows switching frequency versus RT for 1% resistor values. The minimum and maximum switching frequencies are internally limited should the RT resistor be shorted (typically $f_{SW} = 700kHz$) or opened (typically $f_{SW} = 45kHz$). It is strongly recommended to use a RT resistor even when LT8210 is synchronized to an external clock using the SYNC/SPRD pin. If the synchronization signal is lost, the LT8210 will revert to the RT set value within approximately 20 μ s.

Table 2. Switching Frequency vs RT Value (1% Resistor)

RT (k Ω)	f _{sw} (kHz)	RT (k Ω)	f _{sw} (kHz)
16.2	411	41.2	190
16.9	397	43.2	184
17.8	379	45.2	177
18.7	364	47.5	171
20.0	343	49.9	165
21.0	329	52.3	160
22.1	315	54.9	155
23.2	300	59.0	147
24.3	289	64.9	138
25.5	277	71.5	130
26.7	267	78.7	122
28.0	257	86.6	115
29.4	247	95.3	109
30.9	237	100	105
32.4	229	110	100
34.0	220	121	95
35.7	212	133	90
37.4	205	150	85
39.2	200	174	80

APPLICATIONS INFORMATION

Frequency Synchronization

The LT8210 switching frequency can be synchronized to an external clock using the SYNC/SPRD pin. The threshold of the SYNC/SPRD receiver makes it compatible with standard 1.8V to 5.0V logic levels. Driving the SYNC/SPRD with a 50% duty cycle waveform is a good choice, otherwise maintain the duty cycle between 10% and 90%. Because an internal phase-locked loop (PLL) is used, there is no restriction between the synchronization frequency and the RT set oscillator frequency. The LT8210 is designed to transition seamlessly between RT set switching frequency and the external synchronization clock. If the SYNC/SPRD signal drops below 50kHz or stops altogether, the LT8210 will revert to the RT set frequency within 20 μ s (typical). Setting the RT programmed frequency near the synchronization frequency is recommended to maintain normal switching should the external clock signal be lost. When a synchronization clock is first applied the internal PLL may take 50 μ s or more to settle within 5% of the external clock frequency. When the clock synchronization feature is not used, connect SYNC/SPRD to V_{DD} to enable spread spectrum modulation, otherwise connect to GND. SYNC functionality is internally disabled while in Burst Mode operation.

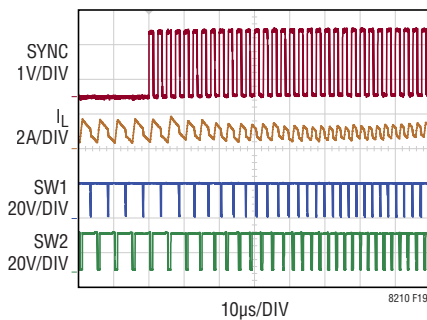

Figure 19. Transition from RT Set Frequency to Synchronization

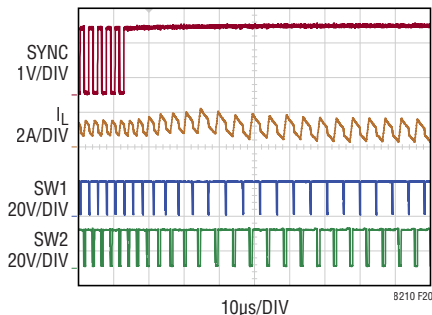

Figure 20. Transition from Synchronization to RT Set Frequency

Spread-Spectrum Frequency Modulation

Switching regulators can be particularly troublesome for applications where electromagnetic interference (EMI) is a concern. To improve EMI performance, the LT8210 includes a user selectable triangular frequency modulation scheme. When the SYNC/SPRD pin is tied to V_{DD} spread spectrum functionality is enabled. The LT8210 will slowly spread f_{SW} between the nominal RT set frequency to 112.5% of that value. Figure 21 and Figure 22 demonstrate the difference in the noise spectrum and switching waveforms with the spread spectrum feature enabled.

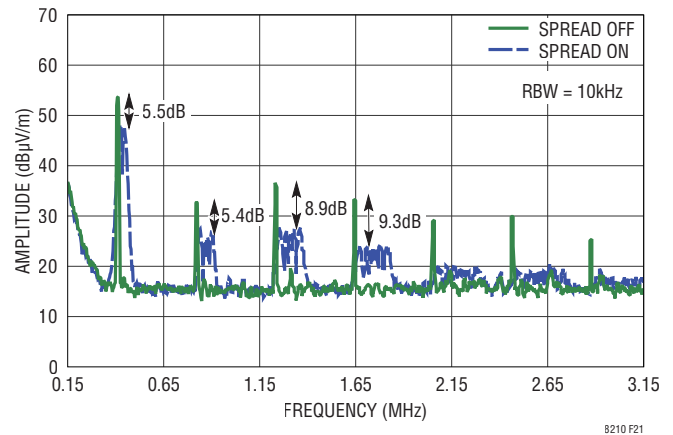

Figure 21. Conducted Average EMI Comparison (AM Band) Example

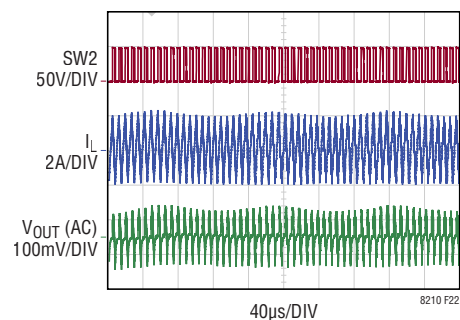

FIGURE 37 CIRCUIT
V_{IN} = 20V

Figure 22. Switching Waveforms with Spread-Spectrum Enabled

APPLICATIONS INFORMATION

Power MOSFET Selection

The LT8210 requires four external N-channel power MOSFETs (switches A, B, C, D in Figure 16). The gate drive voltage of the LT8210 is typically greater than 10V allowing the use of both logic-level and standard-level threshold devices. The MOSFET maximum $V_{BR(DSS)}$ and drain current (I_D) ratings should exceed worst-case voltage and current conditions of the application with added margin for safety. The maximum continuous drain current of a power MOSFET is de-rated as a function of temperature with that information commonly available in the data sheet. It is important to consider power dissipation when selecting power MOSFETs. The most efficient circuit will use MOSFETs that dissipate the least amount of power. Dissipated power and the resulting temperature rise in external components will set the upper bound on the power that can be delivered by the LT8210. MOSFET power dissipation comes from two primary components: (1) I^2R conduction losses when the switch is fully turned “on” and drain current is flowing, and (2) power dissipated while the switch is turning “on” or “off”. Conduction losses are independent of frequency. Switching losses, on the other hand, scale with frequency and voltage. Generally speaking, conduction losses are dominant at higher currents and lower voltages, whereas switching losses tend to dominate at lower currents and higher voltages. Accurately predicting MOSFET power dissipation is a complex problem that is best suited to efficiency calculators such as that included in LTpowerCAD® II. That being said, efficiency calculators are no substitute for real world measurements. The following section provides approximations of the main source(s) of power dissipation for switches A, B, C, and D as a function of the input and output voltages and switching region. The purpose is to guide MOSFET selection by determining where the majority of power is being dissipated. In the following equations ρ_τ is a normalization factor (unity at 25°C) accounting for the significant variation in on-resistance with temperature, typically 0.4%/°C as shown in Figure 23. For a maximum junction temperature of 125°C, using a value of $\rho_\tau = 1.5$ is reasonable. Q_{SW} is the switching charge and can be approximated as $Q_{SW} = Q_{GD} + Q_{GS}/2$ if not explicitly stated in the MOSFET data sheet.

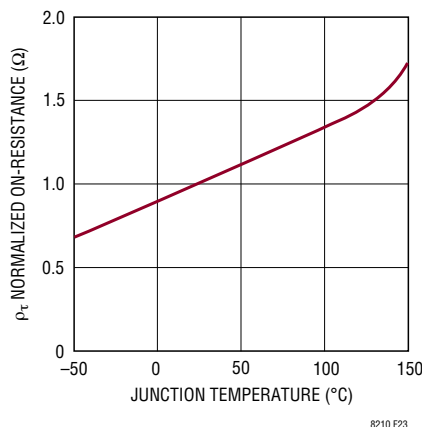

Figure 23. Normalized $R_{DS(ON)}$ vs Temperature

The constant k is empirically derived to equal 1.3 and is a function of driver resistance, MOSFET threshold and gate resistance.

Switch A: The power dissipation in switch A is due to both conduction and switching losses and typically reaches a maximum at either $V_{IN(MIN)}$ in the boost region, or $V_{IN(MAX)}$ in the buck region.

Table 3. Switch A Power Dissipation

REGION	POWER DISSIPATION
Buck	$I_{OUT}^2 \cdot (V_{OUT}/V_{IN}) \cdot \rho_\tau \cdot R_{DS(ON)}$ + $k \cdot I_{OUT} \cdot V_{IN} \cdot f_{SW} \cdot Q_{SW}$
Buck-Boost	$I_{OUT}^2 \cdot (V_{OUT}/V_{IN}) \cdot \rho_\tau \cdot R_{DS(ON)}$ + $k \cdot I_{OUT} \cdot V_{IN} \cdot f_{SW} \cdot Q_{SW}$
Boost	$I_{OUT}^2 \cdot (V_{OUT}/V_{IN})^2 \cdot \rho_\tau \cdot R_{DS(ON)}$
Pass-Thru (Non-Switching)	$I_{OUT}^2 \cdot \rho_\tau \cdot R_{DS(ON)}$

Switch B: Switch B power dissipation is due mainly to conduction losses and reaches a maximum in the buck region at $V_{IN(MAX)}$.

Table 4. Switch B Power Dissipation

REGION	POWER DISSIPATION
Buck	$I_{OUT}^2 \cdot (1 - V_{OUT}/V_{IN}) \cdot \rho_\tau \cdot R_{DS(ON)}$
Buck-Boost	$I_{OUT}^2 \cdot (1 - V_{OUT}/V_{IN}) \cdot \rho_\tau \cdot R_{DS(ON)}$
Boost	0
Pass-Thru (Non-Switching)	0

APPLICATIONS INFORMATION

Switch C: Switch C power dissipation is due to both conduction and switching losses and reaches a maximum at $V_{IN(MIN)}$.

Table 5. Switch C Power Dissipation

REGION	POWER DISSIPATION
Buck	0
Buck-Boost	$I_{OUT}^2 \cdot V_{OUT} \cdot (V_{OUT} - V_{IN}) \cdot \rho_{\tau} \cdot R_{DS(ON)} / V_{IN}^2$ + $k \cdot I_{OUT} \cdot V_{OUT}^2 \cdot f_{SW} \cdot Q_{SW} / V_{IN}$
Boost	$I_{OUT}^2 \cdot V_{OUT} \cdot (V_{OUT} - V_{IN}) \cdot \rho_{\tau} \cdot R_{DS(ON)} / V_{IN}^2$ + $k \cdot I_{OUT} \cdot V_{OUT}^2 \cdot f_{SW} \cdot Q_{SW} / V_{IN}$
Pass-Thru (Non-Switching)	0

Switch D: Switch D power dissipation is due mainly to conduction losses and reaches a maximum in the boost region at $V_{IN(MIN)}$.

Table 6. Switch D Power Dissipation

REGION	POWER DISSIPATION
Buck	$I_{OUT}^2 \cdot \rho_{\tau} \cdot R_{DS(ON)}$
Buck-Boost	$I_{OUT}^2 \cdot (V_{OUT} / V_{IN}) \cdot \rho_{\tau} \cdot R_{DS(ON)}$
Boost	$I_{OUT}^2 \cdot (V_{OUT} / V_{IN}) \cdot \rho_{\tau} \cdot R_{DS(ON)}$
Pass-Thru (Non-Switching)	$I_{OUT}^2 \cdot \rho_{\tau} \cdot R_{DS(ON)}$

In most applications the losses reach a maximum when the LT8210 is delivering $I_{OUT(MAX)}$ at $V_{IN(MIN)}$. Switches A and C will typically dissipate the majority of the power in these situations. To achieve higher output current it may be beneficial to use two MOSFETs in parallel for switches A and C to minimize conduction losses. While the power dissipated in switches B and D is comparatively low during normal operation, it may become significant if the output is shorted to ground. A representative example of switch power dissipation as a function of input voltage is shown in Figure 24.

Other power loss sources include: the gate drive current ($f_{SW} \cdot \Sigma$ switching MOSFET Q_G) multiplied by the supply voltage of the $GATEV_{CC}$ regulator (either V_{INP} or V_{EXTVCC}),

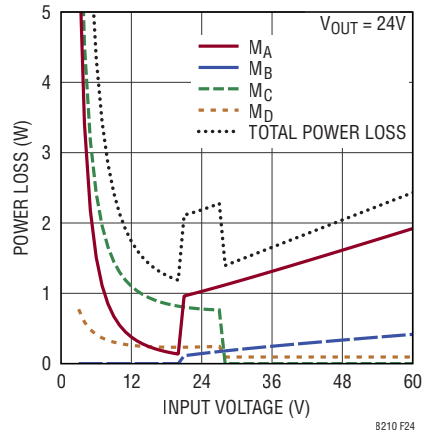

Figure 24. Example of Switch Power Dissipation vs V_{INP}

as well as the energy required to charge MOSFET Q_{OSS} , Q_{RR} each switching cycle depending on switching region. Power MOSFETs of a particular technology trade on-resistance, $R_{DS(ON)}$, and gate charge Q_G (along with Q_{SW} , Q_{OSS} , Q_{RR}) and maximizing efficiency often comes down to finding a MOSFET that strikes the right balance between these factors. Higher switching frequency and higher voltage operation drive up switching losses making the value of Q_G (and Q_{SW} , Q_{OSS} , Q_{RR}) increasingly significant. In the non-switching pass-thru state, efficiency depends primarily on conduction losses in power switches A, D, and DG (if used) along with the inductor DCR. In these situations prioritize low $R_{DS(ON)}$ over Q_G to maximize efficiency.

C_{IN} and C_{OUT} Selection

Input and output capacitors are necessary to suppress the voltage ripple caused by discontinuous current moving in and out of the regulator. In the buck region the input current is discontinuous while in the boost region the output current is discontinuous. Selecting the proper input and output capacitors boils down to three considerations:

1. Voltage ripple is inversely proportional to capacitance.
2. ESR must be low to minimize its contribution to voltage ripple.
3. RMS current rating of the capacitor(s) should exceed worst-case application conditions with margin.

APPLICATIONS INFORMATION

For buck operation, the value of C_{IN} to achieve a desired input ripple voltage (ΔV_{IN}) can be calculated as:

$$C_{IN} \approx \frac{I_{OUT(MAX)}}{\Delta V_{IN} \cdot f_{sw}} \cdot \left(\frac{V_{OUT}}{V_{IN}} \right) \cdot \left(1 - \frac{V_{OUT}}{V_{IN}} \right)$$

ΔV_{IN} is typically chosen at a level acceptable to the user. 100mV to 200mV is a good starting point. The ESR of the input capacitance should be less than:

$$ESR_{(IN,MAX)} < \frac{\Delta V_{IN}}{I_{OUT(MAX)}}$$

The input RMS current can be approximated by:

$$I_{IN(RMS)} \approx I_{OUT(MAX)} \cdot \frac{V_{OUT}}{V_{IN}} \cdot \sqrt{\frac{V_{IN}}{V_{OUT}} - 1}$$

This formula has a maximum at $V_{IN} = 2V_{OUT}$, where $I_{RMS} = I_{OUT(MAX)}/2$. This simple worst-case condition is commonly used for design because even significant deviations do not offer much relief. The capacitance necessary to achieve a desired output ripple, ΔV_{OUT} , can be calculated for the buck and boost switching regions:

$$C_{OUT(BOOST)} = \frac{I_{OUT(MAX)} \cdot (V_{OUT} - V_{IN(MIN)})}{\Delta V_{OUT} \cdot f_{sw} \cdot V_{OUT}}$$

$$C_{OUT(BUCK)} = \frac{V_{OUT} \cdot (V_{IN(MAX)} - V_{OUT})}{\Delta V_{OUT} \cdot f_{sw}^2 \cdot V_{IN(MAX)} \cdot 8 \cdot L}$$

The ESR of the output capacitor should be low enough to not significantly increase the ripple voltage:

$$ESR_{(BOOST)} < \frac{\Delta V_{OUT} \cdot V_{IN(MIN)}}{I_{OUT(MAX)} \cdot V_{OUT}}$$

$$ESR_{(BUCK)} < \frac{\Delta V_{OUT} \cdot L \cdot f_{sw}}{V_{OUT} \cdot \left(1 - \frac{V_{OUT}}{V_{IN(MAX)}} \right)}$$

C_{OUT} should also tolerate the maximum RMS output current of when operating in the boost region:

$$I_{OUT(RMS)} \approx I_{OUT(MAX)} \cdot \sqrt{\frac{V_{OUT}}{V_{IN(MIN)}} - 1}$$

For both the C_{IN} and C_{OUT} capacitors, a good approach for larger values is to use a parallel combination of aluminum electrolytics for bulk capacitance and ceramics for low ESR and to handle the RMS currents. When used together, the percentage of RMS current that will flow through the aluminum electrolytic capacitor can be approximated by the following equation:

$$\% I_{RMS,ALUM} \approx \frac{100\%}{\sqrt{1 + (2\pi \cdot f_{sw} \cdot C_{(CER)} \cdot R_{ESR(ALUM)})^2}}$$

Where $R_{ESR(ALUM)}$ is the ESR of the aluminum capacitor and $C_{(CER)}$ is the total value of the ceramic capacitor(s). Ceramic capacitors should be placed near the regulator input and output to suppress high frequency switching spikes. Specifically, the ceramic capacitors on the input should be placed in close proximity to switches A and B, and output ceramics should be placed close to switches C and D. Due to their excellent low ESR characteristics, ceramic capacitors can significantly reduce ripple voltage and help reduce power loss in higher ESR bulk capacitors. X5R and X7R are preferred, as these materials retain their capacitance over wide voltage and temperature ranges. At higher input and output voltages multiple ceramic capacitors in parallel may be needed due to limited availability of high voltage, large value ceramic capacitors in standard footprints. In situations with high input and/or output voltage ripple a RC low-pass filter with time constant of 1 μ s or greater is recommended for V_{INP} and V_{OUT} inputs to maintain low jitter on switching edges.

Bootstrap Capacitors (C_{BST1} , C_{BST2})

The top MOSFET gate drive signals, TG1 and TG2, are driven between their respective BST and SW pin voltages. The BST1 and BST2 voltages are biased from floating bootstrap capacitors C_{BST1} and C_{BST2} , which are normally recharged from $GATEV_{CC}$ through diodes D_{BST1} and D_{BST2} when their respective top MOSFET is off. The bootstrap capacitors C_{BST1} and C_{BST2} need to store roughly 100 times the gate charge (Q_G) required by top switches A and D. In most situations, a 0.1 μ F to 0.47 μ F, X5R or X7R, 25V capacitor is adequate. The bypass capacitance from $GATEV_{CC}$ to ground should be at least ten times the value

APPLICATIONS INFORMATION

of the C_{BST1} , C_{BST2} capacitors. The rise times of the SW1 and SW2 pins can be slowed down through the addition of series resistors between the respective bootstrap capacitors and the BST1 or BST2 pins. The slowing down of the switch edges can improve overshoot but may also degrade efficiency due to increased transitional losses.

Bootstrap Diodes (D_{BST1} , D_{BST2})

Silicon diodes rated for 1A with very fast reverse recovery time (<50ns) are recommended for the bootstrap diodes, D_{BST1} and D_{BST2} . Although Schottky diodes have the benefit of low forward drops, they can exhibit high reverse current leakage and have the potential for thermal runaway under high voltage and temperature conditions. Make sure that D_{BST1} and D_{BST2} have reverse breakdown voltage ratings higher than $V_{INP(MAX)}$ and $V_{OUT(MAX)}$, respectively, and have less than 50 μ A of reverse leakage at the maximum operating temperature. In pass-thru mode low reverse leakage is critical. The bootstrap diode leakage current will have a disproportionate effect on quiescent current due to the limited efficiency of the internal charge pump. For pass-thru use diodes with reverse leakage currents 10 μ A or less at the maximum operating temperature. In some cases, it can be beneficial to add a small resistor (<5 Ω) in series with D_{BST1} and D_{BST2} . The resistors reduce surge currents in the diodes and can reduce ringing at the SW and BST pins of the IC. Since SW pin ringing is highly dependent on PCB layout, SW pin edge rates and the types of diodes used, careful measurements directly at the SW pins of the IC are recommended. If required, a single resistor can be placed between GATEV_{CC} and the anodes of both D_{BST1} and D_{BST2} or by placing separate resistors between the cathodes of each diode and the respective BST pins. Excessive resistance in series with D_{BST1} and D_{BST2} can reduce the bootstrap capacitor voltage when the switch B and C on-times are very short and should be avoided.

EXTV_{CC}, GATEV_{CC} and V_{DD}

GATEV_{CC} is the power supply for the gate drivers and should be bypassed with a minimum 4.7 μ F, 25V, ceramic capacitor to ground placed close to the pin. Good local

bypass is necessary to supply the high transient current required by the MOSFET gate drivers. The GATEV_{CC} voltage is regulated to 10.6V from PMOS low-dropout regulators powered from the V_{INP} or EXTV_{CC} pins. V_{INP} is the default power supply but if the voltage on EXTV_{CC} exceeds 8V (typical) and is simultaneously lower than the V_{INP} voltage, GATEV_{CC} will be regulated from EXTV_{CC}. The LT8210 automatically selects the lower of these two supplies to minimize power dissipation. The comparison criteria is invalid when V_{INP} drops below 8.5V to allow EXTV_{CC} to hold up GATEV_{CC} during input brownouts. EXTV_{CC} can be connected to V_{OUT} or any supply up to 40V for improved system efficiency. If not used, EXTV_{CC} should be tied to ground through a 100k resistor. The maximum current the GATEV_{CC} regulator can supply is typically 110mA at $V_{IN} = 12V$ and drops linearly at higher voltages. This limits the internal power dissipation of the LT8210 to roughly 3W. The GATEV_{CC} current limit foldback helps prevent triggering a thermal shutdown (typically 175°C) due to excessive internal power dissipation. The current limit should be considered when selecting power MOSFETs and setting the switching frequency. $I_{GATEVCC}$ is dominated by gate charge current which reaches a maximum in the buck-boost region when all four power MOSFETs are switching. The peak gate drive current is equal to the product of f_{SW} and the sum of the MOSFET gate charges ($Q_{G(TOT)} = Q_{G(A)} + Q_{G(B)} + Q_{G(C)} + Q_{G(D)}$). The GATEV_{CC} pin is backdrive-protected should the voltage on either the V_{INP} or EXTV_{CC} drop below GATEV_{CC}. This can be a useful feature, allowing the LT8210 to maintain operation during input brownout conditions even when EXTV_{CC} is not used. The length of time GATEV_{CC} is able to ride-through an input transient will depend on $I_{GATEVCC}$ and the size of its bypass capacitor. The GATEV_{CC} regulator is stable with capacitors up to 220 μ F for flexibility in designing for many millisecond ride-through conditions. The V_{DD} pin is regulated to 3.3V from GATEV_{CC} with a low-dropout PMOS regulator. The V_{DD} pin powers internal low-voltage circuitry within the LT8210 and can source a maximum of 10mA. It should be bypassed with a minimum 2.2 μ F X5R/X7R capacitor to ground placed close to the pin. The V_{DD} supply is a convenient pull-up rail for the MODE1, MODE2, SYNC, and PWGD pins when tying those inputs

APPLICATIONS INFORMATION

logic high. For powering loads other than those specified please contact the factory for support.

Programming Output Voltage

The LT8210 has a voltage feedback pin FB1 that is used to program a constant output voltage when the LT8210 is configured for CCM, DCM, or Burst Mode operation. The output voltage can be set by selecting the values of R_{1A} and R_{1B} (Figure 25) according to the following equation:

$$V_{OUT} = 1.00V \cdot \frac{R_{1A} + R_{1B}}{R_{1B}}$$

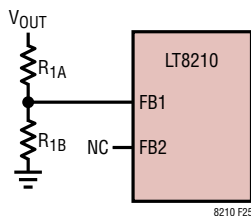

Figure 25. Setting the Output Voltage for CCM, DCM, Burst Mode Operation Switching Modes

In pass-thru mode, the output voltages for the buck and boost channels are programmed independently (Figure 26) according to the following equations:

$$V_{OUT(BOOST)} = 1.00V \cdot \frac{R_{1A} + R_{1B}}{R_{1B}}$$

$$V_{OUT(BUCK)} = 1.00V \cdot \frac{R_{2A} + R_{2B}}{R_{2B}}$$

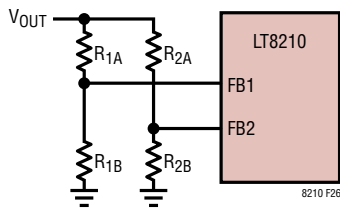

Figure 26. Setting the Output Voltage Window for Pass-Thru Mode

The FB1 and FB2 dividers can also be set with a single string of three resistors as shown in Figure 27 to reduce system quiescent current:

$$V_{OUT(BOOST)} = 1.00V \cdot \frac{R_{1A} + R_{1B} + R_{1C}}{R_{1B} + R_{1C}}$$

$$V_{OUT(BUCK)} = 1.00V \cdot \frac{R_{1A} + R_{1B} + R_{1C}}{R_{1C}}$$

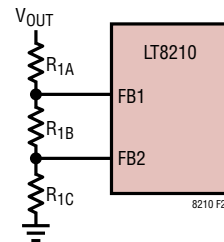

Figure 27. Power Saving Feedback Resistor Connection in Pass-Thru Mode

If pass-thru mode is exited during operation, the FB1 and FB2 pins will be shorted with an internal switch creating a composite value for V_{OUT} between $V_{OUT(BOOST)}$ and $V_{OUT(BUCK)}$. The relative magnitude of the FB1, FB2 resistive dividers can be used to place V_{OUT} at a desired value between $V_{OUT(BOOST)}$ and $V_{OUT(BUCK)}$.

$$V_{OUT} = 1.00V \cdot \frac{R_{1A} \parallel R_{2A} + R_{1B} \parallel R_{2B}}{R_{1B} \parallel R_{2B}}$$

If the resistor configuration shown in Figure 27 is used for defining the pass-thru window top and bottom, V_{OUT} will equal $V_{OUT(BUCK)}$ when exiting pass-thru.

Programming Input or Output Current Limit

As shown in Figure 28 and Figure 29, input or output current regulation can be implemented with a current sense resistor, R_{SENSE2} , placed in the current path near the input or output capacitors, respectively. A current equal to $600\mu A/V$ times the $SNSP2 - SNSN2$ voltage is sourced

APPLICATIONS INFORMATION

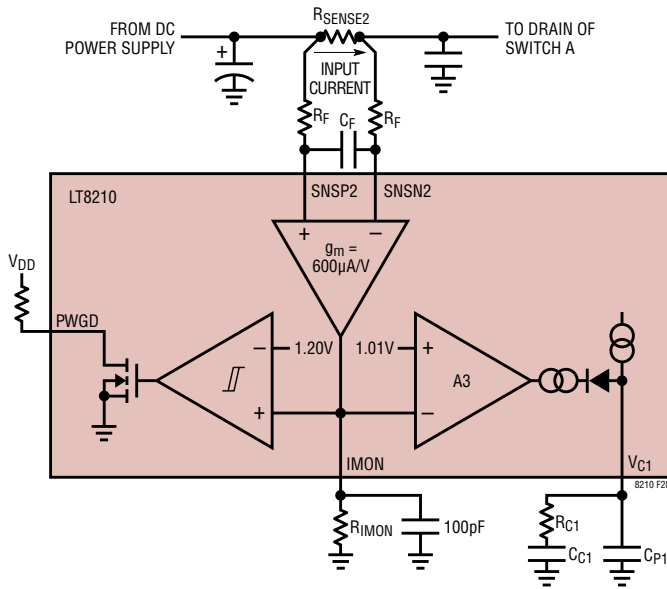

Figure 28. Input Current Monitor and Limit Using Input Filter

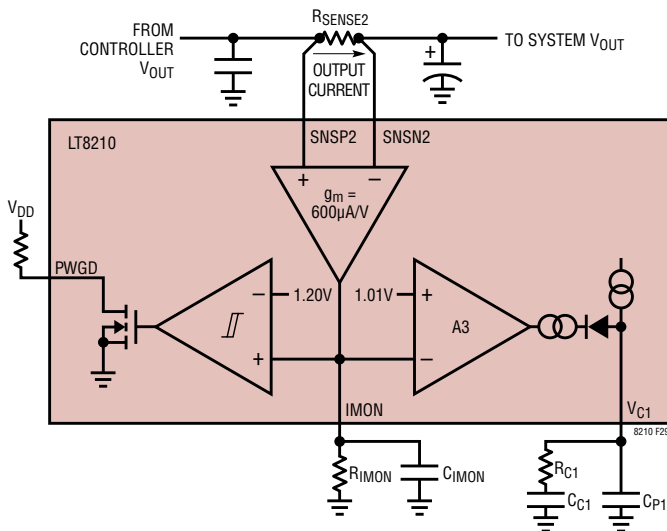

Figure 29. Output Current Monitor and Limit Using CIMON Filter

from the IMON pin and into R_{IMON}. The average current limit is set with the values of the sense resistor, R_{SENSE2}, and the R_{IMON} resistor and be calculated:

$$I_{LIMIT} = \frac{1675}{R_{IMON} \cdot R_{SENSE2}}$$

In high current applications it is advantageous to keep the value of R_{SENSE2} low to minimize conduction loss. In situations that call for higher precision one might choose a larger R_{SENSE2} resistor to increase the sensed signal amplitude for improved accuracy. The current sense amplifier remains linear for differential input signals up to 150mV for this reason. An input low pass filter formed by R_F and C_F shown in Figure 28 is one method to reduce the switching noise and stabilize the current regulation loop. A typical range for the R_F resistor would be 10Ω to 100Ω. The C_F capacitor is selected to place the low pass corner frequency at 1/50 the switching frequency, f_{SW}. This is the preferred method for compensating the current regulation loop when the LT8210 is operated in CCM. Filtering the current sense input signal reduces the error that occurs when the inductor current reverses at light loads. When using input filter compensation a minimum 22pF capacitor should be placed in parallel with R_{IMON} to reduce noise sensitivity. For DCM, Burst Mode operation, or pass-thru operation a simpler approach for compensation shown in Figure 29 is to place a capacitor, C_{IMON}, in parallel with R_{IMON}. C_{IMON} should be sized so that the current loop's transfer function approximates that of the voltage loop. Crossover frequency should be less than one-tenth the switching frequency. In practice this leads to a minimum C_{IMON} value of roughly 15nF. Larger C_{IMON} values will improve stability but increase current regulation loop settling time. The PWGD pin is used to indicate excessive average current and is pulled low when the IMON voltage exceeds 1.20V. If the current sense amplifier is unused, SNSP2 and SNSN2 should be connected to ground and the IMON pin connected to V_{DD} to disable the current sense amplifier and minimize quiescent current.

APPLICATIONS INFORMATION

Programming V_{IN} UVLO

A resistor divider from V_{IN} to the EN/UVLO pin implements V_{IN} undervoltage lockout (UVLO). The EN/UVLO falling threshold is set at 1.35V with 100mV of hysteresis. The programmable UVLO threshold can be calculated as:

$$V_{UVLO} = 1.35V \cdot \frac{R_1 + R_2}{R_2}$$

Figure 30 shows the implementation of external shutdown control while still using the UVLO function. The NMOS grounds the EN/UVLO pin when turned on, and puts the LT8210 into shutdown with a quiescent current around 1 μ A. If the functionality of the EN/UVLO pin is not needed, connect to the V_{IN} pin for ‘always on’ operation.

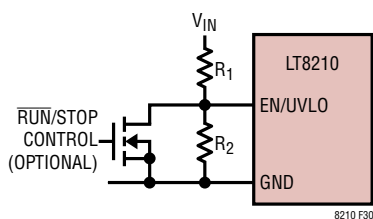

Figure 30. V_{IN} UVLO Implementation Using the EN/UVLO Pin

Soft-Start

Soft-start reduces the input power sources surge current by gradually increasing the controller’s current limit. Both the V_{C1} and V_{C2} pins are internally clamped to a diode voltage above the SS pin voltage. As the SS capacitor is charged, V_{C1} and V_{C2} ramp along with SS and the commanded inductor current ramps in a similar fashion. The soft-start interval will be a function of C_{SS} , C_{OUT} , V_{OUT} and R_{SENSE} and can be approximated:

$$t_{SS} \approx 2000 \cdot \sqrt{C_{SS} \cdot C_{OUT} \cdot V_{OUT} \cdot R_{SENSE}}$$

This assumes buck region operation and that the inductor current does not reach its cycle-by-cycle maximum during start-up. If starting up into the boost switching region or if the inductor current reaches its limit the soft-start time will be extended. If no C_{SS} is used, the inductor current will quickly ramp to its maximum value and the output voltage ramp time can be approximated:

$$t_{SS} \approx 20 \cdot C_{OUT} \cdot V_{OUT} \cdot R_{SENSE}$$

Determining the value of C_{SS} empirically with a capacitance decade box is often the most straightforward approach. In pass-thru mode use $C_{SS} \leq 10nF$.

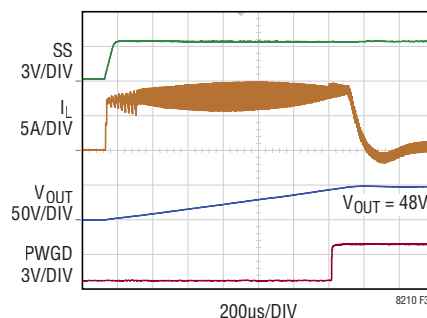

Figure 31. Typical Start-Up with No C_{SS}

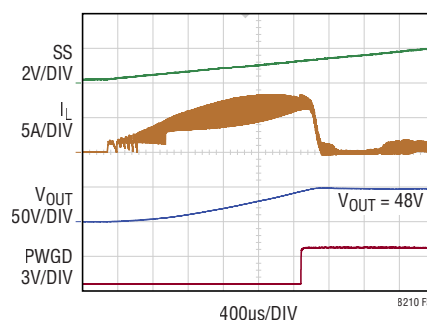

Figure 32. Typical Start-Up with $C_{SS} = 10nF$

Loop Compensation

The loop stability is affected by a number of factors including the inductor value, output capacitance, load current, switching frequency and the range of input and output voltages. The LT8210 uses internal transconductance amplifiers with outputs at V_{C1} and V_{C2} to compensate the control loop(s). The Type II compensation network used to compensate the LT8210 is shown in Figure 33 and Figure 34. For most applications, a C_{C1} of 2.2nF is a good starting point. Smaller values of C_{C1} can improve settling time after a load transient. C_{P1} is used to filter switching noise and reduce jitter and is typically set at one tenth the value of C_{C1} or less. Increasing the value of C_{P1} may improve the jitter performance between switching bursts in Burst Mode and pulse-skipping operation. If the C_{P1} value is set too high it may degrade loop bandwidth and phase margin. The R_{C1} value can range from less than

APPLICATIONS INFORMATION

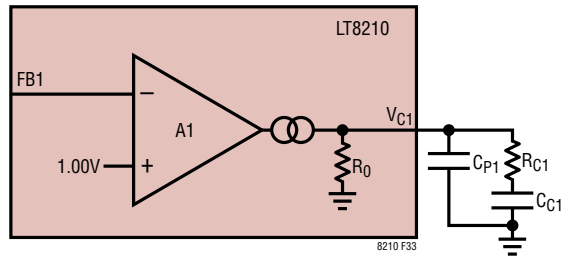

Figure 33. Loop Compensation on VC1

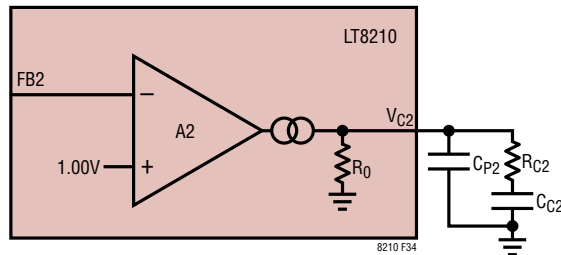

Figure 34. Loop Compensation on VC2

5k to more than 100k. Higher R_{C1} values will improve loop bandwidth, possibly at the expense of phase margin. The compensation of a buck-boost regulator depends strongly on the details of the boost region operation due to the presence of the right-half plane zero in the control-to-output transfer function. Higher output currents and lower minimum D'_{BST} ($V_{INP(MIN)}/V_{OUT}$) will require more conservative compensation, translating to a lower value for R_{C1} . The V_{C2} pin is used for compensating the buck regulation loop when the LT8210 is operated in pass-thru mode. The buck current mode control transfer function does not contain a right-half plane zero allowing it to be compensated more aggressively for improved transient response. For most applications, a C_{C2} of 1.5nF is a good starting point. A C_{P2} of 100pF to 220pF is typically sufficient for filtering switching noise. Choose an R_{C2} value between 20k and 150k to start your design. For a more detailed description of Type II compensation for current mode control please refer to Application Note 149.

Optional DG MOSFET Selection

To implement reverse protection an N-channel MOSFET must be placed with its source at the V_{IN} pin, drain at V_{INP} pin and its gate tied to DG. The important considerations for the DG MOSFET selection include breakdown

voltage $V_{BR(DSS)}$, continuous drain current (I_D) and on resistance ($R_{DS(ON)}$) as this degrades converter efficiency through conduction loss. The breakdown voltage of the DG MOSFET should be greater than the worst-case voltage difference between V_{INP} and V_{IN} . The continuous drain current of the DG MOSFET should exceed the maximum input current ($50mV/R_{SENSE}$) at the maximum temperature. While the gate charge (Q_G) of the DG MOSFET does not degrade system efficiency, a larger Q_G will increase both start-up time and reverse input protection response time. In most cases, it is beneficial to choose a lower $R_{DS(ON)}$ MOSFET at the expense of higher Q_G to minimize power dissipation. When the V_{IN} voltage drops below $-1.2V$ (typical) the DG pin is internally clamped to V_{IN} with a low resistance switch capable of sinking 80mA. For a power MOSFET with a gate charge of 50nC, the DG will be shorted to V_{IN} within 1 μ s after a negative input voltage is detected. Switching is halted in this state and only resumes when the input is no longer reversed and the DG $-V_{IN}$ voltage is charged above its undervoltage threshold of 2.8V (typical). The V_{IN} , EN/UVLO and DG pins tolerate negative voltages down to $-40V$. If reverse protection is not needed V_{IN} and V_{INP} should be connected and a 1nF, 25V capacitor placed between V_{IN} and DG.

Component Optimization for Pass-Thru Operation

Special consideration must be given to component selection to optimize performance when operating in the pass-thru region. When the LT8210 enters the non-switching pass-thru state, switches A and D turn on continuously forming an RLC tank circuit between V_{INP} and V_{OUT} . In this non-switching pass-thru state efficiency is determined by conduction losses in the total series resistance between input and output.

$$\eta = 100\% \cdot \frac{P_{OUT}}{P_{IN}} = 100\% \cdot \frac{(V_{IN} - I_{OUT} \cdot R_{SERIES})}{V_{IN} \cdot (I_{OUT} + I_Q)}$$

$$\eta = 100\% \cdot \left(1 - \frac{I_{OUT} \cdot R_{SERIES}}{V_{IN}} \right)$$

$$R_{SERIES} = R_{DS(ON)(A)} + R_{SENSE} + R_{DCR} + R_{DS(ON)(D)} + R_{SENSE2}$$

APPLICATIONS INFORMATION

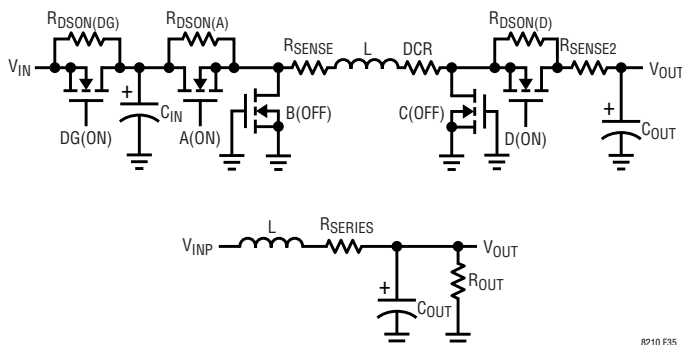

Figure 35. Non-Switching Pass-Thru Equivalent Circuit

R_{SERIES} should be minimized to maintain efficiency at higher output currents. If reverse input protection is implemented, the $R_{DS(ON)}$ of the DG MOSFET must also be accounted for in efficiency calculations. The quality factor of the RLC network between V_{INP} and V_{OUT} strongly affects the inductor current and output voltage response due to line and load transients and should be minimized wherever possible, this quality factor, Q , can be approximated as:

$$Q \cong \sqrt{\frac{L}{C_{OUT}}} \cdot \frac{1}{R_{SERIES}}$$

While beneficial for efficiency, low series resistance leads to high Q and underdamped transient response. Without increasing R_{SERIES} the quality factor can be reduced either by decreasing the inductor value or increasing the output capacitance. A lower inductor value requires operating at a higher switching frequency to maintain ripple performance and sub-harmonic stability while switching. Depending on the details of the application this can be a good approach if the input voltage is expected to be within the pass-thru window the majority of the time and lower efficiency due to increased switching losses is not a major concern. Otherwise, increasing the output capacitance is a more or less benign approach for lowering Q other than possibly requiring adjustment to the loop compensation. The resonant frequency of the RLC network can be calculated as:

$$f_0 = \frac{1}{2\pi} \cdot \sqrt{\frac{1}{L \cdot C_{OUT}}}$$

Generally speaking, the output closely tracks the input for frequencies below resonance. Above the resonant frequency the majority of the AC voltage from the input shows up as voltage across the inductor. The LT8210 monitors the inductor's voltage and current in the non-switching state and switching will resume if the inductor current exceeds the pass-thru DC current limit (typically, $V_{SNSP1} - V_{SNSN1} > 63mV$) or if the difference in voltage between V_{INP} and V_{OUT} exceeds 4% of the input voltage. This means that the total series resistance between V_{INP} and V_{OUT} should be sized less than:

$$R_{DS(ON)(A)} + R_{SENSE} + R_{DCR} + R_{DS(ON)(D)} \ll \frac{0.04 \cdot V_{OUT(BOOST)}}{I_{OUT(MAX)}}$$

If the input supply noise has amplitude greater than 4% of the nominal value at frequencies above resonance consider adding an input filter to reduce high frequency content and minimize/prevent switching in the pass-thru region. The load transient response in the pass-thru region is determined primarily by the ESR of the output capacitor which should be kept low through use of parallel ceramic capacitors. The ESR of the bulk output capacitor should also be kept relatively low as this determines the output impedance near resonance. The soft-start capacitor, C_{SS} , controls the ramping of the inductor current whenever the LT8210 exits the non-switching pass-thru state due to a line or load transient or mode change. A C_{SS} value greater than 10nF may slow the output response at this non-switching to switching transition and should be verified in the application under worst case transient conditions. Efficiency at light loads ($I_{OUT} < 10mA$) and system quiescent current draw are optimized through use of large value resistors for the FB1, FB2, and EN/UVLO (if an input UVLO is implemented) dividers. If possible, use a single 3 resistor divider between the output and ground to program $V_{OUT(BOOST)}$ and $V_{OUT(BUCK)}$.

Efficiency Considerations

The efficiency of a switching regulator is equal to the output power divided by the input power times 100%. It is often useful to analyze individual losses to determine what

APPLICATIONS INFORMATION

is limiting the efficiency and which change would produce the most improvement. Although all dissipative elements in the circuit produce losses, these are the main sources of losses in LT8210 circuits:

1. **Switching Losses.** These losses arise from the brief amount of time switch A or switch C spends in the saturated region during SW1, SW2 node transitions, respectively. Power loss depends upon the input voltage, output voltage, load current, driver strength and MOSFET capacitance, among other factors. See the Power MOSFET Selection section for more details.
2. **DC I^2R Losses.** These arise from the resistances of the MOSFETs, sensing resistors, inductor and PC board traces and cause the efficiency to drop at high output currents.
3. **GATEV_{CC} Current.** The sum of the MOSFET driver current, V_{DD} pin current and control currents. The GATEV_{CC} regulator's power supply voltage times the current represents lost power. This loss can be reduced by supplying GATEV_{CC} current through the EXT_{VCC} pin from a high efficiency source, such as the output or alternate supply if available. Lower Q_G MOSFETs can reduce GATEV_{CC} current and power loss as can lowering the switching frequency.
4. **C_{IN} and C_{OUT} Loss.** The input capacitor has the difficult job of filtering the large RMS input current to the regulator in buck mode. The output capacitor has the difficult job of filtering the large RMS output current in boost mode. Both C_{IN} and C_{OUT} are required to have low ESR to minimize the AC I^2R loss and sufficient capacitance to prevent the RMS current from causing additional upstream losses in fuses or batteries.
5. **Other Losses.** Inductor core loss occurs predominately at light loads.
6. **When making adjustments to improve efficiency,** the input current is the best indicator of changes in efficiency. If one makes a change and the input current decreases, then the efficiency has increased. If there is no change in input current, then there is no change in efficiency.

PC Board Layout Checklist

The basic circuit board layout requires a dedicated ground plane layer. Also, for high current, a multilayer board provides heat sinking for power components.

- The ground plane layer should not have any traces and should be as close as possible to the layer with the power MOSFETs.
- Separate the power ground from the signal ground. The power ground should connect to the (–) terminals of C_{IN}, C_{OUT}, C_{GATEVCC}, and the sources of switches B and C. All small-signal components and compensation components should connect to a separate signal ground which in turn connects to the PCB ground at one location away from high currents and switching noise. The GND pin and back tab must connect to this signal ground.
- Place switch A, switch B and the input capacitor(s) in one compact area with short PC trace lengths.
- Place switch C, switch D and the output capacitor(s) in one compact area with short PC trace lengths.
- Minimize the routing resistance from the TG1 and BG2 pins to power switches A and C, respectively.
- Use planes for V_{IN}, V_{INP}, and V_{OUT} to maintain good voltage filtering and to keep power losses low.
- The SW1 and SW2 planes should be wide enough to provide low resistance connections between the power switches, inductor and sense resistor, but otherwise as compact as possible to minimize parasitic capacitance.
- Route the inductor current sense traces (SNSP1/N1) together with minimum PC trace spacing. The optional filter network capacitor between positive and negative sense traces should be as close as possible to the IC. Ensure accurate current sensing with Kelvin connections at the R_{SENSE} resistor.

APPLICATIONS INFORMATION

- Route the average current sense traces (SNSP2/N2) together with minimum PC trace spacing. Avoid crossing or running parallel to high dV/dT signals. The optional filter network capacitor between positive and negative sense traces should be as close as possible to the IC. Ensure accurate current sensing with Kelvin connections at the R_{SENSE2} resistor.
- Keep the high dv/dt nodes SW1, SW2, BST1, BST2, TG1, TG2, SNSP1 and SNSN1 away from sensitive small-signal nodes.
- Avoid running signal traces parallel to the traces that carry high di/dt current because they can receive inductively coupled voltage noise. This includes the SW1, SW2, TG1, TG2, BG1 and BG2 traces to the controller.
- Connect the top driver bootstrap capacitor, C_{BST1} , closely to the BST1 and SW1 pins. Connect the top driver bootstrap capacitor, C_{BST2} , closely to the BST2 and SW2 pins.
- Connect the FB1 and FB2 pin resistor dividers between the (+) terminal of C_{OUT} and signal ground. The resistor connections should not be along the high current or noise paths.
- If $EXTV_{CC}$ is connected to V_{OUT} it should have a Kelvin connection to the (+) terminal of C_{OUT} and a ceramic bypass capacitor should be placed close to the $EXTV_{CC}$ pin.
- Connect the V_{C1}/V_{C2} pin compensation networks closely to the IC, between V_{C1}/V_{C2} and the signal ground pins. The capacitor helps to filter the effects of PCB noise and output voltage ripple voltage from the compensation loop.
- Connect the $GATEV_{CC}$ and V_{DD} bypass capacitors close to the IC. The capacitors carry the MOSFET drivers' current peaks.
- Flood all unused areas on all layers with copper. Flooding with copper will reduce the temperature rise of power components. Connect the copper areas to a DC net (e.g., quiet GND).

TYPICAL APPLICATIONS

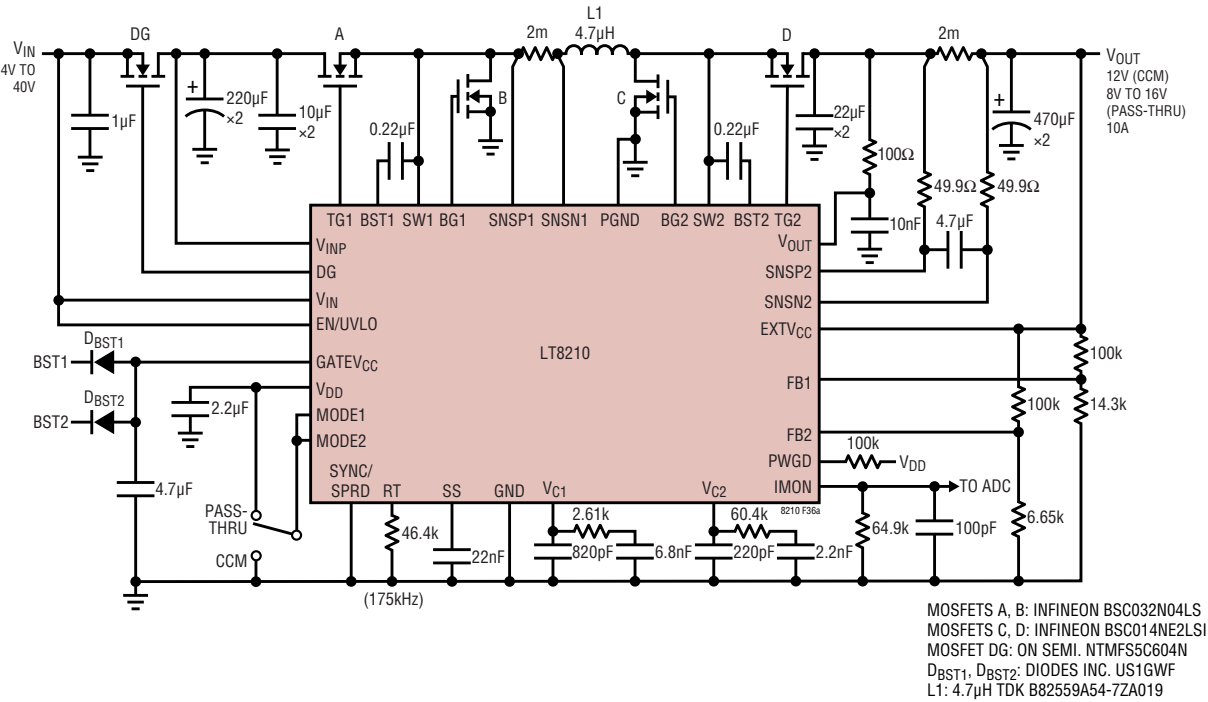
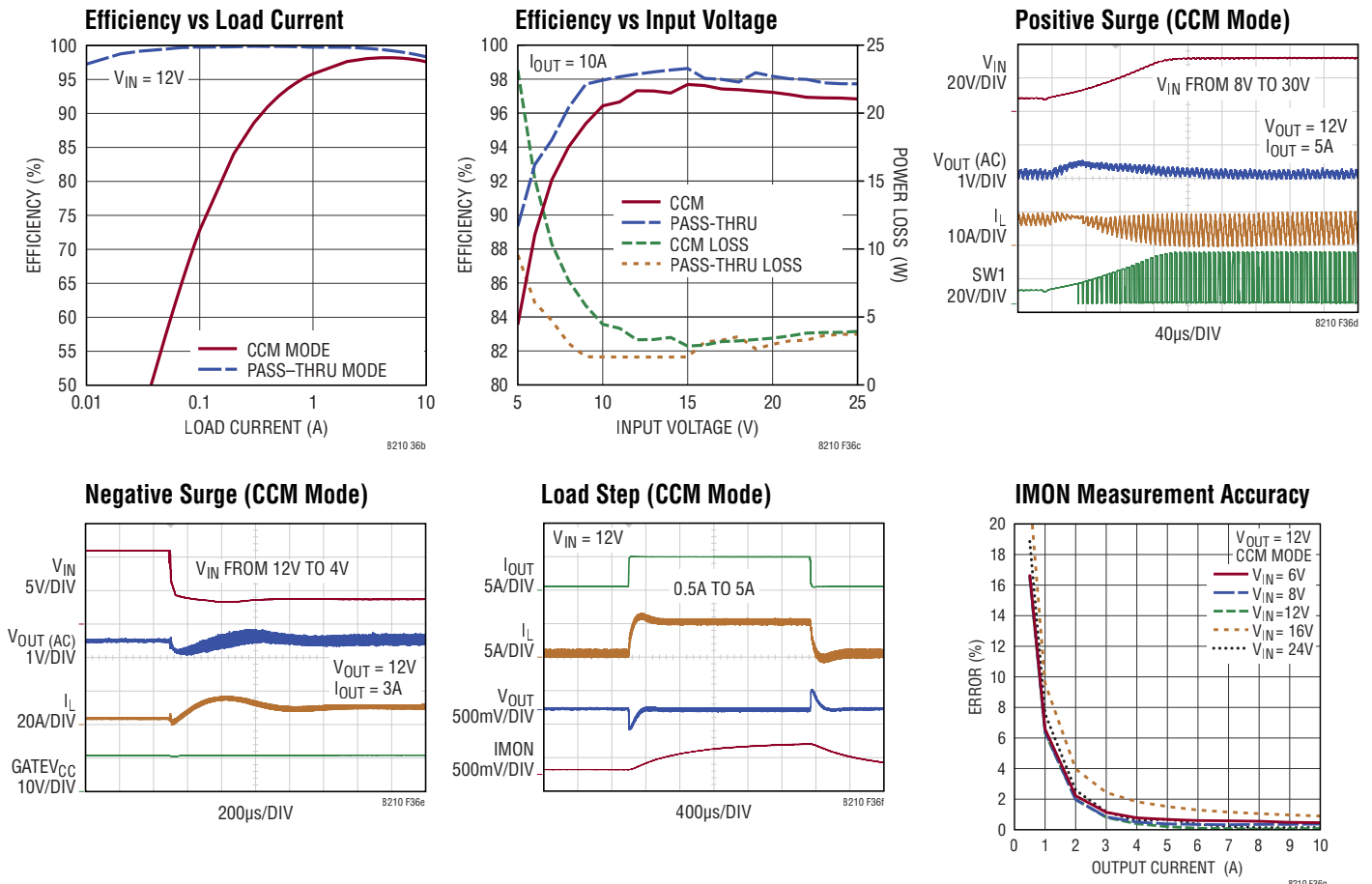

Figure 36. 10A, 12V Buck-Boost (CCM)/8V to 16V Pass-Thru Regulator



TYPICAL APPLICATIONS

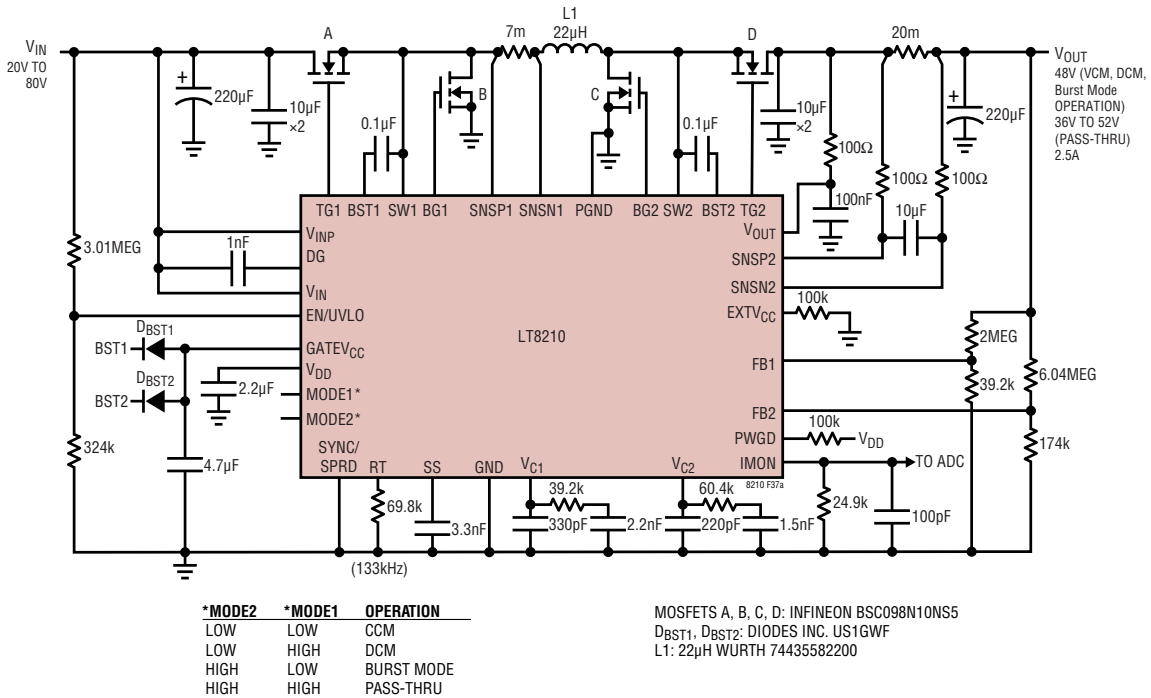
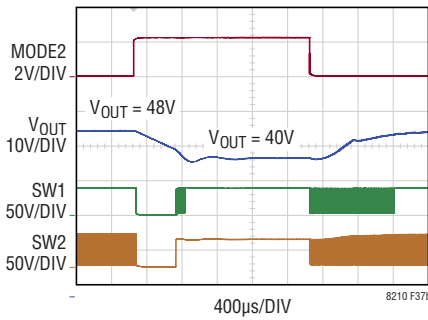
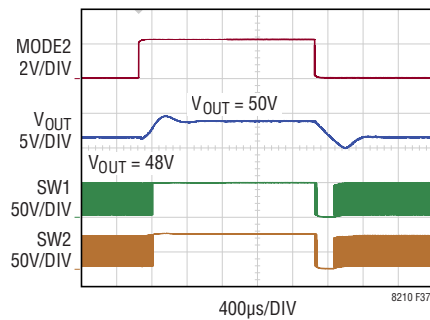

Figure 37. 2.5A, 48V Buck-Boost Regulator/36V to 52V Pass-Thru Regulator

DCM to Pass-Thru Mode Transition (VIN = 40V)



DCM to Pass-Thru Mode Transition (VIN = 50V)



Pass-Thru Positive Surge (Rising Edge)

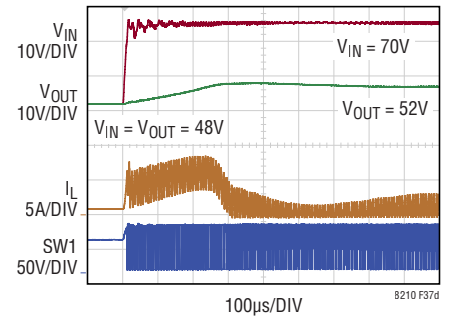

Pass-Thru Positive Surge (Falling Edge)

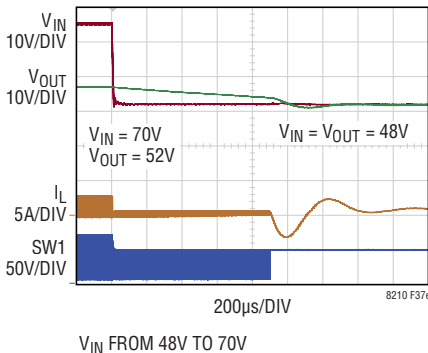

VIN FROM 48V TO 70V

Pass-Thru Negative Surge (Falling Edge)

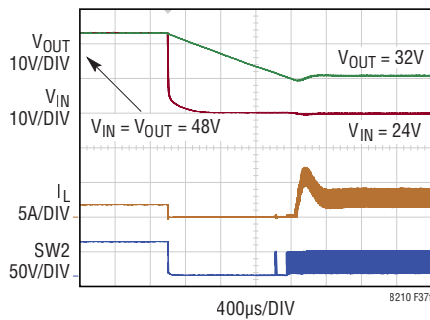

Pass-Thru No Load Input Current

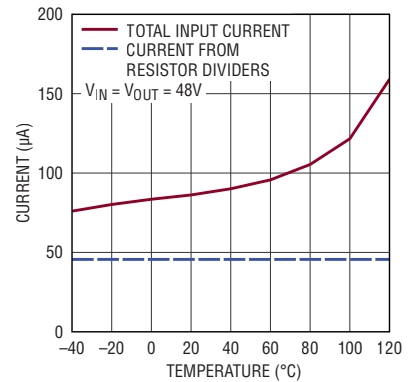

8210 F37g

Rev. B

TYPICAL APPLICATIONS

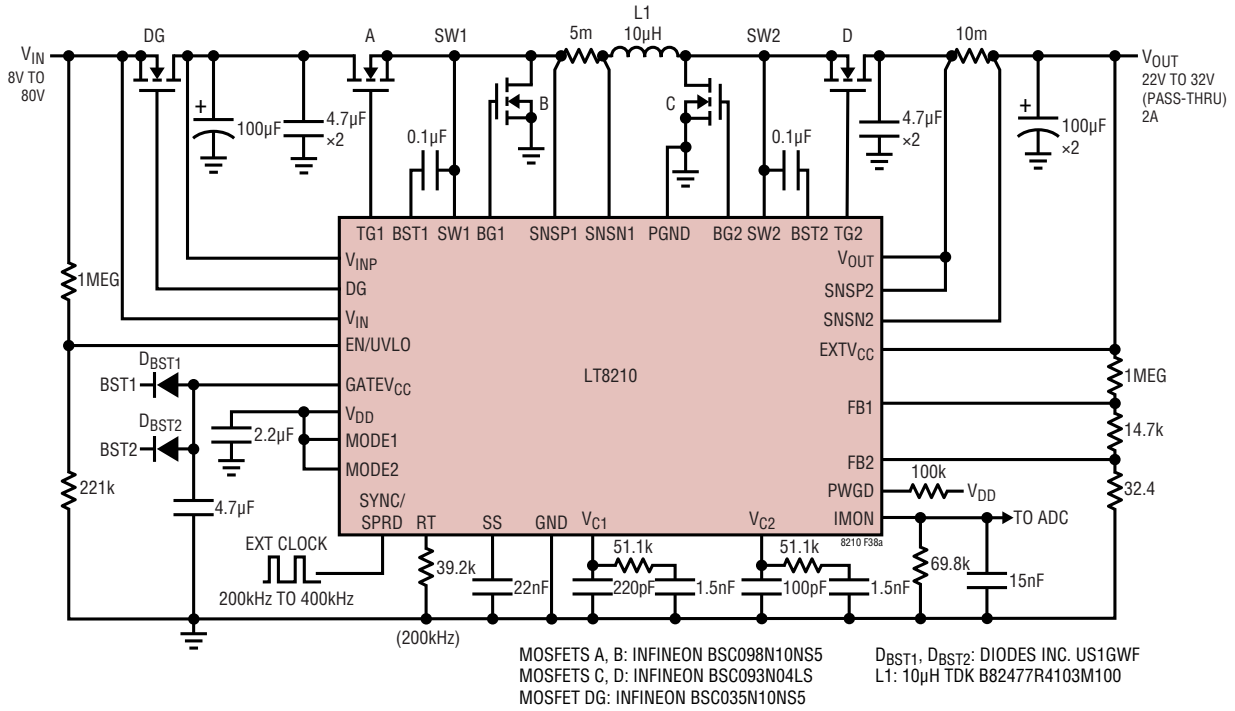
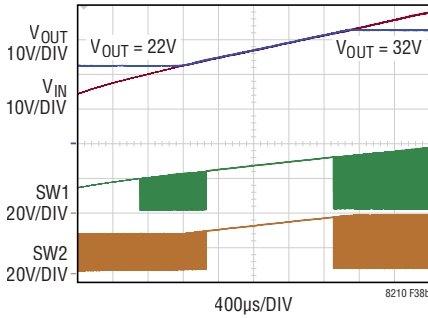
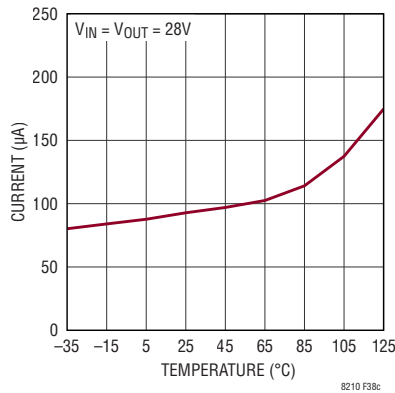

Figure 38. 2A, 22V to 32V Pass-Thru Regulator for Noise Sensitive Applications

Input Voltage Sweep



Pass-Thru No Load Input Current



Efficiency vs Input Voltage

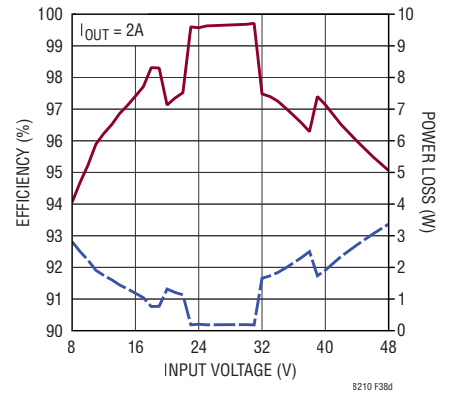

IMON Measurement Accuracy

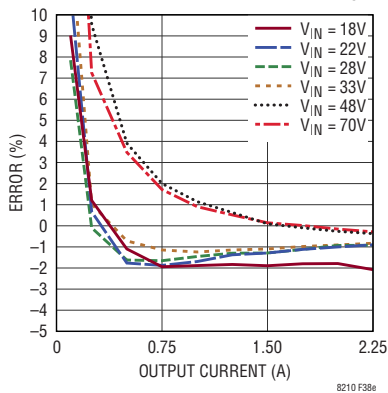

IMON Programmed Output Current Limit

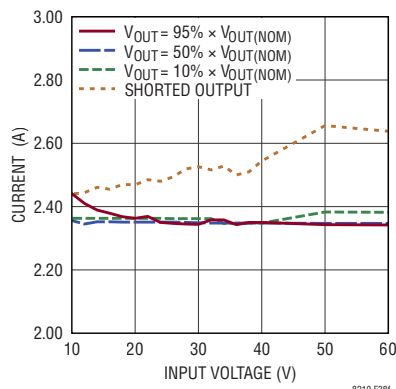

Output Short Circuit

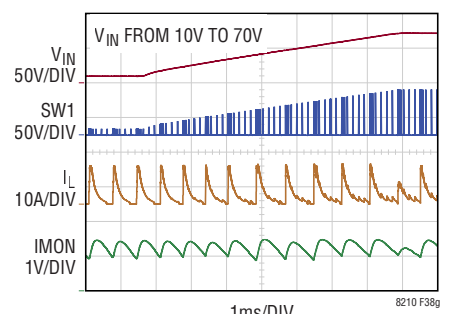

TYPICAL APPLICATIONS

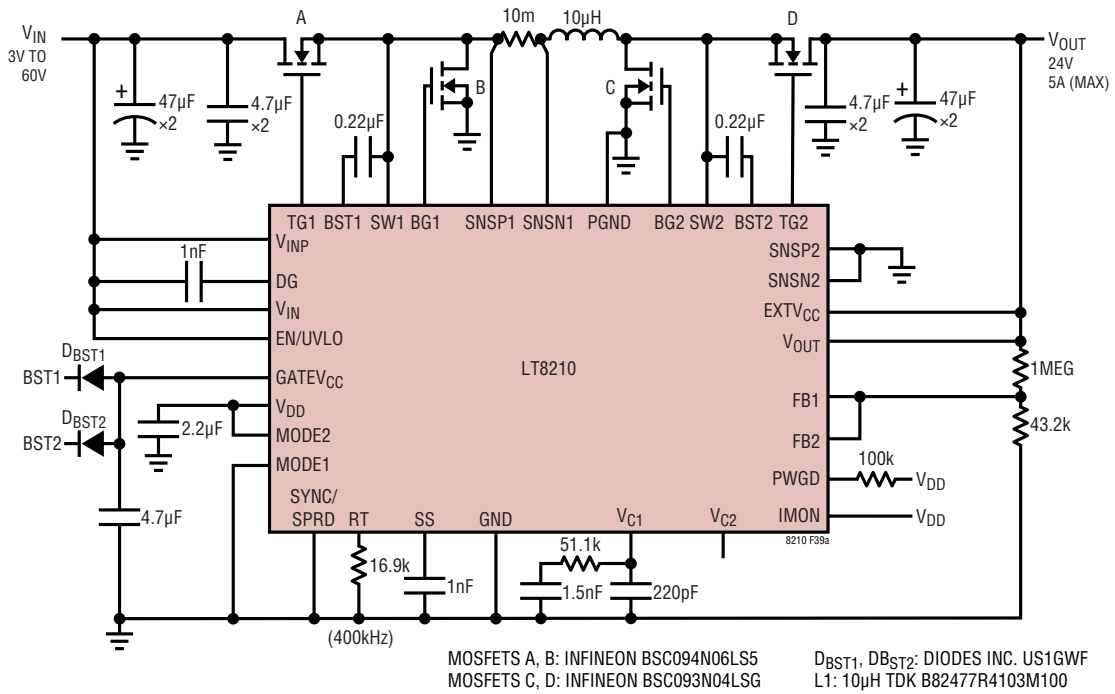
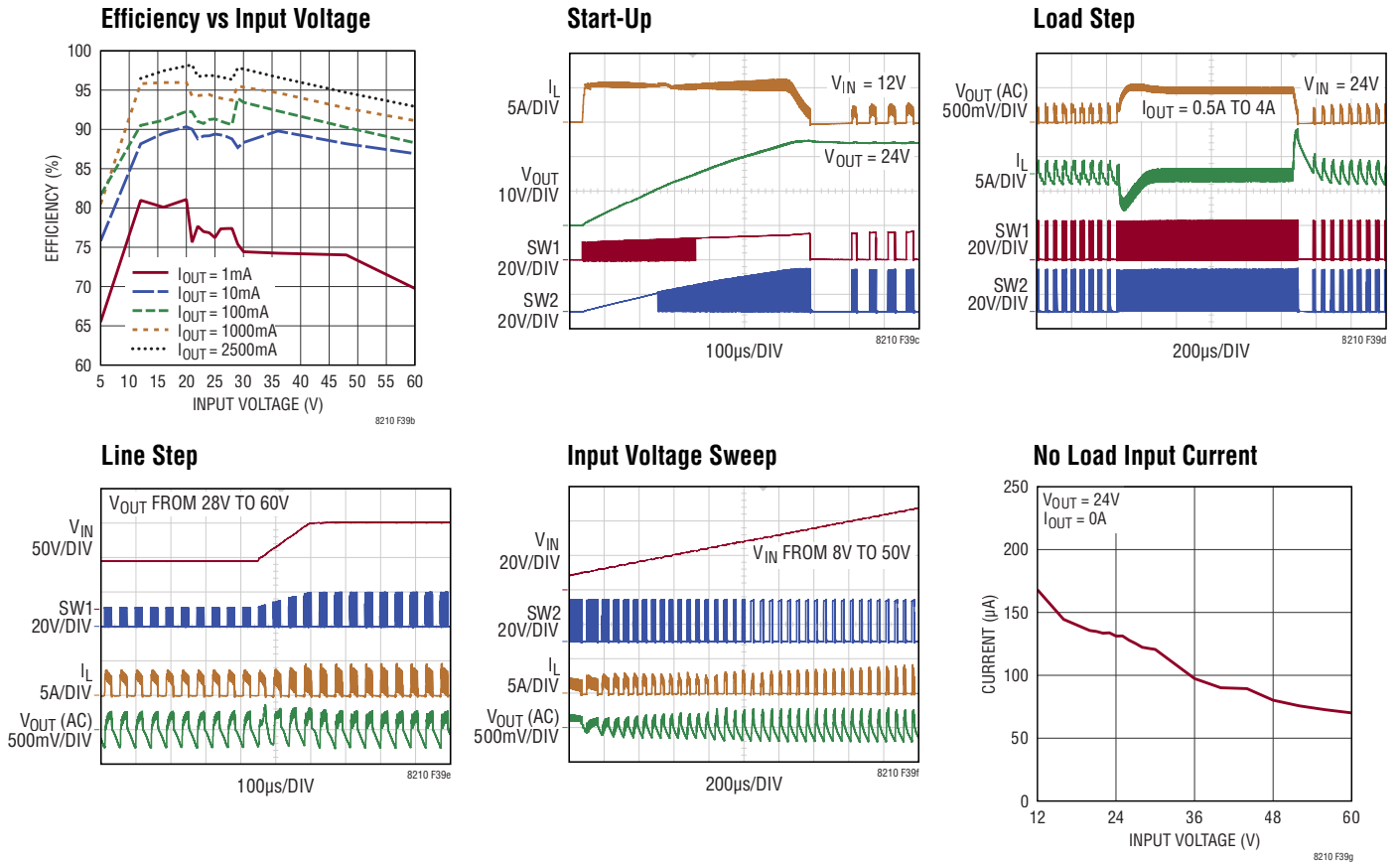
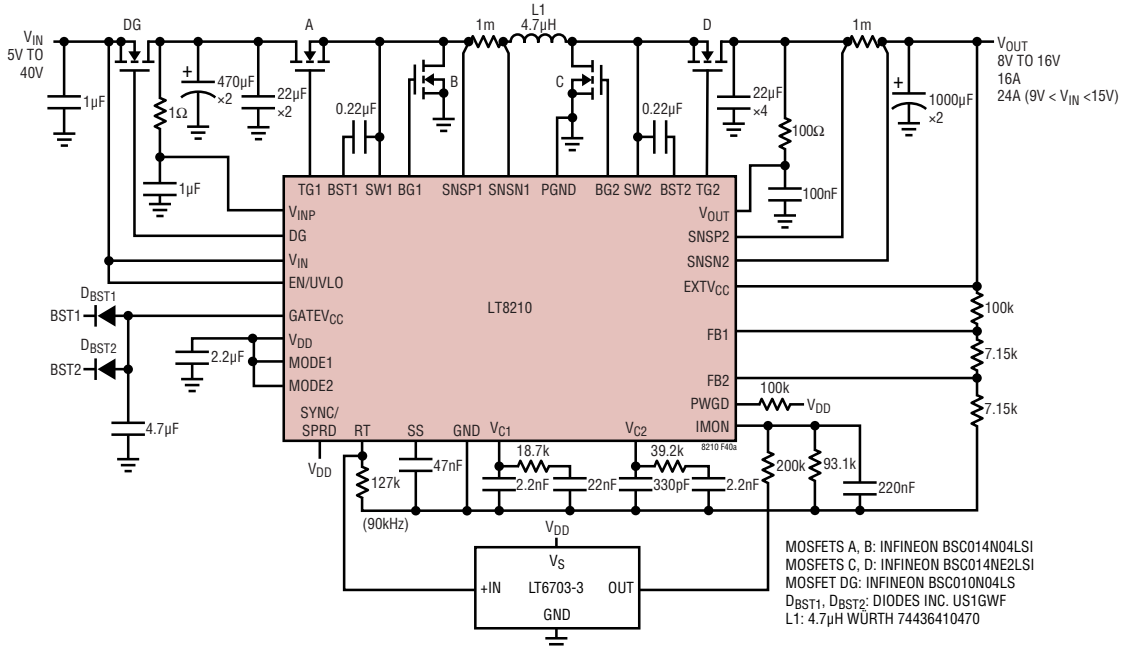

Figure 39. 24V Buck-Boost Regulator in Burst Mode Operation



TYPICAL APPLICATIONS



While switching the RT pin voltage is regulated to 800mV and the open-drain output of the LT6703-3 is high impedance. This causes the IMON resistance to be 93.1k, setting the average current limit to 18A. In the pass-thru non-switching state the RT pin is pulled to GND causing the output of the LT6703-3 to pull low and making the effective IMON resistor 63.5k, thereby increasing the average current limit to 25A. In the non-switching state much higher output current can be tolerated because of the lack of switching losses. The 220nF capacitor on the IMON pin acts as a timer that delays the transition from the 18A to 25A output current limit by roughly 20ms when the LT8210 transitions from the nonswitching to switching.

Figure 40. 24A/16A, 8V to 16V Pass-Thru Regulator

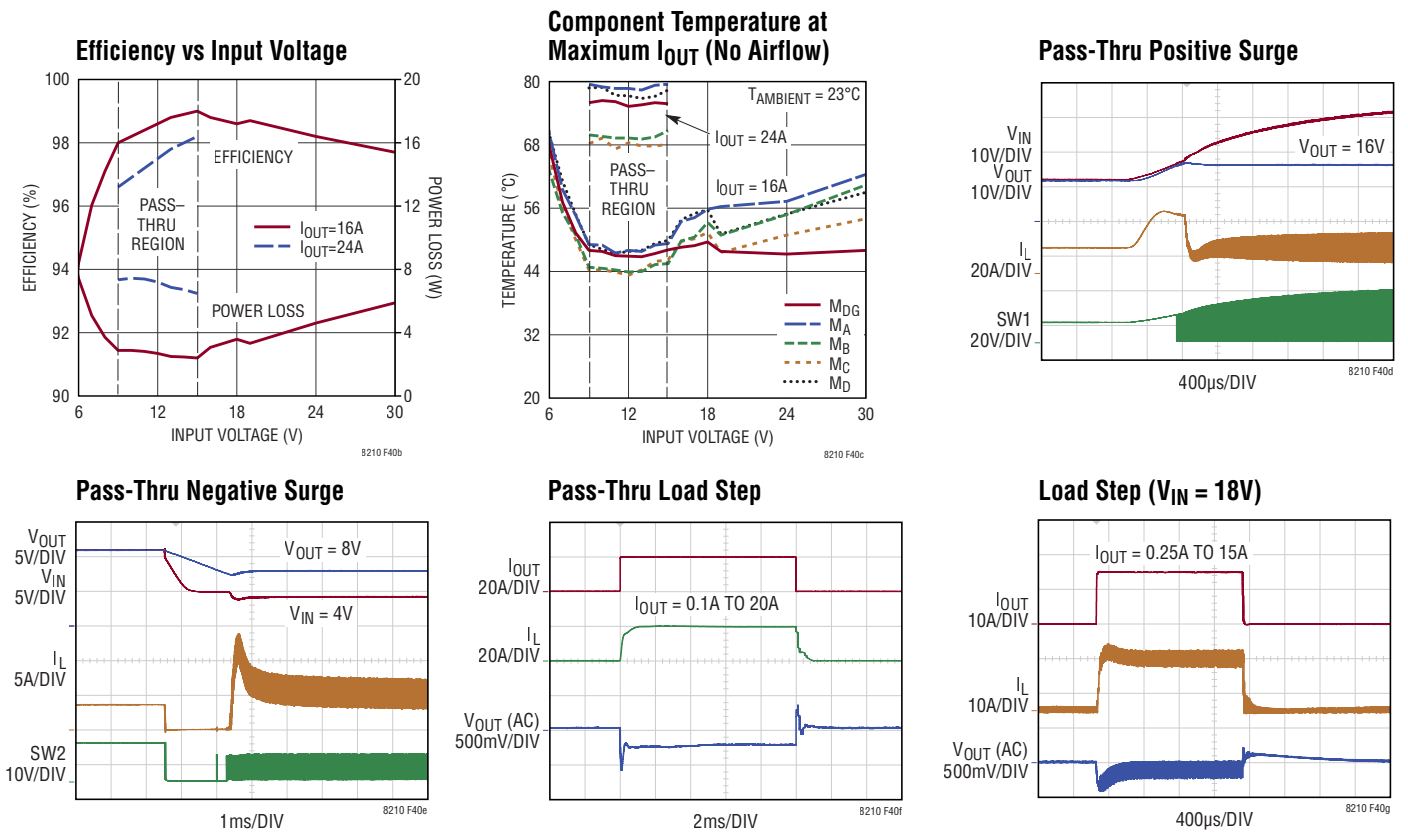

PACKAGE DESCRIPTION

FE Package
38-Lead Plastic TSSOP (4.4mm)
 (Reference LTC DWG # 05-08-1772 Rev C)
Exposed Pad Variation AA

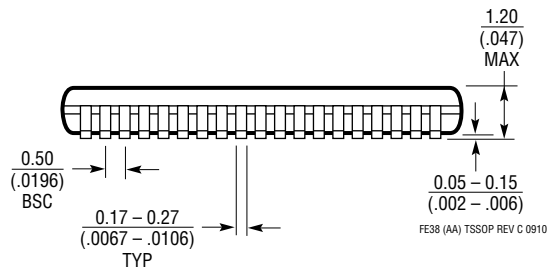
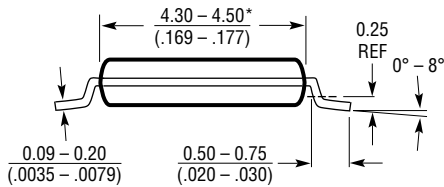
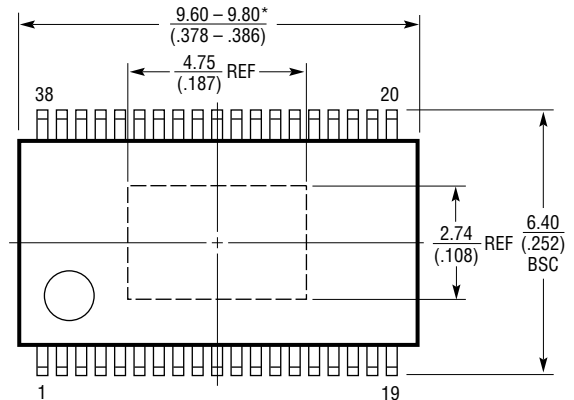
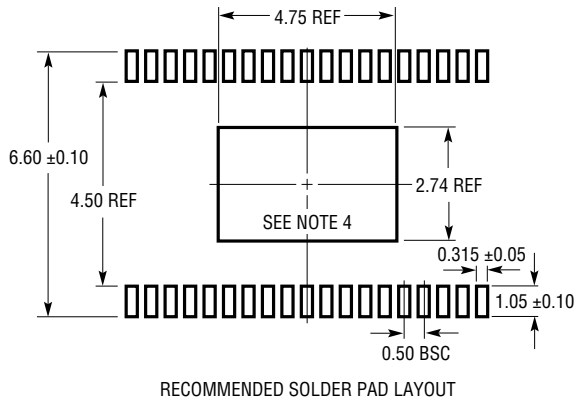

- NOTE:
1. CONTROLLING DIMENSION: MILLIMETERS
 2. DIMENSIONS ARE IN MILLIMETERS (INCHES)
 3. DRAWING NOT TO SCALE
 4. RECOMMENDED MINIMUM PCB METAL SIZE FOR EXPOSED PAD ATTACHMENT
 *DIMENSIONS DO NOT INCLUDE MOLD FLASH. MOLD FLASH SHALL NOT EXCEED 0.150mm (.006") PER SIDE

PACKAGE DESCRIPTION

UJ Package
40-Lead Plastic QFN (6mm × 6mm)
 (Reference LTC DWG # 05-08-1728 Rev 0)

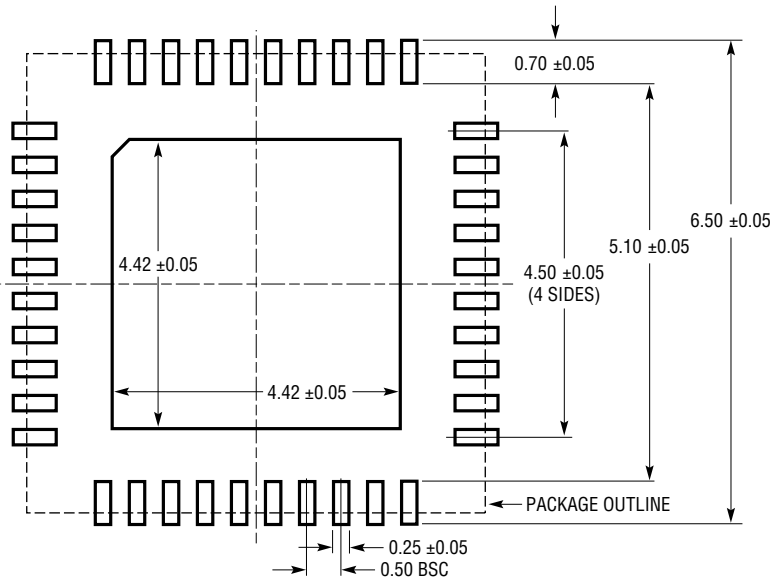

RECOMMENDED SOLDER PAD PITCH AND DIMENSIONS
 APPLY SOLDER MASK TO AREAS THAT ARE NOT SOLDERED

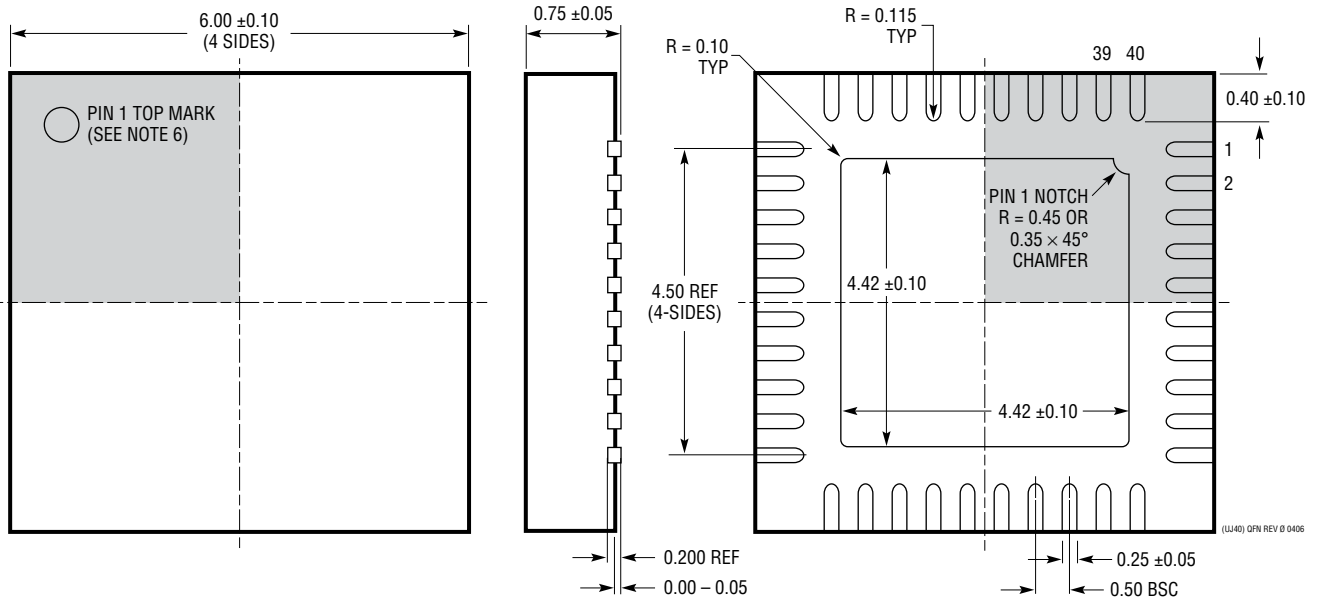

- NOTE:
1. DRAWING IS A JEDEC PACKAGE OUTLINE VARIATION OF (WJJD-2)
 2. DRAWING NOT TO SCALE
 3. ALL DIMENSIONS ARE IN MILLIMETERS
 4. DIMENSIONS OF EXPOSED PAD ON BOTTOM OF PACKAGE DO NOT INCLUDE MOLD FLASH. MOLD FLASH, IF PRESENT, SHALL NOT EXCEED 0.20mm ON ANY SIDE, IF PRESENT
 5. EXPOSED PAD SHALL BE SOLDER PLATED
 6. SHADED AREA IS ONLY A REFERENCE FOR PIN 1 LOCATION ON THE TOP AND BOTTOM OF PACKAGE

BOTTOM VIEW—EXPOSED PAD

(UJ40) QFN REV 0 0406

REVISION HISTORY

REV	DATE	DESCRIPTION	PAGE NUMBER
A	09/19	Added QFN Package and changed Pass-Through to Pass-Thru	1, 3, 12, 13, 44
B	02/20	Corrected QFN Pin 30 Name/Minor Typo's	2, 3, 4, 5, 6, 19, 27, 32, 34

TYPICAL APPLICATION

Low Quiescent Current Battery Backup Power Supply Utilizing Pass-Thru Mode

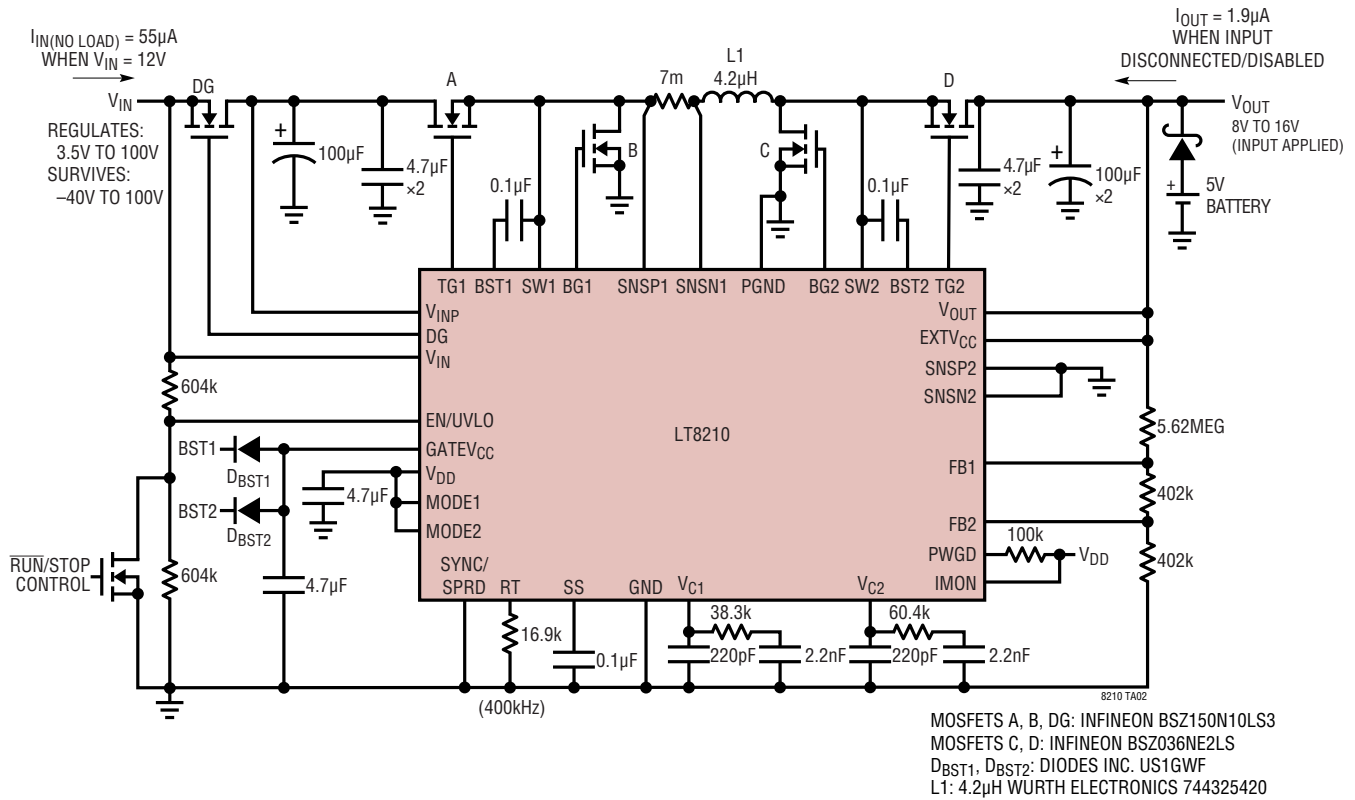

RELATED PARTS

PART NUMBER	DESCRIPTION	COMMENTS
LTC3779	150V V_{IN} and V_{OUT} Synchronous 4-Switch Buck-Boost Controller	$4.5V \leq V_{IN} \leq 150V$, $1.2V \leq V_{OUT} \leq 150V$, Up to 99% Efficiency Drives Logic Level or STD Threshold MOSFETS, TSSOP-38
LTC®3777	150V V_{IN} and V_{OUT} Synchronous 4-Switch Buck-Boost Controller + Switching Bias Supply	$4.5V \leq V_{IN} \leq 150V$, $1.2V \leq V_{OUT} \leq 150V$, Up to 99% Efficiency Drives Logic Level or STD Threshold MOSFETS, TSSOP-38
LT8705A	80V V_{IN} and V_{OUT} Synchronous 4-Switch Buck-Boost DC/DC Controller	$2.8V \leq V_{IN} \leq 80V$, Input and Output Current Monitor, 5mm × 7mm QFN-28/TSSOP-38
LTC7813	60V Low I_Q Synchronous Boost + Buck Controller Low EMI and Low Input/Output Ripple	$4.5V$ (Down to 2.2V After Start-Up) $\leq V_{IN} \leq 60V$, Boost V_{OUT} Up to 60V, $0.8V < \text{Buck } V_{OUT} < 60V$, $I_Q = 29\mu A$, 5mm × 5mm QFN-32
LT8390A	High Efficiency Synchronous 4-Switch Buck-Boost Controller	$4V \leq V_{IN} \leq 60V$, V_{OUT} Range: 1V to 60V, ±1.5% Output Voltage Accuracy 4mm × 5mm QFN-2/TSSOP-28 Packages
LTM®8056	58V Buck-Boost DC/DC µModule® Regulator, Adjustable Input and Output Current Limiting	$5V \leq V_{IN} \leq 58V$, $1.2V \leq V_{OUT} \leq 48V$ 15mm × 15mm × 4.92mm BGA Package
LTC3895/LTC7801	150V Low I_Q , Synchronous Step-Down DC/DC Controller with 100% Duty Cycle	$4V \leq V_{IN} \leq 140V$, 150V Abs Max, PLL Fixed Frequency 50kHz to 900kHz, $0.8V \leq V_{OUT} \leq 60V$, Adjustable 5V to 10V Gate Drive, $I_Q = 40\mu A$ 4mm × 5mm QFN-24/TSSOP-24/TSSOP-38(31)
LTC7103	105V, 2.3A Low EMI Synchronous Step-Down Regulator	$4.4V \leq V_{IN} \leq 105V$, $1V \leq V_{OUT} \leq V_{IN}$, $I_Q = 2\mu A$ Fixed Frequency 200kHz to 2MHz, 5mm × 6mm QFN

Данный компонент на территории Российской Федерации

Вы можете приобрести в компании MosChip.

Для оперативного оформления запроса Вам необходимо перейти по данной ссылке:

<http://moschip.ru/get-element>

Вы можете разместить у нас заказ для любого Вашего проекта, будь то серийное производство или разработка единичного прибора.

В нашем ассортименте представлены ведущие мировые производители активных и пассивных электронных компонентов.

Нашей специализацией является поставка электронной компонентной базы двойного назначения, продукции таких производителей как XILINX, Intel (ex.ALTERA), Vicor, Microchip, Texas Instruments, Analog Devices, Mini-Circuits, Amphenol, Glenair.

Сотрудничество с глобальными дистрибьюторами электронных компонентов, предоставляет возможность заказывать и получать с международных складов практически любой перечень компонентов в оптимальные для Вас сроки.

На всех этапах разработки и производства наши партнеры могут получить квалифицированную поддержку опытных инженеров.

Система менеджмента качества компании отвечает требованиям в соответствии с ГОСТ Р ИСО 9001, ГОСТ РВ 0015-002 и ЭС РД 009

Офис по работе с юридическими лицами:

105318, г.Москва, ул.Щербаковская д.3, офис 1107, 1118, ДЦ «Щербаковский»

Телефон: +7 495 668-12-70 (многоканальный)

Факс: +7 495 668-12-70 (доб.304)

E-mail: info@moschip.ru

Skype отдела продаж:

moschip.ru

moschip.ru_4

moschip.ru_6

moschip.ru_9