

DATASHEET

UF3C065030B3

650V-27mΩ SiC Cascode

Rev. A, March 2019

Description

United Silicon Carbide's cascode products co-package its high-performance G3 SiC JFETs with a cascode optimized MOSFET to produce the only standard gate drive SiC device in the market today. This series exhibits ultra-low gate charge, but also the best reverse recovery characteristics of any device of similar ratings. These devices are excellent for switching inductive loads when used with recommended RC-snubbers, and any application requiring standard gate drive.

Features

- ◆ Typical on-resistance $R_{DS(on),typ}$ of 27mΩ
- ◆ Maximum operating temperature of 175°C
- ◆ Excellent reverse recovery
- ◆ Low gate charge
- ◆ Low intrinsic capacitance
- ◆ ESD protected, HBM class 2
- ◆ Very low switching losses (required RC-snubber loss negligible under typical operating conditions)

Typical applications

- ◆ EV charging
- ◆ PV inverters
- ◆ Switch mode power supplies
- ◆ Power factor correction modules
- ◆ Motor drives
- ◆ Induction heating

TAB

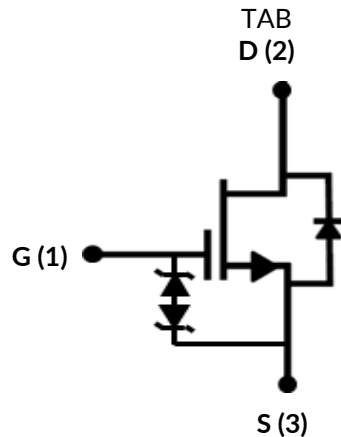

Part Number	Package	Marking
UF3C065030B3	D ² PAK-3L	UF3C065030B3



Maximum Ratings

Parameter	Symbol	Test Conditions	Value	Units
Drain-source voltage	V_{DS}		650	V
Gate-source voltage	V_{GS}	DC	-25 to +25	V
Continuous drain current ¹	I_D	$T_C = 25^\circ\text{C}$	65	A
		$T_C = 100^\circ\text{C}$	47	A
Pulsed drain current ²	I_{DM}	$T_C = 25^\circ\text{C}$	230	A
Single pulsed avalanche energy ³	E_{AS}	$L=15\text{mH}, I_{AS}=4\text{A}$	120	mJ
Power dissipation	P_{tot}	$T_C = 25^\circ\text{C}$	242	W
Maximum junction temperature	$T_{J,max}$		175	$^\circ\text{C}$
Operating and storage temperature	T_J, T_{STG}		-55 to 175	$^\circ\text{C}$
Max. lead temperature for soldering, 1/8" from case for 5 seconds	T_L		250	$^\circ\text{C}$

1. Limited by $T_{J,max}$

2. Pulse width t_p limited by $T_{J,max}$

3. Starting $T_J = 25^\circ\text{C}$

Thermal Characteristics

Parameter	Symbol	Test Conditions	Value			Units
			Min	Typ	Max	
Thermal resistance, junction-to-case	$R_{\theta JC}$			0.48	0.62	$^\circ\text{C}/\text{W}$

Electrical Characteristics ($T_J = +25^\circ\text{C}$ unless otherwise specified)

Typical Performance - Static

Parameter	Symbol	Test Conditions	Value			Units
			Min	Typ	Max	
Drain-source breakdown voltage	BV_{DS}	$V_{GS}=0V, I_D=1mA$	650			V
Total drain leakage current	I_{DSS}	$V_{DS}=650V,$ $V_{GS}=0V, T_J=25^\circ\text{C}$		6	150	μA
		$V_{DS}=650V,$ $V_{GS}=0V, T_J=175^\circ\text{C}$		30		
Total gate leakage current	I_{GSS}	$V_{DS}=0V, T_J=25^\circ\text{C},$ $V_{GS}=-20V / +20V$		6	± 20	μA
Drain-source on-resistance	$R_{DS(on)}$	$V_{GS}=12V, I_D=40A,$ $T_J=25^\circ\text{C}$		27	35	m Ω
		$V_{GS}=12V, I_D=40A,$ $T_J=175^\circ\text{C}$		43		
Gate threshold voltage	$V_{G(th)}$	$V_{DS}=5V, I_D=10mA$	4	5	6	V
Gate resistance	R_G	f=1MHz, open drain		4.5		Ω

Typical Performance - Reverse Diode

Parameter	Symbol	Test Conditions	Value			Units
			Min	Typ	Max	
Diode continuous forward current ¹	I_S	$T_C=25^\circ\text{C}$			65	A
Diode pulse current ²	$I_{S,pulse}$	$T_C=25^\circ\text{C}$			230	A
Forward voltage	V_{FSD}	$V_{GS}=0V, I_F=20A,$ $T_J=25^\circ\text{C}$		1.3	1.4	V
		$V_{GS}=0V, I_F=20A,$ $T_J=175^\circ\text{C}$		1.35		
Reverse recovery charge	Q_{rr}	$V_R=400V, I_F=40A,$ $V_{GS}=-5V, R_{G,EXT}=22\Omega$ $di/dt=1500A/\mu\text{s},$ $T_J=25^\circ\text{C}$		211		nC
Reverse recovery time	t_{rr}	$T_J=25^\circ\text{C}$		34		ns
Reverse recovery charge	Q_{rr}	$V_R=400V, I_F=40A,$ $V_{GS}=-5V, R_{G,EXT}=22\Omega$ $di/dt=1500A/\mu\text{s},$ $T_J=150^\circ\text{C}$		188		nC
Reverse recovery time	t_{rr}	$T_J=150^\circ\text{C}$		32		ns

Typical Performance - Dynamic

Parameter	Symbol	Test Conditions	Value			Units	
			Min	Typ	Max		
Input capacitance	C_{iss}	$V_{DS}=100V, V_{GS}=0V$ $f=100kHz$		1500		pF	
Output capacitance	C_{oss}			293			
Reverse transfer capacitance	C_{rss}			2			
Effective output capacitance, energy related	$C_{oss(er)}$	$V_{DS}=0V$ to 400V, $V_{GS}=0V$		215		pF	
Effective output capacitance, time related	$C_{oss(tr)}$	$V_{DS}=0V$ to 400V, $V_{GS}=0V$		480		pF	
C_{OSS} stored energy	E_{oss}	$V_{DS}=400V, V_{GS}=0V$		17.5		μJ	
Total gate charge	Q_G	$V_{DS}=400V, I_D=40A,$ $V_{GS} = -5V$ to 15V		51		nC	
Gate-drain charge	Q_{GD}			11			
Gate-source charge	Q_{GS}			19			
Turn-on delay time	$t_{d(on)}$	$V_{DS}=400V, I_D=40A,$ Gate Driver = -5V to +15V, Turn-on $R_{G,EXT}=1.8\Omega,$ Turn-off $R_{G,EXT}=22\Omega$ Inductive Load, FWD: same device with $V_{GS} = -5V$ and $R_G = 22\Omega,$ RC snubber: $R_S=5\Omega$ and $C_S=330pF, T_J=25^\circ C$		34		ns	
Rise time	t_r			16			
Turn-off delay time	$t_{d(off)}$			56			
Fall time	t_f			15			
Turn-on energy including R_S energy ⁴	E_{ON}	$V_{DS}=400V, I_D=40A,$ Gate Driver = -5V to +15V, Turn-on $R_{G,EXT}=1.8\Omega,$ Turn-off $R_{G,EXT}=22\Omega$ Inductive Load, FWD: same device with $V_{GS} = -5V$ and $R_G = 22\Omega,$ RC snubber: $R_S=5\Omega$ and $C_S=330pF, T_J=25^\circ C$		392		μJ	
Turn-off energy including R_S energy ⁴	E_{OFF}			113			
Total switching energy including R_S energy ⁴	E_{TOTAL}			505			
Snubber R_S energy during turn-on	E_{RS_ON}			5.3			
Snubber R_S energy during turn-off	E_{RS_OFF}			7.9			
Turn-on delay time	$t_{d(on)}$		$V_{DS}=400V, I_D=40A,$ Gate Driver = -5V to +15V, Turn-on $R_{G,EXT}=1.8\Omega,$ Turn-off $R_{G,EXT}=22\Omega$ Inductive Load, FWD: same device with $V_{GS} = -5V$ and $R_G = 22\Omega,$ RC snubber: $R_S=5\Omega$ and $C_S=330pF, T_J=150^\circ C$		32		
Rise time	t_r				16		
Turn-off delay time	$t_{d(off)}$				57		
Fall time	t_f			16			
Turn-on energy including R_S energy ⁴	E_{ON}			370			
Turn-off energy including R_S energy ⁴	E_{OFF}			118			
Total switching energy including R_S energy ⁴	E_{TOTAL}			488			
Snubber R_S energy during turn-on	E_{RS_ON}			4.6			
Snubber R_S energy during turn-off	E_{RS_OFF}		8.2				

4. The switching performance are evaluated with a RC snubber circuit as shown in Figure 24.

Typical Performance Diagrams

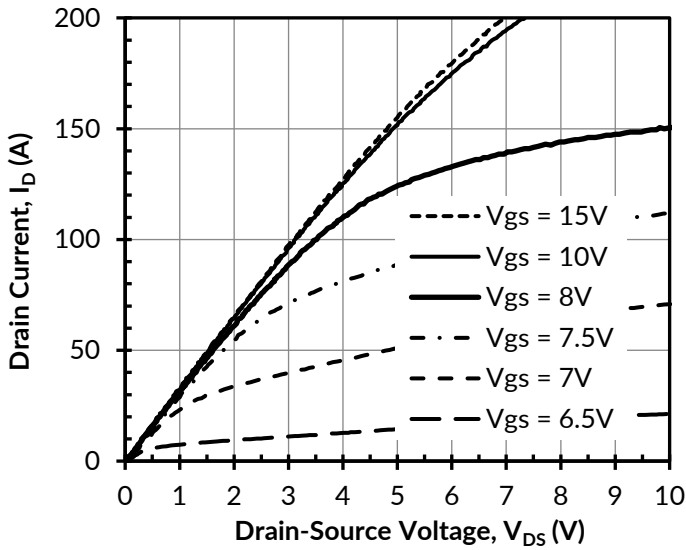

Figure 1. Typical output characteristics at $T_J = -55^\circ\text{C}$, $t_p < 250\mu\text{s}$

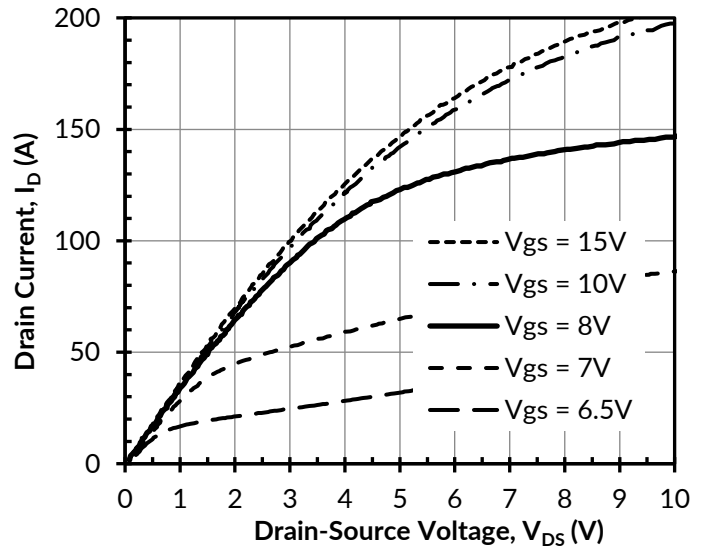

Figure 2. Typical output characteristics at $T_J = 25^\circ\text{C}$, $t_p < 250\mu\text{s}$

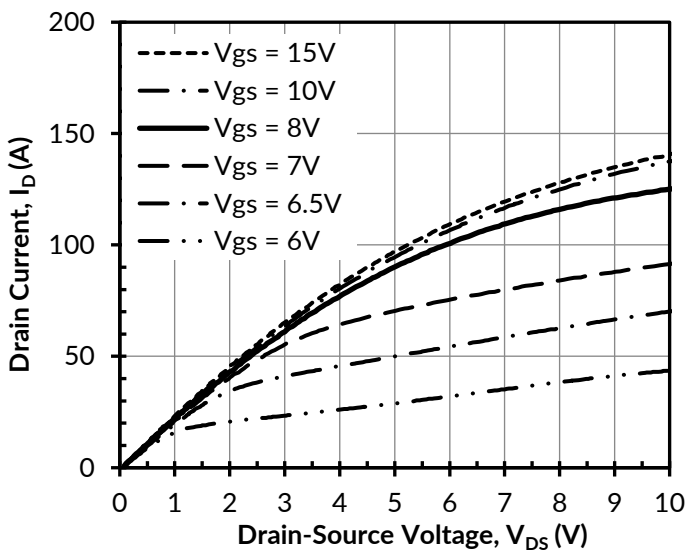

Figure 3. Typical output characteristics at $T_J = 175^\circ\text{C}$, $t_p < 250\mu\text{s}$

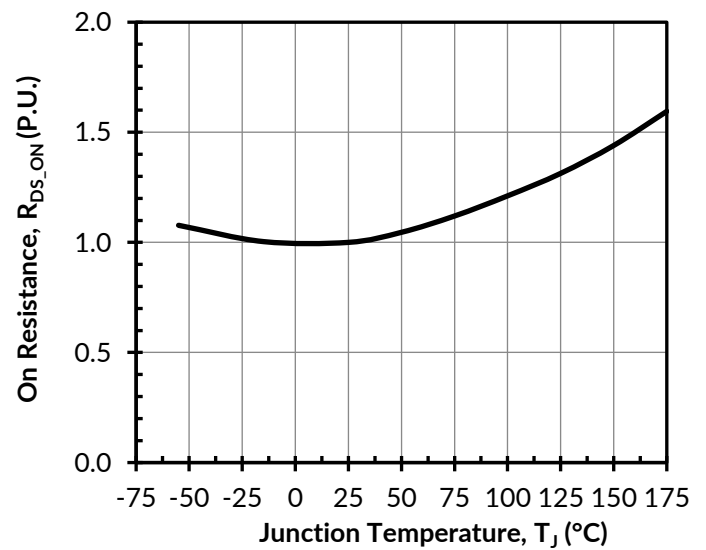

Figure 4. Normalized on-resistance vs. temperature at $V_{GS} = 12\text{V}$ and $I_D = 40\text{A}$

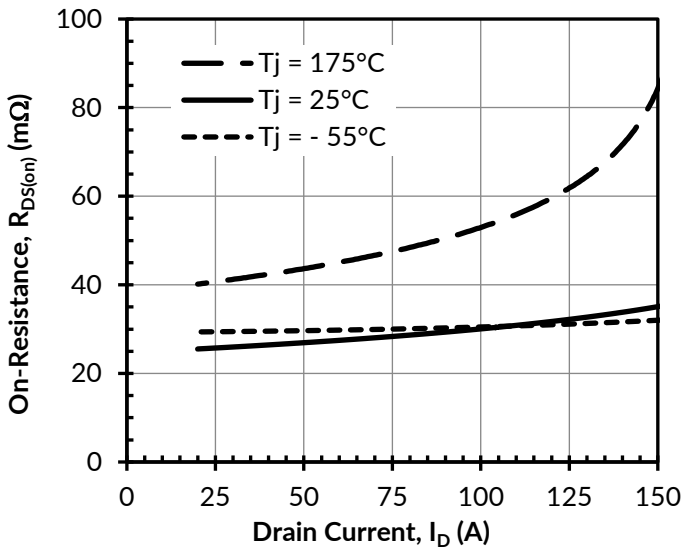

Figure 5. Typical drain-source on-resistances at $V_{GS} = 12\text{V}$

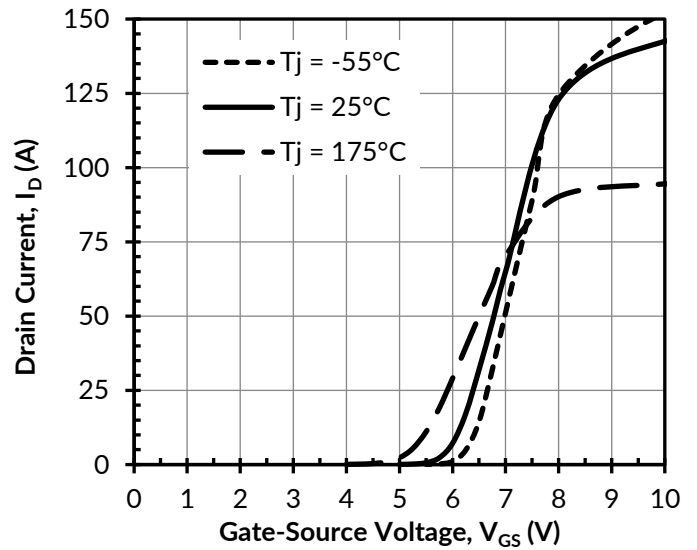

Figure 6. Typical transfer characteristics at $V_{DS} = 5\text{V}$

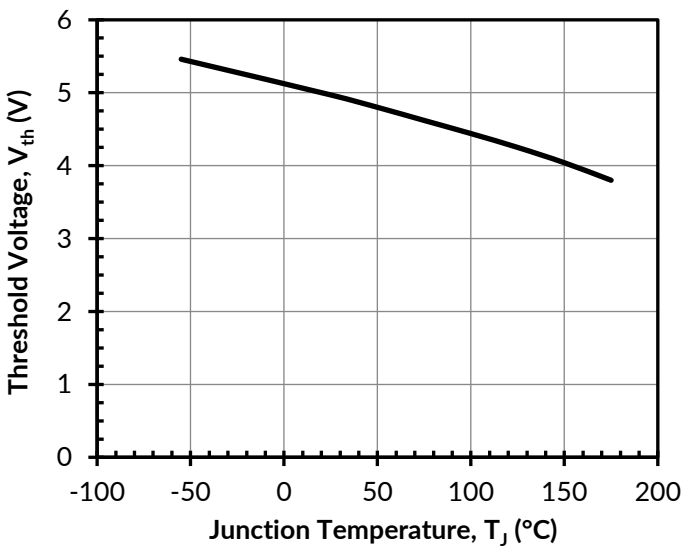

Figure 7. Threshold voltage vs. junction temperature at $V_{DS} = 5\text{V}$ and $I_D = 10\text{mA}$

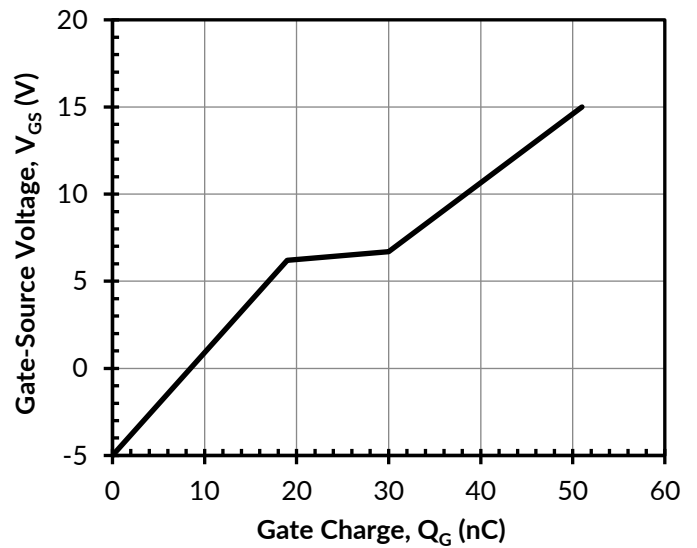

Figure 8. Typical gate charge at $V_{DS} = 400\text{V}$ and $I_D = 40\text{A}$

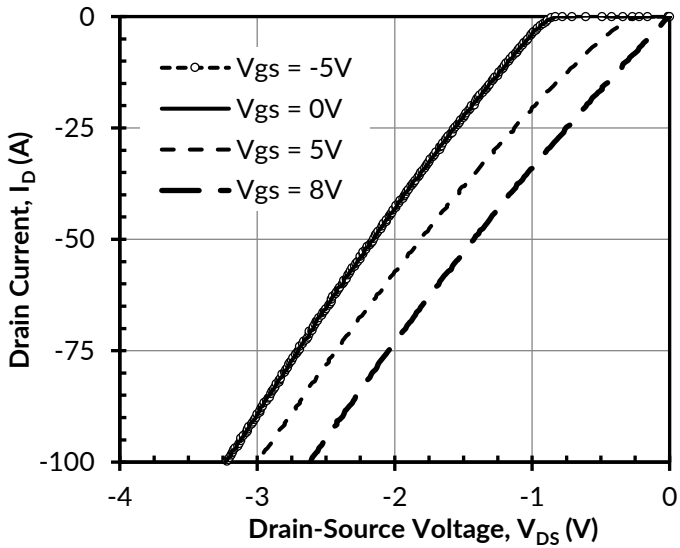

Figure 9. 3rd quadrant characteristics at $T_j = -55^\circ\text{C}$

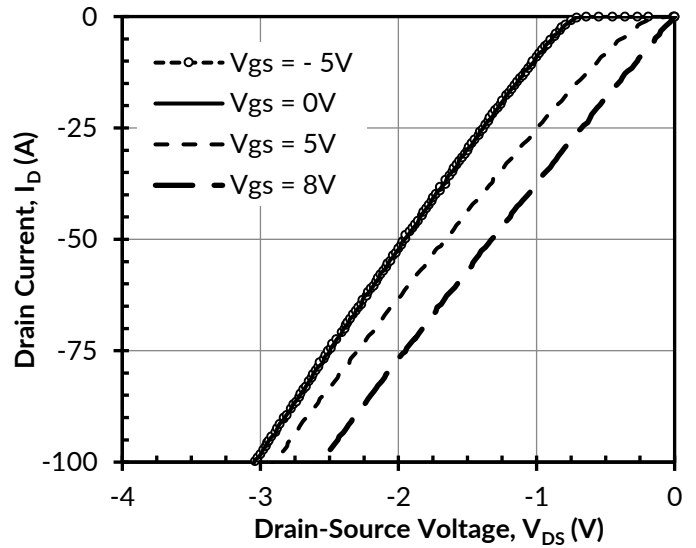

Figure 10. 3rd quadrant characteristics at $T_j = 25^\circ\text{C}$

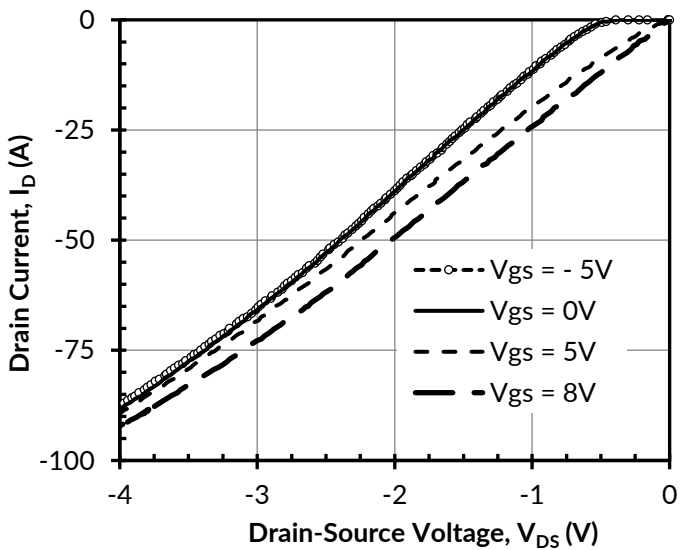

Figure 11. 3rd quadrant characteristics at $T_j = 175^\circ\text{C}$

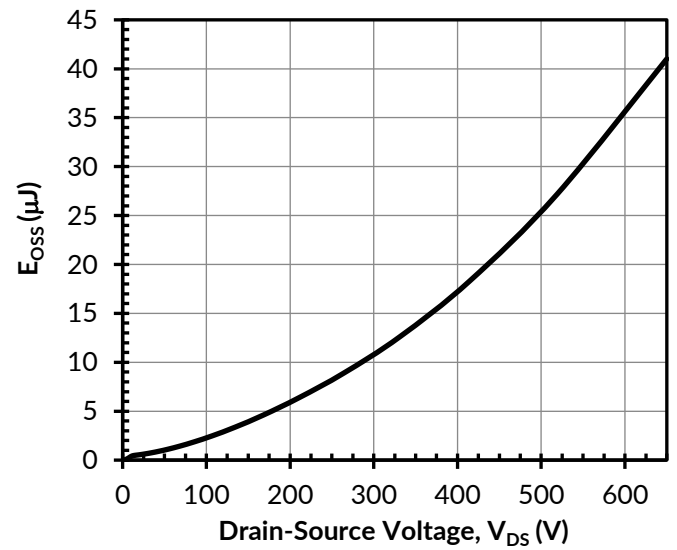

Figure 12. Typical stored energy in C_{OSS} at $V_{GS} = 0\text{V}$

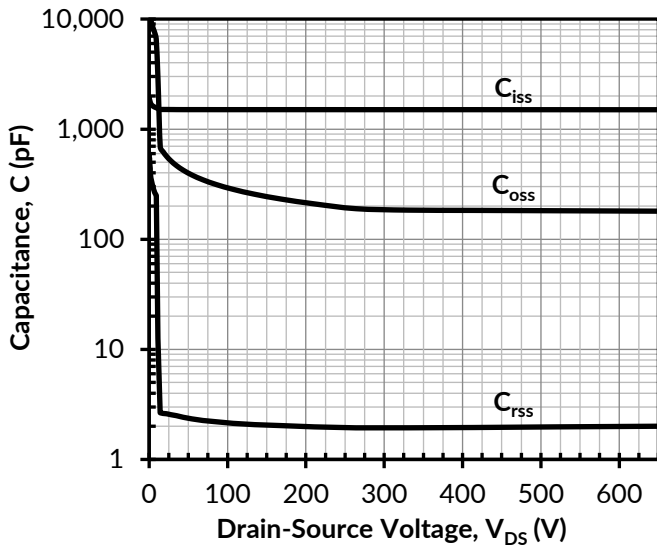

Figure 13. Typical capacitances at $f = 100\text{kHz}$ and $V_{GS} = 0\text{V}$

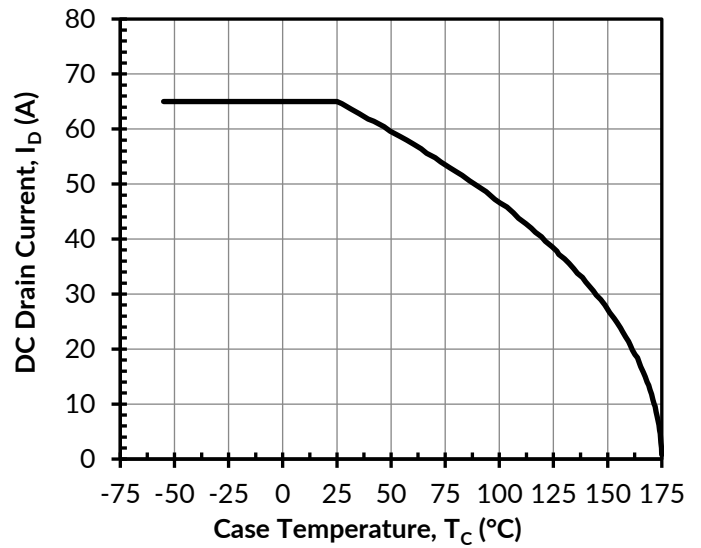

Figure 14. DC drain current derating

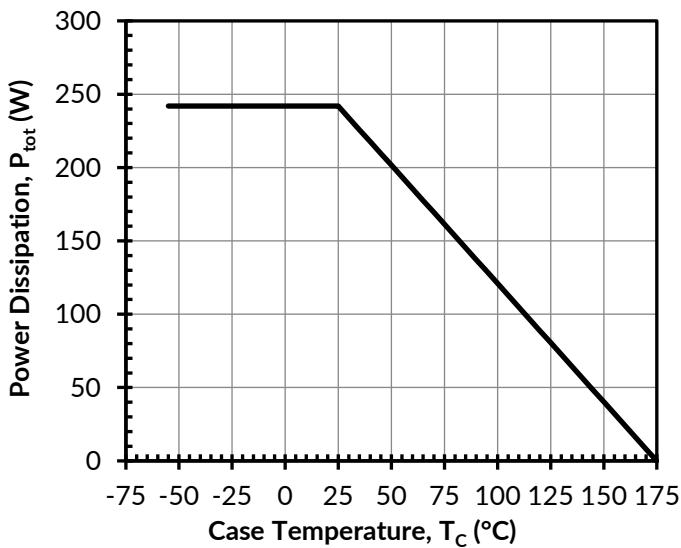

Figure 15. Total power dissipation

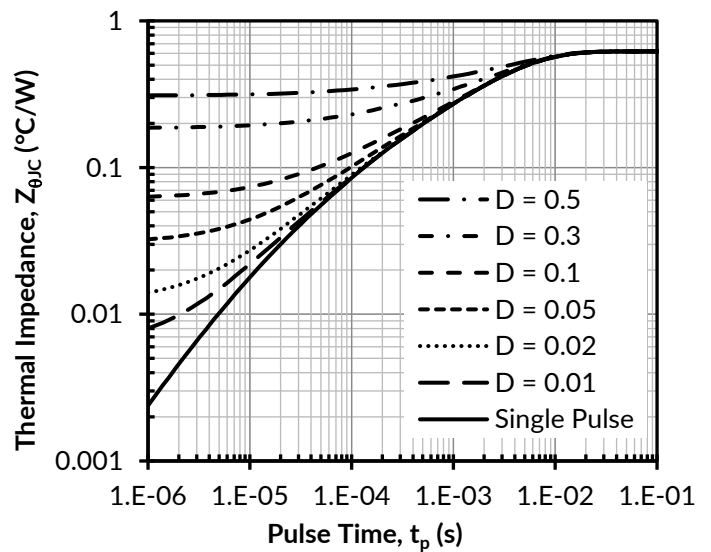

Figure 16. Maximum transient thermal impedance

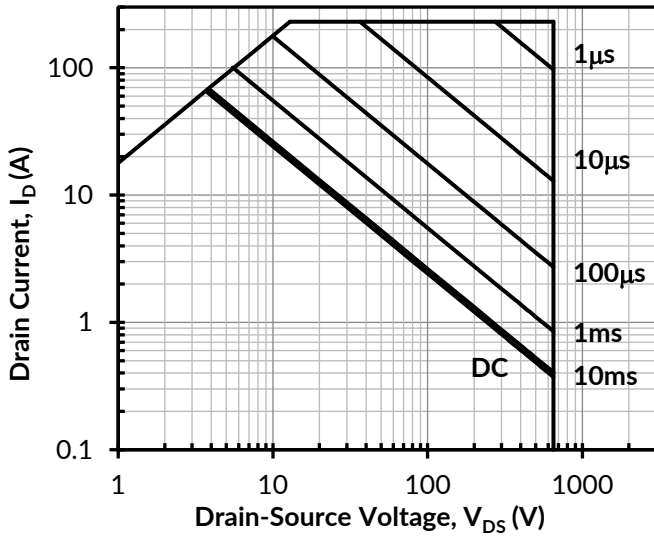

Figure 17. Safe operation area at $T_C = 25^\circ\text{C}$, $D = 0$, Parameter t_p

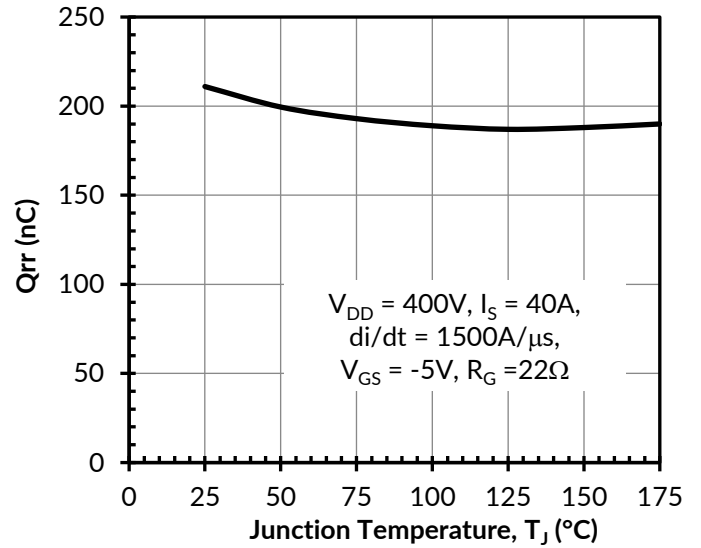
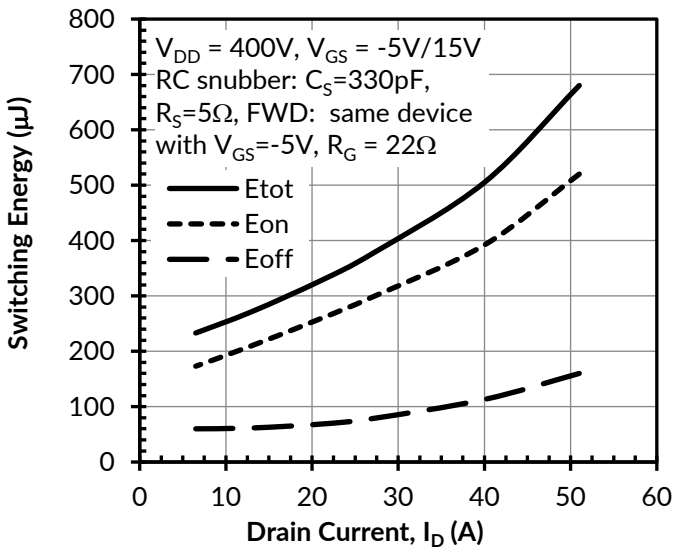
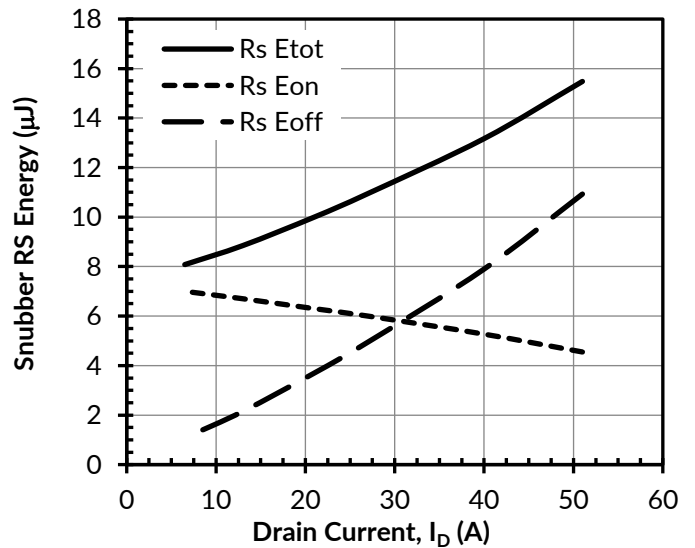

Figure 18. Reverse recovery charge Q_{rr} vs. junction temperature



(a)



(b)

Figure 19. Clamped inductive switching energy (a) and RC snubber energy loss (b) vs. drain current at $T_J = 25^\circ\text{C}$, turn-on $R_{G_EXT} = 1.8\Omega$, and turn-off $R_{G_EXT} = 22\Omega$

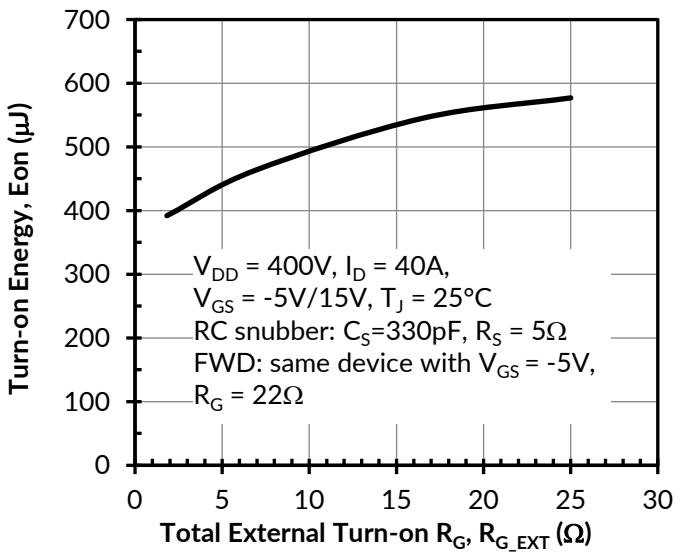

(a)

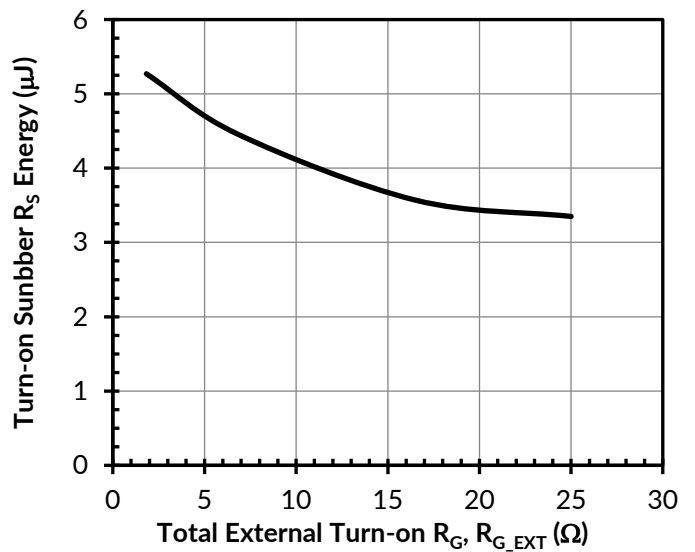

(b)

Figure 20. Clamped inductive switching turn-on energy including RC snubber energy loss (a) and RC snubber energy loss (b) as a function of total external turn-on gate resistor R_{G_EXT}

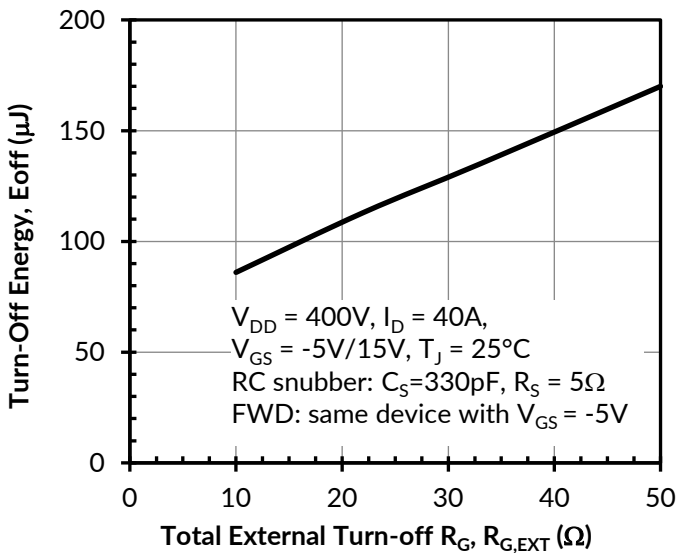

(a)

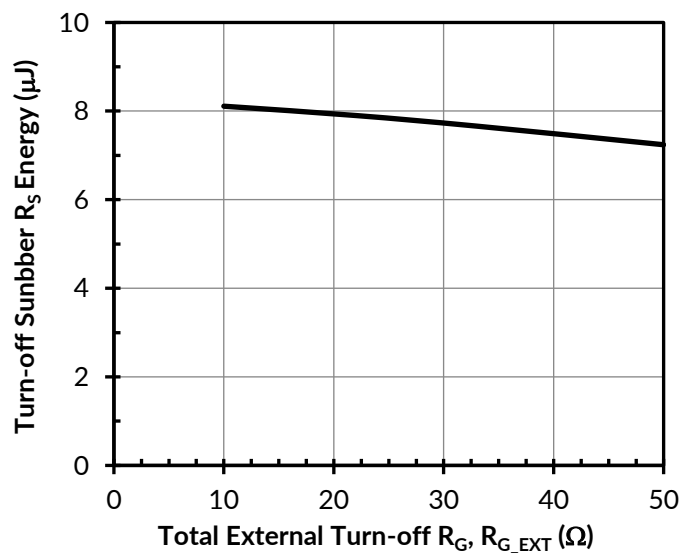

(b)

Figure 21. Clamped inductive switching turn-off energy including RC snubber energy loss (a) and RC snubber energy loss (b) as a function of total external turn-off gate resistor R_{G_EXT}

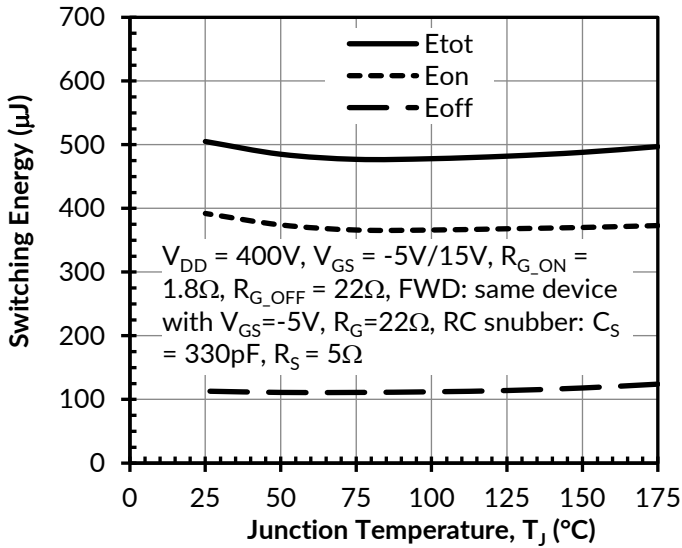

(a)

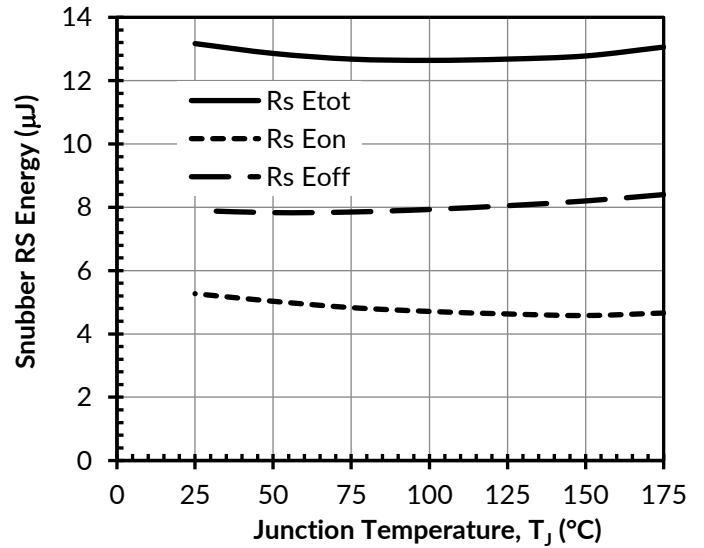

(b)

Figure 22. Clamped inductive switching energy including RC snubber energy loss (a) and RC snubber energy loss (b) as a function of junction temperature at $I_D = 40A$

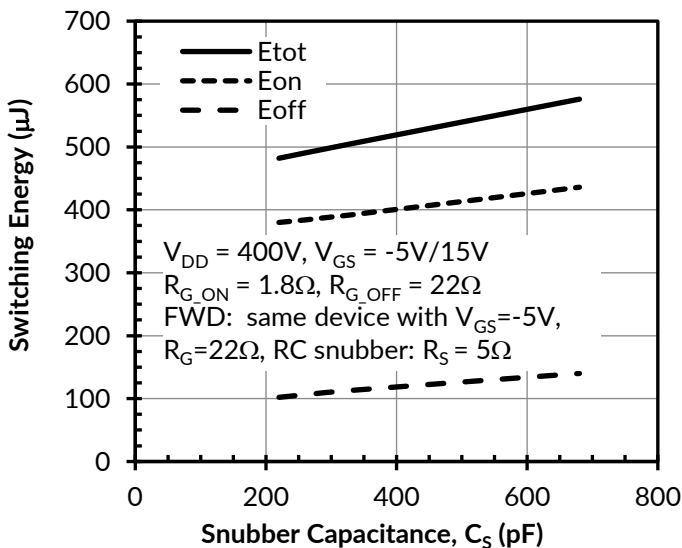

(a)

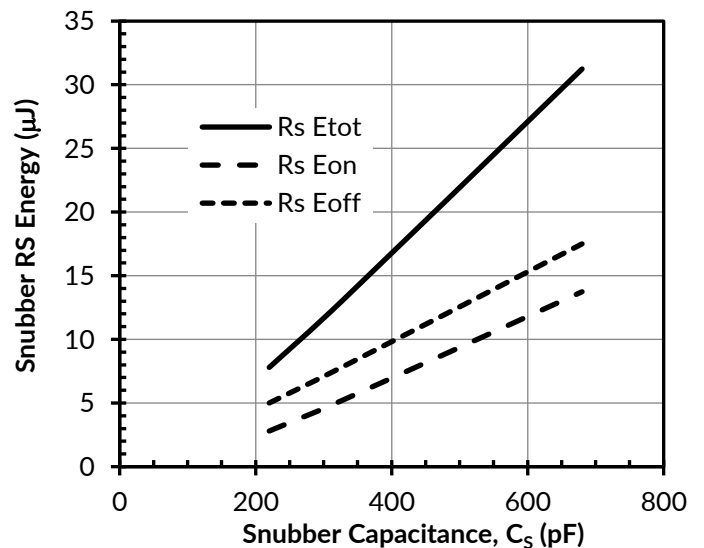

(b)

Figure 23. Clamped inductive switching energy including RC snubber energy loss (a) and RC snubber energy loss (b) as a function of snubber capacitance at $I_D = 40A$ and $T_J = 25^\circ C$

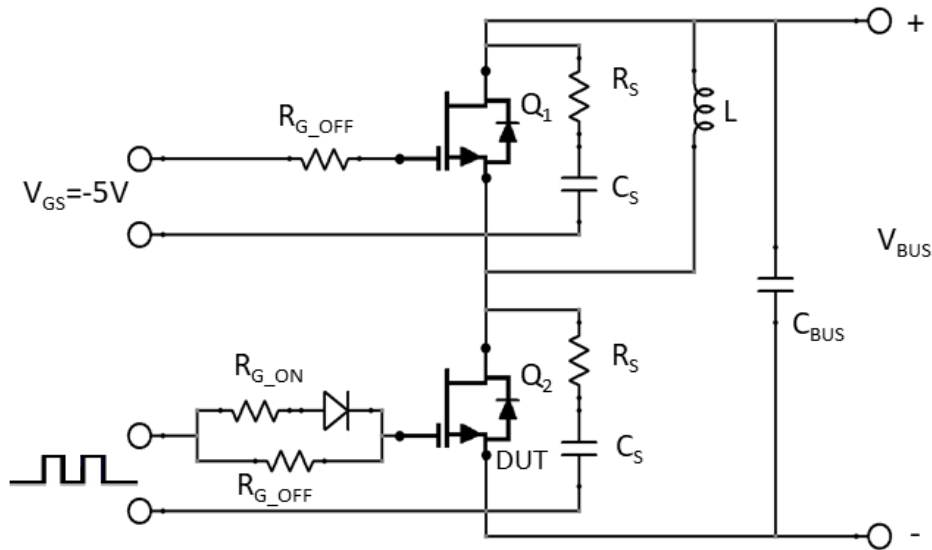

Figure 24. Clamped inductive load switching test circuit
 An RC snubber ($R_S = 5\Omega$ and $C_S = 330\text{pF}$) is required to improve the turn-off waveforms.

Applications Information

SiC cascodes are enhancement-mode power switches formed by a high-voltage SiC depletion-mode JFET and a low-voltage silicon MOSFET connected in series. The silicon MOSFET serves as the control unit while the SiC JFET provides high voltage blocking in the off state. This combination of devices in a single package provides compatibility with standard gate drivers and offers superior performance in terms of low on-resistance ($R_{DS(on)}$), output capacitance (C_{oss}), gate charge (Q_G), and reverse recovery charge (Q_{rr}) leading to low conduction and switching losses. The SiC cascodes also provide excellent reverse conduction capability eliminating the need for an external anti-parallel diode.

Like other high performance power switches, proper PCB layout design to minimize circuit parasitics is strongly recommended due to the high dv/dt and di/dt rates. An external gate resistor is recommended when the cascode is working in the diode mode in order to achieve the optimum reverse recovery performance. For more information on cascode operation, see www.unitedsic.com.

Disclaimer

United Silicon Carbide, Inc. reserves the right to change or modify any of the products and their inherent physical and technical specifications without prior notice. United Silicon Carbide, Inc. assumes no responsibility or liability for any errors or inaccuracies within.

Information on all products and contained herein is intended for description only. No license, express or implied, to any intellectual property rights is granted within this document.

United Silicon Carbide, Inc. assumes no liability whatsoever relating to the choice, selection or use of the United Silicon Carbide, Inc. products and services described herein.

Данный компонент на территории Российской Федерации

Вы можете приобрести в компании MosChip.

Для оперативного оформления запроса Вам необходимо перейти по данной ссылке:

<http://moschip.ru/get-element>

Вы можете разместить у нас заказ для любого Вашего проекта, будь то серийное производство или разработка единичного прибора.

В нашем ассортименте представлены ведущие мировые производители активных и пассивных электронных компонентов.

Нашей специализацией является поставка электронной компонентной базы двойного назначения, продукции таких производителей как XILINX, Intel (ex.ALTERA), Vicor, Microchip, Texas Instruments, Analog Devices, Mini-Circuits, Amphenol, Glenair.

Сотрудничество с глобальными дистрибьюторами электронных компонентов, предоставляет возможность заказывать и получать с международных складов практически любой перечень компонентов в оптимальные для Вас сроки.

На всех этапах разработки и производства наши партнеры могут получить квалифицированную поддержку опытных инженеров.

Система менеджмента качества компании отвечает требованиям в соответствии с ГОСТ Р ИСО 9001, ГОСТ РВ 0015-002 и ЭС РД 009

Офис по работе с юридическими лицами:

105318, г.Москва, ул.Щербаковская д.3, офис 1107, 1118, ДЦ «Щербаковский»

Телефон: +7 495 668-12-70 (многоканальный)

Факс: +7 495 668-12-70 (доб.304)

E-mail: info@moschip.ru

Skype отдела продаж:

moschip.ru

moschip.ru_4

moschip.ru_6

moschip.ru_9