

SMD Multilayer Chip Varistor

AMCV-1206H

RoHS
Compliant



3.2 x 1.6 x 1.05mm

FEATURES:

- SMD type, small size suitable for high density mounting
- Excellent clamping ratio and strong capability of voltage surge suppression
- Excellent solderability (Ni, Sn plating)

APPLICATIONS:

- Transient voltage protection and voltage surge suppression for LED lighting
- Suitable for LCD-TV, STB, Switch, Router, PLC, Security System, smart meters, mobile phones
- Suppressing Induced / switching over-voltage caused by lightning and power
- Protecting DC-DC Module, I/O ports, IC driver

STANDARD SPECIFICATIONS:

Operating Temperature: -55°C ~ +125°C

Storage Temperature: -10°C ~ +40°C and RH 70% (Max.)

Part Number	Max. Working Voltage		Varistor Voltage	Max. Clamping Voltage		Rated Single Pulse Transient		Typical Capacitance
	DC	AC RMS		8/20 μ s	ESD	Energy 10/1000 μ s	Peak Current 8/20 μ s	
Test Condition	<20 μ A		@1mA DC	V _C	I _C	E _T	I _P	@1V _{rms} , 1kHz
Units	Volts	Volts						
Symbol	V _{WDC}	V _{WAC}	V _B	V _C	I _C	E _T	I _P	C _P
AMCV-1206H-5R5	5.5	4.0	12.0 [10.0-14.0]	18	5.0	0.7	300	2400
AMCV-1206H-090	9	6.4	14.0 [12.0-16.0]	20	5.0	0.7	300	2000
AMCV-1206H-120	12	8.5	16.0 [13.0-19.0]	25	5.0	0.7	300	1600
AMCV-1206H-140	14	10.0	19.0 [16.0-22.0]	30	5.0	0.7	300	1500
AMCV-1206H-180	18	12.7	25.0 [22.0-28.0]	40	5.0	0.7	300	1300
AMCV-1206H-220	22	15.6	30.0 [26.0-34.0]	45	5.0	0.7	300	1100
AMCV-1206H-260	26	18.4	35.0 [31.0-38.0]	58	5.0	0.7	250	900
AMCV-1206H-300	30	21.3	42.0 [37.0-46.0]	65	5.0	0.7	250	800
AMCV-1206H-380	38	30.0	50.0 [46.0-54.0]	75	5.0	1.0	250	500
AMCV-1206H-480	48	34.1	60.0 [54.0-67.0]	100	5.0	1.0	250	300
AMCV-1206H-560	56	40.0	68.0 [61.0-75.0]	120	5.0	1.0	250	250
AMCV-1206H-600	60	46.0	76.0 [69.0-83.0]	130	5.0	1.0	250	200
AMCV-1206H-650	65	50.0	82.0 [73.0-91.0]	140	5.0	1.2	250	160
AMCV-1206H-750	75	55.0	94.0 [85.0-103.0]	160	5.0	1.2	250	140
AMCV-1206H-850	85	60.0	100.0 [90.0-110.0]	170	5.0	1.2	250	120
AMCV-1206H-101	100	75.0	120.0 [108.0-132.0]	200	5.0	1.2	250	80

Unless otherwise specified, the standard atmospheric conditions for measurement/test as:

- Ambient Temperature: 20 \pm 15°C
- Relative Humidity: 65 \pm 20%
- Air Pressure: 86 kPa to 106 kPa

Items	Test Methods and Remarks
Varistor Voltage at 1mA DC (V _B)	Measuring current: 1mA DC Duration: 0.2 to 2 sec
Capacitance (C)	Measure source: 1.0 V _{RMS} Test frequency: 1kHz.
Clamping Voltage (V _C)	Measuring source: 8/20us waveform

ABRACON IS
ISO 9001:2008
CERTIFIED



Visit www.abracon.com for Terms & Conditions of Sale **Revised: 11.22.12**
30332 Esperanza, Rancho Santa Margarita, California 92688
tel 949-546-8000 | fax 949-546-8001 | www.abracon.com

SMD Multilayer Chip Varistor



3.2 x 1.6 x 1.05mm

AMCV-1206H

RoHS
Compliant

OPTIONS AND PART IDENTIFICATION:

AMCV-1206H--

Voltage Code

Please refer to the table above

Packaging

T: Tape and Reel
(3kpcs / reel)

V/I CHARACTERISTICS

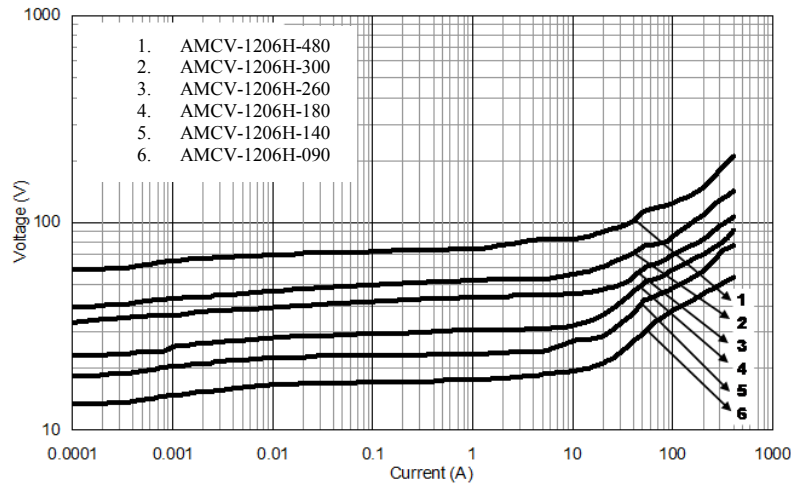

OUTLINE DIMENSION:

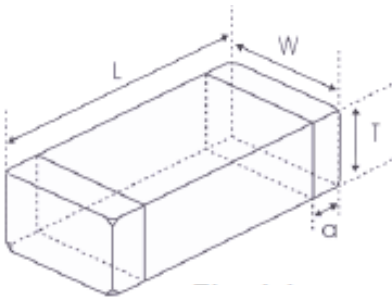

L	W	T	a
3.2±0.2	1.6±0.2	1.05 Max.	0.2~0.8

Recommended Land Pattern

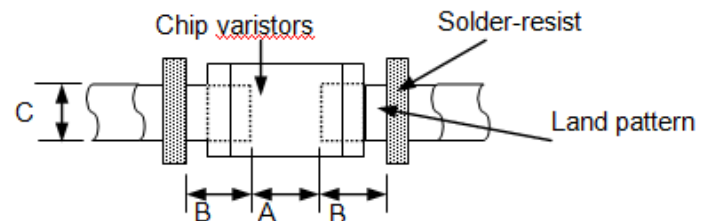

A	B	C
1.8~2.5	1.0~1.5	1.2~2.0

Dimension: mm

SMD Multilayer Chip Varistor



3.2 x 1.6 x 1.05mm

AMCV-1206H

RoHS
Compliant

Materials



	Part Name	Material
1	Base Material	ZnO
2	Internal Conductor	Ag-Pd
3	Terminal Electrode	Ag (Inner layer) Ni-Sn (Outer layer)

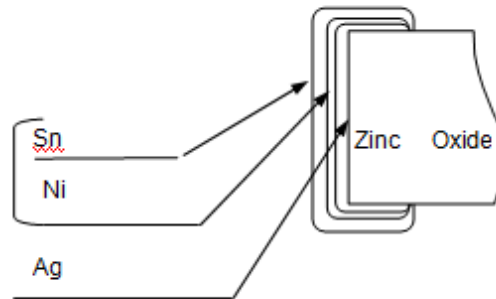

REFLOW PROFILE:

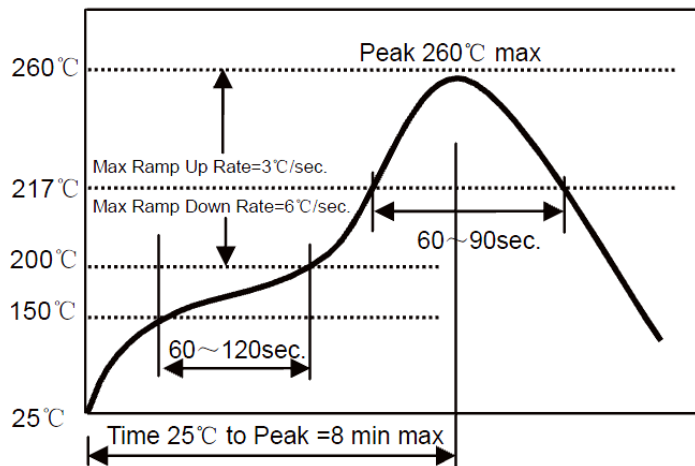

Preheat Condition	150 to 200 °C; 60 to 120 sec.
Allowed time above 217 °C	60 to 90 sec.
Max temperature	260 °C
Max time at max temperature	10 sec.
Solder paste	Sn/3.0Ag/0.5Cu
Allowed Reflow time	2x max.

SMD Multilayer Chip Varistor

AMCV-1206H

RoHS
Compliant



3.2 x 1.6 x 1.05mm

TAPE & REEL:

T: 3,000pcs / reel

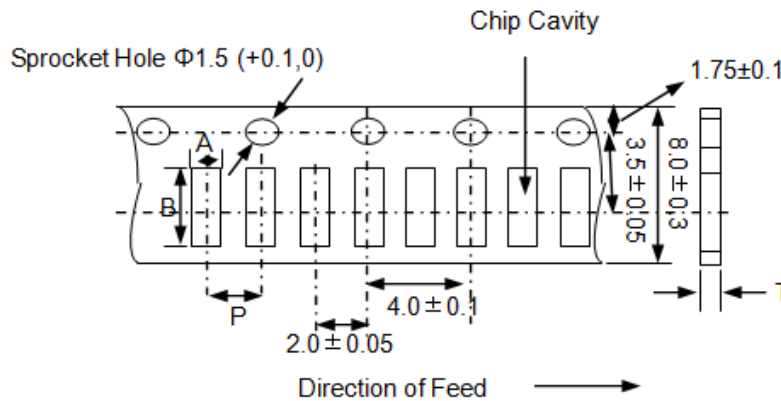

A	B	P	T (max)
1.90	3.50	4.0	1.10

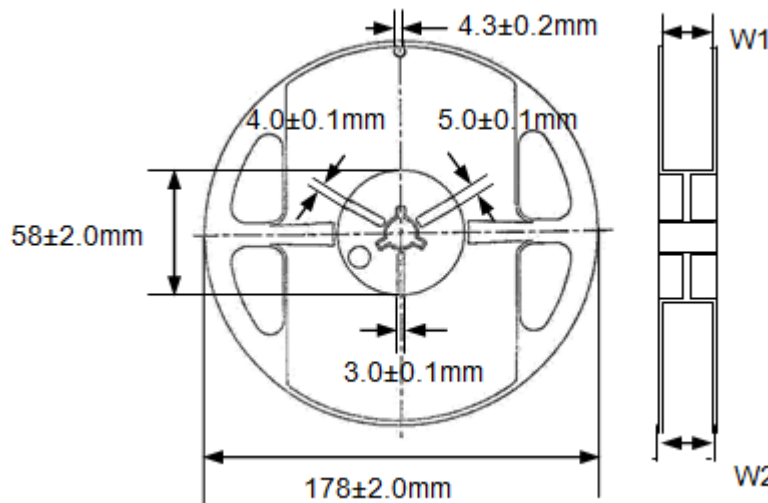

W1	W2
10.0 ± 0.5	12.5 ± 0.5

Storage Conditions

- The solderability of the external electrode may be deteriorated if packages are stored where they are exposed to high humidity. Package must be stored at 40°C or less and 70% RH or less.
- The solderability of the external electrode may be deteriorated if packages are stored where they are exposed to dust or harmful gas (e.g. HCl, sulfurous gas of H₂S).
- Packaging material may be deformed if package are stored where they are exposed to heat of direct sunlight.
- Solderability shall be guaranteed for 6 months from the date of delivery on condition that they are stored at the environment specified in 1.3. The parts that are stored more than 6 months shall be checked solderability before use.

Dimension: mm

ATTENTION: Abracon Corporation's products are COTS – Commercial-Off-The-Shelf products; suitable for Commercial, Industrial and, where designated, Automotive Applications. Abracon's products are not specifically designed for Military, Aviation, Aerospace, Life-dependant Medical applications or any application requiring high reliability where component failure could result in loss of life and/or property. For applications requiring high reliability and/or presenting an extreme operating environment, written consent and authorization from Abracon Corporation is required. Please contact Abracon Corporation for more information.

ABRACON IS
ISO 9001:2008
CERTIFIED



Visit www.abracon.com for Terms & Conditions of Sale **Revised: 11.22.12**
30332 Esperanza, Rancho Santa Margarita, California 92688
tel 949-546-8000 | fax 949-546-8001 | www.abracon.com

Данный компонент на территории Российской Федерации

Вы можете приобрести в компании MosChip.

Для оперативного оформления запроса Вам необходимо перейти по данной ссылке:

<http://moschip.ru/get-element>

Вы можете разместить у нас заказ для любого Вашего проекта, будь то серийное производство или разработка единичного прибора.

В нашем ассортименте представлены ведущие мировые производители активных и пассивных электронных компонентов.

Нашей специализацией является поставка электронной компонентной базы двойного назначения, продукции таких производителей как XILINX, Intel (ex.ALTERA), Vicor, Microchip, Texas Instruments, Analog Devices, Mini-Circuits, Amphenol, Glenair.

Сотрудничество с глобальными дистрибьюторами электронных компонентов, предоставляет возможность заказывать и получать с международных складов практически любой перечень компонентов в оптимальные для Вас сроки.

На всех этапах разработки и производства наши партнеры могут получить квалифицированную поддержку опытных инженеров.

Система менеджмента качества компании отвечает требованиям в соответствии с ГОСТ Р ИСО 9001, ГОСТ РВ 0015-002 и ЭС РД 009

Офис по работе с юридическими лицами:

105318, г.Москва, ул.Щербаковская д.3, офис 1107, 1118, ДЦ «Щербаковский»

Телефон: +7 495 668-12-70 (многоканальный)

Факс: +7 495 668-12-70 (доб.304)

E-mail: info@moschip.ru

Skype отдела продаж:

moschip.ru

moschip.ru_4

moschip.ru_6

moschip.ru_9