

# Silicon PIN Photodiode with Daylight Blocking Filter

## Version 1.4

---

### BP 104 F



#### Features:

- Especially suitable for applications of 950 nm
- Short switching time (typ. 20 ns)
- DIL plastic package with high packing density
- The product qualification test plan is based on the guidelines of AEC-Q101-REV-C, Stress Test Qualification for Automotive Grade Discrete Semiconductors.

#### Applications

- Photointerrupters
- Remote control

#### Ordering Information

Type:	Photocurrent $I_P$ [ $\mu$ A] $\lambda = 950 \text{ nm}$ , $E_e = 1 \text{ mW/cm}^2$ , $V_R = 5 \text{ V}$	Ordering Code
BP 104 F	34 ( $\geq 25$ )	Q62702P0084

**Maximum Ratings** ( $T_A = 25\text{ °C}$ )

Parameter	Symbol	Values	Unit
Operating and storage temperature range	$T_{op}; T_{stg}$	-40 ... 100	°C
Reverse voltage	$V_R$	20	V
Total Power dissipation	$P_{tot}$	150	mW
ESD withstand voltage (acc. to ANSI/ ESDA/ JEDEC JS-001 - HBM)	$V_{ESD}$	2000	V

**Characteristics** ( $T_A = 25\text{ °C}$ )

Parameter	Symbol	Values	Unit
Photocurrent ( $V_R = 5\text{ V}$ , $E_e = 1\text{ mW/cm}^2$ , $\lambda = 950\text{ nm}$ )	(typ (min)) $I_p$	34 ( $\geq 25$ )	$\mu\text{A}$
Wavelength of max. sensitivity	(typ) $\lambda_{S\max}$	950	nm
Spectral range of sensitivity	(typ) $\lambda_{10\%}$	(typ) 800 ... 1100	nm
Radiant sensitive area	(typ) $A$	4.84	$\text{mm}^2$
Dimensions of radiant sensitive area	(typ) $L \times W$	2.2 x 2.2	mm x mm
Half angle	(typ) $\varphi$	$\pm 60$	°
Dark current ( $V_R = 10\text{ V}$ )	(typ (max)) $I_R$	2 ( $\leq 30$ )	nA
Spectral sensitivity of the chip ( $\lambda = 950\text{ nm}$ )	(typ) $S_{\lambda\text{ typ}}$	0.7	A / W
Quantum yield of the chip ( $\lambda = 950\text{ nm}$ )	(typ) $\eta$	0.91	Electrons / Photon
Open-circuit voltage ( $E_e = 0.5\text{ mW/cm}^2$ , $\lambda = 950\text{ nm}$ )	(typ (min)) $V_O$	330 ( $\geq 250$ )	mV
Short-circuit current ( $E_e = 0.5\text{ mW/cm}^2$ , $\lambda = 950\text{ nm}$ )	(typ) $I_{SC}$	17	$\mu\text{A}$
Rise and fall time ( $V_R = 5\text{ V}$ , $R_L = 50\ \Omega$ , $\lambda = 850\text{ nm}$ , $I_p = 800\ \mu\text{A}$ )	(typ) $t_r, t_f$	0.02	$\mu\text{s}$
Forward voltage ( $I_F = 100\text{mA}$ , $E_e = 0$ )	(typ) $V_F$	1.3	V
Capacitance ( $V_R = 0\text{ V}$ , $f = 1\text{ MHz}$ , $E = 0$ )	(typ) $C_0$	48	pF
Temperature coefficient of $V_O$	(typ) $TC_V$	-2.6	mV / K

Parameter		Symbol	Values	Unit
Temperature coefficient of $I_{SC}$ ( $\lambda = 950 \text{ nm}$ )	(typ)	$TC_1$	0.18	% / K
Noise equivalent power ( $V_R = 10 \text{ V}$ , $\lambda = 950 \text{ nm}$ )	(typ)	NEP	0.036	$\text{pW} / \text{Hz}^{1/2}$
Detection limit	(typ)	$D^*$	$6.1 \times 10^{12}$	$\text{cm} \times \text{Hz}^{1/2} / \text{W}$

### Relative Spectral Sensitivity <sup>1) page 8</sup>

$$S_{rel} = f(\lambda)$$

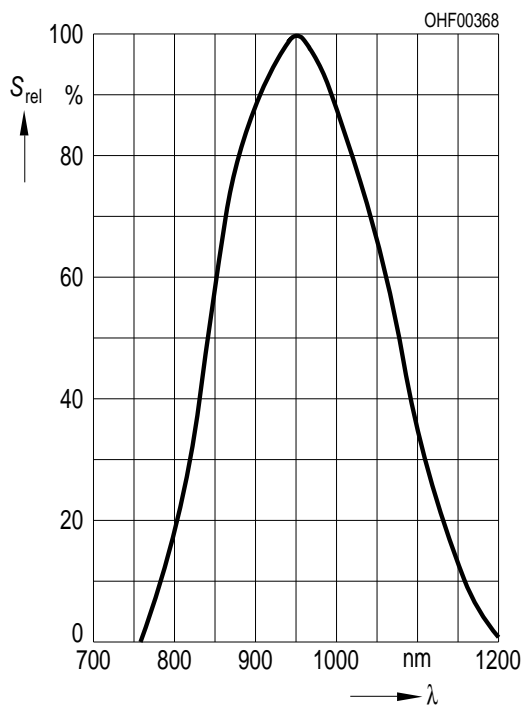

### Photocurrent / Open-Circuit Voltage <sup>1) page 8</sup>

$$I_P (V_R = 5 \text{ V}) / V_O = f(E_e)$$

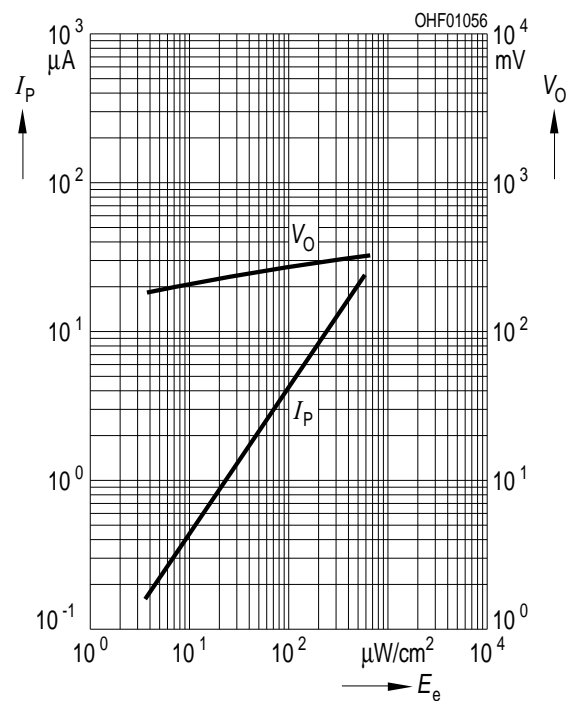

**Power Consumption**

$P_{tot} = f(T_A)$



**Dark Current** <sup>1) page 8</sup>

$I_R = f(V_R), E = 0$



**Dark Current** <sup>1) page 8</sup>

$I_R = f(V_R), E = 0$

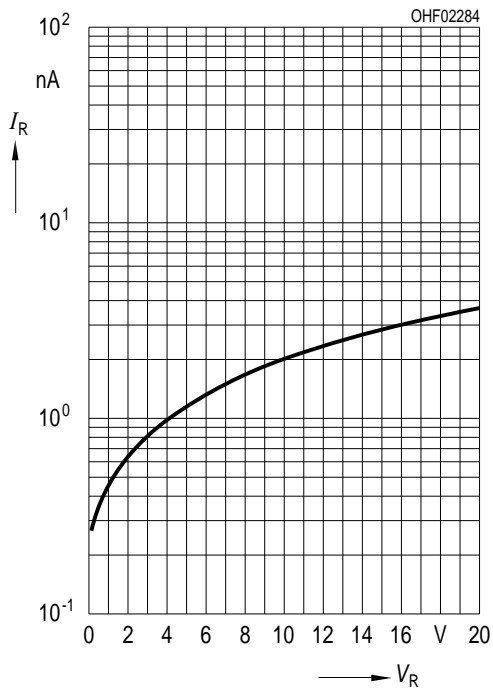

**Capacitance** <sup>1) page 8</sup>

$C = f(V_R), f = 1 \text{ MHz}, E = 0$

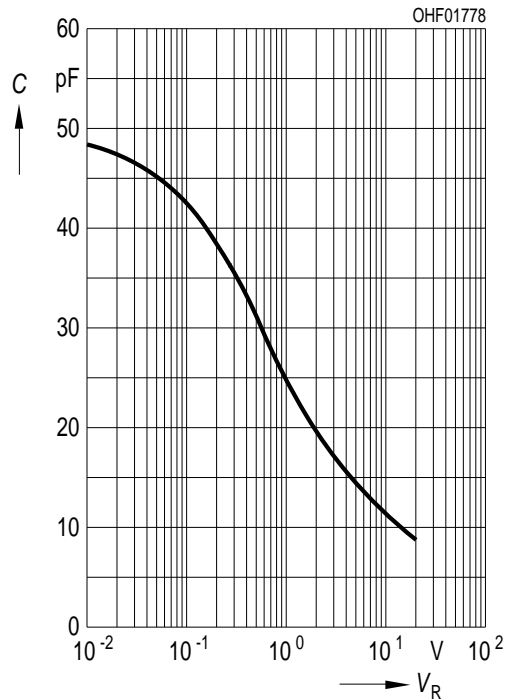

**Dark Current** <sup>1) page 8</sup>

$I_R = f(T_A), V_R = 10\text{ V}, E = 0$

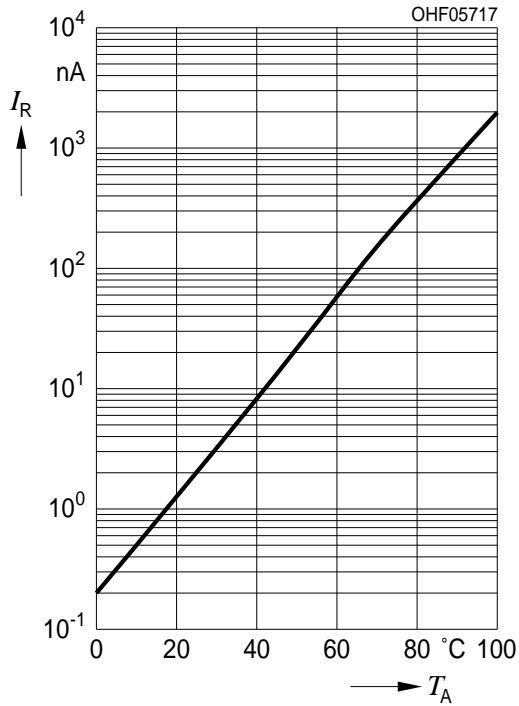

**Directional Characteristics** <sup>1) page 8</sup>

$S_{rel} = f(\phi)$

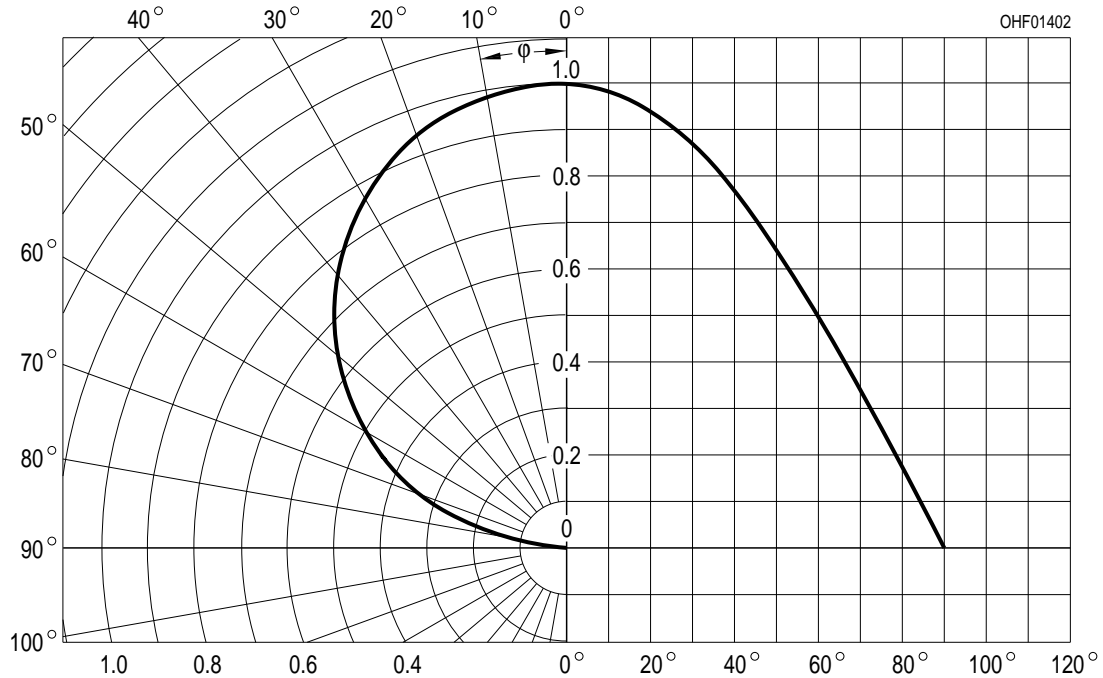

## Package Outline

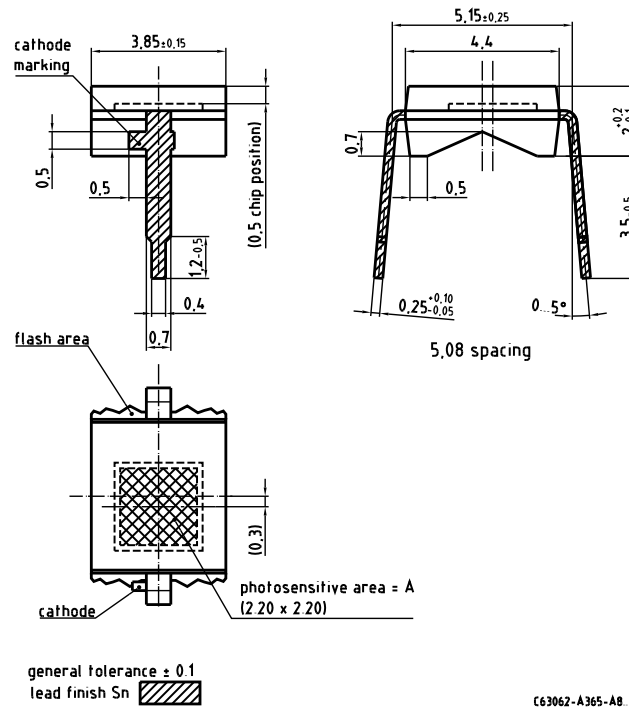

*Dimensions in mm (inch).*

**Package**

DIL, Epoxy

**Approximate Weight:**

72 mg

**TTW Soldering**

IEC-61760-1 TTW

**Disclaimer**

Language english will prevail in case of any discrepancies or deviations between the two language wordings.

**Attention please!**

The information describes the type of component and shall not be considered as assured characteristics.

Terms of delivery and rights to change design reserved. Due to technical requirements components may contain dangerous substances.

For information on the types in question please contact our Sales Organization.

If printed or downloaded, please find the latest version in the Internet.

**Packing**

Please use the recycling operators known to you. We can also help you – get in touch with your nearest sales office. By agreement we will take packing material back, if it is sorted. You must bear the costs of transport. For packing material that is returned to us unsorted or which we are not obliged to accept, we shall have to invoice you for any costs incurred.

**Components used in life-support devices or systems must be expressly authorized for such purpose!**

Critical components\* may only be used in life-support devices\*\* or systems with the express written approval of OSRAM OS.

\*) A critical component is a component used in a life-support device or system whose failure can reasonably be expected to cause the failure of that life-support device or system, or to affect its safety or the effectiveness of that device or system.

\*\*) Life support devices or systems are intended (a) to be implanted in the human body, or (b) to support and/or maintain and sustain human life. If they fail, it is reasonable to assume that the health and the life of the user may be endangered.

**Glossary**

- <sup>1)</sup> **Typical Values:** Due to the special conditions of the manufacturing processes of LED, the typical data or calculated correlations of technical parameters can only reflect statistical figures. These do not necessarily correspond to the actual parameters of each single product, which could differ from the typical data and calculated correlations or the typical characteristic line. If requested, e.g. because of technical improvements, these typ. data will be changed without any further notice.



**Published by OSRAM Opto Semiconductors GmbH**  
**Leibnizstraße 4, D-93055 Regensburg**  
**www.osram-os.com © All Rights Reserved.**

EU RoHS and China RoHS compliant product



此产品符合欧盟 RoHS 指令的要求；  
按照中国的相关法规和标准，不含有毒有害物质或元素。

## Данный компонент на территории Российской Федерации

### Вы можете приобрести в компании MosChip.

Для оперативного оформления запроса Вам необходимо перейти по данной ссылке:

<http://moschip.ru/get-element>

Вы можете разместить у нас заказ для любого Вашего проекта, будь то серийное производство или разработка единичного прибора.

В нашем ассортименте представлены ведущие мировые производители активных и пассивных электронных компонентов.

Нашей специализацией является поставка электронной компонентной базы двойного назначения, продукции таких производителей как XILINX, Intel (ex.ALTERA), Vicor, Microchip, Texas Instruments, Analog Devices, Mini-Circuits, Amphenol, Glenair.

Сотрудничество с глобальными дистрибьюторами электронных компонентов, предоставляет возможность заказывать и получать с международных складов практически любой перечень компонентов в оптимальные для Вас сроки.

На всех этапах разработки и производства наши партнеры могут получить квалифицированную поддержку опытных инженеров.

Система менеджмента качества компании отвечает требованиям в соответствии с ГОСТ Р ИСО 9001, ГОСТ РВ 0015-002 и ЭС РД 009

### Офис по работе с юридическими лицами:

105318, г.Москва, ул.Щербаковская д.3, офис 1107, 1118, ДЦ «Щербаковский»

Телефон: +7 495 668-12-70 (многоканальный)

Факс: +7 495 668-12-70 (доб.304)

E-mail: [info@moschip.ru](mailto:info@moschip.ru)

Skype отдела продаж:

moschip.ru

moschip.ru\_4

moschip.ru\_6

moschip.ru\_9