

Cree® 5mm Round LED

C513A-WSS/WSN

C513A-MSS/MSN

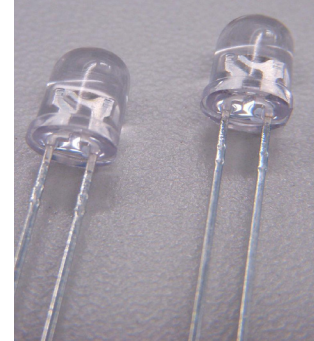

PRODUCT DESCRIPTION

Round LEDs offer superior light output for excellent readability in sunlight and dependable performance. They provide extremely stable light output over long periods of time.

These lamps are made with an advanced optical grade epoxy offering superior high temperature and high moisture resistance performance in lighting and illumination applications.

FEATURES

- Size (mm): 5
- Color Temperatures:
Cool White :
Min . (4600K) / Typical (9000K)
Warm White :
Min . (2500K) / Typical (2800K)
- Luminous Intensity (mcd)
C513A-WSS/WSN:(3000-12000)
C513A-MSS/MSN:(3000-12000)
- CRI:
Typical CRI for Cool White is 75
Typical CRI for Warm White is 80
- Viewing angle:
C513A-WSS/WSN: 55 degree
C513A-MSS/MSN: 55 degree
- Lead-Free
- RoHS Compliant

APPLICATIONS

- Torch
- Channel Letter
- Retail Display Lighting

ABSOLUTE MAXIMUM RATINGS ($T_A = 25^\circ\text{C}$)

Items	Symbol	Absolute Maximum Rating	Unit
		Cool/Warm	
Forward Current	I_F	30	mA
Peak Forward Current ^{Note}	I_{FP}	100	mA
Reverse Voltage	V_R	5	V
Power Dissipation	P_D	120	mW
Operation Temperature	T_{opr}	-40 ~ +95	$^\circ\text{C}$
Storage Temperature	T_{stg}	-40 ~ +100	$^\circ\text{C}$
Lead Soldering Temperature	T_{sol}	Max. 260 $^\circ\text{C}$ for 3 sec. max. (3 mm from the base of the epoxy bulb)	

Note: Pulse width ≤ 0.1 msec, duty $\leq 1/10$.

TYPICAL ELECTRICAL & OPTICAL CHARACTERISTICS ($T_A = 25^\circ\text{C}$)

Characteristics	Color	Symbol	Condition	Unit	Minimum	Typical	Maximum	
Forward Voltage	Cool/Warm	V_F	$I_F = 20$ mA	V		3.2	4.0	
Reverse Current	Cool/Warm	I_R	$V_R = 5$ V	μA			100	
Luminous Intensity	Cool	I_V	$I_F = 20$ mA	mcd	3000	6900		
	Warm	I_V	$I_F = 20$ mA	mcd	3000	5400		
Chromaticity Coordinates	Cool	x	$I_F = 20$ mA			0.2895		
		y	$I_F = 20$ mA			0.2905		
	Warm	x	$I_F = 20$ mA				0.4527	
		y	$I_F = 20$ mA				0.4255	
50% Power Angle	Cool/Warm	$2\theta_{1/2}$	$I_F = 20$ mA	deg		55		

INTENSITY BIN LIMIT ($I_F = 20 \text{ mA}$)

Cool White(C513A-WSS/WSN)

Bin Code	Min.(mcd)	Max.(mcd)
W0	3000	4180
X0	4180	5860
Y0	5860	8200
Z0	8200	12000

Warm White(C513A-MSS/MSN)

Bin Code	Min.(mcd)	Max.(mcd)
W0	3000	4180
X0	4180	5860
Y0	5860	8200
Z0	8200	12000

- Tolerance of measurement of luminous intensity is $\pm 15\%$

VF BIN LIMIT ($I_F = 20 \text{ mA}$)

Cool White(C513A-WSS/WSN)

Bin Code	Min.(V)	Max.(V)
27	2.8	3.0
28	3.0	3.2
29	3.2	3.4
2a	3.4	3.6
2b	3.6	3.8
2c	3.8	4.0

Warm White(C513A-MSS/MSN)

Bin Code	Min.(V)	Max.(V)
27	2.8	3.0
28	3.0	3.2
29	3.2	3.4
2a	3.4	3.6
2b	3.6	3.8
2c	3.8	4.0

- Tolerance of measurement of VF is $\pm 0.05\text{V}$.

COLOR BIN LIMIT ($I_F = 20 \text{ mA}$)

Cool White

Bin Code	Sub-bin	x	y
W1	Wa1	0.2449	0.2288
		0.2497	0.2384
		0.2543	0.2356
		0.2497	0.2267
	Wa2	0.2497	0.2267
		0.2543	0.2356
		0.2589	0.2328
		0.2545	0.2245
	Wa3	0.2497	0.2384
		0.2545	0.2480
		0.2589	0.2445
		0.2543	0.2356
	Wa4	0.2543	0.2356
		0.2589	0.2445
		0.2633	0.2410
		0.2589	0.2328
	Wb1	0.2545	0.2245
		0.2589	0.2328
		0.2635	0.2299
		0.2593	0.2223
	Wb2	0.2593	0.2223
		0.2635	0.2299
		0.2680	0.2270
		0.2640	0.2200
	Wb3	0.2589	0.2328
		0.2633	0.2410
		0.2677	0.2375
		0.2635	0.2299
Wb4	0.2635	0.2299	
	0.2677	0.2375	
	0.2720	0.2340	
	0.2680	0.2270	

Bin Code	Sub-bin	x	y
W1	Wc1	0.2545	0.2480
		0.2593	0.2575
		0.2635	0.2534
		0.2589	0.2445
	Wc2	0.2589	0.2445
		0.2635	0.2534
		0.2677	0.2493
		0.2633	0.2410
	Wc3	0.2593	0.2575
		0.2640	0.2670
		0.2680	0.2623
		0.2635	0.2534
	Wc4	0.2635	0.2534
		0.2680	0.2623
		0.2720	0.2575
		0.2677	0.2493
	Wd1	0.2633	0.2410
		0.2677	0.2493
		0.2718	0.2451
		0.2677	0.2375
	Wd2	0.2677	0.2375
		0.2718	0.2451
		0.2760	0.2410
		0.2720	0.2340
	Wd3	0.2677	0.2493
		0.2720	0.2575
		0.2760	0.2528
		0.2718	0.2451
Wd4	0.2718	0.2451	
	0.2760	0.2528	
	0.2800	0.2480	
	0.2760	0.2410	

Bin Code	Sub-bin	x	y
W2	We1	0.2640	0.2670
		0.2688	0.2765
		0.2726	0.2711
		0.2680	0.2623
	We2	0.2680	0.2623
		0.2726	0.2711
		0.2764	0.2658
		0.2720	0.2575
	We3	0.2688	0.2765
		0.2735	0.2860
		0.2772	0.2800
		0.2726	0.2711
	We4	0.2726	0.2711
		0.2772	0.2800
		0.2808	0.2740
		0.2764	0.2658
	Wf1	0.2720	0.2575
		0.2764	0.2658
		0.2802	0.2604
		0.2760	0.2528
	Wf2	0.2760	0.2528
		0.2802	0.2604
		0.2840	0.2550
		0.2800	0.2480
	Wf3	0.2764	0.2658
		0.2808	0.2740
		0.2844	0.2680
		0.2802	0.2604
Wf4	0.2802	0.2604	
	0.2844	0.2680	
	0.2880	0.2620	
	0.2840	0.2550	

- Tolerance of measurement of the color coordinates is ± 0.01 .

COLOR BIN LIMIT ($I_f = 20 \text{ mA}$)

Cool White

Bin Code	Sub-bin	x	y
W2	Wg1	0.2735	0.2860
		0.2783	0.2955
		0.2817	0.2889
		0.2772	0.2800
	Wg2	0.2772	0.2800
		0.2817	0.2889
		0.2852	0.2823
		0.2808	0.2740
	Wg3	0.2783	0.2955
		0.2830	0.3050
		0.2863	0.2978
		0.2817	0.2889
	Wg4	0.2817	0.2889
		0.2863	0.2978
		0.2895	0.2905
		0.2852	0.2823
	Wh1	0.2808	0.2740
		0.2852	0.2823
		0.2886	0.2756
		0.2844	0.2680
	Wh2	0.2844	0.2680
		0.2886	0.2756
		0.2920	0.2690
		0.2880	0.2620
	Wh3	0.2852	0.2823
		0.2895	0.2905
		0.2928	0.2833
		0.2886	0.2756
Wh4	0.2886	0.2756	
	0.2928	0.2833	
	0.2960	0.2760	
	0.2920	0.2690	

Bin Code	Sub-bin	x	y
W3	Wj1	0.2830	0.3050
		0.2890	0.3130
		0.2918	0.3048
		0.2863	0.2978
	Wj2	0.2863	0.2978
		0.2918	0.3048
		0.2947	0.2967
		0.2895	0.2905
	Wj3	0.2890	0.3130
		0.2950	0.3210
		0.2974	0.3119
		0.2918	0.3048
	Wj4	0.2918	0.3048
		0.2974	0.3119
		0.2998	0.3028
		0.2947	0.2967
	Wk1	0.2895	0.2905
		0.2947	0.2967
		0.2975	0.2890
		0.2928	0.2833
	Wk2	0.2928	0.2833
		0.2975	0.2890
		0.3003	0.2813
		0.2960	0.2760
	Wk3	0.2947	0.2967
		0.2998	0.3028
		0.3022	0.2946
		0.2975	0.2890
Wk4	0.2975	0.2890	
	0.3022	0.2946	
	0.3045	0.2865	
	0.3003	0.2813	

Bin Code	Sub-bin	x	y
W3	Wm1	0.2950	0.3210
		0.3010	0.3290
		0.3030	0.3190
		0.2974	0.3119
	Wm2	0.2974	0.3119
		0.3030	0.3190
		0.3050	0.3090
		0.2998	0.3028
	Wm3	0.3010	0.3290
		0.3070	0.3370
		0.3085	0.3260
		0.3030	0.3190
	Wm4	0.3030	0.3190
		0.3085	0.3260
		0.3100	0.3150
		0.3050	0.3090
	Wn1	0.2998	0.3028
		0.3050	0.3090
		0.3070	0.3005
		0.3022	0.2946
	Wn2	0.3022	0.2946
		0.3070	0.3005
		0.3090	0.2920
		0.3045	0.2865
	Wn3	0.3050	0.3090
		0.3100	0.3150
		0.3115	0.3060
		0.3070	0.3005
Wn4	0.3070	0.3005	
	0.3115	0.3060	
	0.3130	0.2970	
	0.3090	0.2920	

- Tolerance of measurement of the color coordinates is ± 0.01 .

COLOR BIN LIMIT ($I_f = 20 \text{ mA}$)

Cool White

Bin Code	Sub-bin	x	y
W4	Wp1	0.3070	0.3370
		0.3130	0.3430
		0.3140	0.3320
		0.3085	0.3260
	Wp2	0.3085	0.3260
		0.3140	0.3320
		0.3150	0.3210
		0.3100	0.3150
	Wp3	0.3130	0.3430
		0.3190	0.3490
		0.3195	0.3380
		0.3140	0.3320
	Wp4	0.3140	0.3320
		0.3195	0.3380
		0.3200	0.3270
		0.3150	0.3210
	Wq1	0.3100	0.3150
		0.3150	0.3210
		0.3163	0.3118
		0.3115	0.3060
	Wq2	0.3115	0.3060
		0.3163	0.3118
		0.3175	0.3025
		0.3130	0.2970
	Wq3	0.3150	0.3210
		0.3200	0.3270
		0.3208	0.3173
		0.3163	0.3118
	Wq4	0.3163	0.3118
		0.3208	0.3173
		0.3215	0.3075
		0.3175	0.3025

Bin Code	Sub-bin	x	y
W4	Wr1	0.3190	0.3490
		0.3245	0.3545
		0.3248	0.3438
		0.3195	0.3380
	Wr2	0.3195	0.3380
		0.3248	0.3438
		0.3250	0.3330
		0.3200	0.3270
	Wr3	0.3245	0.3545
		0.3300	0.3600
		0.3300	0.3495
		0.3248	0.3438
	Wr4	0.3248	0.3438
		0.3300	0.3495
		0.3300	0.3390
		0.3250	0.3330
	Ws1	0.3200	0.3270
		0.3250	0.3330
		0.3255	0.3230
		0.3208	0.3173
	Ws2	0.3208	0.3173
		0.3255	0.3230
		0.3260	0.3130
		0.3215	0.3075
	Ws3	0.3250	0.3330
		0.3300	0.3390
		0.3300	0.3285
		0.3255	0.3230
Ws4	0.3255	0.3230	
	0.3300	0.3285	
	0.3300	0.3180	
	0.3260	0.3130	

Bin Code	Sub-bin	x	y
W5	Wt1	0.3300	0.3600
		0.3378	0.3663
		0.3375	0.3563
		0.3300	0.3495
	Wt2	0.3300	0.3495
		0.3375	0.3563
		0.3372	0.3463
		0.3300	0.3390
	Wt3	0.3378	0.3663
		0.3455	0.3725
		0.3449	0.3630
		0.3375	0.3563
	Wt4	0.3375	0.3563
		0.3449	0.3630
		0.3443	0.3535
		0.3372	0.3463
	Wu1	0.3300	0.3390
		0.3372	0.3463
		0.3368	0.3363
		0.3300	0.3285
	Wu2	0.3300	0.3285
		0.3368	0.3363
		0.3365	0.3263
		0.3300	0.3180
	Wu3	0.3372	0.3463
		0.3443	0.3535
		0.3437	0.3440
		0.3368	0.3363
	Wu4	0.3368	0.3363
		0.3437	0.3440
		0.3430	0.3345
		0.3365	0.3263

- Tolerance of measurement of the color coordinates is ± 0.01 .

COLOR BIN LIMIT ($I_f = 20 \text{ mA}$)

Cool White

Bin Code	Sub-bin	x	y
W5	Wv1	0.3455	0.3725
		0.3533	0.3788
		0.3523	0.3698
		0.3449	0.3630
	Wv2	0.3449	0.3630
		0.3523	0.3698
		0.3514	0.3608
		0.3443	0.3535
	Wv3	0.3533	0.3788
		0.3610	0.3850
		0.3598	0.3765
		0.3523	0.3698
	Wv4	0.3523	0.3698
		0.3598	0.3765
		0.3585	0.3680
		0.3514	0.3608
	Ww1	0.3443	0.3535
		0.3514	0.3608
		0.3505	0.3518
		0.3437	0.3440
	Ww2	0.3437	0.3440
		0.3505	0.3518
		0.3495	0.3428
		0.3430	0.3345
	Ww3	0.3514	0.3608
		0.3585	0.3680
		0.3573	0.3595
		0.3505	0.3518
Ww4	0.3505	0.3518	
	0.3573	0.3595	
	0.3560	0.3510	
	0.3495	0.3428	

- Tolerance of measurement of the color coordinates is ± 0.01 .

COLOR BIN LIMIT ($I_f = 20 \text{ mA}$)

Warm White

Bin Code	Sub-bin	x	y
M1	Ma1	0.3610	0.3900
		0.3715	0.3987
		0.3689	0.3853
		0.3593	0.3776
	Ma2	0.3715	0.3987
		0.3820	0.4075
		0.3786	0.3929
		0.3689	0.3853
	Ma3	0.3689	0.3853
		0.3786	0.3929
		0.3751	0.3783
		0.3664	0.3717
	Ma4	0.3593	0.3776
		0.3689	0.3853
		0.3664	0.3717
		0.3576	0.3651
	Mb1	0.3576	0.3651
		0.3664	0.3717
		0.3638	0.3582
		0.3559	0.3526
	Mb2	0.3664	0.3717
		0.3751	0.3783
		0.3717	0.3637
		0.3638	0.3582
	Mb3	0.3638	0.3582
		0.3717	0.3637
		0.3682	0.3491
		0.3612	0.3446
	Mb4	0.3559	0.3526
		0.3638	0.3582
		0.3612	0.3446
		0.3541	0.3401

Bin Code	Sub-bin	x	y
M1	Mc1	0.3820	0.4075
		0.3925	0.4163
		0.3882	0.4006
		0.3786	0.3929
	Mc2	0.3925	0.4163
		0.4030	0.4250
		0.3978	0.4083
		0.3882	0.4006
	Mc3	0.3882	0.4006
		0.3978	0.4083
		0.3926	0.3915
		0.3839	0.3849
	Mc4	0.3786	0.3929
		0.3882	0.4006
		0.3839	0.3849
		0.3751	0.3783
	Md1	0.3751	0.3783
		0.3839	0.3849
		0.3796	0.3693
		0.3717	0.3637
	Md2	0.3839	0.3849
		0.3926	0.3915
		0.3874	0.3748
		0.3796	0.3693
	Md3	0.3796	0.3693
		0.3874	0.3748
		0.3822	0.3580
		0.3752	0.3536
	Md4	0.3717	0.3637
		0.3796	0.3693
		0.3752	0.3536
		0.3682	0.3491

Bin Code	Sub-bin	x	y
M2	Me1	0.4030	0.4250
		0.4145	0.4320
		0.4084	0.4145
		0.3978	0.4083
	Me2	0.4145	0.4320
		0.4260	0.4390
		0.4189	0.4206
		0.4084	0.4145
	Me3	0.4084	0.4145
		0.4189	0.4206
		0.4118	0.4021
		0.4022	0.3968
	Me4	0.3978	0.4083
		0.4084	0.4145
		0.4022	0.3968
		0.3926	0.3915
	Mf1	0.3926	0.3915
		0.4022	0.3968
		0.3961	0.3793
		0.3874	0.3748
	Mf2	0.4022	0.3968
		0.4118	0.4021
		0.4047	0.3837
		0.3961	0.3793
	Mf3	0.3961	0.3793
		0.4047	0.3837
		0.3976	0.3653
		0.3899	0.3617
	Mf4	0.3874	0.3748
		0.3961	0.3793
		0.3899	0.3617
		0.3822	0.3580

- Tolerance of measurement of the color coordinates is ± 0.01 .

COLOR BIN LIMIT ($I_F = 20 \text{ mA}$)

Warm White

Bin Code	Sub-bin	x	y
M2	Mg1	0.4260	0.4390
		0.4375	0.4460
		0.4295	0.4268
		0.4189	0.4206
	Mg2	0.4375	0.4460
		0.4490	0.4530
		0.4400	0.4329
		0.4295	0.4268
	Mg3	0.4295	0.4268
		0.4400	0.4329
		0.4310	0.4128
		0.4214	0.4075
	Mg4	0.4189	0.4206
		0.4295	0.4268
		0.4214	0.4075
		0.4118	0.4021
	Mh1	0.4118	0.4021
		0.4214	0.4075
		0.4134	0.3882
		0.4047	0.3837
	Mh2	0.4214	0.4075
		0.4310	0.4128
		0.4220	0.3927
		0.4134	0.3882
	Mh3	0.4134	0.3882
		0.4220	0.3927
		0.4129	0.3725
		0.4053	0.3689
Mh4	0.4047	0.3837	
	0.4134	0.3882	
	0.4053	0.3689	
	0.3976	0.3653	

Bin Code	Sub-bin	x	y
M3	Mj1	0.4490	0.4530
		0.4638	0.4578
		0.4540	0.4372
		0.4400	0.4329
	Mj2	0.4638	0.4578
		0.4785	0.4625
		0.4679	0.4414
		0.4540	0.4372
	Mj3	0.4540	0.4372
		0.4679	0.4414
		0.4572	0.4203
		0.4441	0.4166
	Mj4	0.4400	0.4329
		0.4540	0.4372
		0.4441	0.4166
		0.4310	0.4128
	Mk1	0.4310	0.4128
		0.4441	0.4166
		0.4343	0.3960
		0.4220	0.3927
	Mk2	0.4441	0.4166
		0.4572	0.4203
		0.4466	0.3993
		0.4343	0.3960
	Mk3	0.4343	0.3960
		0.4466	0.3993
		0.4359	0.3782
		0.4244	0.3754
Mk4	0.4220	0.3927	
	0.4343	0.3960	
	0.4244	0.3754	
	0.4129	0.3726	

Bin Code	Sub-bin	x	y
M3	Mm1	0.4785	0.4625
		0.4933	0.4673
		0.4818	0.4457
		0.4679	0.4414
	Mm2	0.4933	0.4673
		0.5080	0.4720
		0.4957	0.4500
		0.4818	0.4457
	Mm3	0.4818	0.4457
		0.4957	0.4500
		0.4834	0.4279
		0.4703	0.4241
	Mm4	0.4679	0.4414
		0.4818	0.4457
		0.4703	0.4241
		0.4572	0.4203
	Mn1	0.4572	0.4203
		0.4703	0.4241
		0.4589	0.4026
		0.4466	0.3993
	Mn2	0.4703	0.4241
		0.4834	0.4279
		0.4711	0.4059
		0.4589	0.4026
	Mn3	0.4589	0.4026
		0.4711	0.4059
		0.4588	0.3838
		0.4474	0.3810
Mn4	0.4466	0.3993	
	0.4589	0.4026	
	0.4474	0.3810	
	0.4359	0.3782	

- Tolerance of measurement of the color coordinates is ± 0.01 .

CIE CHROMATICITY DIAGRAM

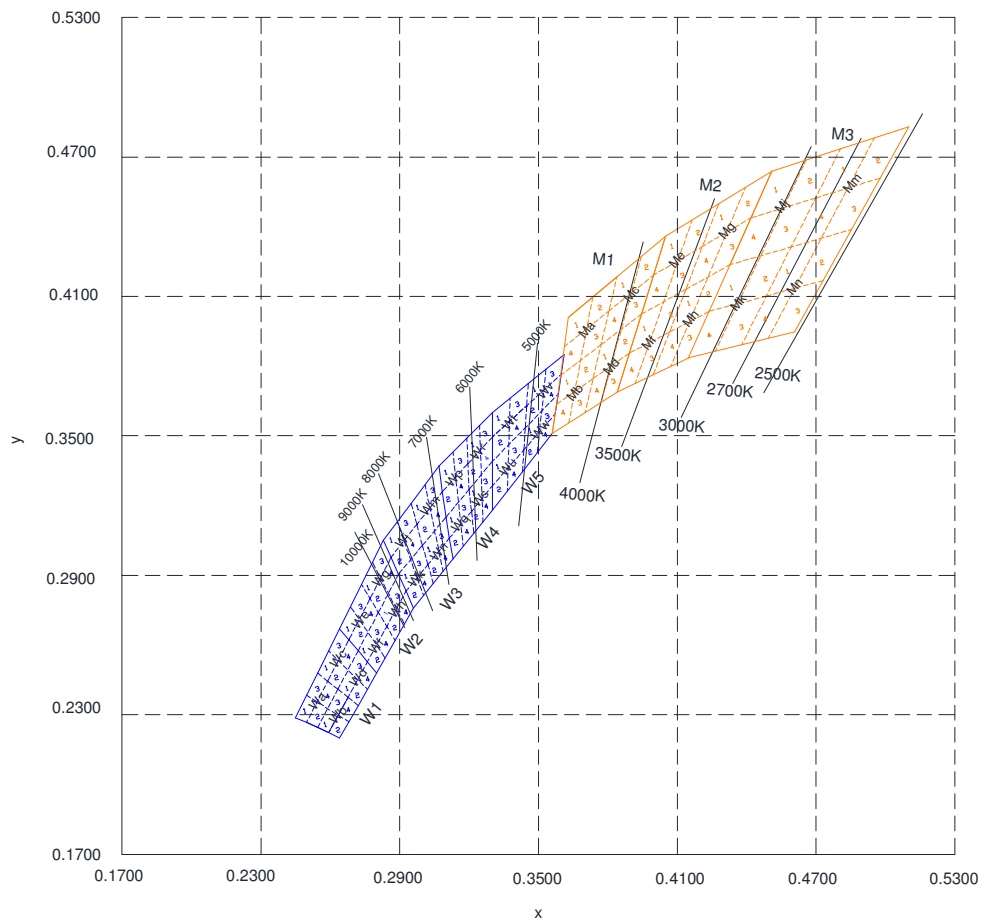

ORDER CODE TABLE*

Cool White

Color	Kit Number	Viewing Angle	Luminous Intensity (mcd)		Color Bin Code	Package	Standoff
			Min.	Max.			
Cool White	C513A-WSS-CW0Z0151	55	3000	12000	W1,W2,W3,W4,W5	Bulk	Yes
Cool White	C513A-WSS-CX0Z0231	55	4180	12000	W2,W3	Bulk	Yes
Cool White	C513A-WSS-CX0Z0341	55	4180	12000	W3,W4	Bulk	Yes
Cool White	C513A-WSS-CY0Z0231	55	5860	12000	W2,W3	Bulk	Yes
Cool White	C513A-WSS-CY0Z0341	55	5860	12000	W3,W4	Bulk	Yes
Cool White	C513A-WSS-CW0Z0152	55	3000	12000	W1,W2,W3,W4,W5	Ammo	Yes
Cool White	C513A-WSS-CX0Z0232	55	4180	12000	W2,W3	Ammo	Yes
Cool White	C513A-WSS-CX0Z0342	55	4180	12000	W3,W4	Ammo	Yes
Cool White	C513A-WSS-CY0Z0232	55	5860	12000	W2,W3	Ammo	Yes
Cool White	C513A-WSS-CY0Z0342	55	5860	12000	W3,W4	Ammo	Yes
Cool White	C513A-WSN-CW0Z0151	55	3000	12000	W1,W2,W3,W4,W5	Bulk	No
Cool White	C513A-WSN-CX0Z0231	55	4180	12000	W2,W3	Bulk	No
Cool White	C513A-WSN-CX0Z0341	55	4180	12000	W3,W4	Bulk	No
Cool White	C513A-WSN-CY0Z0231	55	5860	12000	W2,W3	Bulk	No
Cool White	C513A-WSN-CY0Z0341	55	5860	12000	W3,W4	Bulk	No
Cool White	C513A-WSN-CW0Z0152	55	3000	12000	W1,W2,W3,W4,W5	Ammo	No
Cool White	C513A-WSN-CX0Z0232	55	4180	12000	W2,W3	Ammo	No
Cool White	C513A-WSN-CX0Z0342	55	4180	12000	W3,W4	Ammo	No
Cool White	C513A-WSN-CY0Z0232	55	5860	12000	W2,W3	Ammo	No
Cool White	C513A-WSN-CY0Z0342	55	5860	12000	W3,W4	Ammo	No

ORDER CODE TABLE*

Warm White

Color	Kit Number	Viewing Angle	Luminous Intensity (mcd)		Color Bin Code	Package	Standoff
			Min.	Max.			
Warm White	C513A-MSS-CW0Z0131	55	3000	12000	M1,M2,M3	Bulk	Yes
Warm White	C513A-MSS-CW0Z0231	55	3000	12000	M2,M3	Bulk	Yes
Warm White	C513A-MSS-CX0Z0231	55	4180	12000	M2,M3	Bulk	Yes
Warm White	C513A-MSS-CW0Z0511	55	3000	12000	W5,M1	Bulk	Yes
Warm White	C513A-MSS-CX0Z0511	55	4180	12000	W5,M1	Bulk	Yes
Warm White	C513A-MSS-CW0Z0132	55	3000	12000	M1,M2,M3	Ammo	Yes
Warm White	C513A-MSS-CW0Z0232	55	3000	12000	M2,M3	Ammo	Yes
Warm White	C513A-MSS-CX0Z0232	55	4180	12000	M2,M3	Ammo	Yes
Warm White	C513A-MSS-CW0Z0512	55	3000	12000	W5,M1	Ammo	Yes
Warm White	C513A-MSS-CX0Z0512	55	4180	12000	W5,M1	Ammo	Yes
Warm White	C513A-MSN-CW0Z0131	55	3000	12000	M1,M2,M3	Bulk	No
Warm White	C513A-MSN-CW0Z0231	55	3000	12000	M2,M3	Bulk	No
Warm White	C513A-MSN-CX0Z0231	55	4180	12000	M2,M3	Bulk	No
Warm White	C513A-MSN-CW0Z0511	55	3000	12000	W5,M1	Bulk	No
Warm White	C513A-MSN-CX0Z0511	55	4180	12000	W5,M1	Bulk	No
Warm White	C513A-MSN-CW0Z0132	55	3000	12000	M1,M2,M3	Ammo	No
Warm White	C513A-MSN-CW0Z0232	55	3000	12000	M2,M3	Ammo	No
Warm White	C513A-MSN-CX0Z0232	55	4180	12000	M2,M3	Ammo	No
Warm White	C513A-MSN-CW0Z0512	55	3000	12000	W5,M1	Ammo	No
Warm White	C513A-MSN-CX0Z0512	55	4180	12000	W5,M1	Ammo	No

Notes:

1. The above kit numbers represent order codes that include multiple intensity-bin and color-bin codes. Only one intensity-bin code and one color-bin code will be shipped on each bulk. Single intensity-bin code and single color-bin codes will not be orderable.
2. Please refer to the "Cree LED Lamp Reliability Test Standards" document for reliability test conditions.
3. Please refer to the "Cree LED Lamp Soldering & Handling" document for information about how to use this LED product safely.

GRAPHS

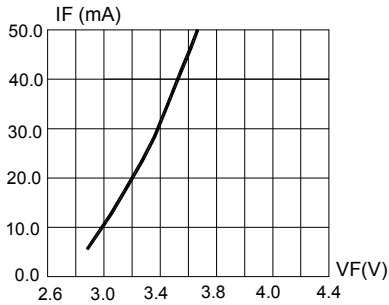

FIG.1 FORWARD CURRENT VS. FORWARD VOLTAGE.

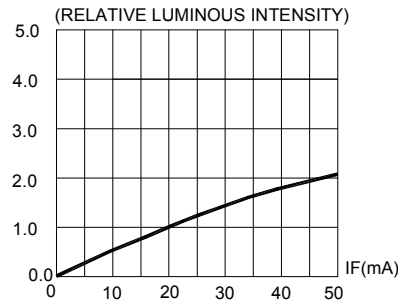

FIG.2 RELATIVE LUMINOUS INTENSITY VS. FORWARD CURRENT

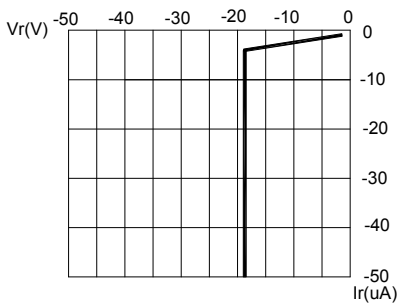

FIG.3 REVERSE CURRENT VS. REVERSE VOLTAGE.

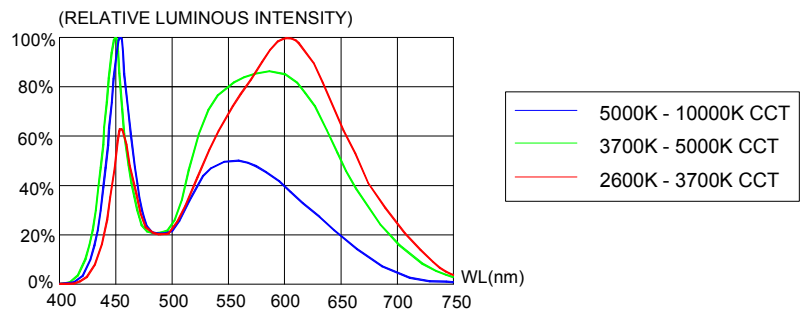

FIG.4 RELATIVE LUMINOUS INTENSITY VS. WAVELENGTH.

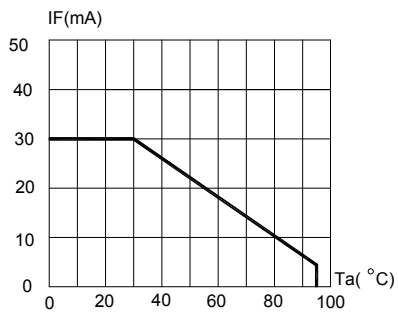

FIG.5 MAXIMUM FORWARD DC CURRENT VS AMBIENT TEMPERATURE ($T_{jmax}=105^{\circ}\text{C}$)

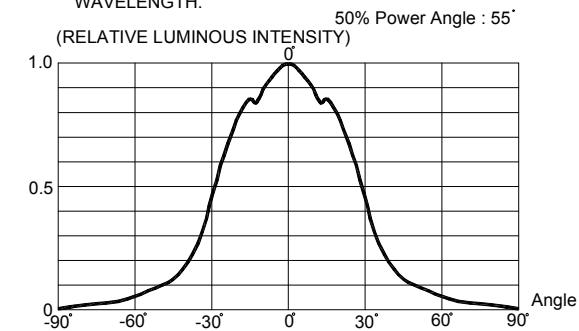

FIG.6 FAR FIELD PATTERN

The above data are collected from statistical figures that do not necessarily correspond to the actual parameters of each single LED. Hence, these data will be changed without further notice.

MECHANICAL DIMENSIONS

All dimensions are in mm. Tolerance is ± 0.25 mm unless otherwise noted.

An epoxy meniscus may extend about 1.5 mm down the leads.

Burr around bottom of epoxy may be 0.5 mm max.

C513A-WSS/MSS:

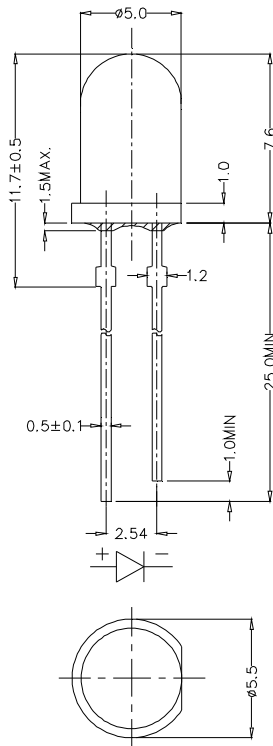

C513A-WSN/MSN:

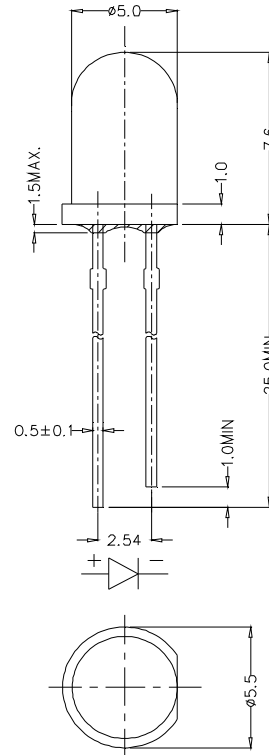

NOTES

RoHS Compliance

The levels of environmentally sensitive, persistent biologically toxic (PBT), persistent organic pollutants (POP), or otherwise restricted materials in this product are below the maximum concentration values (also referred to as the threshold limits) permitted for such substances, or are used in an exempted application, in accordance with EU Directive 2002/95/EC on the restriction of the use of certain hazardous substances in electrical and electronic equipment (RoHS), as amended through April 21, 2006.

Vision Advisory Claim

Users should be cautioned not to stare at the light of this LED product. The bright light can damage the eye.

KIT NUMBER SYSTEM

All dimensions in mm. Cree LED lamps are tested and sorted into performance bins. A bin is specified by ranges of color, forward voltage, and brightness. Sorted LEDs are packaged for shipping in various convenient options. Please refer to the "Cree LED Lamp Packaging Standard" document for more information about shipping and packaging options.

Cree LEDs are sold by order codes in combinations of bins called kits. Order codes are configured in the following manner:

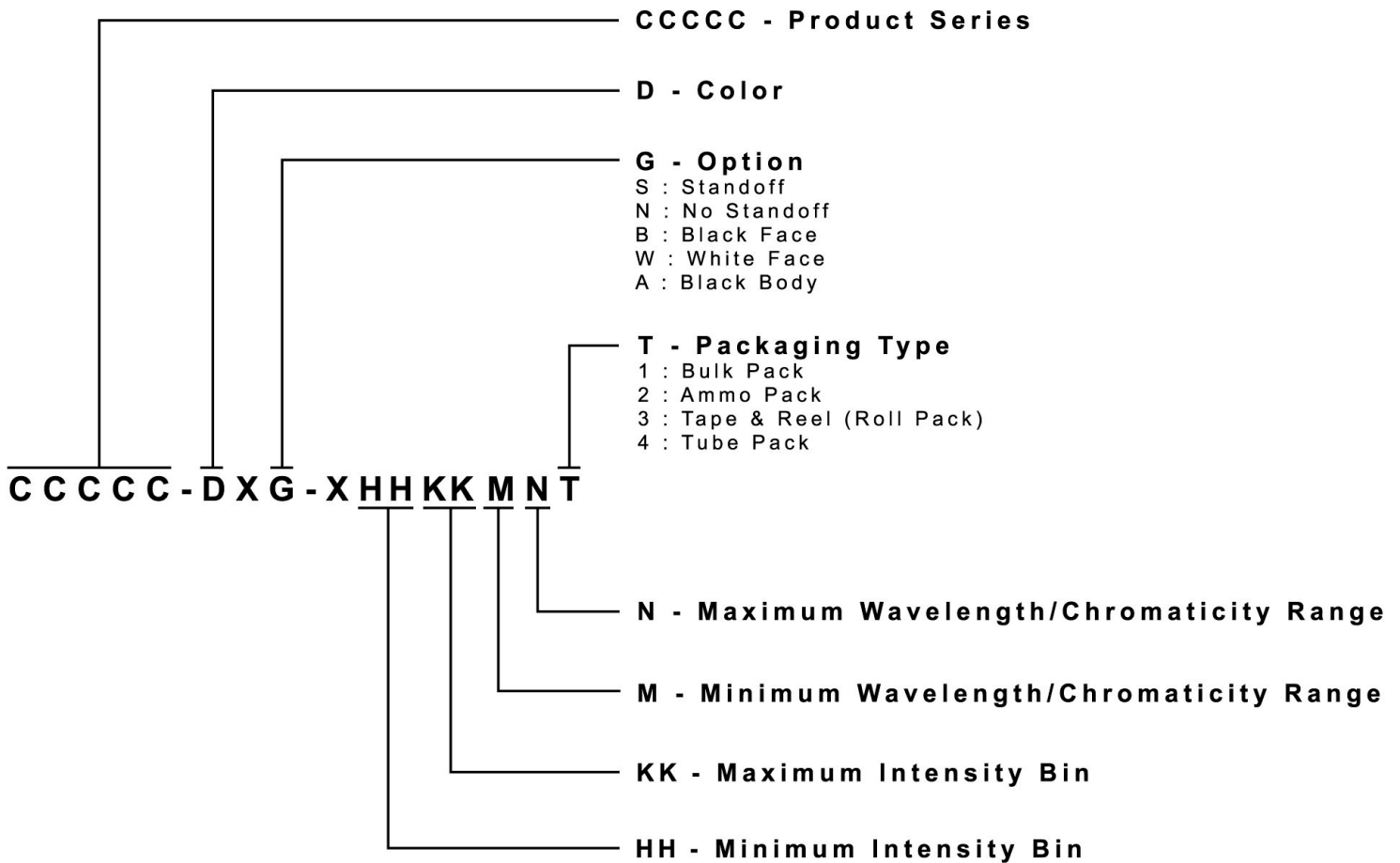

PACKAGING

Features:

- The LEDs are packed in cardboard boxes after packaging in normal or anti-electrostatic bags.
- Cardboard boxes will be used to protect the LEDs from mechanical shock during transportation.
- The boxes are not water resistant, and they must be kept away from water and moisture.
- The Bulk Pack types of packaging.
- Max 500 pcs per bulk and Max 2500 pcs per ammo.

Bulk Pack Packaging Type:

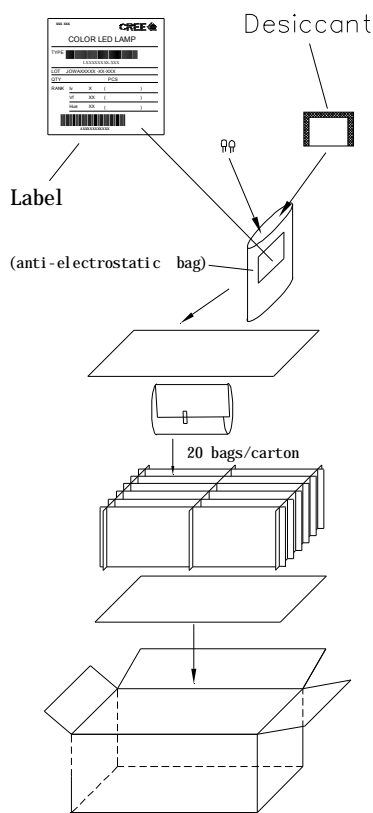

Ammo Pack Packaging Type:

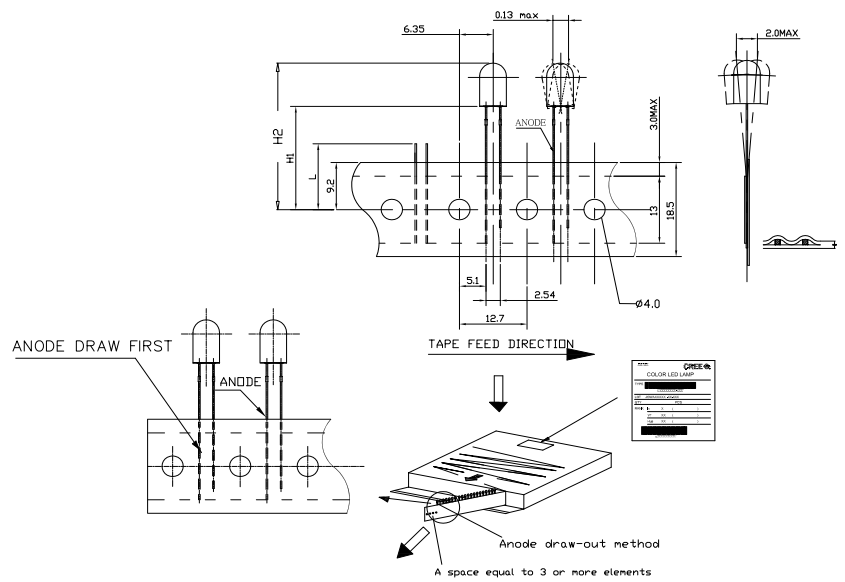

Данный компонент на территории Российской Федерации

Вы можете приобрести в компании MosChip.

Для оперативного оформления запроса Вам необходимо перейти по данной ссылке:

<http://moschip.ru/get-element>

Вы можете разместить у нас заказ для любого Вашего проекта, будь то серийное производство или разработка единичного прибора.

В нашем ассортименте представлены ведущие мировые производители активных и пассивных электронных компонентов.

Нашей специализацией является поставка электронной компонентной базы двойного назначения, продукции таких производителей как XILINX, Intel (ex.ALTERA), Vicor, Microchip, Texas Instruments, Analog Devices, Mini-Circuits, Amphenol, Glenair.

Сотрудничество с глобальными дистрибьюторами электронных компонентов, предоставляет возможность заказывать и получать с международных складов практически любой перечень компонентов в оптимальные для Вас сроки.

На всех этапах разработки и производства наши партнеры могут получить квалифицированную поддержку опытных инженеров.

Система менеджмента качества компании отвечает требованиям в соответствии с ГОСТ Р ИСО 9001, ГОСТ РВ 0015-002 и ЭС РД 009

Офис по работе с юридическими лицами:

105318, г.Москва, ул.Щербаковская д.3, офис 1107, 1118, ДЦ «Щербаковский»

Телефон: +7 495 668-12-70 (многоканальный)

Факс: +7 495 668-12-70 (доб.304)

E-mail: info@moschip.ru

Skype отдела продаж:

moschip.ru

moschip.ru_4

moschip.ru_6

moschip.ru_9