

---

**Features**

- Fast Switching Speed
- Surface Mount Package Ideally Suited for Automated Insertion
- For General Purpose Switching Applications
- High Conductance
- **Lead, Halogen and Antimony Free, RoHS Compliant "Green" Device (Notes 1 and 2)**
- **Qualified to AEC-Q101 Standards for High Reliability**

---

**Mechanical Data**

- Case: SOD-123
- Case Material: Molded Plastic. UL Flammability Classification Rating 94V-0
- Moisture Sensitivity: Level 1 per J-STD-020
- Terminals: Matte Tin Finish annealed over Alloy 42 leadframe (Lead Free Plating). Solderable per MIL-STD-202, Method 208
- Polarity: Cathode Band
- Weight: 0.01 grams (approximate)

SOD-123



Top View

---

**Ordering Information** (Note 3)

Part Number	Case	Packaging
1N4448W-7-F	SOD-123	3000/Tape & Reel

- Notes:
1. No purposefully added lead. Halogen and Antimony Free.
  2. Product manufactured with Data Code V9 (week 33, 2008) and newer are built with Green Molding Compound. Product manufactured prior to Date Code V9 are built with Non-Green Molding Compound and may contain Halogens or Sb<sub>2</sub>O<sub>3</sub> Fire Retardants.
  3. For packaging details, go to our website at <http://www.diodes.com>.

---

**Marking Information**

T5 = Product Type Marking Code  
 YM = Date Code Marking  
 Y = Year (ex: N = 2002)  
 M = Month (ex: 9 = September)

**Date Code Key**

Year	1998	1999	2000	2001	2002	2003	2004	2005	2006	2007	2008	2009	2010	2011	2012	2013	2014	2015
Code	J	K	L	M	N	P	R	S	T	U	V	W	X	Y	Z	A	B	C

Month	Jan	Feb	Mar	Apr	May	Jun	Jul	Aug	Sep	Oct	Nov	Dec
Code	1	2	3	4	5	6	7	8	9	O	N	D

**Maximum Ratings** @T<sub>A</sub> = 25°C unless otherwise specified

Characteristic	Symbol	Value	Unit	
Non-Repetitive Peak Reverse Voltage	V <sub>RM</sub>	100	V	
Peak Repetitive Reverse Voltage	V <sub>RRM</sub>	75	V	
Working Peak Reverse Voltage	V <sub>RWM</sub>			
DC Blocking Voltage	V <sub>R</sub>			
RMS Reverse Voltage	V <sub>R(RMS)</sub>	53	V	
Forward Continuous Current	I <sub>FM</sub>	500	mA	
Average Rectified Output Current	I <sub>O</sub>	250	mA	
Non-Repetitive Peak Forward Surge Current	I <sub>FSM</sub>	@ t = 1.0μs	4.0	A
		@ t = 1.0s	1.0	

**Thermal Characteristics**

Characteristic	Symbol	Value	Unit
Power Dissipation (Note 4)	P <sub>D</sub>	400	mW
Thermal Resistance Junction to Ambient Air (Note 4)	R <sub>θJA</sub>	315	°C/W
Operating and Storage Temperature Range	T <sub>J</sub> , T <sub>STG</sub>	-65 to +150	°C

**Electrical Characteristics** @T<sub>A</sub> = 25°C unless otherwise specified

Characteristic	Symbol	Min	Max	Unit	Test Condition
Reverse Breakdown Voltage (Note 5)	V <sub>(BR)R</sub>	75	—	V	I <sub>R</sub> = 10μA
Forward Voltage	V <sub>FM</sub>	0.62	0.72	V	I <sub>F</sub> = 5.0mA
		—	0.855		I <sub>F</sub> = 10mA
		—	1.0		I <sub>F</sub> = 100mA
		—	1.25		I <sub>F</sub> = 150mA
Peak Reverse Current (Note 5)	I <sub>RM</sub>	—	2.5	μA	V <sub>R</sub> = 75V
		—	50	μA	V <sub>R</sub> = 75V, T <sub>J</sub> = 150°C
		—	30	μA	V <sub>R</sub> = 25V, T <sub>J</sub> = 150°C
		—	25	nA	V <sub>R</sub> = 20V
Total Capacitance	C <sub>T</sub>	—	4.0	pF	V <sub>R</sub> = 0, f = 1.0MHz
Reverse Recovery Time	t <sub>rr</sub>	—	4.0	ns	I <sub>F</sub> = I <sub>R</sub> = 10mA, I <sub>rr</sub> = 0.1 x I <sub>R</sub> , R <sub>L</sub> = 100Ω

Notes: 4. Part mounted on FR-4 PC board with minimum recommended pad layout, which can be found on our website at <http://www.diodes.com>.  
5. Short duration pulse test used to minimize self-heating effect.

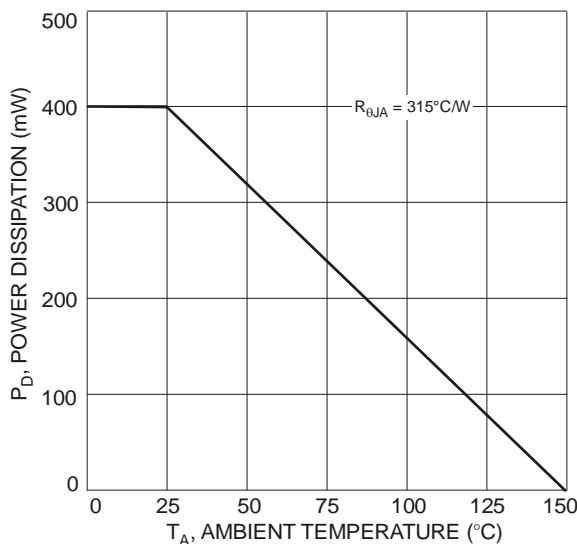

Fig. 1 Power Derating Curve

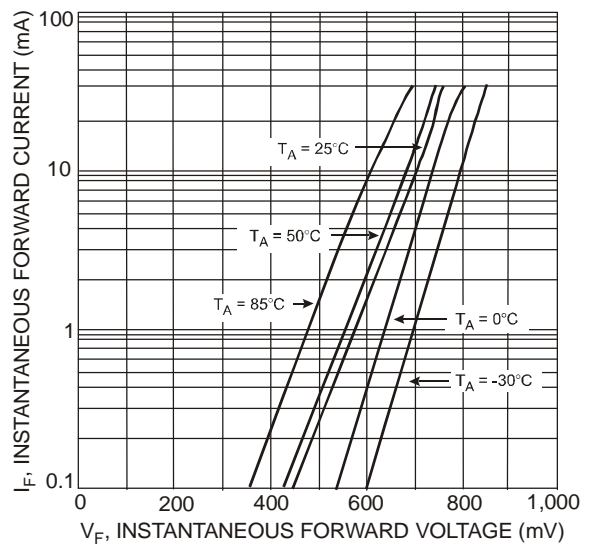

Fig. 2 Typical Forward Characteristics

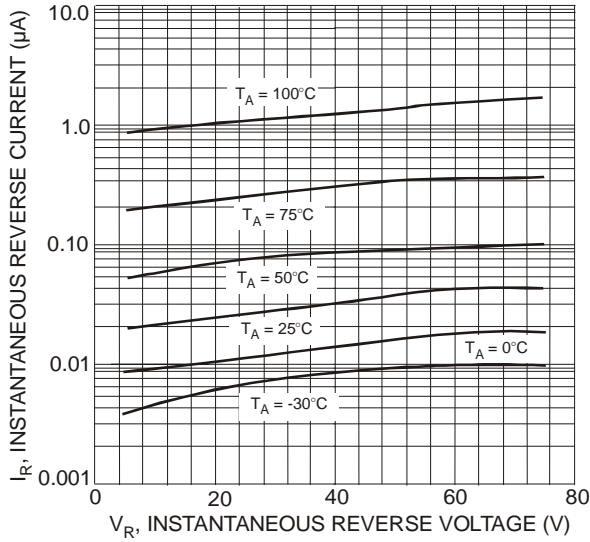

Fig. 3 Typical Reverse Characteristics

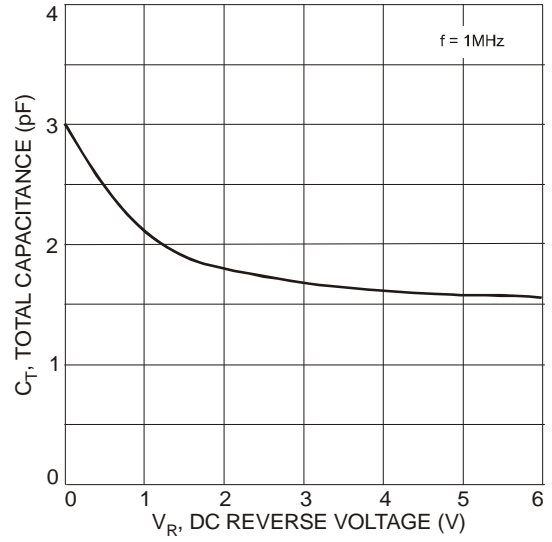

Fig. 4 Total Capacitance vs. Reverse Voltage

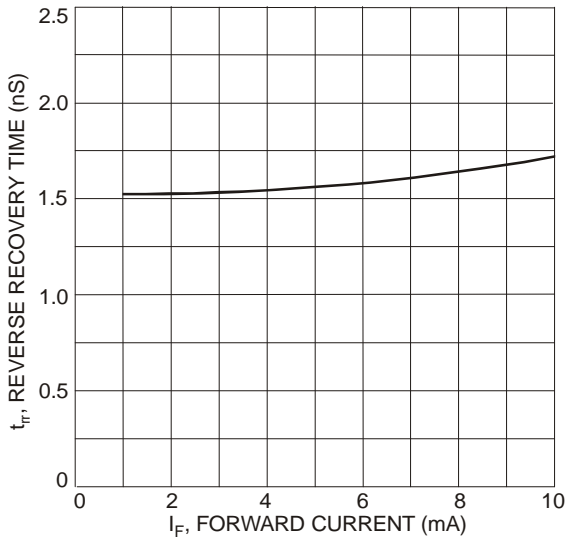
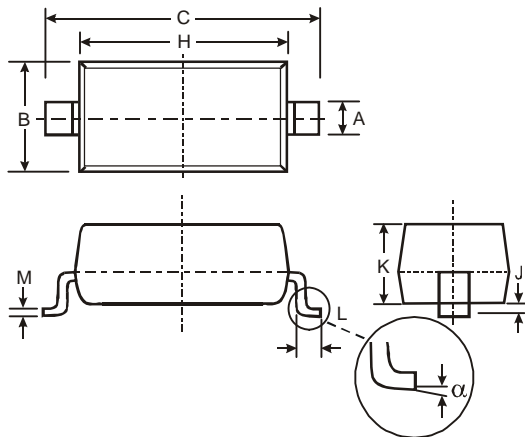

Fig. 5 Reverse Recovery Time vs. Forward Current

**Package Outline Dimensions**



SOD-123		
Dim	Min	Max
A	0.55 Typ	
B	1.40	1.70
C	3.55	3.85
H	2.55	2.85
J	0.00	0.10
K	1.00	1.35
L	0.25	0.40
M	0.10	0.15
$\alpha$	0	8°
<b>All Dimensions in mm</b>		

## Suggested Pad Layout

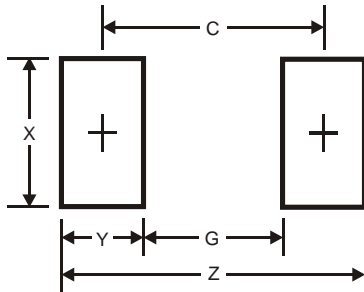

Dimensions	Value (in mm)
Z	4.9
G	2.5
X	0.7
Y	1.2
C	3.7

### IMPORTANT NOTICE

DIODES INCORPORATED MAKES NO WARRANTY OF ANY KIND, EXPRESS OR IMPLIED, WITH REGARDS TO THIS DOCUMENT, INCLUDING, BUT NOT LIMITED TO, THE IMPLIED WARRANTIES OF MERCHANTABILITY AND FITNESS FOR A PARTICULAR PURPOSE (AND THEIR EQUIVALENTS UNDER THE LAWS OF ANY JURISDICTION).

Diodes Incorporated and its subsidiaries reserve the right to make modifications, enhancements, improvements, corrections or other changes without further notice to this document and any product described herein. Diodes Incorporated does not assume any liability arising out of the application or use of this document or any product described herein; neither does Diodes Incorporated convey any license under its patent or trademark rights, nor the rights of others. Any Customer or user of this document or products described herein in such applications shall assume all risks of such use and will agree to hold Diodes Incorporated and all the companies whose products are represented on Diodes Incorporated website, harmless against all damages.

Diodes Incorporated does not warrant or accept any liability whatsoever in respect of any products purchased through unauthorized sales channel. Should Customers purchase or use Diodes Incorporated products for any unintended or unauthorized application, Customers shall indemnify and hold Diodes Incorporated and its representatives harmless against all claims, damages, expenses, and attorney fees arising out of, directly or indirectly, any claim of personal injury or death associated with such unintended or unauthorized application.

Products described herein may be covered by one or more United States, international or foreign patents pending. Product names and markings noted herein may also be covered by one or more United States, international or foreign trademarks.

### LIFE SUPPORT

Diodes Incorporated products are specifically not authorized for use as critical components in life support devices or systems without the express written approval of the Chief Executive Officer of Diodes Incorporated. As used herein:

A. Life support devices or systems are devices or systems which:

1. are intended to implant into the body, or
2. support or sustain life and whose failure to perform when properly used in accordance with instructions for use provided in the labeling can be reasonably expected to result in significant injury to the user.

B. A critical component is any component in a life support device or system whose failure to perform can be reasonably expected to cause the failure of the life support device or to affect its safety or effectiveness.

Customers represent that they have all necessary expertise in the safety and regulatory ramifications of their life support devices or systems, and acknowledge and agree that they are solely responsible for all legal, regulatory and safety-related requirements concerning their products and any use of Diodes Incorporated products in such safety-critical, life support devices or systems, notwithstanding any devices- or systems-related information or support that may be provided by Diodes Incorporated. Further, Customers must fully indemnify Diodes Incorporated and its representatives against any damages arising out of the use of Diodes Incorporated products in such safety-critical, life support devices or systems.

Copyright © 2010, Diodes Incorporated

[www.diodes.com](http://www.diodes.com)

## Данный компонент на территории Российской Федерации

### Вы можете приобрести в компании MosChip.

Для оперативного оформления запроса Вам необходимо перейти по данной ссылке:

<http://moschip.ru/get-element>

Вы можете разместить у нас заказ для любого Вашего проекта, будь то серийное производство или разработка единичного прибора.

В нашем ассортименте представлены ведущие мировые производители активных и пассивных электронных компонентов.

Нашей специализацией является поставка электронной компонентной базы двойного назначения, продукции таких производителей как XILINX, Intel (ex.ALTERA), Vicor, Microchip, Texas Instruments, Analog Devices, Mini-Circuits, Amphenol, Glenair.

Сотрудничество с глобальными дистрибьюторами электронных компонентов, предоставляет возможность заказывать и получать с международных складов практически любой перечень компонентов в оптимальные для Вас сроки.

На всех этапах разработки и производства наши партнеры могут получить квалифицированную поддержку опытных инженеров.

Система менеджмента качества компании отвечает требованиям в соответствии с ГОСТ Р ИСО 9001, ГОСТ РВ 0015-002 и ЭС РД 009

### Офис по работе с юридическими лицами:

105318, г.Москва, ул.Щербаковская д.3, офис 1107, 1118, ДЦ «Щербаковский»

Телефон: +7 495 668-12-70 (многоканальный)

Факс: +7 495 668-12-70 (доб.304)

E-mail: [info@moschip.ru](mailto:info@moschip.ru)

Skype отдела продаж:

moschip.ru

moschip.ru\_4

moschip.ru\_6

moschip.ru\_9