

XPT IGBT Module

tentative

$$V_{CES} = 2 \times 650V$$

$$I_{C25} = 720A$$

$$V_{CE(sat)} = 1.65V$$

Phase leg + free wheeling Diodes + NTC

Part number

MIXA600PF650TSF

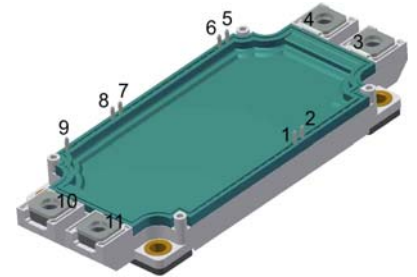

Backside: isolated

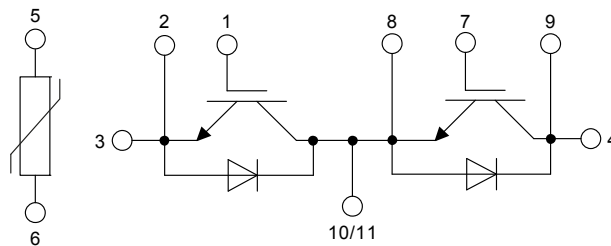
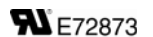

Features / Advantages:

- High level of integration - only one power semiconductor module required for the whole drive
- Rugged XPT design (Xtreme light Punch Through) results in:
 - short circuit rated for 10 μ sec.
 - very low gate charge
 - low EMI
 - square RBSOA @ 3x I_c
- Thin wafer technology combined with the XPT design results in a competitive low $V_{CE(sat)}$
- Temperature sense included
- SONIC™ diode
 - fast and soft reverse recovery
 - low operating forward voltage

Applications:

- AC motor drives
- Pumps, Fans
- Air-conditioning system
- Inverter and power supplies
- UPS

Package: SimBus F

- Isolation Voltage: 3000V~
- Industry standard outline
- RoHS compliant
- Soldering pins for PCB mounting
- Height: 17 mm
- Base plate: Copper internally DCB isolated
- Advanced power cycling

IGBT				Ratings			
Symbol	Definition	Conditions	min.	typ.	max.	Unit	
V_{CES}	collector emitter voltage	$T_{VJ} = 25^{\circ}C$			650	V	
V_{GES}	max. DC gate voltage				± 20	V	
V_{GEM}	max. transient gate emitter voltage				± 30	V	
I_{C25}	collector current	$T_C = 25^{\circ}C$			720	A	
I_{C80}		$T_C = 80^{\circ}C$			490	A	
P_{tot}	total power dissipation	$T_C = 25^{\circ}C$			1750	W	
$V_{CE(sat)}$	collector emitter saturation voltage	$I_C = 600A; V_{GE} = 15V$		1.65	1.8	V	
				1.85		V	
$V_{GE(th)}$	gate emitter threshold voltage	$I_C = 9.6mA; V_{GE} = V_{CE}$	4	4.8	5.5	V	
I_{CES}	collector emitter leakage current	$V_{CE} = V_{CES}; V_{GE} = 0V$			1.8	mA	
				2		mA	
I_{GES}	gate emitter leakage current	$V_{GE} = \pm 20V$			1.5	μA	
$Q_{G(on)}$	total gate charge	$V_{CE} = 300V; V_{GE} = 15V; I_C = 600A$		840		nC	
$t_{d(on)}$	turn-on delay time	inductive load $V_{CE} = 300V; I_C = 600A$ $V_{GE} = \pm 15V; R_G = 1.3\Omega$		30		ns	
t_r	current rise time		$T_{VJ} = 150^{\circ}C$	50		ns	
$t_{d(off)}$	turn-off delay time		100		ns		
t_f	current fall time		40		ns		
E_{on}	turn-on energy per pulse		6		mJ		
E_{off}	turn-off energy per pulse		22.8		mJ		
RBSOA	reverse bias safe operating area	$V_{GE} = \pm 15V; R_G = 1.3\Omega$					
I_{CM}		$V_{CEmax} = 650V$			1200	A	
SCSOA	short circuit safe operating area	$V_{CEmax} = 650V$					
t_{sc}	short circuit duration	$V_{CE} = 360V; V_{GE} = \pm 15V$			10	μs	
I_{sc}	short circuit current	$R_G = 1.3\Omega; \text{non-repetitive}$		2400		A	
R_{thJC}	thermal resistance junction to case				0.085	K/W	
R_{thCH}	thermal resistance case to heatsink				0.05	K/W	
Diode							
V_{RRM}	max. repetitive reverse voltage	$T_{VJ} = 25^{\circ}C$			650	V	
I_{F25}	forward current	$T_C = 25^{\circ}C$			490	A	
I_{F80}		$T_C = 80^{\circ}C$			340	A	
V_F	forward voltage	$I_F = 600A$			1.90	V	
				1.70		V	
I_R	reverse current	$V_R = V_{RRM}$			*	mA	
	* not applicable, see Ices value above				*	mA	
Q_{rr}	reverse recovery charge	$V_R = 300V$ $-di_F/dt = 0A/\mu s$ $I_F = 600A; V_{GE} = 0V$		tbd		μC	
I_{RM}	max. reverse recovery current		$T_{VJ} = 125^{\circ}C$	tbd		A	
t_{rr}	reverse recovery time		tbd		ns		
E_{rec}	reverse recovery energy		tbd		mJ		
R_{thJC}	thermal resistance junction to case				0.095	K/W	
R_{thCH}	thermal resistance case to heatsink				0.04	K/W	

Package SimBus F			Ratings			
Symbol	Definition	Conditions	min.	typ.	max.	Unit
I_{RMS}	RMS current	per terminal				A
T_{stg}	storage temperature		-40		125	°C
T_{VJ}	virtual junction temperature		-40		175	°C
Weight				350		g
M_D	mounting torque		3		6	Nm
M_T	terminal torque		3		6	Nm
$d_{Spp/App}$	creepage distance on surface striking distance through air	terminal to terminal	12.7			mm
$d_{Spb/Apb}$		terminal to backside	10.0			mm
V_{ISOL}	isolation voltage	t = 1 second	3000			V
		t = 1 minute	2500			V
$R_{pin-chip}$	resistance pin to chip	$V = V_{CEsat} + 2 \cdot R \cdot I_C$ resp. $V = V_F + 2 \cdot R \cdot I_F$		0.65		mΩ

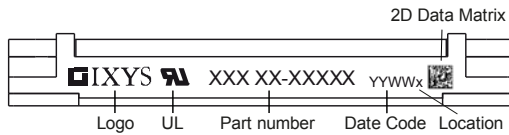

Part number

M = Module
 I = IGBT
 X = XPT IGBT
 A = Gen 1 / std
 600 = Current Rating [A]
 PF = Phase leg + free wheeling Diodes
 650 = Reverse Voltage [V]
 T = Thermistor \ Temperature sensor
 SF = SimBus F

Ordering	Part Number	Marking on Product	Delivery Mode	Quantity	Code No.
Standard	MIXA600PF650TSF	MIXA600PF650TSF	Box	3	513794

Temperature Sensor NTC

Symbol	Definition	Conditions	min.	typ.	max.	Unit
R_{25}	resistance	$T_{VJ} = 25^\circ$	4.75	5	5.25	kΩ
$B_{25/50}$	temperature coefficient			3375		K

Equivalent Circuits for Simulation

* on die level

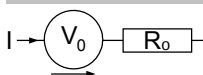
 $T_{VJ} = 175^\circ\text{C}$

		IGBT	Diode	
$V_{0\ max}$	threshold voltage	1.1	1.21	V
$R_{0\ max}$	slope resistance *	1.8	1	mΩ

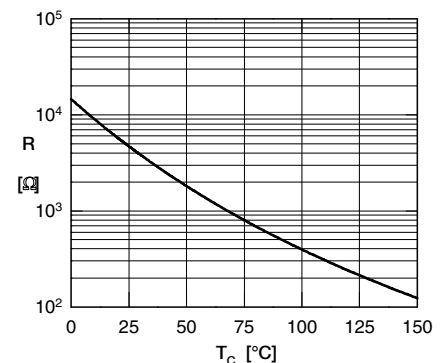

Typ. NTC resistance vs. temperature

Outlines SimBus F

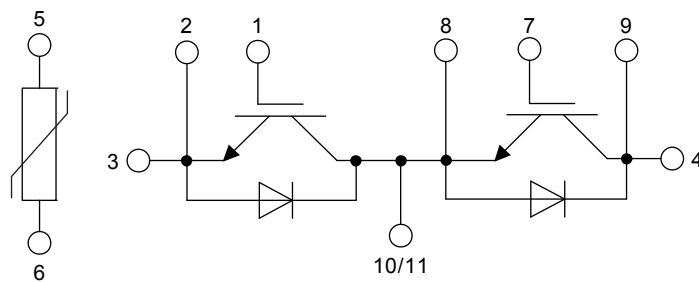
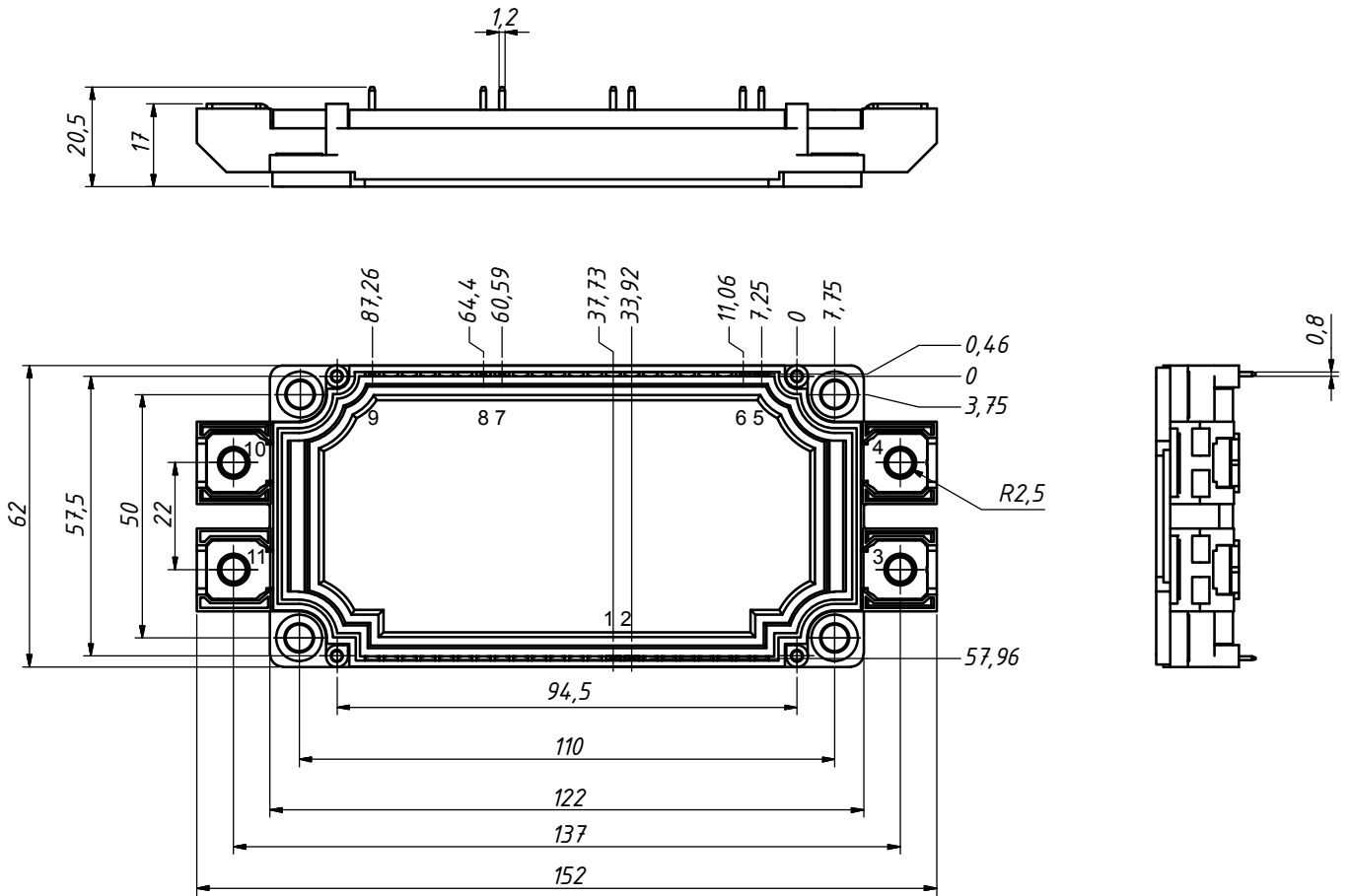

Данный компонент на территории Российской Федерации

Вы можете приобрести в компании MosChip.

Для оперативного оформления запроса Вам необходимо перейти по данной ссылке:

<http://moschip.ru/get-element>

Вы можете разместить у нас заказ для любого Вашего проекта, будь то серийное производство или разработка единичного прибора.

В нашем ассортименте представлены ведущие мировые производители активных и пассивных электронных компонентов.

Нашей специализацией является поставка электронной компонентной базы двойного назначения, продукции таких производителей как XILINX, Intel (ex.ALTERA), Vicor, Microchip, Texas Instruments, Analog Devices, Mini-Circuits, Amphenol, Glenair.

Сотрудничество с глобальными дистрибьюторами электронных компонентов, предоставляет возможность заказывать и получать с международных складов практически любой перечень компонентов в оптимальные для Вас сроки.

На всех этапах разработки и производства наши партнеры могут получить квалифицированную поддержку опытных инженеров.

Система менеджмента качества компании отвечает требованиям в соответствии с ГОСТ Р ИСО 9001, ГОСТ РВ 0015-002 и ЭС РД 009

Офис по работе с юридическими лицами:

105318, г.Москва, ул.Щербаковская д.3, офис 1107, 1118, ДЦ «Щербаковский»

Телефон: +7 495 668-12-70 (многоканальный)

Факс: +7 495 668-12-70 (доб.304)

E-mail: info@moschip.ru

Skype отдела продаж:

moschip.ru

moschip.ru_4

moschip.ru_6

moschip.ru_9