

### Product Overview

The TQP7M9103 is a high linearity driver amplifier in industry standard, RoHS compliant, SOT-89 surface mount package. This InGaP/GaAs HBT delivers high performance across a broad range of frequencies while achieving +45 dBm OIP3 and +29.5 dBm P1dB while only consuming 235 mA quiescent current. All devices are 100% RF and DC tested.

The TQP7M9103 incorporates on-chip features that differentiate it from other products in the market. The amplifier integrates an on-chip DC over-voltage and RF over-drive protection. This protects the amplifier from electrical DC voltage surges and high input RF input power levels that may occur in a system.

The TQP7M9103 is targeted for use as a driver amplifier in wireless infrastructure where high linearity, medium power, and high efficiency are required. The device an excellent candidate for transceiver line cards and high power amplifiers in current and next generation multi-carrier 3G/4G base stations.



3-pin SOT-89 Package

### Key Features

- 400 – 4000 MHz
- +29.5 dBm P1dB
- +45 dBm Output IP3
- 16.5 dB Gain at 2140 MHz
- +5 V Single Supply, 235 mA Current
- Internal RF Overdrive Protection
- Internal DC Overvoltage Protection
- On chip ESD Protection
- RF Power Handling 10:1 VSWR,  $V_{CC}=+5V$ , 2.14 GHz  
Pout=+29.5 dBm CW  
Pout=+20 dBm WCDMA
- SOT-89 Package

### Functional Block Diagram

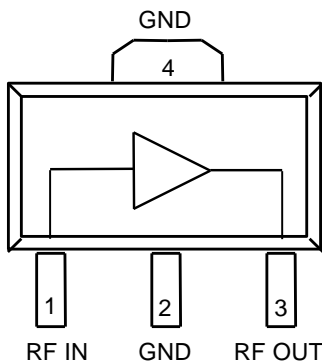

Top View

### Applications

- Repeaters
- BTS Transceivers
- BTS High Power Amplifiers
- CDMA / WCDMA / LTE
- General Purpose Wireless

### Ordering Information

Part No.	Description
TQP7M9103	1 W High Linearity Amplifier
TQP7M9103-PCB900	920–960 MHz Evaluation Board
TQP7M9103-PCB2140	2.11–2.17 GHz Evaluation Board
TQP7M9103-PCB2600	2.62 – 2.69 GHz Evaluation Board

Standard T/R size = 1000 pieces on a 7" reel

## Absolute Maximum Ratings

Parameter	Rating
Storage Temperature	-65 to 150 °C
RF Input Power, CW, 50 Ω, T=+25 °C	+30 dBm
Device Voltage (V <sub>CC</sub> )	+8 V

Operation of this device outside the parameter ranges given above may cause permanent damage.

## Recommended Operating Conditions

Parameter	Min	Typ	Max	Units
Device Voltage (V <sub>CC</sub> )		+5.0	+5.25	V
T <sub>CASE</sub>	-40		+105	°C
T <sub>j</sub> for >10 <sup>6</sup> hours MTTF			+170	°C

Electrical specifications are measured at specified test conditions. Specifications are not guaranteed over all recommended operating conditions.

## Electrical Specifications

Test conditions unless otherwise noted: V<sub>CC</sub> = +5.0 V, Temp = +25 °C

Parameter	Conditions	Min	Typ	Max	Units
Operational Frequency Range		400		4000	MHz
Test Frequency			2140		MHz
Gain		14.7	16.6	17.7	dB
Input Return Loss			12.0		dB
Output Return Loss			15.0		dB
Output P1dB		+28.5	+29.5		dBm
Output IP3	P <sub>out</sub> = +15 dBm/tone, Δf = 1 MHz	+42.5	+45		dBm
WCDMA Output Power	-50 dBc ACLR <sup>(1)</sup>		+20		dBm
Noise Figure			4.4		dB
Quiescent Current, I <sub>CO</sub>		210	235	260	mA
Thermal Resistance, θ <sub>jc</sub>	Module (junction to case)			35.6	°C/W

Notes:

1. ACLR Test set-up: 3GPP WCDMA, TM1+64 DPCH, +5 MHz offset, PAR = 10.2 dB at 0.01% Prob.

**Device Characterization Data**

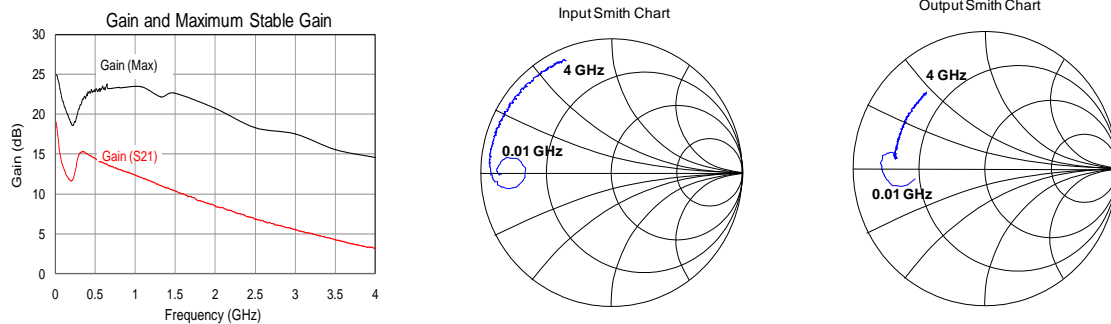

Note: The gain for the unmatched device in 50 ohm system is shown as the trace in red color, [Gain (S21)]. For a tuned circuit for a particular frequency, its expected gain will be higher, up to the maximum stable gain. The maximum stable gain is shown as the black trace, [Gain (Max)]. The impedance plots are shown from 0.01– 4 GHz.

**S-Parameters**

Test Conditions:  $V_{CC}=+5\text{ V}$ ,  $I_{CQ}=235\text{ mA}$ ,  $T=+25^{\circ}\text{C}$ , unmatched 50 ohm system, calibrated to device leads

Freq (MHz)	S11 (dB)	S11 (ang)	S21 (dB)	S21 (ang)	S12 (dB)	S12 (ang)	S22 (dB)	S22 (ang)
50	-1.05	179.35	15.75	154.01	-35.54	-2.51	-2.94	-171.04
100	-1.15	176.19	13.33	155.93	-35.54	-9.63	-2.28	-176.20
200	-2.07	171.50	11.63	168.26	-37.45	-27.07	-2.00	176.45
400	-1.01	-176.54	15.01	153.46	-36.02	22.73	-3.38	172.64
600	-0.61	173.92	13.87	137.55	-35.08	6.61	-3.21	171.33
800	-0.59	169.36	13.05	125.26	-34.89	0.27	-3.18	168.76
1000	-0.62	164.62	12.35	114.05	-34.56	-4.24	-3.13	166.33
1200	-0.62	160.93	11.51	103.77	-34.60	-7.64	-3.21	164.22
1400	-0.67	156.67	10.73	94.67	-34.79	-12.27	-3.18	162.12
1600	-0.64	153.26	10.00	86.25	-34.75	-15.00	-3.21	159.50
1800	-0.75	149.43	9.12	78.19	-34.75	-17.78	-3.25	156.37
2000	-0.64	145.77	8.50	70.63	-34.81	-20.08	-3.09	154.32
2200	-0.62	142.62	7.90	63.72	-34.51	-23.77	-3.24	151.96
2400	-0.77	139.07	7.16	57.32	-34.72	-26.63	-3.10	148.69
2600	-0.66	135.41	6.58	51.13	-34.60	-29.04	-3.07	147.12
2800	-0.73	132.81	6.04	45.43	-34.65	-33.24	-3.16	144.43
3000	-0.69	128.99	5.51	39.41	-34.51	-33.49	-3.09	141.32
3200	-0.74	125.72	5.01	33.18	-34.65	-34.26	-3.12	138.96
3400	-0.74	122.13	4.52	27.44	-34.60	-37.56	-3.09	136.12
3600	-0.72	119.18	4.02	22.42	-34.56	-43.68	-3.13	133.54
3800	-0.77	116.00	3.52	16.74	-34.37	-44.96	-3.04	130.91
4000	-0.80	113.01	3.15	11.74	-34.33	-46.26	-2.96	128.69

**Evaluation Board, 615 – 655 MHz Reference Design**

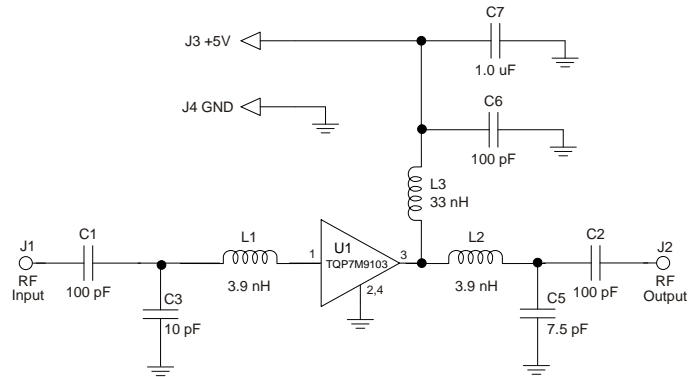
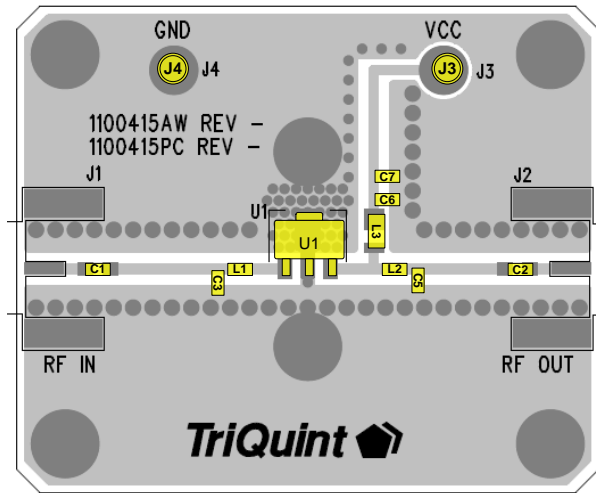

**Notes:**

1. Components shown on the silkscreen but not on the schematic are not used.
2. 0 Ω resistor can be replaced with copper trace in the target application layout.
3. All components are of 0603 size unless stated on the schematic.
4. The recommended component values are dependent upon the frequency of operation.
5. Critical component placement locations:
  - Distance between U1 Pin 1 Pad left edge to L1 (right edge): 55 mil
  - Distance between U1 Pin 1 Pad left edge to C3 (right edge): 130 mil
  - Distance between U1 Pin 3 Pad right edge to C5 (left edge): 160 mil
  - Distance between U1 Pin 3 Pad right edge to L2 (left edge): 85 mil

**Bill of Material, 615 – 655 MHz**

Reference Des.	Value	Description	Manuf.	Part Number
n/a	n/a	Printed Circuit Board	Qorvo	
U1	n/a	1 W High Linearity Amplifier	Qorvo	TQP7M9103
C3	10 pF	CAP, 0603, ± 0.05 pF, 50V, NPO	AVX	06032U100J
C5	7.5 pF	CAP, 0603, ± 0.05 pF, 50V, NPO	AVX	06032U7R5B
C1, C2, C6	100 pF	CAP, 0603, 5%, 50V, NPO/COG	various	
C7	1.0 uF	CAP, 0603, 10%, X5R, 10V	various	
L1, L2	3.9 nH	IND, 0603, +/-0.3nH	TOKO	LL1608-FSL3N9S
L3	33 nH	IND, 0805, 5%, Wirewound	Coilcraft	0805CS-330XJL

## Typical Performance, 615 – 655 MHz

Test conditions unless otherwise noted:  $V_{CC} = +5\text{ V}$ ,  $I_{CQ} = 235\text{ mA}$ ,  $Temp. = +25\text{ }^\circ\text{C}$

Parameter	Conditions	Typical Value			Units
Frequency		617	635	652	MHz
Gain		20.9	20.9	20.8	dB
Input Return Loss		9.5	10	10	dB
Output Return Loss		20	19	18	dB
Output P1dB		+29.3	+29.5	+29.7	dBm
OIP3	$P_{out} = +19\text{ dBm / tone, } \Delta f = 1\text{ MHz}$	+47.7	+46.2	+44.2	dBm
WCDMA Channel Power <sup>(1)</sup>	$ACLR = -50\text{ dBc}$	+19.3	+19.2	+18.3	dBm

Notes:

- 1C 20MHz LTE signal,  $PAR = 9.5\text{ dB}$

## Performance Plots, 615 – 655 MHz

Test conditions unless otherwise noted:  $V_{CC} = +5\text{ V}$ ,  $I_{CQ} = 235\text{ mA}$ ,  $Temp. = +25\text{ }^\circ\text{C}$

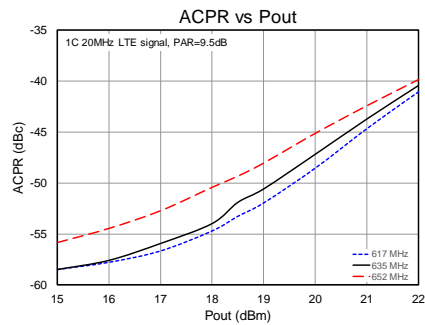
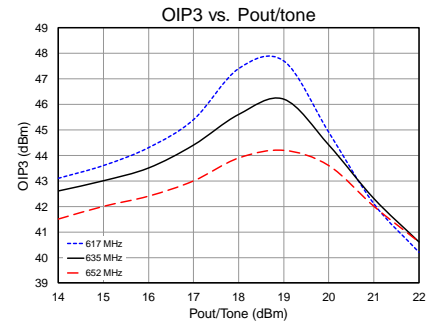
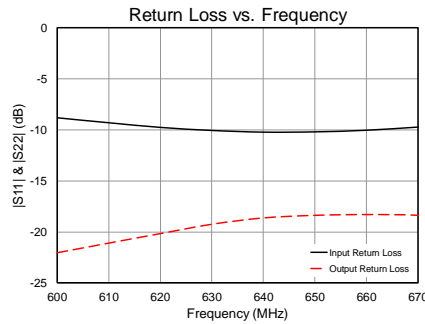
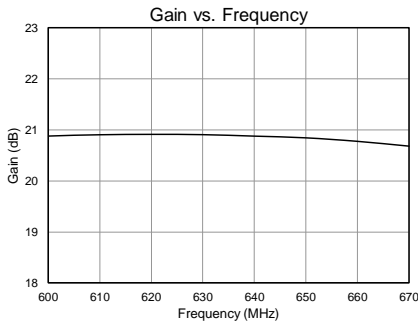

**Evaluation Board, 758 – 875 MHz Reference Design**

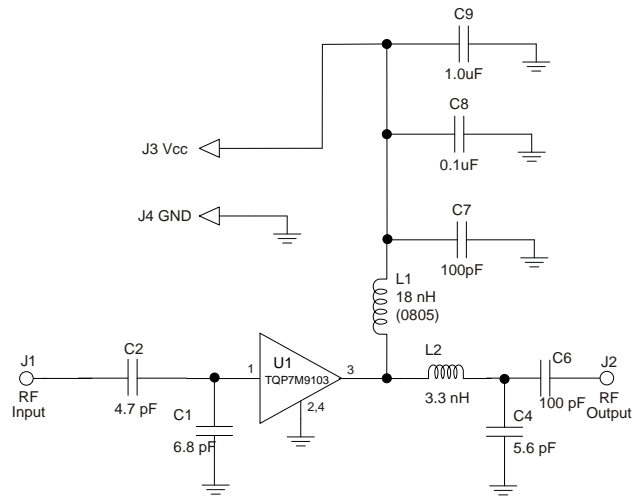
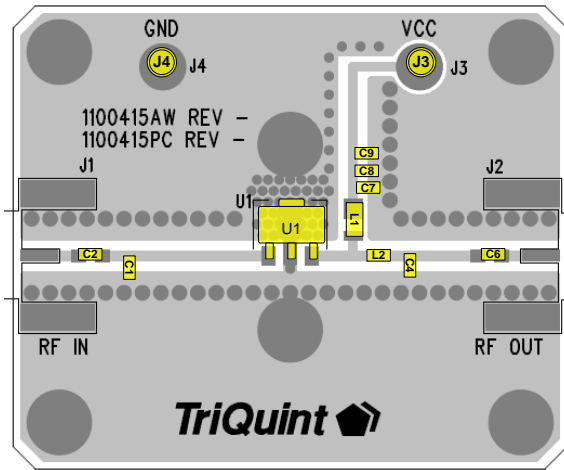

**Notes:**

- 6. Components shown on the silkscreen but not on the schematic are not used.
- 7. 0 Ω resistor can be replaced with copper trace in the target application layout.
- 8. All components are of 0603 size unless stated on the schematic.
- 9. The recommended component values are dependent upon the frequency of operation.
- 10. Critical component placement locations:
  - Distance between U1 Pin 1 Pad left edge to C1 (right edge): 362 mil
  - Distance between U1 Pin 3 Pad right edge to L2 (left edge): 150 mil
  - Distance between U1 Pin 3 Pad right edge to C4 (left edge): 230 mil

**Bill of Material, 758 – 875 MHz**

Reference Des.	Value	Description	Manuf.	Part Number
n/a	n/a	Printed Circuit Board	Qorvo	
U1	n/a	1 W High Linearity Amplifier	Qorvo	TQP7M9103
C1	6.8 pF	CAP, 0603, ± 0.05 pF, 50V, NPO	AVX	06032U6R8BAT2A
C2	4.7 pF	CAP, 0603, ± 0.05 pF, 50V, NPO	AVX	06032U4R7BAT2A
C6, C7	100 pF	CAP, 0603, 5%, 50V, NPO/COG	various	
C9	1.0 uF	CAP, 0603, 10%, X5R , 10V	various	
C4	5.6 pF	CAP, 0603, ± 0.05 pF, 50V, NPO	AVX	06032U5R6BAT2A
C8	0.1 uF	CAP, chip, 0603	Various	
L2	3.3 nH	IND, 0805, 5%, Ceramic	TOKO	LL1608-FSL3N3S
L1	18 nH	IND, 0805, 5%, Wirewound	Coilcraft	0805CS-180XJL

## Typical Performance, 758 – 875 MHz

Test conditions unless otherwise noted:  $V_{CC} = +5\text{ V}$ ,  $I_{CQ} = 235\text{ mA}$ ,  $Temp. = +25\text{ }^\circ\text{C}$

Parameter	Conditions	Typical Value			Units
Frequency		758	803	875	MHz
Gain		21	21.5	21.3	dB
Input Return Loss		7.7	11.7	11.5	dB
Output Return Loss		16.5	17	30	dB
Output P1dB		+29.2	+29.5	+29	dBm
OIP3	$P_{out} = +19\text{ dBm / tone, } \Delta f = 1\text{ MHz}$	+46.5	+43.7	+41.7	dBm
WCDMA Channel Power <sup>(1)</sup>	ACLR = -50 dBc	+19.5	+19.8	+19.2	dBm

Notes:

- 3GPP WCDMA, TM1+64 DPCH, +5 MHz offset, PAR = 10.2 dB at 0.01% Prob.

## Performance Plots, 758 – 875 MHz

Test conditions unless otherwise noted:  $V_{CC} = +5\text{ V}$ ,  $I_{CQ} = 235\text{ mA}$ ,  $Temp. = +25\text{ }^\circ\text{C}$

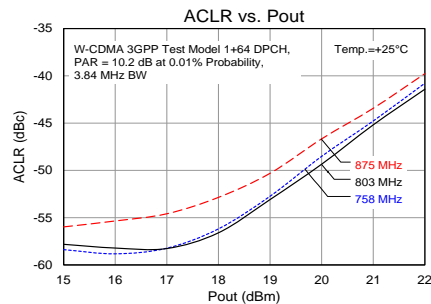
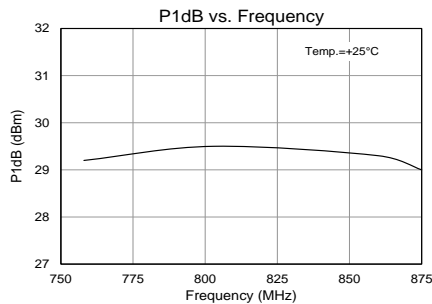
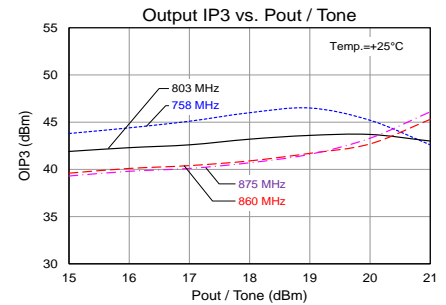
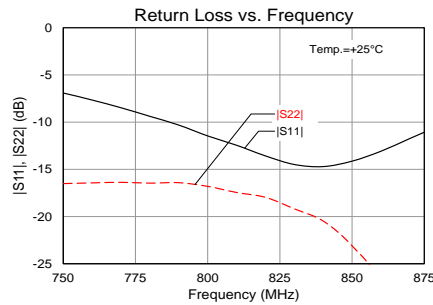
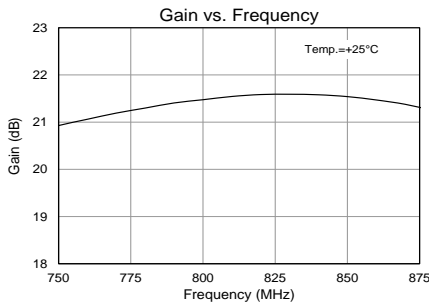

## Typical Performance, 869 – 894 MHz

Test conditions unless otherwise noted:  $V_{CC} = +5\text{ V}$ ,  $I_{CQ} = 235\text{ mA}$ ,  $Temp. = +25\text{ }^{\circ}\text{C}$

Parameter	Conditions	Typical Value			Units
Frequency		869	880	894	MHz
Gain		20.8	20.8	20.8	dB
Input Return Loss		17.5	18.7	17.2	dB
Output Return Loss		14.3	14.4	14.5	dB
Output P1dB		+29.2	+29.3	+29.4	dBm
OIP3	$P_{out} = +19\text{ dBm} / \text{tone}$ , $\Delta f = 1\text{ MHz}$	+43.6	+42.9	+42.3	dBm
WCDMA Channel Power <sup>(1)</sup>	ACLR = -50 dBc	+19.7	+19.7	+19.7	dBm

Notes:

- 3GPP WCDMA, TM1+64 DPCH, +5 MHz offset, PAR = 10.2 dB at 0.01% Prob.

## RF Performance Plots, 869 – 894 MHz

Test conditions unless otherwise noted:  $V_{CC} = +5\text{ V}$ ,  $I_{CQ} = 235\text{ mA}$ ,  $Temp. = +25\text{ }^{\circ}\text{C}$

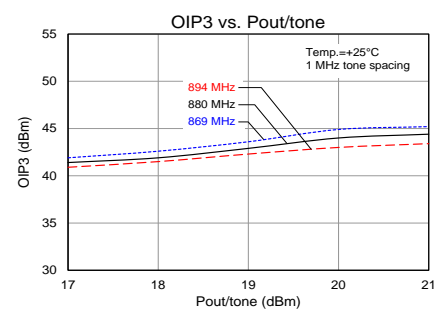
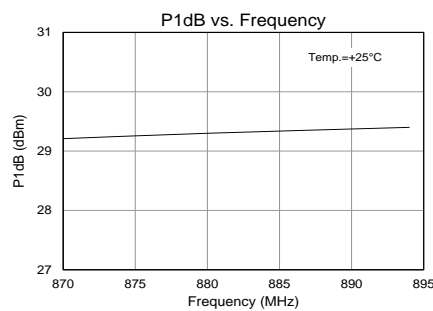
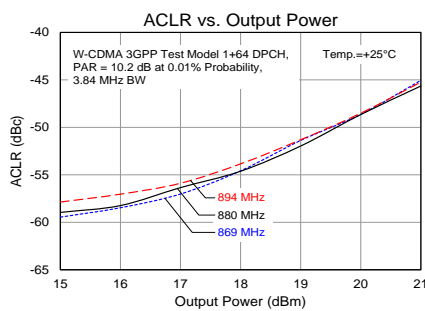
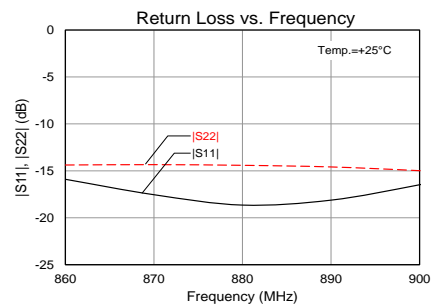
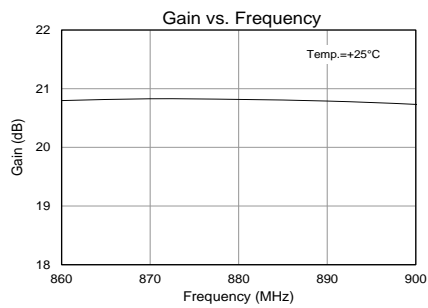



**Evaluation Board, TQP7M9103-PCB900**

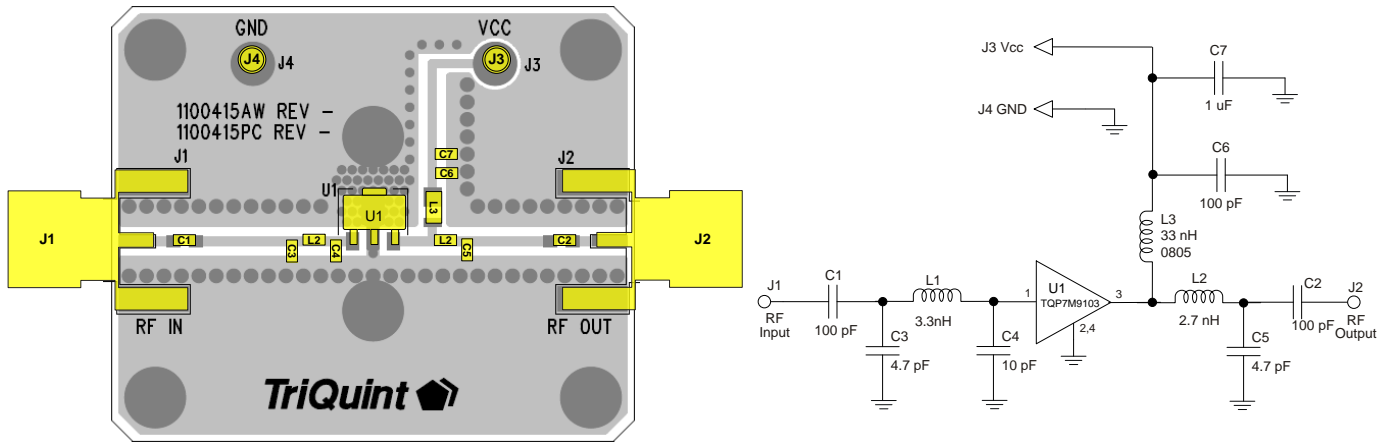

**Notes:**

11. All components are of 0603 size unless stated on the schematic.
12. The recommended component values are dependent upon the frequency of operation.
13. Critical component placement locations:
  - Distance between U1 Pin 1 Pad to C4 (right edge): 20 mil
  - Distance between U1 Pin 1 Pad to C3 (right edge): 130 mil
  - Distance between U1 Pin 3 Pad to C5 (left edge): 158 mil
  - Distance between U1 Pin 3 Pad to L2 (left edge): 85 mil

**Bill of Material, TQP7M9103-PCB900**

Reference Des.	Value	Description	Manuf.	Part Number
U1	n/a	1 W High Linearity Amplifier	Qorvo	TQP7M9103
C3, C5	4.7 pF	CAP, 0603, ± 0.05 pF, 50V, NPO	AVX	06032U4R7BAT2A
C4	10 pF	CAP, 0603, ± 0.05 pF, 50V, NPO	AVX	06035A100JAT2A
C1, C2, C6	100 pF	CAP, 0603, 5%, 50V, NPO/COG	various	
C7	1.0 uF	CAP, 0603, 10%, X5R, 10V	various	
L1	3.3 nH	IND, 0603, +/-0.3nH	TOKO	LL1608-FSL3N3S
L2	2.7 nH	IND, 0603, +/-0.3nH	TOKO	LL1608-FSL2N7S
L3	33 nH	IND, 0805, 5%, Wirewound	Coilcraft	0805CS-330XJL

### Typical Performance, TQP7M9103-PCB900

Test conditions unless otherwise noted:  $V_{CC} = +5\text{ V}$ ,  $I_{CQ} = 235\text{ mA}$ ,  $\text{Temp.} = +25\text{ }^\circ\text{C}$

Parameter	Conditions	Typical Value			Units
Frequency		920	940	960	MHz
Gain		20.6	20.6	20.5	dB
Input Return Loss		12	12	11.8	dB
Output Return Loss		18	18.5	19.5	dB
Output P1dB		+29.8	+29.9	30	dBm
OIP3	$P_{out} = +19\text{ dBm / tone}$ , $\Delta f = 1\text{ MHz}$	+46.5	+44.8	+44	dBm
WCDMA Channel Power <sup>(1)</sup>	ACLR = -50 dBc	+20.2	+20.2	+20.2	dBm

Notes:

- 3GPP WCDMA, TM1+64 DPCH, +5 MHz offset, PAR = 10.2 dB at 0.01% Prob.

### Performance Plots, TQP7M9103-PCB900

Test conditions unless otherwise noted:  $V_{CC} = +5\text{ V}$ ,  $I_{CQ} = 235\text{ mA}$ ,  $\text{Temp.} = +25\text{ }^\circ\text{C}$

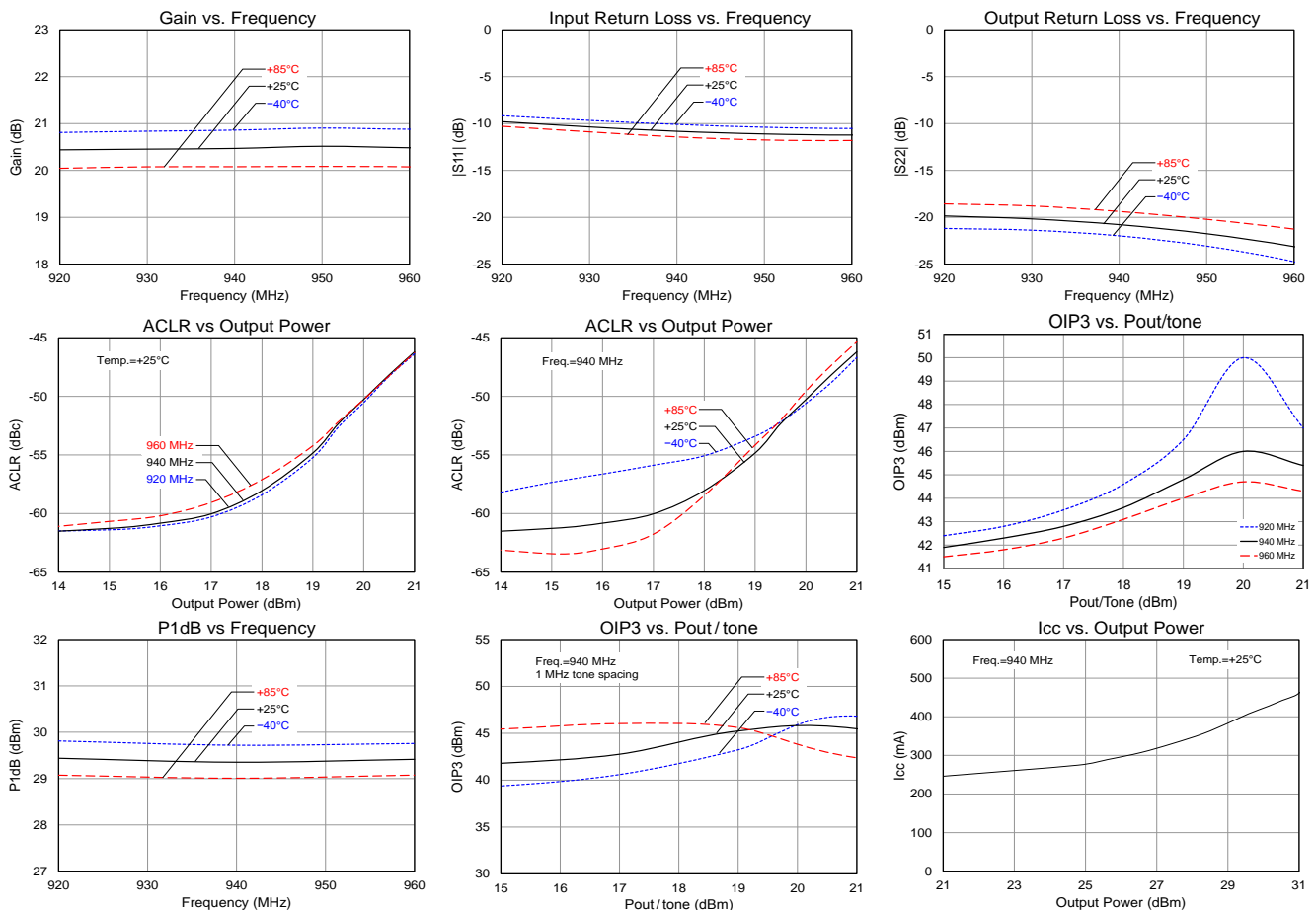

**Evaluation Board, 1805-1880 MHz Reference Design**

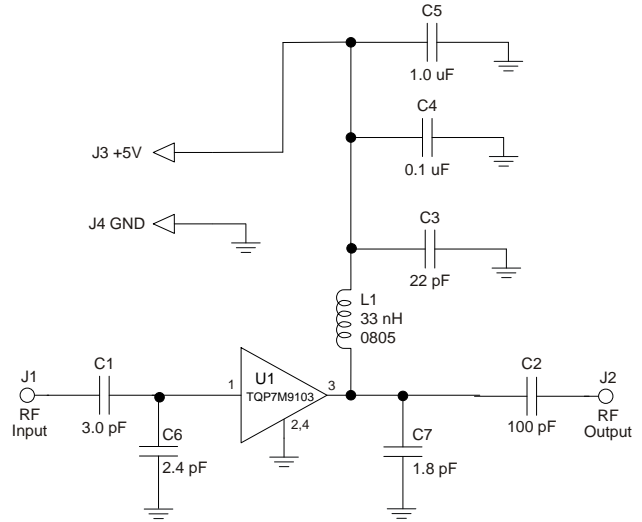
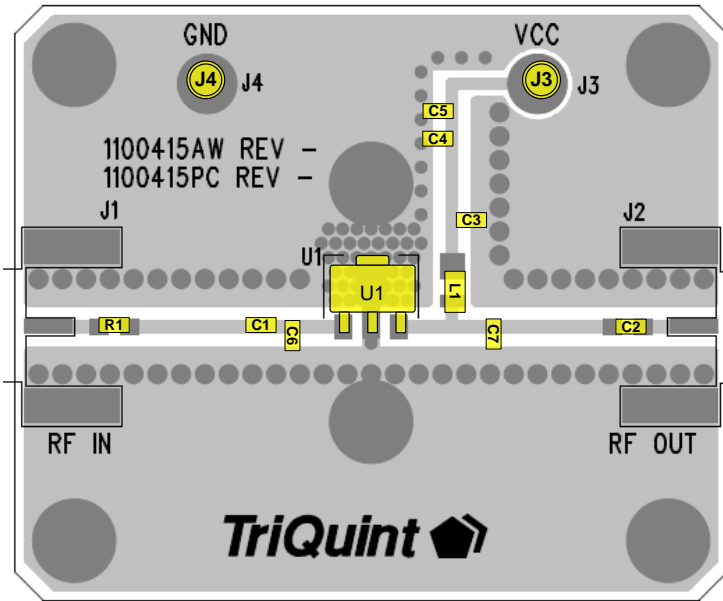

**Notes:**

1. All components are of 0603 size unless stated on the schematic.
2. Distance from right edge of C6 to left edge of device pin 1 pad is 65mil
3. Distance from right edge of C1 to left edge of device pin 1 pad is 110mil
4. Distance from left edge of C7 to right edge of device pin 3 pad is 210mil

**Bill of Material, 1805 – 1880 MHz**

Reference Des.	Value	Description	Manuf.	Part Number
n/a	n/a	Printed Circuit Board	Qorvo	
U1	n/a	TQP7M9103 Amplifier, SOT-89 pkg.	Qorvo	
C1	3.0 pF	Cap., Chip, 0603, +/-0.1pF, 200V	AVX	06032U3R0BAT2A
C6	2.4 pF	Cap., Chip, 0603, +/-0.1pF, 200V	AVX	06032U2R4BAT2A
C7	1.8 pF	Cap., Chip, 0603, +/-0.1pF, 200V	AVX	06032U1R8BAT2A
C2	100 pF	Cap., Chip, 0603	various	
C3	22 pF	Cap., Chip, 0603	various	
C4	0.1 uF	Cap., Chip, 0603, 10%, 16V, X7R	various	
C5	1 uF	Cap., Chip, 0603, 10%, 10V, X5R	various	
L1	33 nH	Inductor, 0805, 5%, Coilcraft HP Series	Coilcraft	
R1	0 Ω	Res, chip, 0603	various	

## Typical Performance, 1805 – 1880 MHz

Test conditions unless otherwise noted:  $V_{CC} = +5\text{ V}$ ,  $I_{CQ} = 235\text{ mA}$ ,  $Temp. = +25\text{ }^{\circ}\text{C}$

Parameter	Conditions	Typical Value			Units
Frequency		1805	1850	1880	MHz
Gain		17.7	17.7	17.7	dB
Input Return Loss		11.6	12.3	12.1	dB
Output Return Loss		16.1	16.3	16.6	dB
Output P1dB		+29.5	+29.6	+29.5	dBm
OIP3	Pout = +16 dBm / tone, $\Delta f = 1\text{ MHz}$	+44.1	+43.8	+43.2	dBm
WCDMA Channel Power <sup>(1)</sup>	ACLR = -50 dBc	+20.0	+20.2	+20.2	dBm

Notes:

- 3GPP WCDMA, TM1+64 DPCH, +5 MHz offset, PAR = 10.2 dB at 0.01% Prob.

## RF Performance Plots, 1805 – 1880 MHz

Test conditions unless otherwise noted:  $V_{CC} = +5\text{ V}$ ,  $I_{CQ} = 235\text{ mA}$ ,  $Temp. = +25\text{ }^{\circ}\text{C}$

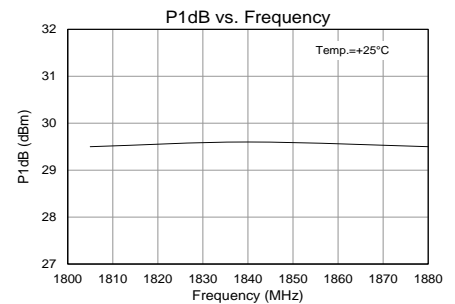
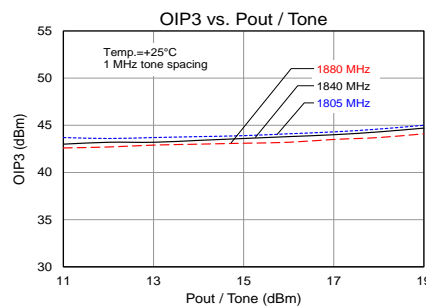
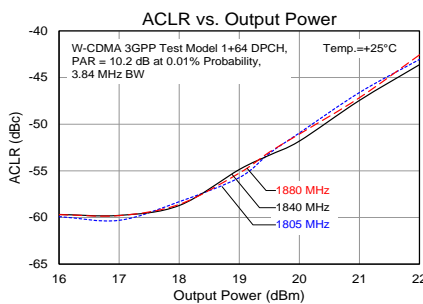
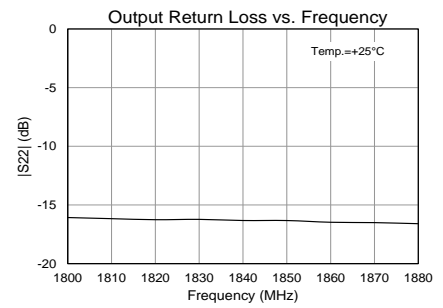
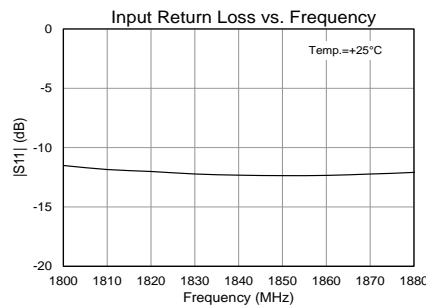
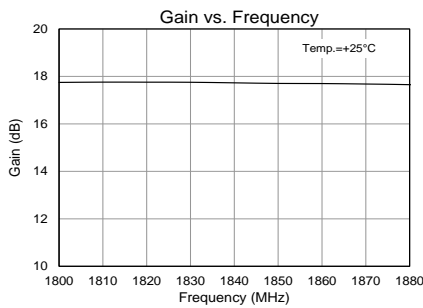

## Typical Performance, 1930 – 1990 MHz

Test conditions unless otherwise noted:  $V_{CC} = +5\text{ V}$ ,  $I_{CQ} = 235\text{ mA}$ ,  $Temp. = +25\text{ }^\circ\text{C}$

Parameter	Conditions	Typical Value			Units
Frequency		1930	1960	1990	MHz
Gain		17.0	17.0	16.9	dB
Input Return Loss		15.2	17.8	18.3	dB
Output Return Loss		13.0	12.9	12.8	dB
Output P1dB		+29.3	+29.3	+29.3	dBm
OIP3	$P_{out} = +16\text{ dBm} / \text{tone}, \Delta f = 1\text{ MHz}$	+44.0	+45.2	+44.2	dBm
WCDMA Channel Power <sup>(1)</sup>	ACLR = -50 dBc	+20.0	+20.0	+20.0	dBm

Notes:

- 3GPP WCDMA, TM1+64 DPCH, +5 MHz offset, PAR = 10.2 dB at 0.01% Prob.

## RF Performance Plots, 1930 – 1990 MHz

Test conditions unless otherwise noted:  $V_{CC} = +5\text{ V}$ ,  $I_{CQ} = 235\text{ mA}$ ,  $Temp. = +25\text{ }^\circ\text{C}$

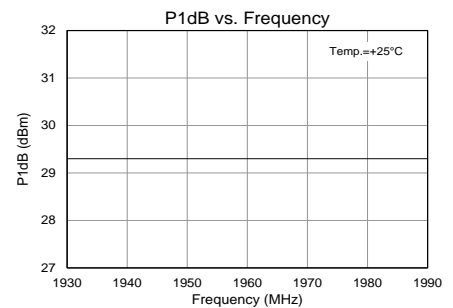
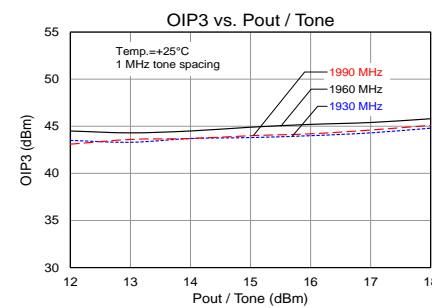
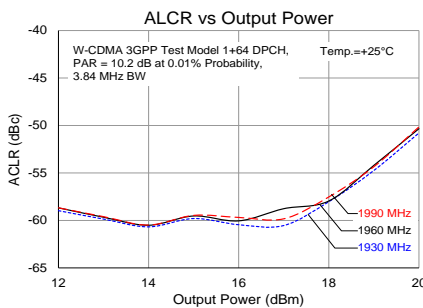
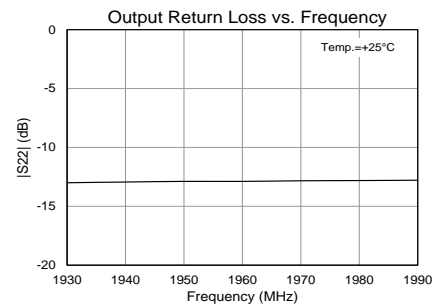
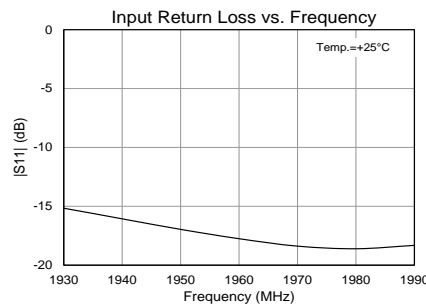
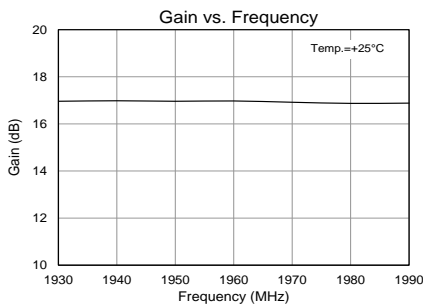

**TQP7M9103-PCB2140 Evaluation Board**

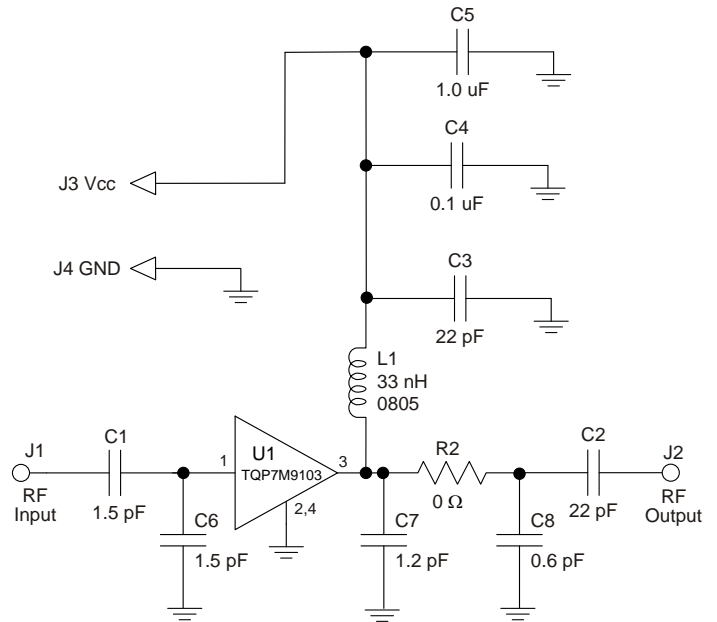
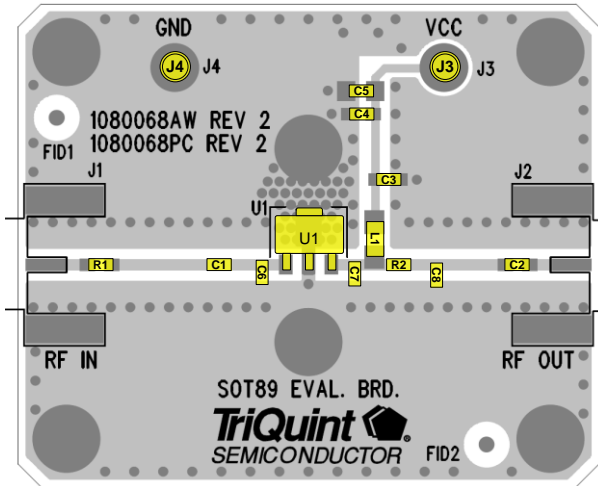

**Notes:**

1. See PC Board Layout, page 11 for more information.
2. Components shown on the silkscreen but not on the schematic are not used.
3. Component (R1) is a 0 Ω resistors may be replaced with copper trace in the target application layout.
4. The recommended component values are dependent upon the frequency of operation.
5. All components are of 0603 size unless stated on the schematic.
6. Critical component placement locations:  
 Distance from U1 Pin 1 Pad (left edge) to C6 (right edge): 28 Mils (3.0° at 2140 MHz)  
 Distance from C6 (left edge) to C1 (right edge): 65 Mils (7.0° at 2140 MHz)  
 Distance from U1 Pin 3 Pad (right edge) to C7 (left edge): 31 Mils (3.4° at 2140 MHz)  
 Distance from C7 (right edge) to R2 (left edge): 60 Mils (6.5° at 2140 MHz)  
 Distance from R2 (right edge) to C8 (left edge): 62 Mils (6.7° at 2140 MHz)

**Bill of Material, TQP7M9103-PCB2140**

Reference Des.	Value	Description	Manuf.	Part Number
n/a	n/a	Printed Circuit Board	Qorvo	1080068
U1	n/a	TQP7M9103 Amplifier, SOT-89 pkg.	Qorvo	TQP7M9103
C1, C6	1.5 pF	Cap., Chip, 0603, +/-0.05pF, 50V, Accu-P	AVX	06032U1R5BAT2A
C2, C3	22 pF	Cap., Chip, 0603, 5%, 50V, NPO/COG	various	
C4	0.1 uF	Cap., Chip, 0603, 10%, 16V, X7R	various	
C5	1.0 uF	Cap., Chip, 0603, 10%, 10V, X5R	various	
C7	1.2 pF	Cap., Chip, 0603, +/-0.05pF, 50V, Accu-P	AVX	06035J1R2ABSTR
C8	0.6 pF	Cap., Chip, 0603, +/-0.05pF, 50V, Accu-P	AVX	06035J0R6ABSTR
R1, R2	0 Ω	Resistor, Chip, 0603, 5%, 1/16W	various	
L1	33 nH	Inductor, 0805, 5%, Coilcraft CS Series	Coilcraft	0805CS-330XJLB

## Typical Performance, TQP7M9103-PCB2140

Test conditions unless otherwise noted:  $V_{CC} = +5\text{ V}$ ,  $I_{CQ} = 235\text{ mA}$ , Temp. =  $+25\text{ }^\circ\text{C}$

Parameter	Conditions	Typical Value			Units
Frequency		2110	2140	2170	MHz
Gain		16.7	16.6	16.6	dB
Input Return Loss		11.7	12.0	11.7	dB
Output Return Loss		16.5	16.0	15.2	dB
Output P1dB		+29.5	+29.5	+29.6	dBm
OIP3	Pout = +11 dBm / tone, $\Delta f = 1\text{ MHz}$	+45.0	+45.0	+45.0	dBm
WCDMA Channel Power <sup>(1)</sup>	ACLR = -50 dBc	+20	+20	+20	dBm
Noise figure		4.4	4.4	4.6	dB

Notes:

- 3GPP WCDMA, TM1+64 DPCH, +5 MHz offset, PAR = 10.2 dB at 0.01% Prob.

## Performance Plots, TQP7M9103-PCB2140

Test conditions unless otherwise noted:  $V_{CC} = +5\text{ V}$ ,  $I_{CQ} = 235\text{ mA}$ , Temp. =  $+25\text{ }^\circ\text{C}$

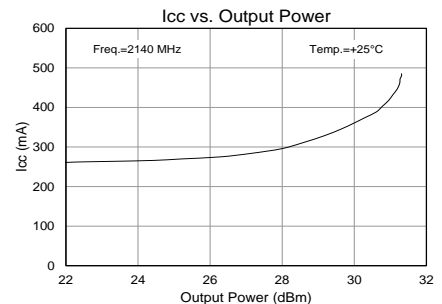
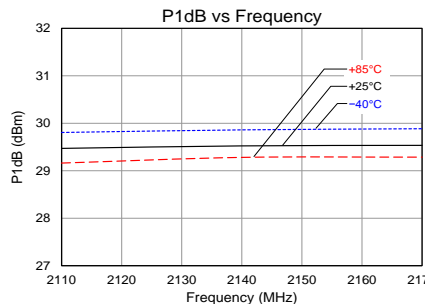
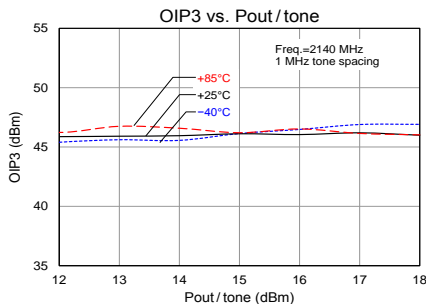
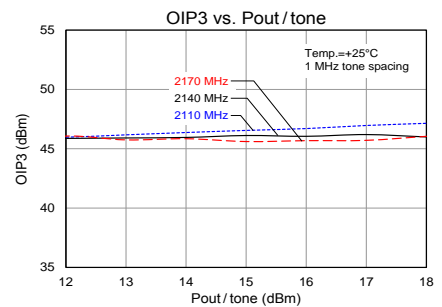
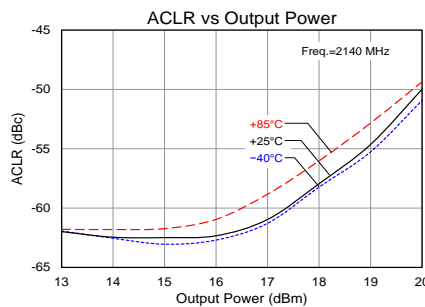
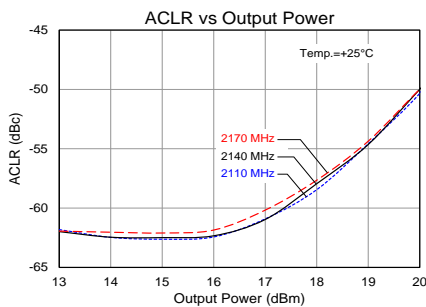
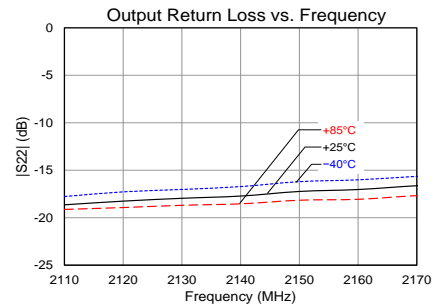
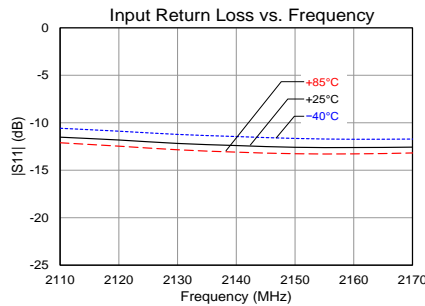
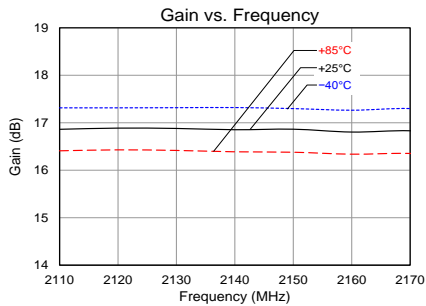

**Evaluation Board, 2300 – 2400 MHz Reference Design**

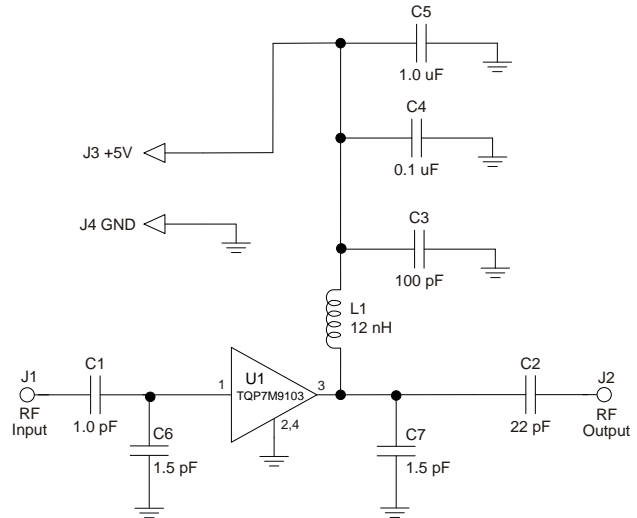
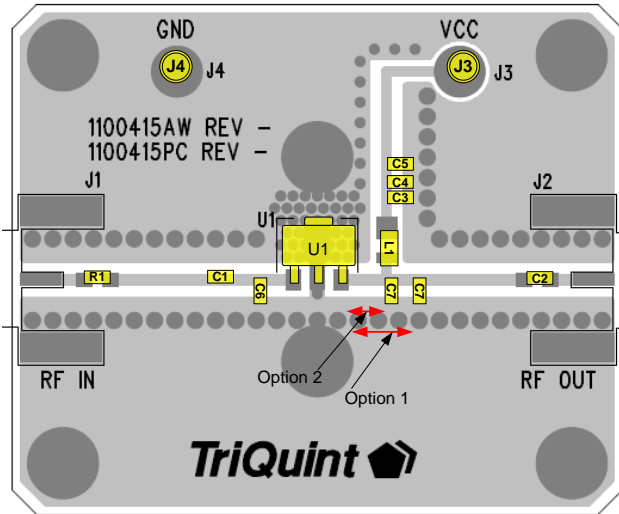

**Notes:**

- 14. Components shown on the silkscreen but not on the schematic are not used.
- 15. 0 Ω resistor can be replaced with copper trace in the target application layout.
- 16. All components are of 0603 size unless stated on the schematic.
- 17. The recommended component values are dependent upon the frequency of operation.
- 18. Critical component placement locations:
  - Distance between U1 Pin 1(left edge) to C1 (right edge): 135 mil
  - Distance between U1 Pin 1(left edge) to C6 (right edge): 30 mil
  - Distance between U1 Pin 3(right edge) to C7 (left edge): 145 mil for Option 1 and 85 mil for Option 2

**Bill of Material, 2300 – 2400 MHz**

Reference Des.	Value	Description	Manuf.	Part Number
n/a	n/a	Printed Circuit Board	Qorvo	
U1	n/a	1 W High Linearity Amplifier	Qorvo	TQP7M9103
C1	1 pF	CAP, 0603, +/-0.1pF, 100V, NPO/COG	Murata	GQM1885C2A1R0BB01J
C6, C7	1.5 pF	CAP, 0603, +/-0.1pF, 100V, NPO/COG	Murata	GQM1885C2A1R5BB01J
C3	100 pF	CAP, 0603	various	
C2	22 pF	CAP, 0603	various	
C4	0.1 uF	CAP, chip, 0603	Various	
C5	1.0 uF	CAP, 0603, 10%, X5R , 10V	Various	
R1	0 Ω	RES, chip, 0603	Various	
L1	12 nH	IND, 0805, 5%, Wirewound	Coilcraft	0805CS-120XJL



### Typical Performance (Option 1)

Test Conditions:  $V_{CC}=+5\text{ V}$ ,  $\text{Temp.}=+25^{\circ}\text{C}$ ,  $50\Omega$  System

Parameter	Conditions	Typical Value			Units
Frequency		2300	2350	2400	MHz
Gain		16.6	16.6	16.5	dB
Input Return Loss		13.3	16	15	dB
Output Return Loss		16.2	16.4	16.4	dB
Output P1dB		+29.3	+29.4	+29.4	dBm
Output IP3	Pout= +18 dBm/tone, $\Delta f= 1\text{ MHz}$	+44	+43.9	+43.6	dBm
Quiescent Collector Current, $I_{CQ}$		225			mA

### Typical Performance (Option 2)

Test Conditions:  $V_{CC}=+5\text{ V}$ ,  $\text{Temp.}=+25^{\circ}\text{C}$ ,  $50\Omega$  System

Parameter	Conditions	Typical Value			Units
Frequency		2300	2350	2400	MHz
Gain		16.2	16.2	16.2	dB
Input Return Loss		14.5	19	20	dB
Output Return Loss		9.7	9.6	9.8	dB
Output P1dB		+30	+30.1	+30.3	dBm
Output IP3	Pout= +18 dBm/tone, $\Delta f= 1\text{ MHz}$	+41.6	+41.5	+41.1	dBm
Quiescent Collector Current, $I_{CQ}$		225			mA

### Performance Plots, 2300 – 2400 MHz

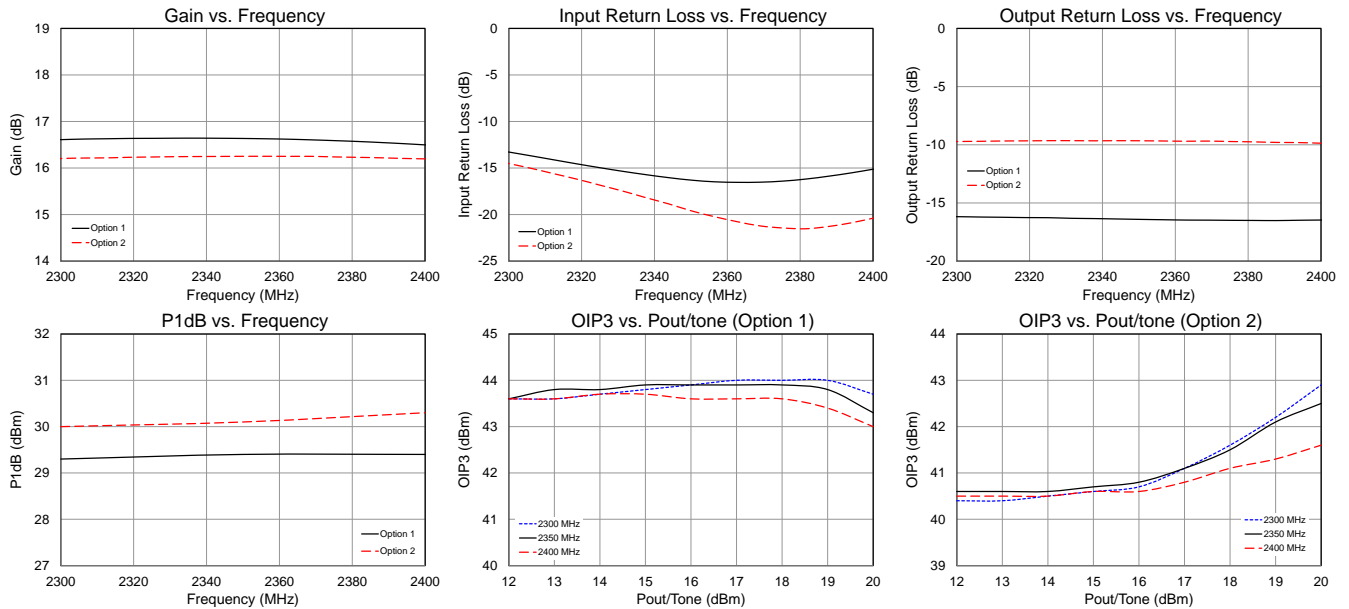

## Evaluation Board, 2500 – 2700 MHz Reference Design

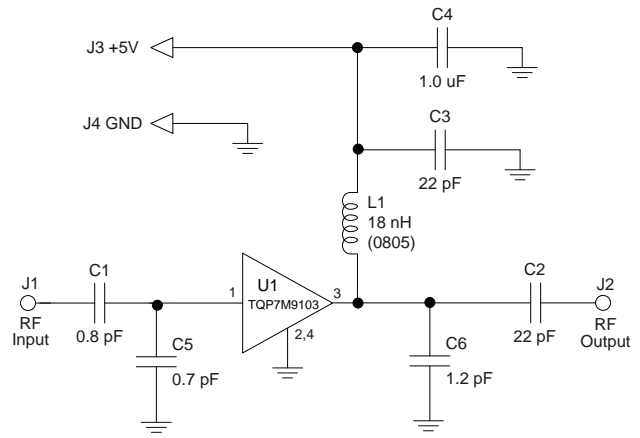
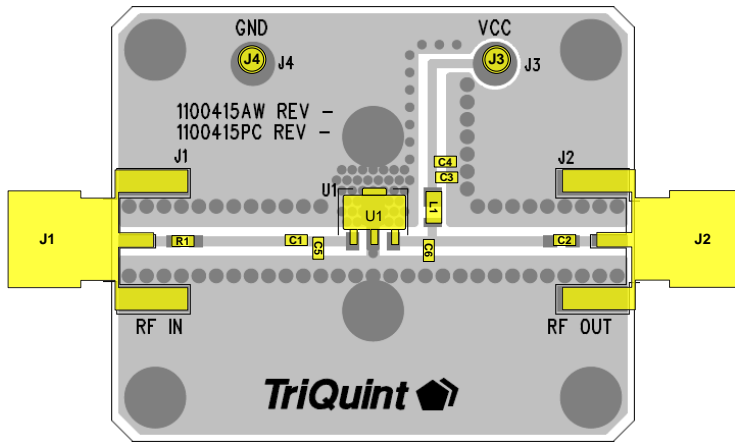

**Notes:**

- 19. Components shown on the silkscreen but not on the schematic are not used.
- 20. 0 Ω resistor can be replaced with copper trace in the target application layout.
- 21. All components are of 0603 size unless stated on the schematic.
- 22. The recommended component values are dependent upon the frequency of operation.
- 23. Critical component placement locations:
  - Distance between U1 Pin 1 Pad to C5 (right edge): 80 mil
  - Distance between U1 Pin 1 Pad to C1 (right edge): 120 mil
  - Distance between U1 Pin 3 Pad to C6 (left edge): 55 mil

## Bill of Material, 2500 – 2700 MHz

Reference Des.	Value	Description	Manuf.	Part Number
n/a	n/a	Printed Circuit Board	Qorvo	1100415
U1	n/a	1 W High Linearity Amplifier	Qorvo	TQP7M9103
C1	0.8 pF	CAP, 0603, ± 0.1 pF, 100V, NPO/COG	AVX	06032U0R8BAT2A
C5	0.7 pF	CAP, 0603, ± 0.05 pF, 50V, ACCU-P	AVX	06035J0R7ABSTR
C2, C3	22 pF	CAP, 0603, 5%, 50V, NPO/COG	various	
C4	1.0 uF	CAP, 0603, 10%, X5R , 10V	various	
C6	1.2 pF	CAP, 0603, ± 0.1 pF, 100V, NPO/COG	AVX	06035J1R2ABSTR
R1	0 Ω	RES, 0603, 5%, 1/16W, Chip	various	
L1	18 nH	IND, 0805, 5%, Ceramic	Coilcraft	0805CS-180XJL

## Typical Performance, 2500 – 2700 MHz

Test conditions unless otherwise noted:  $V_{CC} = +5\text{ V}$ ,  $I_{CQ} = 235\text{ mA}$ ,  $\text{Temp.} = +25\text{ }^\circ\text{C}$

Parameter	Conditions	Typical Value			Units
Frequency		2500	2600	2700	MHz
Gain		14.9	15.2	15.0	dB
Input Return Loss		-6.5	-9.0	-10.5	dB
Output Return Loss		-20.0	-18.7	-17.1	dB
Output P1dB		+29.7	+29.6	+29.8	dBm
OIP3	$P_{out} = +11\text{ dBm / tone, } \Delta f = 1\text{ MHz}$	+43.7	+43.7	+44.1	dBm
WCDMA Channel Power <sup>(1)</sup>	ACLR = -50 dBc	+20	+20	+20	dBm

Notes:

- 3GPP WCDMA, TM1+64 DPCH, +5 MHz offset, PAR = 10.2 dB at 0.01% Prob.

## Performance Plots, 2500 – 2700 MHz

Test conditions unless otherwise noted:  $V_{CC} = +5\text{ V}$ ,  $I_{CQ} = 235\text{ mA}$ ,  $\text{Temp.} = +25\text{ }^\circ\text{C}$

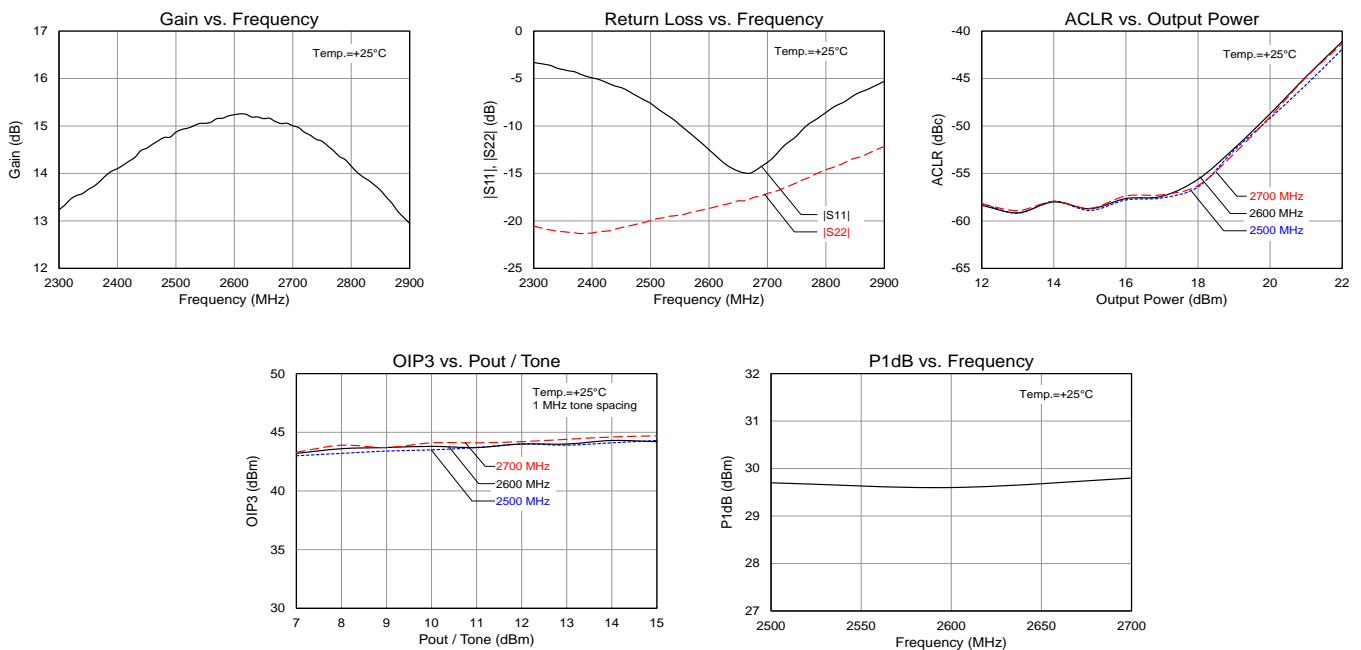

**Evaluation Board, 3400 – 3600 MHz Reference Design**

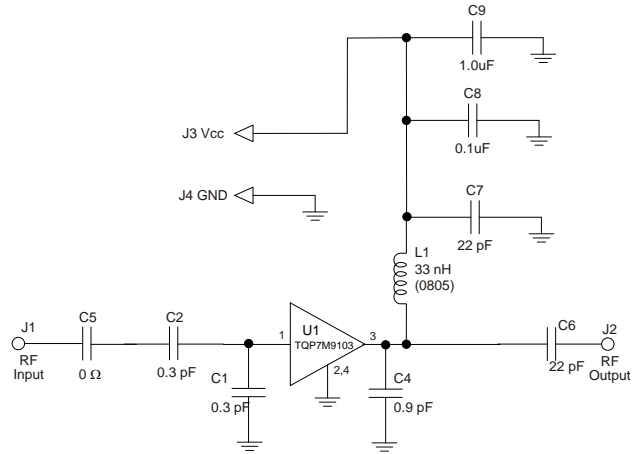
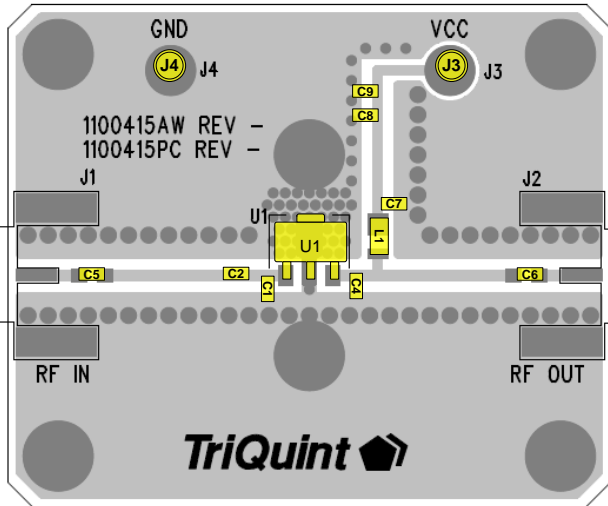

**Notes:**

1. All components are of 0603 size unless stated on the schematic.
2. Distance from right edge of C1 to device pin is 43mil
3. Distance from right edge of C2 to device pin is 75mil
4. Distance from right edge of C4 to device pin is 15mil

**Bill of Material, 3400 – 3600 MHz**

Reference Des.	Value	Description	Manuf.	Part Number
n/a	n/a	Printed Circuit Board	Qorvo	
U1	n/a	TQP7M9103 Amplifier, SOT-89 pkg.	Qorvo	
C1, C2	0.3 pF	Cap., Chip, 0603, +/-10.05pF, 50V	AVX	06035J0R3ABSTR
C4	0.9 pF	Cap., Chip, 0603, 5%, 50V, NPO/COG	AVX	06035J0R9ABSTR
C6, C7	22 pF	Cap., Chip, 0603, 5%, 50V, NPO/COG	various	
C8	0.1 uF	Cap., Chip, 0603, 10%, 16V, X7R	various	
C9	1 uF	Cap., Chip, 0603, 10%, 10V, X5R	various	
L1	33 nH	Inductor, 0603, 5%, Coilcraft CS Series	Coilcraft	0603CS-33NXJL
C5	0 Ω	Res, chip, 0603	various	

## Typical Performance, 3400 – 3600 MHz

Test conditions unless otherwise noted:  $V_{CC} = +5\text{ V}$ ,  $I_{CQ} = 235\text{ mA}$ ,  $Temp. = +25\text{ }^{\circ}\text{C}$

Parameter	Conditions	Typical Value			Units
Frequency		3400	3500	3600	MHz
Gain		13.1	13.5	13	dB
Input Return Loss		8.2	17	11	dB
Output Return Loss		18.5	16	13.7	dB
Output P1dB		+29.2	+29.2	+28.9	dBm
Output IP3	$P_{out} = +10\text{ dBm / tone, } \Delta f = 1\text{ MHz}$	+41	+40.4	+39.7	dBm

## Performance Plots, 3400 – 3600 MHz

Test conditions unless otherwise noted:  $V_{CC} = +5\text{ V}$ ,  $I_{CQ} = 235\text{ mA}$ ,  $Temp. = +25\text{ }^{\circ}\text{C}$

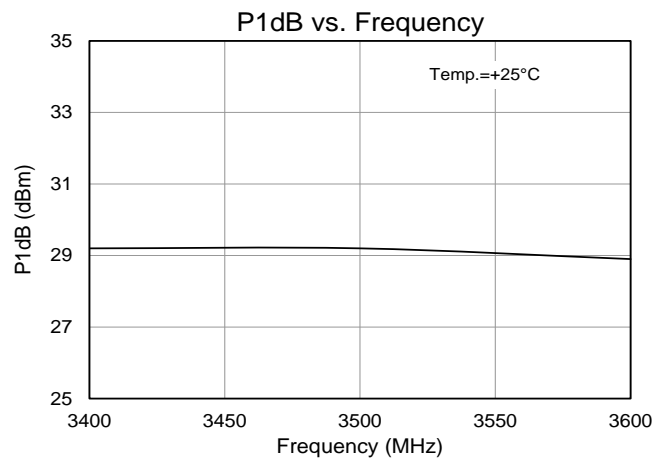
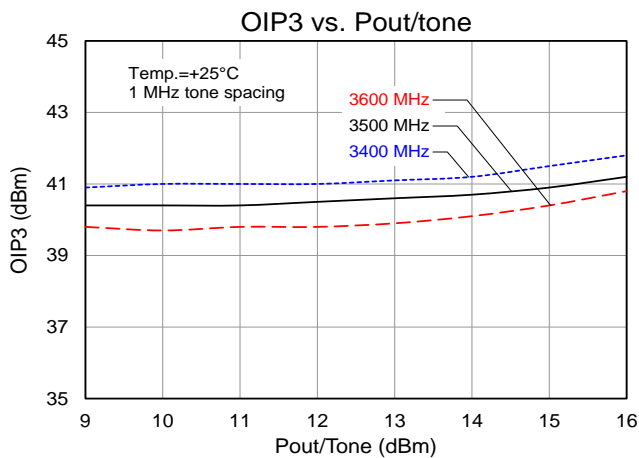
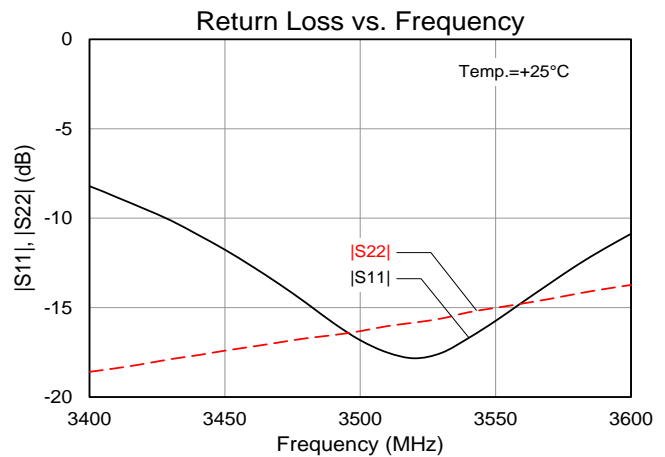
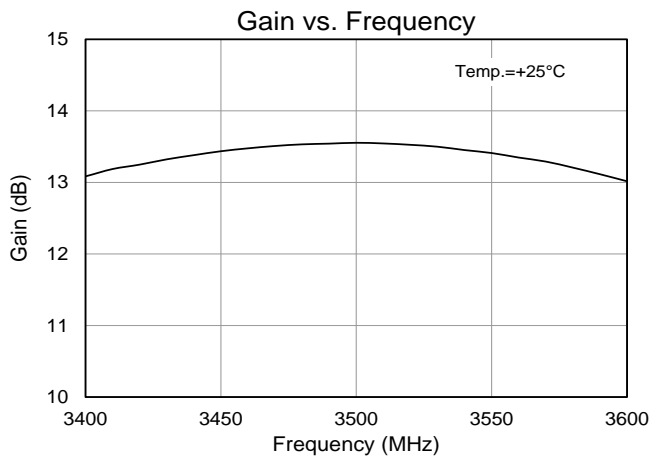

**Pin Configuration and Description**

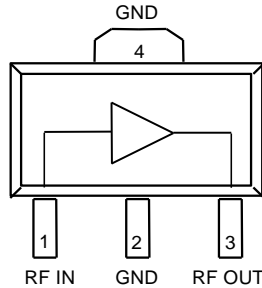

Pin No.	Label	Description
1	RF IN	RF Input. Requires external match for optimal performance. External DC Block required.
2, 4	GND	RF/DC Ground Connection
3	RF OUT / Vcc	RF Output. Requires external match for optimal performance. External DC Block and supply voltage is required.

**Evaluation Board PCB Information**

Qorvo PCB 1080068 Material and Stack-up

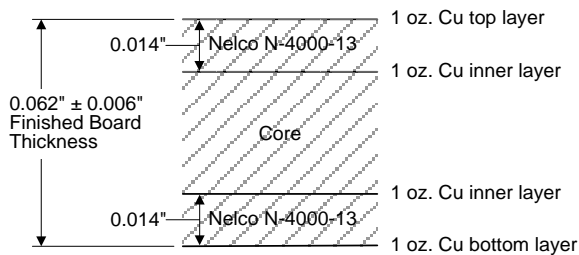

50 ohm line dimensions: width = .028", spacing = .028".

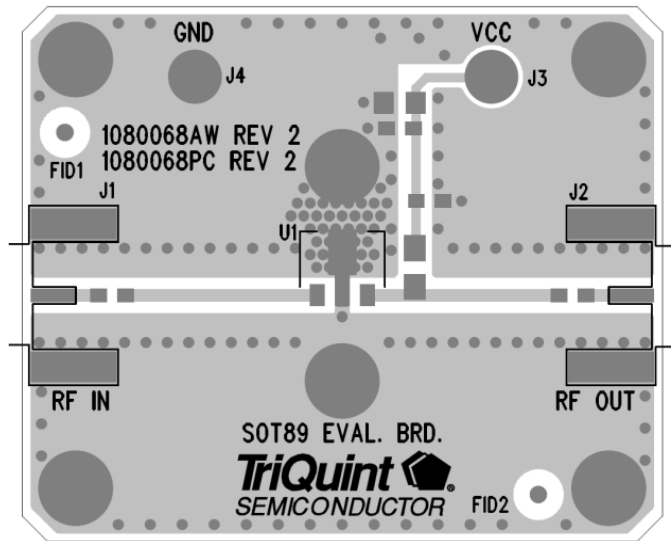

## Package Marking and Dimensions

Marking: Part Identifier – 7M9103  
Lot code – YXXX

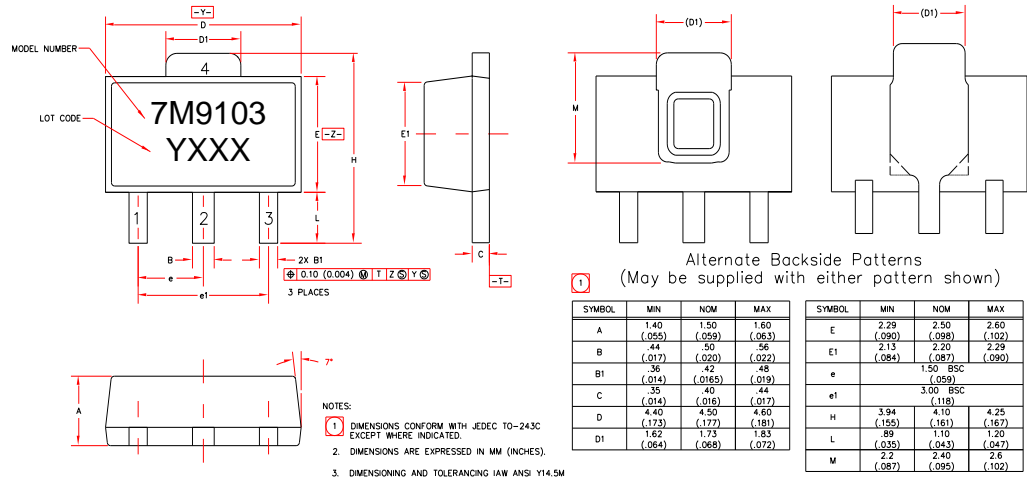

### Notes:

1. All dimensions are in millimeters. Angles are in degrees.
2. Dimension and tolerance formats conform to ASME Y14.4M-1994.
3. The terminal #1 identifier and terminal numbering conform to JESD 95-1 SPP-012.
4. Contact plating: NiPdAu

## PCB Mounting Pattern

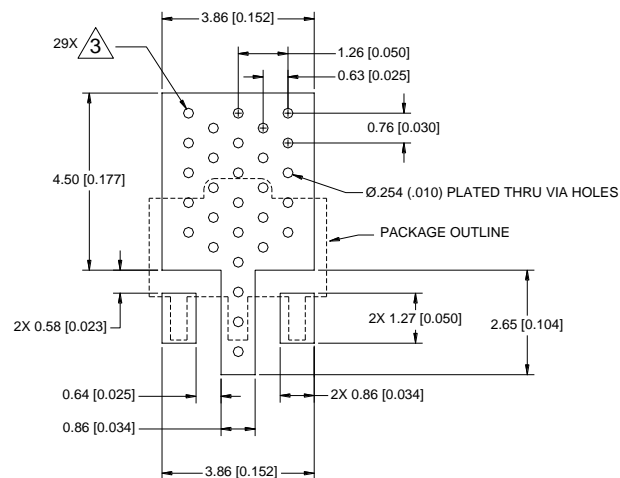

### NOTES:

1. All dimensions are in millimeters [inches]. Angles are in degrees.
2. Use 1 oz. copper minimum for top and bottom layer metal.
3. Vias are required under the backside paddle of this device for proper RF/DC grounding and thermal dissipation. We recommend a 0.35mm (#80/.0135") diameter bit for drilling via holes and a final plated thru diameter of 0.25mm (0.10").
4. Ensure good package backside paddle solder attach for reliable operation and best electrical performance.

## Handling Precautions

Parameter	Rating	Standard
ESD – Human Body Model (HBM)	2	ESDA / JEDEC JS-001-2012
ESD – Charged Device Model (CDM)	C3	JEDEC JESD22-C101F
MSL – Moisture Sensitivity Level	Level 3	IPC/JEDEC J-STD-020



Caution!  
ESD-Sensitive Device

## Solderability

Compatible with both lead-free (260°C max. reflow temp.) and tin/lead (245°C max. reflow temp.) soldering processes. Solder profiles available upon request.

Contact plating: NiPdAu

## RoHS Compliance

This part is compliant with the 2011/65/EU RoHS directive (Restrictions on the Use of Certain Hazardous Substances in Electrical and Electronic Equipment) as amended by Directive 2015/863/EU. This product also has the following attributes:

- Product uses RoHS Exemption 7c-I to meet RoHS Compliance requirements.
- Halogen Free (Chlorine, Bromine)
- Antimony Free
- TBBP-A (C<sub>15</sub>H<sub>12</sub>Br<sub>4</sub>O<sub>2</sub>) Free
- PFOS Free
- SVHC Free

## Contact Information

For the latest specifications, additional product information, worldwide sales and distribution locations:

**Web:** [www.qorvo.com](http://www.qorvo.com)

**Tel:** 1-844-890-8163

**Email:** [customer.support@qorvo.com](mailto:customer.support@qorvo.com)

For technical questions and application information:

**Email:** [appsupport@qorvo.com](mailto:appsupport@qorvo.com)

## Important Notice

The information contained herein is believed to be reliable; however, Qorvo makes no warranties regarding the information contained herein and assumes no responsibility or liability whatsoever for the use of the information contained herein. All information contained herein is subject to change without notice. Customers should obtain and verify the latest relevant information before placing orders for Qorvo products. The information contained herein or any use of such information does not grant, explicitly or implicitly, to any party any patent rights, licenses, or any other intellectual property rights, whether with regard to such information itself or anything described by such information. **THIS INFORMATION DOES NOT CONSTITUTE A WARRANTY WITH RESPECT TO THE PRODUCTS DESCRIBED HEREIN, AND QORVO HEREBY DISCLAIMS ANY AND ALL WARRANTIES WITH RESPECT TO SUCH PRODUCTS WHETHER EXPRESS OR IMPLIED BY LAW, COURSE OF DEALING, COURSE OF PERFORMANCE, USAGE OF TRADE OR OTHERWISE, INCLUDING THE IMPLIED WARRANTIES OF MERCHANTABILITY AND FITNESS FOR A PARTICULAR PURPOSE.**

Without limiting the generality of the foregoing, Qorvo products are not warranted or authorized for use as critical components in medical, life-saving, or life-sustaining applications, or other applications where a failure would reasonably be expected to cause severe personal injury or death.

Copyright 2018 © Qorvo, Inc. | Qorvo is a registered trademark of Qorvo, Inc.



## Данный компонент на территории Российской Федерации

### Вы можете приобрести в компании MosChip.

Для оперативного оформления запроса Вам необходимо перейти по данной ссылке:

<http://moschip.ru/get-element>

Вы можете разместить у нас заказ для любого Вашего проекта, будь то серийное производство или разработка единичного прибора.

В нашем ассортименте представлены ведущие мировые производители активных и пассивных электронных компонентов.

Нашей специализацией является поставка электронной компонентной базы двойного назначения, продукции таких производителей как XILINX, Intel (ex.ALTERA), Vicor, Microchip, Texas Instruments, Analog Devices, Mini-Circuits, Amphenol, Glenair.

Сотрудничество с глобальными дистрибьюторами электронных компонентов, предоставляет возможность заказывать и получать с международных складов практически любой перечень компонентов в оптимальные для Вас сроки.

На всех этапах разработки и производства наши партнеры могут получить квалифицированную поддержку опытных инженеров.

Система менеджмента качества компании отвечает требованиям в соответствии с ГОСТ Р ИСО 9001, ГОСТ РВ 0015-002 и ЭС РД 009

### Офис по работе с юридическими лицами:

105318, г.Москва, ул.Щербаковская д.3, офис 1107, 1118, ДЦ «Щербаковский»

Телефон: +7 495 668-12-70 (многоканальный)

Факс: +7 495 668-12-70 (доб.304)

E-mail: [info@moschip.ru](mailto:info@moschip.ru)

Skype отдела продаж:

moschip.ru

moschip.ru\_4

moschip.ru\_6

moschip.ru\_9