

MISCELLANEOUS HARDWARE & ACCESSORIES

SPECIFICATIONS SUBJECT TO CHANGE WITHOUT NOTICE

| | |
|--|------------------|
| SWITCH HARDWARE..... | D2 - D4 |
| PUSHBUTTON AND TOGGLE CAPS..... | D5 - D6 |
| SECURITY GUARDS..... | D7 - D9 |
| SEALING BOOTS..... | D10 - D14 |
| VL SERIES LED INDICATORS..... | D15 - D16 |



MISCELLANEOUS HARDWARE

HEX NUT A112 Nickel plated brass
1/4-40



HEX NUT Brass 1/4-40
Nickel plated **U76** Matte black **U94**



HEX NUT Brass
Nickel plated **U208** Matte black **U726**



HEX NUT Brass
Chrome plated **U1916**



HEX NUT U842 10mm (.393")
Nickel plated brass

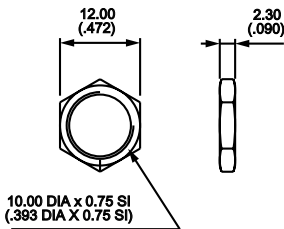

HEX NUT A465
Nickel plated brass 15/32-32



HEX NUT Brass 15/32-32
Nickel plated **U162** Matte black **U41**
Chrome plated **U92**



HEX NUT Brass 12mm (.472")
Nickel plated **U166** Matte black **U183**
Chrome plated **U212**



HEX CAP NUT Brass 12mm (.472")
Chrome plated **U35**

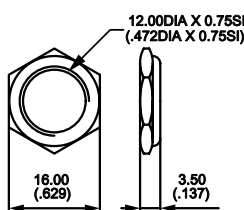

PAL NUT U42 12mm (.472")
Zinc plated steel

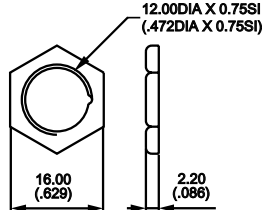

HEX NUT 10-621 16mm (.629")
Nickel plated brass



HEX NUT U1950-5 19mm (.748")
Nickel plated brass



HEX NUT 10-855-5 19mm (.748")
Nickel plated brass

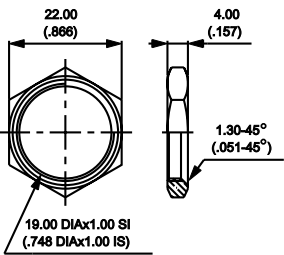

HEX NUT U1951-5 22mm (.866")
Nickel plated brass



HEX NUT 10-856-5 22mm (.866")
Nickel plated brass



HEX NUT U2059-5 24mm (.944")
Nickel plated brass



PANEL DRESS NUT A168P1
Blind thread, Nickel plated brass
1/4-40



PANEL DRESS NUT A168P2
Thru thread, Nickel plated brass
1/4-40



PANEL DRESS NUT A274
Nickel plated brass 1/4-40

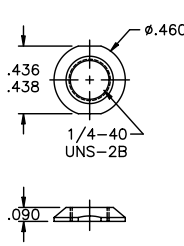

PANEL DRESS NUT A540
Nickel plated brass 15/32-32



SPECIFICATIONS SUBJECT TO CHANGE WITHOUT NOTICE

D

MISCELLANEOUS HARDWARE (CONT'D.)

SPECIFICATIONS SUBJECT TO CHANGE WITHOUT NOTICE

D

| | | | |
|--|--|---|--|
| <p>DECORATIVE NUT A447 Thru thread, chromium plated brass 1/4-40</p>  | <p>KNURLED NUT U369 1/4-40 Nickel plated brass</p>  | <p>KNURLED NUT U501 1/4-40 Chrome plated brass</p>  | <p>KNURLED NUT Brass 1/4-40 Nickel plated U229 Matte black U230</p>  |
| <p>KNURLED NUT U826 Nickel plated brass</p>  | <p>KNURLED CAP NUT Brass 1/4-40 Chrome plated U216 Matte black U218</p>  | <p>KNURLED CAP NUT Brass Chrome pl. U461 Matte black U502</p>  | <p>KNURLED CAP NUT Brass Chrome plated U232</p>  |
| <p>KNURLED CAP NUT Brass 1/4-40 Chrome pl. U268 Matte black U725</p>  | <p>KNURLED NUT U2311 10mm (.393") Chrome plated brass</p>  | <p>KNURLED CAP NUT U2220 10mm (.393") Chrome plated brass</p>  | <p>KNURLED NUT Brass 15/32-32 Nickel plated U53 Matte black U1634</p>  |
| <p>KNURLED CAP NUT U123 15/32-32 Chrome plated brass</p>  | <p>KNURLED CAP NUT U124 15/32-32 Chrome plated brass</p>  | <p>PANEL DRESS NUT Brass 12mm (.472") Nickel plated U411, Matte black U413, Chrome plated U412</p>  | <p>KNURLED CAP NUT Brass 12mm (.472") Chrome plated U117 Matte black U129</p>  |
| <p>KNURLED CAP NUT Brass 12mm (.472") Chrome plated U118 Matte black U130</p>  | <p>INSULATED PANEL DRESS NUT 12mm (.472") ABS or polyamide with glass fiber. blue U521, black U522, green U523, gray U524, yellow U525, red U526, white U527/1, orange U529</p>  | <p>KNURLED NUT 10-960-5 16mm (.629") Nickel plated brass</p>  | <p>KNURLED NUT U1977-5 19mm (.748") Nickel plated brass</p>  |

MISCELLANEOUS HARDWARE (CONT'D.)

| | | | |
|---|--|--|--|
| <p>LOCKWASHER U14 .122 I.D. Stainless steel</p>  | <p>LOCKWASHER 1/4 Stainless steel U215</p>  | <p>LOCKWASHER A115 Nickel plated steel 1/4</p>  | <p>LOCKWASHER U843 10mm (.393") Stainless steel</p>  |
| <p>LOCKWASHER A466 Nickel plated steel 15/32</p>  | <p>LOCKWASHER U13 15/32 Zinc plated</p>  | <p>ANTI-ROTATE RING A107 Nickel plated brass 1/4</p>  | <p>LOCKING RING 1/4 Nickel plated U78 Matte black U93</p>  |
| <p>LOCKING RING Brass Nickel plated U198 Matte black U728</p>  | <p>ANTI-ROTATE RING (LARGE) A158 Nickel plated brass 1/4</p>  | <p>LOCKING RING U844 10mm (.393") Nickel plated</p>  | <p>ANTI-ROTATE RING A482 Nickel plated brass 15/32</p>  |
| <p>LOCKING RING 12mm (.472") Nickel plated U121 Matte black U12</p>  | <p>SEALING WASHER U360 1/4-40 For keyway bushing</p>  | <p>SEALING WASHER U60 15/32</p>  | <p>SEALING WASHER Nylon 12mm (.472") U21</p>  |
| <p>GROUND CONNECTOR 12mm (.472") Nickel plated U187</p>  | <p>SWITCH PLATE I-O U1050 .480 I.D.</p>  | <p>SWITCH PLATE ON-OFF U19 .480 I.D.</p>  | <p>CONNECTING SCREW U03</p>  |

SPECIFICATIONS SUBJECT TO CHANGE WITHOUT NOTICE

D

MISCELLANEOUS PUSHBUTTON ACCESSORIES & CAPS

Note: additional caps are shown in some switch sections.

PANEL DRESS NUTS & CAPS FOR PUSHBUTTON SWITCHES

| ASSEMBLY NUMBER | FITS SWITCH MODEL | OPTION(S) REQUIRED | INCLUDES | |
|-----------------|-------------------|--------------------|-----------|--------|
| | | | DRESS NUT | CAP |
| A1354P1 | 810/820 | KM | A495P1 | B494P1 |
| A1354P2 | 401/402 | S | A495P1 | B494P2 |
| A1354P3 | PB | PY | A495P1 | B494P3 |
| A1355P1 | 810/820 | KM | A495P2 | B494P1 |
| A1355P2 | 302 | NONE | A495P2 | B494P2 |
| A1355P2 | 401/402 | NONE | A495P2 | B494P2 |
| A1355P3 | PB | PY or P2Y1 | A495P2 | B494P3 |



Order Assembly Number from chart to left. Add cap color no. from color code chart below. Example: A1354P36 indicates assembly to fit a PB switch and is supplied with a red cap.

| SWITCH MODEL | OPTION (IF REQ'D) | A1354 | | A1355 | |
|--------------|-------------------|-------|------|-------|------|
| | | A | P.T. | A | P.T. |
| 810/820 | KM | .040 | .062 | .090 | .093 |
| PB | PY | .100 | .125 | .135 | .171 |
| PB | P2Y1 | - | - | .120 | .093 |
| 302 | - | - | - | .070 | .078 |
| 401/402 | - | - | - | .130 | .078 |
| 401/402 | S | .130 | .062 | - | - |

SPECIFICATIONS SUBJECT TO CHANGE WITHOUT NOTICE



'A' dimension is determined by panel thickness indicated in table and allows for (1) back-up Nut A112 and (1) Lockwasher A115. Order these separately to provide for secure, vibration resistant mounting.

| PART NO. | A DIA. | B DIA. |
|----------|--------|--------|
| A495P1 | .385 | .323 |
| A495P2 | .413 | .245 |

COLOR CAP Vinyl plastisol



| PART NO. | DIM. A | FITS ACTUATOR |
|----------|--------|---------------|
| A118 | 5/16 | K |
| A391 | 3/16 | L2 |
| A392 | 3/4 | L |

PUSHBUTTON CAPS (ALL)

Material - Nylon

Caps press fit adequately, however they may be pulled off. If permanent retention is required, cement with Loctite 405 or equivalent, insuring no cement enters switch.

PUSHBUTTON CAP A212



FITS PB SERIES

COLOR CAPS B366 & B497



B366 fits 300 & 400 Series with S option only, and all PB Series.

B497 fits 800 Series with options KM, KS, KM1, K1M1 & K2M1.

PUSHBUTTON CAPS A180 & A496



A180 fits all PB Series.

A496 fits 800 Series with options KM, KS, KM1, K1M1, K2M, K2S & K2M1.

PUSHBUTTON CAP A235

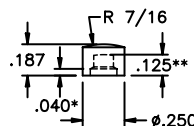

* - fits all PB, 300 & 400 Series.

** - fits 800 Series with options KM, KS, KM1 & K2M1.

PUSHBUTTON CAP A420



* - Fits all 300 Series except 301 & 305. Fits 301 & 305 with S option. Fits all 400 & PB Series.

** - Fits 800 Series with options KM, KS, KM1 & K2M1.

STANDARD COLOR CODE

For nylon caps, actuators, bezels & bezel inserts. To specify, add selected color code to part number. Example: A2122 is a black A212 Cap. To specify for actuators, bezels and bezel inserts, see 'Order Format' section following specific series information in this catalog.

| Code | Color | Code | Color |
|------|--------|------|-------|
| 1 | blue | 2 | black |
| 3 | green | 4 | gray |
| 5 | yellow | 6 | red |
| 7 | ivory | 8 | white |
| 9 | orange | | |

MISCELLANEOUS PUSHBUTTON ACCESSORIES & CAPS (CONT'D.)

COLOR CAP B494



** - P1 fits all 800 Series except K1M & K1S.
 * - P2 fits all 300 & 400 Series.
 * - P3 fits all PB Series.

PUSHBUTTON CAP A631



* - Fits all 300 Series except 301 & 305. Fits 301 & 305 with S option. Fits all 400 & PB Series.
 ** - Fits 800 Series with options KM, KS, KM1 & K2M1.

PUSHBUTTON CAP A632



Fits all PB Series.

CUSTOM MARKING

Permanent ink marking is available for switch caps, bezels and rocker actuators. Consult factory with your special requirement. Representative samples available.

SWITCH GUARDS

Materials: 5056-H18 aluminum with clear or black anodize, or free machining brass with bright chrome plate.
 Dimensions in inches and (millimeters). Tolerances: A & D, ±.015" B & C, ±.005"

| MODEL | TH'D. | COLOR | FINISH | A | B | C | D |
|--------|--------|-------------|---------|-------------|-------------|------------|------------|
| MG11A | 10-48 | NATURAL AL. | PLAIN | | | | |
| MG11B | 10-48 | BLACK AL. | PLAIN | | | | |
| MG12A | 1/4-40 | NATURAL AL. | PLAIN | | | | |
| MG12B | 1/4-40 | BLACK AL. | PLAIN | .530 (13.5) | .413 (10.5) | .315 (8.0) | .236 (6.0) |
| MG12C | 1/4-40 | CHROMED BR. | PLAIN | | | | |
| MG12KA | 1/4-40 | NATURAL AL. | KNURLED | | | | |
| MG12KB | 1/4-40 | BLACK AL. | KNURLED | | | | |
| MG12KC | 1/4-40 | CHROMED BR. | KNURLED | | | | |
| MG13A | 1/4-40 | NATURAL AL. | PLAIN | | | | |
| MG13B | 1/4-40 | BLACK AL. | PLAIN | .730 (18.5) | .610 (15.5) | .315 (8.0) | .236 (6.0) |
| MG13C | 1/4-40 | CHROMED BR. | PLAIN | | | | |

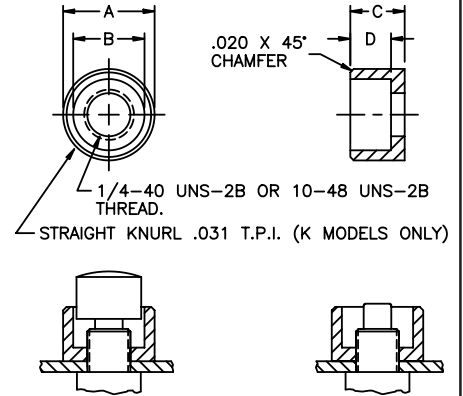

STANDARD COLOR CODE

For nylon caps, actuators, bezels & bezel inserts.
 To specify, add selected color code to part number. Example: A2122 is a black A212 Cap. To specify for actuators, bezels and bezel inserts, see 'Order Format' section following specific series information in this catalog.

| Code | Color | Code | Color |
|------|--------|------|-------|
| 1 | blue | 2 | black |
| 3 | green | 4 | gray |
| 5 | yellow | 6 | red |
| 7 | ivory | 8 | white |
| 9 | orange | | |

CAPS FOR PRINTED CIRCUIT BOARD PROCESSING

Available on models with plain bushing.
 Supplied mounted on switches or separately.
 Provides additional protection during pcb processing.

| Outline | Series | Material | Part No. |
|---------|--------|----------|----------|
| | S | Vinyl | U3012 |
| | TP | Vinyl | U3502 |

SPECIFICATIONS SUBJECT TO CHANGE WITHOUT NOTICE

D

SECURITY GUARDS for switch series 12000, 3500, 600H and 6000

FEATURES

- Security guards prevent inadvertent switch operation.
- When guard cap is raised, switch actuator operates freely.
- When guard cap is depressed, switch actuator is locked in set position.
- Designed for use on switches with 11.9mm (.468") or 12mm (.472") dia. threaded bushings and actuator length 17.5mm (.688") outside bushing .
- Adjust guard for correct switch operation with 2 nuts.



MATERIALS

Support plate: Matte black steel
Cap: Thermoset plastic

Series 20 - for 2 position switches

Actuator returned then locked in down position (OFF)

| MODEL NO. | COLOR |
|-----------|----------------------|
| 22 | Gray |
| 23 | White |
| 24 | Orange |
| 25 | Black |
| 26 | Red |
| 27 | Green |
| 28 | Yellow |
| 25/28 | Black/yellow striped |



Series 30 - for 3 position switches

Actuator returned then locked in upper position

| MODEL NO. | COLOR |
|-----------|----------------------|
| 32 | Gray |
| 33 | White |
| 34 | Orange |
| 35 | Black |
| 36 | Red |
| 37 | Green |
| 38 | Yellow |
| 39 | Yellow |
| 35/38 | Black/yellow striped |



Series 40 - for 2 position switches

Actuator returned then locked in upper position

| MODEL NO. | COLOR |
|-----------|----------------------|
| 42 | Gray |
| 43 | White |
| 44 | Orange |
| 45 | Black |
| 46 | Red |
| 47 | Green |
| 48 | Yellow |
| 49 | Blue |
| 45/48 | Black/yellow striped |



SPECIFICATIONS SUBJECT TO CHANGE WITHOUT NOTICE

D

SECURITY GUARDS for switch series 12000, 3500, 600H and 6000

Series 50 - for 2 position switches

Actuator returned then locked in down position (OFF)

| MODEL NO. | COLOR |
|-----------|----------------------|
| 52 | Gray |
| 53 | White |
| 54 | Orange |
| 55 | Black |
| 56 | Red |
| 57 | Green |
| 58 | Yellow |
| 59 | Blue |
| 55/58 | Black/yellow striped |



Series 60 - for 3 position switches

Actuator returned then locked in upper position

| MODEL NO. | COLOR |
|-----------|----------------------|
| 62 | Gray |
| 63 | White |
| 64 | Orange |
| 65 | Black |
| 66 | Red |
| 67 | Green |
| 68 | Yellow |
| 69 | Blue |
| 65/68 | Black/yellow striped |



Series 70 - for 2 position switches

Actuator returned then locked in upper position

| MODEL NO. | COLOR |
|-----------|----------------------|
| 72 | Gray |
| 73 | White |
| 74 | Orange |
| 75 | Black |
| 76 | Red |
| 77 | Green |
| 78 | Yellow |
| 79 | Yellow |
| 75/78 | Black/yellow striped |



Series 20PN - for 2 position switches

Actuator returned then locked in down position (OFF)
Option P - holes for wiring seal standard on this model

| MODEL NO. | COLOR |
|-----------|--------|
| 22PN | Gray |
| 23PN | White |
| 24PN | Orange |
| 25PN | Black |
| 26PN | Red |
| 27PN | Green |
| 28PN | Yellow |
| 29PN | Blue |



D

SPECIFICATIONS SUBJECT TO CHANGE WITHOUT NOTICE

SECURITY GUARDS for switch series 12000, 3500, 600H and 6000

PANEL CUT-OUTS & OPTIONS



P Holes for wiring seal

Cap engraving available - consult factory.
Other locking configurations such as locked center position available - consult factory.

SECURITY GUARDS for switch series 3500, 600H and 6000

Series 90
Actuator locked in center position



Bushing shapes - for standard products



- for other products



Security guard cap shape



1
Locks in center position



2
Prevents down position



3
Prevents up position



4
Locks in down position



5
Locks in up position

Security guard cap colors

| OPTION | COLOR |
|--------|--------------------------------|
| 1 | Blue |
| 2 | Black |
| 3 | Green |
| 4 | Gray |
| 5 | Yellow |
| 6 | Red |
| 7/1 | White |
| 9 | Orange |
| 0 | Striped (see color of stripes) |

Color of stripes

| OPTION | STRIPE 1 | STRIPE 2 |
|--------|----------|----------|
| A | Red | Black |
| B | Yellow | Black |
| C | Red | White |
| D | White | Black |



How to order

Series Bushing shape Cap shape Cap color Color of stripes



Fill in boxes by making selections from each category indicated.

Example of completely specified model number:

90A10B

SPECIFICATIONS SUBJECT TO CHANGE WITHOUT NOTICE

D

SEALING BOOTS FOR SWITCHES

FEATURES

- Prevents dust, sand and water from entering switches.
- Prevents ice from blocking actuator movement on toggle switches.
- Compatible with internally sealed toggle and pushbutton actuators.
- Available in a wide range of colors .
- Each boot is supplied with a sealing ring or washer.

MATERIALS AND SPECIFICATIONS

Boot material: Neoprene or silicone (see comparative advantages below)
Nut material: Nickel plated or matte black finished brass
Operating temperature: Neoprene; -20°C to 50°C -40°C to 85°C

| Comparative Advantages | Temperature Range | | Elasticity | Mechanical Resistance |
|------------------------|-------------------|-----------|------------|-----------------------|
| | Low | High | | |
| Silicone | Excellent | Excellent | Excellent | Poor |
| Neoprene | Poor | Good | Poor | Excellent |

TYPES OF BOOTS - CROSS SECTIONS

* Color options available



EXAMPLES OF MOUNTING



For toggle bushing 6 x 0.75 (.236 x 0.75) - 5500 series



| NUT | FULL TOGGLE SILICONE BOOTS | | | |
|---------------------------------|----------------------------|---------|---------|---------|
| | Black | Red | Green | White |
| Knurled Nickel plated | U1341 | U1341-6 | U1341-3 | U1341-7 |
| Knurled Matte black | U1343 | U1343-6 | U1343-3 | U1343-7 |
| Hex Nickel plated | U1302 | U1302-6 | U1302-3 | U1302-7 |
| Hex Matte black | U1304 | U1304-6 | U1304-3 | U1304-7 |



SEALING BOOTS FOR SWITCHES

For toggle bushing 6,35-40NS (1/4-40NS) - 5000 and 11000 series



| NUT | FULL TOGGLE SILICONE BOOTS | | | |
|---------------------------------|----------------------------|---------|---------|---------|
| | Black | Red | Green | White |
| Knurled Nickel plated | U1331 | U1331-6 | U1331-3 | U1331-7 |
| Knurled Matte black | U1333 | U1333-6 | U1333-3 | U1333-7 |
| Hex Nickel plated | U1229 | U1229-6 | U1229-3 | U1229-7 |
| Hex Matte black | U1231 | U1231-6 | U1231-3 | U1231-7 |



For toggle bushing 6,35-40NS (1/4-40NS) - 5000 and 11000 series



| NUT | SILICONE BOOTS (supplied as 2 separate parts) | | | |
|-----|---|---------|---------|---------|
| | Black | Red | Green | White |
| | U5149 | U5149-6 | U5149-3 | U5149-7 |

When boot is mounted onto panel, metal parts of switch are completely covered by insulation.



For toggle bushing 10 x 0.75 (.393 x 0.75) - 10600 series



| KNURLED NUT | FULL TOGGLE SILICONE BOOTS | | | |
|---------------|----------------------------|---------|---------|---------|
| | Black | Red | Green | White |
| Nickel plated | U1612 | U1612-6 | U1612-3 | U1612-7 |
| Matte black | U1614 | U1614-6 | U1614-3 | U1614-7 |



For toggle bushing 11,9-32 (15/32-32NS) - 12000, 3500 and 6000 series



| HEX NUT | FULL TOGGLE SILICONE BOOTS | | | |
|---------------|----------------------------|---------|---------|---------|
| | Black | Red | Green | White |
| Nickel plated | U1031 | U1031-6 | U1031-3 | U1031-7 |
| Matte black | U1024 | U1024-6 | U1024-3 | U1024-7 |



SPECIFICATIONS SUBJECT TO CHANGE WITHOUT NOTICE

D

SEALING BOOTS FOR SWITCHES

For toggle bushing 11,9-32NS (15/32-32NS) - 12000, 3500 and 6000 series



| HEX NUT | HALF TOGGLE SILICONE BOOTS | | | |
|---------------|----------------------------|---------|---------|---------|
| | Black | Red | Green | White |
| Nickel plated | U1600 | U1600-6 | U1600-3 | U1600-7 |
| Matte black | U1602 | U1602-6 | U1602-3 | U1602-7 |



D

For toggle bushing 12 X 0.75 SI (.472 X 0.75 IS) - 4450, 4650 and 1600 series



| HEX NUT | FULL TOGGLE BLACK NEOPRENE BOOTS |
|---------------|----------------------------------|
| Nickel plated | U09 |
| Matte black | U223 |



For toggle bushing 12 x 0.75 SI (.472 x 0.75 IS) - 400, 500, 600H, 6-600H, 600SH, 660, 1000, 1500 and 3600 series



| HEX NUT | FULL TOGGLE SILICONE BOOTS | | | |
|---------------|----------------------------------|---------|---------|---------|
| | Black | Red | Green | White |
| Nickel plated | U1565 | U1565-6 | U1565-3 | U1565-7 |
| Matte black | U1567 | U1567-6 | U1567-3 | U1567-7 |
| | FULL TOGGLE BLACK NEOPRENE BOOTS | | | |
| Nickel plated | U851 | | | |
| Matte black | U853 | | | |



For toggle bushing 12 x 0.75 SI (.472 x 0.75 IS) - 400, 500, 600H, 6-600H, 660, 1000 and 3600 series



| HEX NUT | HALF TOGGLE SILICONE BOOTS | | | |
|---------------|----------------------------------|---------|---------|---------|
| | Black | Red | Green | White |
| Nickel plated | U1151 | U1151-6 | U1151-3 | U1151-7 |
| Matte black | U1153 | U1153-6 | U1153-3 | U1153-7 |
| | HALF TOGGLE BLACK NEOPRENE BOOTS | | | |
| Nickel plated | U598 | | | |
| Matte black | U600 | | | |



SPECIFICATIONS SUBJECT TO CHANGE WITHOUT NOTICE

SEALING BOOTS FOR SWITCHES

For pushbutton bushing 4 x 0.70 (.157 x 0.70) - 9500 series



| HEX NUT | PUSHBUTTON SILICONE BOOTS | | | |
|---------------|---------------------------|---------|---------|---------|
| | Black | Red | Green | White |
| Nickel plated | U1829 | U1829-6 | U1829-3 | U1829-7 |
| Matte black | U1831 | U1831-6 | U1831-3 | U1831-7 |



For pushbutton bushing 6,35-40NS (1/4-40NS) - 18000, 9000 and 13000 series



| NUT | PUSHBUTTON SILICONE BOOTS | | | |
|----------------|---------------------------|---------|---------|---------|
| | Black | Red | Green | White |
| Knurled | | | | |
| Nickel plated | U1401 | U1401-6 | U1401-3 | U1401-7 |
| Knurled | | | | |
| Matte black | U1403 | U1403-6 | U1403-3 | U1403-7 |
| Hex | | | | |
| Nickel plated | U1318 | U1318-6 | U1318-3 | U1318-7 |
| Hex | | | | |
| Matte black | U1320 | U1320-6 | U1320-3 | U1320-7 |



For pushbutton bushing 10 x 0.75 (.393 x 0.75) - 10400 series



| KNURLED NUT | PUSHBUTTON SILICONE BOOTS | | | |
|---------------|---------------------------|---------|---------|---------|
| | Black | Red | Green | White |
| Nickel plated | U1624 | U1624-6 | U1624-3 | U1624-7 |
| Matte black | U1626 | U1626-6 | U1626-3 | U1626-7 |



For pushbutton bushing 11,9-32NS (15/32-32NS) - 13000X778 and 13000X768 series



| HEX NUT | PUSHBUTTON SILICONE BOOTS | | | |
|---------------|---------------------------|--------|--------|--------|
| | Black | Red | Green | White |
| Nickel plated | U589 | U589-6 | U589-3 | U589-7 |
| Matte black | U590 | U590-6 | U590-3 | U590-7 |



SPECIFICATIONS SUBJECT TO CHANGE WITHOUT NOTICE

D

SEALING BOOTS FOR SWITCHES

For pushbutton bushing 12 x 0.75 SI (.472 x 0.75) - 1200, 4700 and 4800 series



| HEX NUT | PUSHBUTTON SILICONE BOOTS | | | |
|---------------|---------------------------------|---------|---------|---------|
| | Black | Red | Green | White |
| Nickel plated | U1654 | U1654-6 | U1654-3 | U1654-7 |
| Matte black | U1656 | U1656-6 | U1656-3 | U1656-7 |
| | PUSHBUTTON BLACK NEOPRENE BOOTS | | | |
| Nickel plated | U31 | | | |
| Matte black | U225 | | | |
| Chrome plated | U224 | | | |



D

For double sealing IP series



TRANSPARENT SILICONE BOOT
U5125



For external sealing on A02 series

SILICONE BOOT
A02WPC



For 2600 series rocker switches



TRANSPARENT SILICONE BOOT
U2150



SPECIFICATIONS SUBJECT TO CHANGE WITHOUT NOTICE

VL SERIES LED INDICATORS

FEATURES

- Indicators with red, yellow or green built-in LED.
- Flatted bushing for anti-rotation.
- 2 bushing diameters: 6mm (.236") and 8mm (.314").
- Sealed and unsealed models.
- Bright chrome or matte black plated finishes.

SPECIFICATIONS

| | |
|---------------------------------------|--|
| Insulation resistance: | 1000 megohms min. |
| Dielectric strength: | 250 Vrms, 50 Hz min. |
| Electric life at high temperature: | 72 hours at 85°C |
| Torque: | 1.25 Nm (.922 ft.lb.) max.applied to nut |
| Climatic category: | 40/085/21 |
| Protection level (sealed models): | IP67 per IEC 529 |
| In accordance with NFC 93680 standard | |

LED SPECIFICATIONS

(T ambient = 25°C)

| | |
|-------------------------|---------------------------|
| Forward voltage: | 2VDC ($\leq 2.6V$) |
| Nominal current: | 10mA |
| Max. surge current: | 0.5 A ($t_p < 10\mu s$) |
| Max. reversed voltage: | 25V |
| Max. forward current: | 40mA |
| Max. power dissipation: | 100mW |

MATERIALS

| | |
|---------------------|---|
| Bushing and collar: | Brass, bright or matte black chrome plated |
| Lens: | Polycarbonate |
| Hardware supplied: | 1 nickel plated brass hex nut; 9mm (.354") across flats for 6mm (.236") dia. indicator or 10mm (.393") across flats for 8mm (.314") dia. indicator. |

SPECIFICATIONS SUBJECT TO CHANGE WITHOUT NOTICE

D

6mm (.236") diameter - unsealed



| LED COLOR | BRIGHT FINISH | MATTE BLACK FINISH |
|-----------|---------------|--------------------|
| Red | VL1000P600 | VL100GP600 |
| Yellow | VL1000P500 | VL100GP500 |
| Green | VL1000P300 | VL100GP300 |

Note: Bright finish is standard.

Arrow indicates bushing flat. Option: bushing without flat and lockwasher- on request



8mm (.314") diameter - unsealed



| LED COLOR | BRIGHT FINISH | MATTE BLACK FINISH |
|-----------|---------------|--------------------|
| Red | VL3000P600 | VL300GP600 |
| Yellow | VL3000P500 | VL300GP500 |
| Green | VL3000P300 | VL300GP300 |

Note: Bright finish is standard.

Arrow indicates bushing flat. Option: bushing without flat and lockwasher- on request



VL SERIES LED INDICATORS

6mm (.236") diameter - sealed



| LED COLOR | BRIGHT FINISH | MATTE BLACK FINISH |
|-----------|---------------|--------------------|
| Red | VL1CK0P600 | VL1CKGP600 |
| Yellow | VL1CK0P500 | VL1CKGP500 |
| Green | VL1CK0P300 | VL1CKGP300 |

Notes: Bright finish is standard. Lens cap is the same color as the LED.

Arrow indicates bushing flat. Option: bushing without flat and lockwasher- on request



D

8mm (.314") diameter - sealed



| LED COLOR | BRIGHT FINISH | MATTE BLACK FINISH |
|-----------|---------------|--------------------|
| Red | VL3CK0P600 | VL3CKGP600 |
| Yellow | VL3CK0P500 | VL3CKGP500 |
| Green | VL3CK0P300 | VL3CKGP300 |

Note: Bright finish is standard. Lens cap is the same color as the LED.

Arrow indicates bushing flat. Option: bushing without flat and lockwasher- on request



LED'S

Observe polarity of DC supply to LED's. Longer lead is anode (+). Shorter lead is cathode (-) on flat side of bushing (see drawing).

LED's are not removable.

LED's per customer specifications that meet drawings shown can be supplied - consult factory.



For 6mm (.236") indicators



For 8mm (.314") indicators

STANDARD HARDWARE AND PANEL CUT-OUTS



For 6mm (.236") indicators

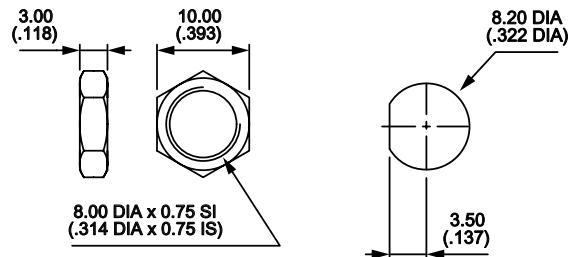

For 8mm (.314") indicators

SPECIFICATIONS SUBJECT TO CHANGE WITHOUT NOTICE

Данный компонент на территории Российской Федерации

Вы можете приобрести в компании MosChip.

Для оперативного оформления запроса Вам необходимо перейти по данной ссылке:

<http://moschip.ru/get-element>

Вы можете разместить у нас заказ для любого Вашего проекта, будь то серийное производство или разработка единичного прибора.

В нашем ассортименте представлены ведущие мировые производители активных и пассивных электронных компонентов.

Нашей специализацией является поставка электронной компонентной базы двойного назначения, продукции таких производителей как XILINX, Intel (ex.ALTERA), Vicor, Microchip, Texas Instruments, Analog Devices, Mini-Circuits, Amphenol, Glenair.

Сотрудничество с глобальными дистрибьюторами электронных компонентов, предоставляет возможность заказывать и получать с международных складов практически любой перечень компонентов в оптимальные для Вас сроки.

На всех этапах разработки и производства наши партнеры могут получить квалифицированную поддержку опытных инженеров.

Система менеджмента качества компании отвечает требованиям в соответствии с ГОСТ Р ИСО 9001, ГОСТ РВ 0015-002 и ЭС РД 009

Офис по работе с юридическими лицами:

105318, г.Москва, ул.Щербаковская д.3, офис 1107, 1118, ДЦ «Щербаковский»

Телефон: +7 495 668-12-70 (многоканальный)

Факс: +7 495 668-12-70 (доб.304)

E-mail: info@moschip.ru

Skype отдела продаж:

moschip.ru

moschip.ru_4

moschip.ru_6

moschip.ru_9