

EAO – Your Expert Partner for
Human Machine Interfaces

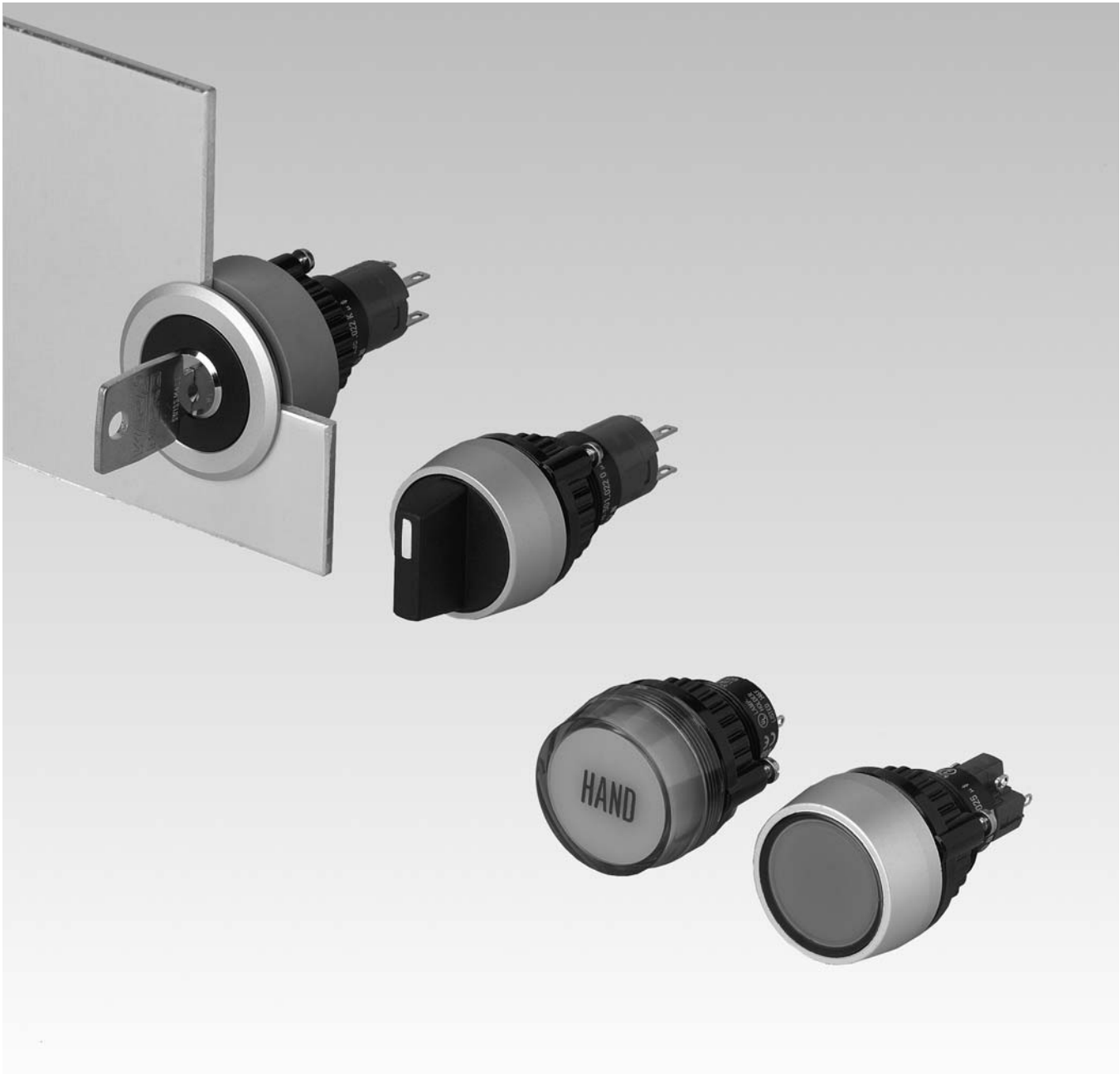

EAO Product Information

Series 14



Description	3
Product Assembly	4
Devices raised mounting	6
Devices flush mounting	13
Accessories.....	17
Technical Data.....	27
Typical Applications	30
Application guidelines.....	31
Marking	32
Drawings.....	36
Index.....	56

Product Information

General notes

The Series 14 illuminated pushbuttons combine the robust actuators of the Series 04 with choice of either snap-action switching elements with gold plated silver contacts for one changeover only.

These pushbuttons have an IP 67 proof front (temporary emersion) and can be immersed to a depth of one metre.

The range includes pushbuttons, keylock switches and selector switches.

Anodized aluminium parts can have visible variations due production-technical reasons.

Mounting

Mounted from the front through either 22.5 mm dia cut out for raised or 30.5 mm dia for flush.

The pushbuttons are secured to the panel by means of a fixing ring/ nut and prevented from twisting by two screws.

To ensure correct positioning of the pushbuttons we can provide a positioning insert if required.

The Low Level switching elements with universal terminals allow them to PCB mounted. These terminals are also suitable for dip soldering. A plug-in base is available, which when soldered to the board allows the switch to be easily plugged-in.

Lenses

Lenses of transparent plastic or aluminium are available in various standard colours.

Marking

For further information about engraving, hot stamping and film inserts see part Marking.

Illumination

The T5.5 incandescent (filament) lamp (6, 12, 24, 28, 30, 36, 48 V) ensures perfect illumination of the lenses, which are supplied in various colours.

T5.5 Single-Chip LED (6, 12, 24, 28, 48 V) are also available in blue, green, red, white or yellow.

Do not solder the terminals directly, because of the high surface temperature.

Luminosity and wave length scattering caused by the technology used in the LED manufacturing processes may lead to visual differences in our products.

Position indication

The status of a maintained action switch can be determined by the position of the lens.

Keylock switch

Single locks (2 positions).

There are 10 different locks with standard numbers 1001 ... 1010. If the lock number is not specified, we will supply standard number 1001.

Additional lock numbers are available on request.

Two keys are supplied with each keylock switch.

Spare keys for standard locks may be ordered by quoting Typ-Nr.

14-987 (please state the lock number).

Specimen order

Illuminated pushbutton :

- Illuminated pushbutton actuator, 29 mm dia., snap-action switching element, 1NC + 1 NO, momentary action, soldering terminal 14-131.0252

Essential accessories :

- Lens plastic red 704.602.2
- Marking plate white translucent 704.609.9
- Front ring aluminium natural 704.600.1
- Single-LED, T5.5, 12 VAC/DC, white 10-2109.1069

*We reserve the right to modify technical data
All dimensions in mm*

Illuminated pushbutton, raised mounting

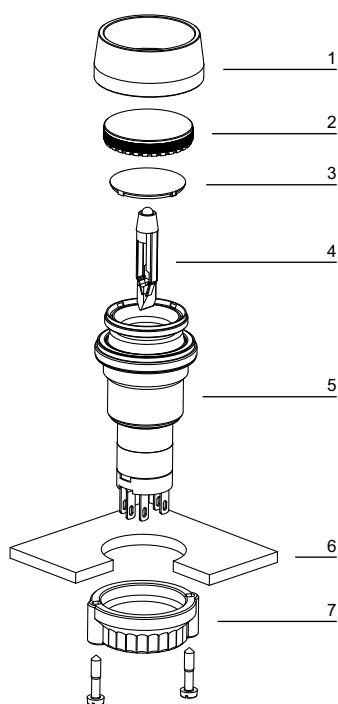

- 1 Front ring
- 2 Lens
- 3 Marking plate
- 4 LED
- 5 Actuator housing with switching element
- 6 Front plate
- 7 Fixing nut

Illuminated pushbutton, flush mounting

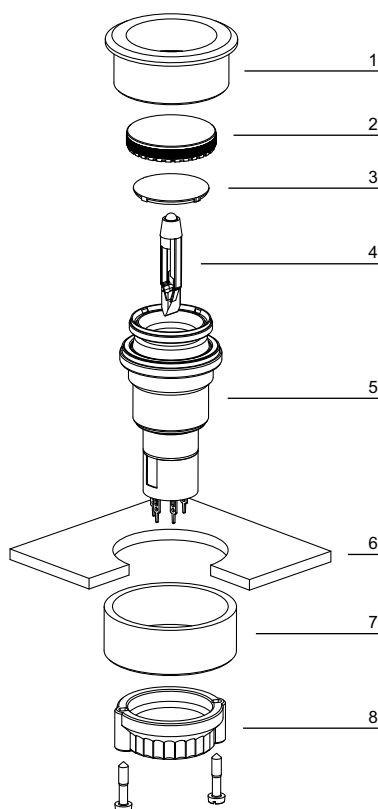

- 1 Front bezel set, flush mounting
- 2 Lens
- 3 Marking plate
- 4 LED
- 5 Actuator housing with switching element
- 6 Front panel
- 7 Pressure ring
- 8 Fixing nut

Keylock switch, raised mounting

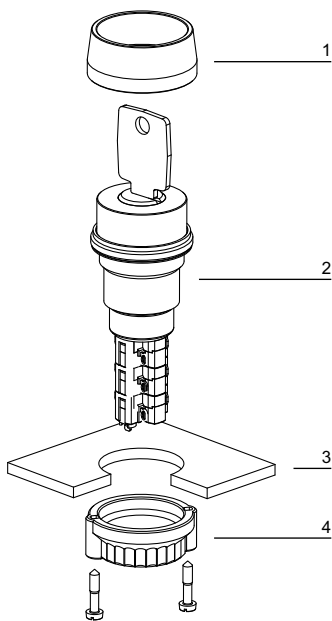

- 1 Front ring
- 2 Actuator housing with switching element
- 3 Front plate
- 4 Fixing nut

Selector switch, flush mounting

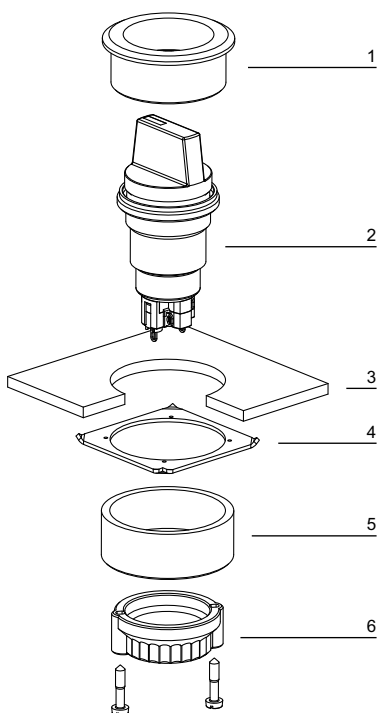



- 1 Front ring
- 2 Actuator housing with switching element
- 3 Front plate
- 4 Anti-twist ring
- 5 Pressure ring
- 6 Fixing nut

Indicator actuator full face illumination



Essential Accessories:

-  Lens cap page 18
-  Marking cap for Lens cap page 19
-  Single-LED page 24

	Front protection	Diode (1N 4007)	Terminals	Ø 29 mm Typ-Nr.	Component layout	Mounting dimensions	Technical drawing	Circuit drawing	
Indicator actuator full face illumination	IP 67	1 D	UT	14-741.006	2	5	17	56	0.011
		2 D	UT	14-742.006	2	5	17	57	0.011
	-	S		14-030.005		5	17	3	0.010
		S1		14-030.002		5	17	3	0.010
		UT		14-031.006	2	5	17	2	0.011

Diode (1N 4007): D = Diode, - = without





Terminals: UT = Universal terminal, S = Soldering terminal, S1 = Soldering terminal (also pluggable 2.8 x 0.5 mm)

Component layout from page 36, Mounting dimensions from page 37, Technical drawing from page 38, Circuit drawing from page 48

Indicator actuator front illumination



Essential Accessories:

-  Front ring page 19
-  Lens plastic page 17
-  Marking plate for Lens plastic and metal page 18
-  Single-LED page 24

	Front protection	Terminals	Ø 29 mm Typ-Nr.	Component layout	Mounting dimensions	Technical drawing	Circuit drawing	
Indicator actuator front illumination	IP 67	S	14-040.005		5	19	3	0.050
		S1	14-040.002		5	19	3	0.050
		UT	14-041.006	2	5	19	2	0.050

Terminals: S = Soldering terminal, S1 = Soldering terminal (also pluggable 2.8 x 0.5 mm), UT = Universal terminal

Component layout from page 36, Mounting dimensions from page 37, Technical drawing from page 38, Circuit drawing from page 48

Buzzer



	Front protection	Front cap	Terminals	Ø 29 mm Typ-Nr.	Mounting dimensions	Technical drawing	Circuit drawing	
Buzzer Operation voltage 24 VDC	IP 65	Brass nickel-plated	S1	14-810.902	5	1	1	0.016
		Plastic black	S1	14-810.002	5	1	1	0.016

Further information in the Technical Data and Typical Applications

Terminals: S1 = Soldering terminal (also pluggable 2.8 x 0.5 mm)

Mounting dimensions from page 37, Technical drawing from page 38, Circuit drawing from page 48

Illuminated actuator pushbutton



Essential Accessories:

- Front ring page 19
- Lens plastic page 17
- Marking plate for Lens plastic and metal page 18
- Single-LED page 24

	Front protection	Switching system	Contacts	Diode (1N 4007)	Switching action	Terminals	Ø 29 mm Typ-Nr.	Component layout	Mounting dimensions	Technical drawing	Circuit drawing		
Illuminated actuator pushbutton	IP 67	LL	1 NC	-	MA	UT	14-476.036	2	5	20	12	0.015	
					M	UT	14-436.036	2	5	20	39	0.015	
			1 NC + 1 NO	-	MA	UT	14-473.036	2	5	20	15	0.015	
					M	UT	14-433.036	2	5	20	42	0.015	
			1 NO	-	MA	UT	14-475.036	2	5	20	14	0.015	
					M	UT	14-435.036	2	5	20	41	0.015	
			2 NC	-	MA	UT	14-472.036	2	5	20	13	0.015	
					M	UT	14-432.036	2	5	20	40	0.015	
			2 NO	-	MA	UT	14-471.036	2	5	20	16	0.015	
					M	UT	14-431.036	2	5	20	43	0.015	
			SA	1 NC + 1 NO	1 D	MA	UT	14-747.0292	2	5	20	9	0.014
						M	UT	14-743.0292	2	5	20	36	0.014
		2 D			MA	UT	14-748.0292	2	5	20	10	0.014	
					M	UT	14-744.0292	2	5	20	37	0.014	
		-			MA	S	14-271.0252		5	20	11	0.013	
						S1	14-271.022		5	20	11	0.013	
					M	S	14-131.0252		5	20	38	0.013	
						S1	14-131.022		5	20	38	0.013	
		2 NC + 2 NO			1 D	MA	UT	14-749.0292	2	5	20	6	0.016
						M	UT	14-745.0292	2	5	20	33	0.016
					2 D	MA	UT	14-750.0292	2	5	20	7	0.016
						M	UT	14-746.0292	2	5	20	34	0.016
		-	MA	S	14-272.0252		5	20	8	0.015			
				M	S	14-132.0252		5	20	35	0.015		
3 NC + 3 NO	-	MA	S	14-273.0252		5	20	5	0.017				
		M	S	14-133.0252		5	20	32	0.017				
4 NC + 4 NO	-	MA	S	14-274.0252		5	20	4	0.019				
		M	S	14-134.0252		5	20	31	0.019				

Switching system: LL = Low level switching element, SA = Snap-action switching element

Contacts: NC = Normally closed, NO = Normally open

Diode (1N 4007): - = without, D = Diode

Switching action: MA = Maintained action, M = Momentary action

Terminals: UT = Universal terminal, S = Soldering terminal, S1 = Soldering terminal (also pluggable 2.8 x 0.5 mm)

Component layout from page 36, Mounting dimensions from page 37, Technical drawing from page 38, Circuit drawing from page 48

Mushroom-head actuator pushbutton



Essential Accessories:

- Front ring page 19
- Marking plate for Mushroom-head cap page 18
- Mushroom-head cap page 18

	Front protection	Switching system	Contacts	Switching action	Terminals	Ø 40 mm Typ-Nr.	Component layout	Mounting dimensions	Technical drawing	Circuit drawing		
Mushroom-head actuator pushbutton	IP 67	LL	1 NC	MA	UT	14-476.036	2	2	18	12	0.015	
				M	UT	14-436.036	2	2	18	39	0.015	
			1 NC + 1 NO	MA	UT	14-473.036	2	2	18	15	0.015	
				M	UT	14-433.036	2	2	18	42	0.015	
			1 NO	MA	UT	14-475.036	2	2	18	14	0.015	
				M	UT	14-435.036	2	2	18	41	0.015	
			2 NC	MA	UT	14-472.036	2	2	18	13	0.015	
				M	UT	14-432.036	2	2	18	40	0.015	
			2 NO	MA	UT	14-471.036	2	2	18	16	0.015	
				M	UT	14-431.036	2	2	18	43	0.015	
			SA	1 NC + 1 NO	MA	S	14-271.0252		2	18	11	0.013
						S1	14-271.022		2	18	11	0.013
		M			S	14-131.0252		2	18	38	0.013	
					S1	14-131.022		2	18	38	0.013	
		2 NC + 2 NO	MA	S	14-272.0252		2	18	8	0.015		
			M	S	14-132.0252		2	18	35	0.015		
		3 NC + 3 NO	MA	S	14-273.0252		2	18	5	0.017		
			M	S	14-133.0252		2	18	32	0.017		
		4 NC + 4 NO	MA	S	14-274.0252		2	18	4	0.019		
			M	S	14-134.0252		2	18	31	0.019		

Switching system: LL = Low level switching element, SA = Snap-action switching element

Contacts: NC = Normally closed, NO = Normally open

Switching action: MA = Maintained action, M = Momentary action





Terminals: UT = Universal terminal, S = Soldering terminal, S1 = Soldering terminal (also pluggable 2.8 x 0.5 mm)

Component layout from page 36, Mounting dimensions from page 37, Technical drawing from page 38, Circuit drawing from page 48

Illuminated mushroom-head actuator pushbutton



Essential Accessories:

-  Front ring page 19
-  Marking plate for Mushroom-head cap page 18
-  Mushroom-head cap illuminated page 18
-  Single-LED page 24

	Front protection	Switching system	Contacts	Diode (1N 4007)	Switching action	Terminals	Ø 40 mm Typ-Nr.	Component layout	Mounting dimensions	Technical drawing	Circuit drawing		
Illuminated mushroom-head actuator pushbutton	IP 67	LL	1 NC	-	MA	UT	14-476.036	2	2	18	12	0.015	
					M	UT	14-436.036	2	2	18	39	0.015	
			1 NC + 1 NO	-	MA	UT	14-473.036	2	2	18	15	0.015	
					M	UT	14-433.036	2	2	18	42	0.015	
			1 NO	-	MA	UT	14-475.036	2	2	18	14	0.015	
					M	UT	14-435.036	2	2	18	41	0.015	
			2 NC	-	MA	UT	14-472.036	2	2	18	13	0.015	
					M	UT	14-432.036	2	2	18	40	0.015	
			2 NO	-	MA	UT	14-471.036	2	2	18	16	0.015	
					M	UT	14-431.036	2	2	18	43	0.015	
			SA	1 NC + 1 NO	1 D	MA	UT	14-747.0292	2	2	18	9	0.014
						M	UT	14-743.0292	2	2	18	36	0.014
		2 D			MA	UT	14-748.0292	2	2	18	10	0.014	
					M	UT	14-744.0292	2	2	18	37	0.014	
		-			MA	S	14-271.0252		2	18	11	0.013	
						S1	14-271.022		2	18	11	0.013	
					M	S	14-131.0252		2	18	38	0.013	
						S1	14-131.022		2	18	38	0.013	
		2 NC + 2 NO			1 D	MA	UT	14-749.0292	2	2	18	6	0.016
						M	UT	14-745.0292	2	2	18	33	0.016
					2 D	MA	UT	14-750.0292	2	2	18	7	0.016
						M	UT	14-746.0292	2	2	18	34	0.016
			-	MA	S	14-272.0252		2	18	8	0.015		
				M	S	14-132.0252		2	18	35	0.015		
		3 NC + 3 NO	-	MA	S	14-273.0252		2	18	5	0.017		
				M	S	14-133.0252		2	18	32	0.017		
		4 NC + 4 NO	-	MA	S	14-274.0252		2	18	4	0.019		
				M	S	14-134.0252		2	18	31	0.019		

Switching system: LL = Low level switching element, SA = Snap-action switching element

Contacts: NC = Normally closed, NO = Normally open

Diode (1N 4007): - = without, D = Diode

Switching action: MA = Maintained action, M = Momentary action

Terminals: UT = Universal terminal, S = Soldering terminal, S1 = Soldering terminal (also pluggable 2.8 x 0.5 mm)

Component layout from page 36, Mounting dimensions from page 37, Technical drawing from page 38, Circuit drawing from page 48

Keylock switch 2 positions

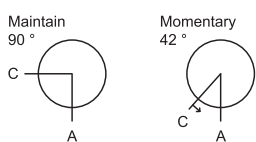

	Front protection	Front ring	Switching system	Contacts	Switching action	Terminals	Key remove	Ø 29 mm Typ-Nr.	Component layout	Mounting dimensions	Technical drawing	Circuit drawing	
Keylock switch 2 positions Position A : Basic position Position C : Maintained action Standard lock 1001, Front : Plastic black	IP 65	Aluminium natural	LL	1 NC + 1 NO	MA	UT	A	14-415.036K	2	5	21	54	0.030
							C	14-418.036K	2	5	21	54	0.030
							C + A	14-412.036K	2	5	21	54	0.030
				2 NO	MA	UT	A	14-414.036K	2	5	21	55	0.030
							C	14-417.036K	2	5	21	55	0.030
							C + A	14-411.036K	2	5	21	55	0.030
			SA	1 NC + 1 NO	MA	S	A	14-235.025K2		5	21	50	0.029
							C	14-335.025K2		5	21	50	0.029
							C + A	14-135.025K2		5	21	50	0.029
						S1	A	14-235.022K		5	21	50	0.029
							C	14-335.022K		5	21	50	0.029
							C + A	14-135.022K		5	21	50	0.029
				2 NC + 2 NO	MA	S	A	14-236.025K2		5	21	51	0.031
							C	14-336.025K2		5	21	51	0.031
							C + A	14-136.025K2		5	21	51	0.031
				3 NC + 3 NO	MA	S	A	14-237.025K2		5	21	52	0.033
							C	14-337.025K2		5	21	52	0.033
							C + A	14-137.025K2		5	21	52	0.033
4 NC + 4 NO	MA	S	A	14-238.025K2		5	21	53	0.035				
			C	14-338.025K2		5	21	53	0.035				
			C + A	14-138.025K2		5	21	53	0.035				
Position A : Basic position Position C : Momentary action Standard lock 1001 Front : Plastic black	IP 65	Aluminium natural	LL	1 NC + 1 NO	M	UT	A	14-438.036K	2	5	21	48	0.030
							2 NO	14-437.036K	2	5	21	49	0.030
			SA	1 NC + 1 NO	M	S	A	14-141.025K2		5	21	44	0.029
							S1	14-141.022K		5	21	44	0.029
				2 NC + 2 NO	M	S	A	14-142.025K2		5	21	45	0.031
							3 NC + 3 NO	M	S	A	14-143.025K2		5
4 NC + 4 NO	M	S	A	14-144.025K2		5	21			47	0.035		

Keylock switches are supplied with 2 keys.

Other lock numbers on request

Switching system: LL = Low level switching element, SA = Snap-action switching element

Contacts: NC = Normally closed, NO = Normally open

Switching action: MA = Maintained action, M = Momentary action

Terminals: UT = Universal terminal, S = Soldering terminal, S1 = Soldering terminal (also pluggable 2.8 x 0.5 mm)

Component layout from page 36, Mounting dimensions from page 37, Technical drawing from page 38, Circuit drawing from page 48

Selector switch 2 positions

non-illuminative



	Front protection	Front ring	Lever	Switching system	Contacts	Switching action	Terminals	Ø 29 mm Typ-Nr.	Component layout	Mounting dimensions	Technical drawing	Circuit drawing	E-1
Selector switch 2 positions Position A : Basic position	IP 67	Aluminium natural	Plastic black long	LL	1 NC + 1 NO	MA	UT	14-572.0360	2	5	22	29	0.025
						M	UT	14-567.0360	2	5	22	22	0.025
					2 NC	MA	UT	14-571.0360	2	5	22	28	0.025
						M	UT	14-566.0360	2	5	22	21	0.025
					2 NO	MA	UT	14-570.0360	2	5	22	30	0.025
						M	UT	14-565.0360	2	5	22	23	0.025
				SA	1 NC + 1 NO	MA	S	14-556.02502		5	22	24	0.024
							S1	14-556.0220		5	22	24	0.024
						M	S	14-551.02502		5	22	17	0.024
							S1	14-551.0220		5	22	17	0.024
					2 NC + 2 NO	MA	S	14-557.02502		5	22	25	0.026
						M	S	14-552.02502		5	22	18	0.026
			3 NC + 3 NO	MA	S	14-558.02502		5	22	26	0.028		
				M	S	14-553.02502		5	22	19	0.028		
			4 NC + 4 NO	MA	S	14-559.02502		5	22	27	0.030		
				M	S	14-554.02502		5	22	20	0.030		
			Plastic black short	LL	1 NC + 1 NO	MA	UT	14-522.0360	2	5	23	29	0.025
						M	UT	14-517.0360	2	5	23	22	0.025
					2 NC	MA	UT	14-521.0360	2	5	23	28	0.025
						M	UT	14-516.0360	2	5	23	21	0.025
					2 NO	MA	UT	14-520.0360	2	5	23	30	0.025
						M	UT	14-515.0360	2	5	23	23	0.025
				SA	1 NC + 1 NO	MA	S	14-506.02502		5	23	24	0.024
							S1	14-506.0220		5	23	24	0.024
M	S	14-501.02502					5	23	17	0.024			
	S1	14-501.0220					5	23	17	0.024			
2 NC + 2 NO	MA	S			14-507.02502		5	23	25	0.026			
	M	S			14-502.02502		5	23	18	0.026			
3 NC + 3 NO	MA	S	14-508.02502		5	23	26	0.028					
	M	S	14-503.02502		5	23	19	0.028					
4 NC + 4 NO	MA	S	14-509.02502		5	23	27	0.030					
	M	S	14-504.02502		5	23	20	0.030					

Switching system: LL = Low level switching element, SA = Snap-action switching element

Contacts: NC = Normally closed, NO = Normally open

Switching action: MA = Maintained action, M = Momentary action





Terminals: UT = Universal terminal, S = Soldering terminal, S1 = Soldering terminal (also pluggable 2.8 x 0.5 mm)

Component layout from page 36, Mounting dimensions from page 37, Technical drawing from page 38, Circuit drawing from page 48

Indicator actuator, flush mounting



Essential Accessories:

-  Front bezel set, flush mounting page 20
-  Lens plastic page 17
-  Marking plate for Lens plastic and metal page 18
-  Single-LED page 24

	Front protection	Terminals	Ø 35 mm Typ-Nr.	Component layout	Mounting dimensions	Technical drawing	Circuit drawing	
Indicator actuator, flush mounting	IP 67	S	14-040.005		1	24	3	0.050
		S1	14-040.002		1	24	3	0.050
		UT	14-041.006	2	1	24	2	0.050

Terminals: S = Soldering terminal, S1 = Soldering terminal (also pluggable 2.8 x 0.5 mm), UT = Universal terminal

Component layout from page 36, Mounting dimensions from page 37, Technical drawing from page 38, Circuit drawing from page 48

Buzzer, flush mounting



	Front protection	Front cap	Terminals	Ø 35 mm Typ-Nr.	Mounting dimensions	Technical drawing	Circuit drawing	
Buzzer, flush mounting Operation voltage : 24 VDC	IP 40	Aluminium black	S1	14-810.910	1	16	1	0.016
		Aluminium natural	S1	14-810.918	1	16	1	0.016

Further information in the Technical Data and Typical Applications





Terminals: S1 = Soldering terminal (also pluggable 2.8 x 0.5 mm)

Mounting dimensions from page 37, Technical drawing from page 38, Circuit drawing from page 48

Illuminated pushbutton actuator, flush mounting



Essential Accessories:

-  Front bezel set, flush mounting page 20
-  Lens plastic page 17
-  Marking plate for Lens plastic and metal page 18
-  Single-LED page 24

	Front protection	Switching system	Contacts	Diode (1N 4007)	Switching action	Terminals	Ø 35 mm Typ-Nr.	Component layout	Mounting dimensions	Technical drawing	Circuit drawing		
Illuminated pushbutton actuator, flush mounting	IP 67	LL	1 NC	-	MA	UT	14-476.036	2	1	25	12	0.015	
					M	UT	14-436.036	2	1	25	39	0.015	
			1 NC + 1 NO	-	MA	UT	14-473.036	2	1	25	15	0.015	
					M	UT	14-433.036	2	1	25	42	0.015	
			1 NO	-	MA	UT	14-475.036	2	1	25	14	0.015	
					M	UT	14-435.036	2	1	25	41	0.015	
			2 NC	-	MA	UT	14-472.036	2	1	25	13	0.015	
					M	UT	14-432.036	2	1	25	40	0.015	
			2 NO	-	MA	UT	14-471.036	2	1	25	16	0.015	
					M	UT	14-431.036	2	1	25	43	0.015	
			SA	1 NC + 1 NO	1 D	MA	UT	14-747.0292	2	1	25	9	0.014
						M	UT	14-743.0292	2	1	25	36	0.014
					2 D	MA	UT	14-748.0292	2	1	25	10	0.014
						M	UT	14-744.0292	2	1	25	37	0.014
					-	MA	S	14-271.0252		1	25	11	0.013
							S1	14-271.022		1	25	11	0.013
		M				S	14-131.0252		1	25	38	0.013	
						S1	14-131.022		1	25	38	0.013	
		2 NC + 2 NO			1 D	MA	UT	14-749.0292	2	1	25	6	0.016
						M	UT	14-745.0292	2	1	25	33	0.016
			2 D	MA	UT	14-750.0292	2	1	25	7	0.016		
				M	UT	14-746.0292	2	1	25	34	0.016		
			-	MA	S	14-272.0252		1	25	8	0.015		
				M	S	14-132.0252		1	25	35	0.015		
		3 NC + 3 NO	-	MA	S	14-273.0252		1	25	5	0.017		
				M	S	14-133.0252		1	25	32	0.017		
		4 NC + 4 NO	-	MA	S	14-274.0252		1	25	4	0.019		
				M	S	14-134.0252		1	25	31	0.019		

Switching system: LL = Low level switching element, SA = Snap-action switching element

Contacts: NC = Normally closed, NO = Normally open

Diode (1N 4007): - = without, D = Diode

Switching action: MA = Maintained action, M = Momentary action



Terminals: UT = Universal terminal, S = Soldering terminal, S1 = Soldering terminal (also pluggable 2.8 x 0.5 mm)

Component layout from page 36, Mounting dimensions from page 37, Technical drawing from page 38, Circuit drawing from page 48

Keylock switch actuator 2 positions, flush mounting



Essential Accessories:

-  Anti-twist ring, flush mounting page 25
-  Front bezel set, flush mounting page 20

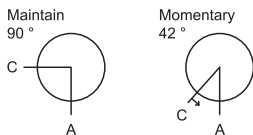

	Front protection	Switching system	Contacts	Switching action	Terminals	Key remove	Ø 35 mm Typ-Nr.	Component layout	Mounting dimensions	Technical drawing	Circuit drawing				
Keylock switch actuator 2 positions, flush mounting Position A : Basic position Position C : Maintained action Standard lock 1001, Front : Plastic black	IP 65	LL	1 NC + 1 NO	MA	UT	A	14-415.036K	2	1	26	54	0.030			
						C	14-418.036K	2	1	26	54	0.030			
						C + A	14-412.036K	2	1	26	54	0.030			
			2 NO	MA	UT	A	14-414.036K	2	1	26	55	0.030			
						C	14-417.036K	2	1	26	55	0.030			
						C + A	14-411.036K	2	1	26	55	0.030			
		SA	1 NC + 1 NO	MA	S	A	14-235.025K2		1	26	50	0.029			
						C	14-335.025K2		1	26	50	0.029			
						C + A	14-135.025K2		1	26	50	0.029			
						S1	A	14-235.022K		1	26	50	0.029		
							C	14-335.022K		1	26	50	0.029		
							C + A	14-135.022K		1	26	50	0.029		
			2 NC + 2 NO	MA	S	A	14-236.025K2		1	26	51	0.031			
						C	14-336.025K2		1	26	51	0.031			
						C + A	14-136.025K2		1	26	51	0.031			
			3 NC + 3 NO	MA	S	A	14-237.025K2		1	26	52	0.033			
						C	14-337.025K2		1	26	52	0.033			
						C + A	14-137.025K2		1	26	52	0.033			
4 NC + 4 NO	MA	S	A	14-238.025K2		1	26	53	0.035						
			C	14-338.025K2		1	26	53	0.035						
			C + A	14-138.025K2		1	26	53	0.035						
Position A : Basic position Position C : Momentary action Standard lock 1001 Front : Plastic black	IP 65	LL	1 NC + 1 NO	M	UT	A	14-438.036K	2	1	26	48	0.030			
						2 NO	14-437.036K	2	1	26	49	0.030			
		SA	1 NC + 1 NO	M	S	A	14-141.025K2		1	26	44	0.029			
						S1	14-141.022K		1	26	44	0.029			
			2 NC + 2 NO	M	S	A	14-142.025K2		1	26	45	0.031			
						3 NC + 3 NO	M	S	A	14-143.025K2		1	26	46	0.033
									4 NC + 4 NO	M	S	A	14-144.025K2		1

Keylock switches are supplied with 2 keys.

Other lock numbers on request

Switching system: LL = Low level switching element, SA = Snap-action switching element

Contacts: NC = Normally closed, NO = Normally open

Switching action: MA = Maintained action, M = Momentary action

Terminals: UT = Universal terminal, S = Soldering terminal, S1 = Soldering terminal (also pluggable 2.8 x 0.5 mm)

Component layout from page 36, Mounting dimensions from page 37, Technical drawing from page 38, Circuit drawing from page 48

Selector switch actuator 2 positions, flush mounting



Essential Accessories:

- Anti-twist ring, flush mounting page 25
- Front bezel set, flush mounting page 20

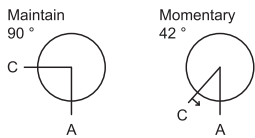

	Front protection	Lever	Switching system	Contacts	Switching action		Terminals	Ø 35 mm Typ-Nr.	Component layout			
					MA	UT			Mounting dimensions	Technical drawing	Circuit drawing	
Selector switch actuator 2 positions, flush mounting Position A : Basic position	IP 67	Plastic black short	LL	1 NC + 1 NO	MA	UT	14-522.0360	2	1	27	29	0.025
					M	UT	14-517.0360	2	1	27	22	0.025
				2 NC	MA	UT	14-521.0360	2	1	27	28	0.025
					M	UT	14-516.0360	2	1	27	21	0.025
				2 NO	MA	UT	14-520.0360	2	1	27	30	0.025
					M	UT	14-515.0360	2	1	27	23	0.025
			SA	1 NC + 1 NO	MA	S	14-506.02502		1	27	24	0.024
					S1	14-506.0220		1	27	24	0.024	
					M	S	14-501.02502		1	27	17	0.024
					S1	14-501.0220		1	27	17	0.024	
				2 NC + 2 NO	MA	S	14-507.02502		1	27	25	0.026
					M	S	14-502.02502		1	27	18	0.026
				3 NC + 3 NO	MA	S	14-508.02502		1	27	26	0.028
					M	S	14-503.02502		1	27	19	0.028
4 NC + 4 NO	MA	S	14-509.02502		1	27	27	0.030				
	M	S	14-504.02502		1	27	20	0.030				

Switching system: LL = Low level switching element, SA = Snap-action switching element

Contacts: NC = Normally closed, NO = Normally open

Switching action: MA = Maintained action, M = Momentary action

Terminals: UT = Universal terminal, S = Soldering terminal, S1 = Soldering terminal (also pluggable 2.8 x 0.5 mm)

Component layout from page 36, Mounting dimensions from page 37, Technical drawing from page 38, Circuit drawing from page 48

Front

Lens plastic

To obtain IP 67 use Marking plate Typ-Nr. 704.609.X

	Lens	Ø 29 mm Typ-Nr.	
Lens plastic	black opaque flush	704.602.0	0.001
	blue transparent flush	704.602.6	0.001
	colourless transparent flush	704.602.7	0.001
	green transparent flush	704.602.5	0.001
	red transparent flush	704.602.2	0.001
	yellow transparent flush	704.602.4	0.001



Lens raised, plastic

To obtain IP 67 use Marking plate Typ-Nr. 704.610.X

	Lens	Ø 29 mm Typ-Nr.	
Lens raised, plastic	colourless transparent flush	704.611.7	0.002
	green transparent flush	704.611.5	0.002
	red transparent flush	704.611.2	0.002
	yellow transparent flush	704.611.4	0.002



Lens metal with spot

To obtain IP 67 use Marking plate Typ-Nr. 704.609.X

	Lens	Ø 29 mm Typ-Nr.	
Lens metal with spot	Aluminium black flush	704.601.01	0.001
	Aluminium blue flush	704.601.61	0.001
	Aluminium gold flush	704.601.41	0.001
	Aluminium natural flush	704.601.81	0.001
	Aluminium olive-green flush	704.601.51	0.001
	Aluminium red flush	704.601.21	0.001
	Stainless steel natural flush	704.601.91	0.001



Lens metal

To obtain IP 67 use Marking plate Typ-Nr. 704.609.9

	Lens	Ø 29 mm Typ-Nr.	
Lens metal	Aluminium black flush	704.601.0	0.001
	Aluminium blue flush	704.601.6	0.001
	Aluminium gold flush	704.601.4	0.001
	Aluminium natural flush	704.601.8	0.001
	Aluminium olive-green flush	704.601.5	0.001
	Aluminium red flush	704.601.2	0.001
	Stainless steel natural flush	704.601.9	0.001



Lens cap

To obtain IP 67 use Marking plate Typ-Nr. 704.608.X

	Lens	Ø 29 mm Typ-Nr.	
Lens cap	Plastic blue transparent	704.603.6	0.003
	Plastic colourless transparent	704.603.7	0.003
	Plastic green transparent	704.603.5	0.003
	Plastic red transparent	704.603.2	0.003
	Plastic yellow transparent	704.603.4	0.003



Mushroom-head cap

To obtain IP 67 use Marking plate Typ-Nr. 704.609.9

	Mushroom had cap	Ø 40 mm Typ-Nr.	
Mushroom-head cap	Plastic black opaque	704.604.0	0.001
	Plastic green opaque	704.604.5	0.001
	Plastic red opaque	704.604.2	0.001
	Plastic yellow opaque	704.604.4	0.001



Mushroom-head cap illuminated

To obtain IP 67 use Marking plate Typ-Nr. 704.609.9

	Mushroom had cap	Ø 40 mm Typ-Nr.	
Mushroom-head cap illuminated	Plastic blue transparent	704.614.6	0.007
	Plastic colourless transparent	704.614.7	0.007
	Plastic green transparent	704.614.5	0.007
	Plastic red transparent	704.614.2	0.007
	Plastic yellow transparent	704.614.4	0.007



Marking plate for Lens plastic and metal

	Marking plate	Typ-Nr.	
Marking plate for Lens plastic and metal LED	Plastic colourless transparent ribbed	704.609.7	0.001
	Plastic white translucent	704.609.9	0.001
LED and Filament lamp non-illuminative	Plastic black opaque	704.609.0	0.001



Marking plate for Mushroom-head cap

	Marking plate	Typ-Nr.	
Marking plate for Mushroom-head cap	Plastic white translucent	704.609.9	0.001



Marking cap for Lens raised, plastic

	Marking cap	Typ-Nr.	
Marking cap for Lens raised, plastic LED	Plastic colourless transparent ribbed	704.610.7	0.001
LED and Filament lamp	Plastic white translucent	704.610.9	0.001



Marking cap for Lens cap

	Marking cap	Typ-Nr.	
Marking cap for Lens cap LED	Plastic colourless transparent ribbed	704.608.7	0.002
LED and Filament lamp	Plastic white translucent	704.608.9	0.002



Front ring

	Ø 29 mm Typ-Nr.	
Front ring	704.600.0	0.003
	704.600.6	0.003
	704.600.1	0.005
	704.600.1A	0.005
	704.600.9	0.006



Front bezel set for Mushroom-head pushbutton

	Front Bezel	Ø 50 mm Typ-Nr.	Mounting dimensions	Technical drawing	
Front bezel set for Mushroom-head pushbutton	Aluminium black	14-958.0	4	28	0.042
	Aluminium natural	14-958.8	4	28	0.042



Mounting dimensions from page 37, Technical drawing from page 38

Front bezel set, flush mounting

	Front bezel	Ø 35 mm Typ-Nr.	Mounting dimensions	
Front bezel set, flush mounting	Aluminium black	704.955.0	1	0.015
	Aluminium natural	704.955.1	1	0.015
	Stainless steel natural	704.955.9	1	0.033



Mounting dimensions from page 37

Legend frame

adhesive, Aluminium black

	Typ-Nr.	Technical drawing		
Legend frame 30 x 50 mm for raised mounting	704.968.2	9	0.001	
35 x 57.5 mm for flush mounting	704.968.3	10	0.001	



Technical drawing from page 38

Legend plate insert

for Legend frame 704.968.2 and 704.968.3

	Typ-Nr.		
Legend plate insert 14.5 x 23.5 mm, adhesive, Aluminium black	704.968.1	0.001	
14.5 x 23.5 mm, adhesive, Aluminium natural	704.968.0	0.001	



Protective cover, raised mounting

Mounting hole size 22.5 mm dia.

	Typ-Nr.	Technical drawing		
Protective cover, raised mounting hinged, transparent, with means for sealing, for Pushbutton	704.925.0	4	0.007	
hinged, transparent, with means for sealing, for Selector switch	704.925.2	6	0.007	
hinged, transparent, with means for sealing, with spring fitted, for Pushbutton	704.925.3	4	0.007	



Protection cover 704.925.2 only for selector switches in basic position A applicable.

Technical drawing from page 38

Protective cover, flush mounting

Mounting hole size 30.5 mm dia.

	Typ-Nr.	Technical drawing	
Protective cover, flush mounting hinged, Aluminium natural, with means for sealing, for Pushbutton and Selector switch short lever	704.928.38	8	0.019
hinged, Aluminium natural, with means for sealing, spring fitted, for Pushbutton and Selector switch short lever	704.928.28	5	0.019
hinged, Aluminium natural, with window, spring fitted, for Pushbutton	704.928.18	7	0.019



Technical drawing from page 38

Front protective cap

for Indicator and Illuminated pushbutton for protection IP 68

	Front protective cap	Typ-Nr.	
Front protective cap only together with Lenses 704.602.X, 704.601.X and Front rings 704.600.X	Silicone colourless transparent	704.953.0	0.002



Front protective ring

for Illuminated pushbutton with front illumination (IP 67)

	Front protective ring	Ø 29 mm Typ-Nr.	
Front protective ring with transparent Pebax membrane, temperature resistance -40 °C ... +85 °C	Aluminium natural	704.600.5/A	0.005
with transparent silicone membrane (extent resistant to sea water), temperature resistance -40 °C ... +85 °C	Aluminium natural	704.600.3	0.005
	Chromed brass	704.600.2	0.005



Front protective ring to be mounted with a torque of 40 Ncm onto actuator.

Front bezel with protective membrane, flush mounting

for Illuminated pushbutton (IP 67)

	Front bezel	Ø 35 mm Typ-Nr.	
Front bezel with protective membrane, flush mounting with transparent silicone membrane	Aluminium black	704.955.4	0.015
	Aluminium natural	704.955.3	0.015
with transparent silicone membrane, resistant to sea water	Stainless steel natural	704.955.9E	0.033



Front bezel to be mounted with a torque of 40 Ncm onto actuator.

Blind plug

	Blind plug	Front protection	Typ-Nr.	Technical drawing	
Blind plug Size 28 mm dia., for mounting hole 22.5 mm dia.	Plastic black	IP 65	704.960.4	3	0.004
Size 36 mm dia., for mounting hole 30.5 mm dia.	Plastic black	IP 65	704.964.8	2	0.007



Technical drawing from page 38

Spare key

	Typ-Nr.	
Spare key Standard lock 1001 (KABA)	14-987.1001	0.006



Other lock numbers on request

Backside

PCB plug-in base

	Typ-Nr.	Component layout	
PCB plug-in base 16.4 mm dia. x 9.8 mm for Low level switching element, Pins axial	31-940	3	0.002
17.8 x 12.9 mm x 9.8 mm for Snap-action switching element 2.8 mm, Pins axial	31-942	4	0.002
17.9 x 17.9 x 8.4 mm for Low level switching element, Pins bent at right-angle	31-941	1	0.004



PCB plug-in base Pins right-angle : With the extendable mounting the distance between plug-in base and PCB can be varied up to 3 mm.

Component layout from page 36

Flat receptacle

	Typ-Nr.	
Flat receptacle 2.0 x 0.5 mm for Universal terminal	31-945	0.001
2.8 x 0.5 mm for Plug-in terminal	31-946	0.001



Insulation sleeve

	Typ-Nr.	
Insulation sleeve Cover Plug-in terminals for snap-action switching element 2.8 mm	01-928	0.001
for Flat receptacle 31-945	31-928	0.001
for Flat receptacle 31-946	31-929	0.001



Terminal cover

	Typ-Nr.	
Terminal cover	01-929	0.010



Illumination

Filament lamp

	Socket	Operating voltage/-current	Typ-Nr.	
Filament lamp	T5.5	12 VAC/DC, 100 mA	10-1109.1329	0.001
		12 VAC/DC, 50 mA	10-1109.1279	0.001
		24 VAC/DC, 25 mA	10-1112.1199	0.001
		24 VAC/DC, 50 mA	10-1112.1279	0.001
		28 VAC/DC, 40 mA	10-1113.1249	0.001
		30 VAC/DC, 40 mA	10-1114.1249	0.001
		36 VAC/DC, 35 mA	10-1116.1229	0.001
		48 VAC/DC, 25 mA	10-1119.1199	0.001
		6 VAC/DC, 200 mA	10-1106.1369	0.001



Single-LED

Single-LED	Socket	Light colour	Operating voltage/-current	Typ-Nr.	 kg
Single-LED	T5.5	blue	12 VAC/DC, 7/14 mA	10-2109.1066	0.001
			24 VAC/DC, 7/14 mA	10-2112.1066	0.001
			28 VAC/DC, 7/14 mA	10-2113.1066	0.001
			48 VAC/DC, 4/8 mA	10-2119.1046	0.001
			6 VDC, 15 mA	10-2106.3146	0.001
		green	12 VAC/DC, 7/14 mA	10-2109.1065	0.001
			24 VAC/DC, 7/14 mA	10-2112.1065	0.001
			28 VAC/DC, 7/14 mA	10-2113.1065	0.001
			48 VAC/DC, 4/8 mA	10-2119.1045	0.001
			6 VDC, 15 mA	10-2106.3145	0.001
		red	12 VAC/DC, 7/14 mA	10-2109.1062	0.001
			24 VAC/DC, 7/14 mA	10-2112.1062	0.001
			28 VAC/DC, 7/14 mA	10-2113.1062	0.001
			48 VAC/DC, 4/8 mA	10-2119.1042	0.001
			6 VDC, 15 mA	10-2106.3142	0.001
		white diffuse	12 VAC/DC, 7/14 mA	10-2109.1069	0.001
			24 VAC/DC, 7/14 mA	10-2112.1069	0.001
			28 VAC/DC, 7/14 mA	10-2113.1069	0.001
			48 VAC/DC, 4/8 mA	10-2119.1049	0.001
			6 VDC, 15 mA	10-2106.3149	0.001
		yellow	12 VAC/DC, 7/14 mA	10-2109.1064	0.001
			24 VAC/DC, 7/14 mA	10-2112.1064	0.001
			28 VAC/DC, 7/14 mA	10-2113.1064	0.001
			48 VAC/DC, 4/8 mA	10-2119.1044	0.001
6 VDC, 15 mA	10-2106.3144		0.001		



Note:
AC operation through halve-wave rectifier possible, slight flickering can occur.

Terminal plate empty

for fitting with series resistors

	Typ-Nr.	 kg
Terminal plate empty 10 spaces 125 x 60 x 15 mm	02-912.2	0.045
15 spaces 187.5 x 60 x 15 mm	02-912.3	0.090
20 spaces 250 x 60 x 15 mm	02-912.4	0.095
5 spaces 62.5 x 60 x 15 mm	02-912.1	0.025



Assembling

Positioning insert

	Typ-Nr.	Mounting dimensions	
Positioning insert	14-910	3	0.001



Mounting dimensions from page 37

Anti-twist ring, flush mounting

	Typ-Nr.	
Anti-twist ring, flush mounting	704.954.0	0.002



Reducing ring

Devices 22.5 mm dia. in mounting hole size 30.5 mm dia.

	Typ-Nr.	
Reducing ring Aluminium black	704.960.0	0.004
Aluminium natural	704.960.8	0.004



You need to install two reduction rings.

Lens plug for round lens, flush mounting

	Typ-Nr.	
Lens plug for round lens, flush mounting for mounting and dismantling of Lens round, flush mounting	700.006.0	0.003



Lamp remover

	Typ-Nr.	
Lamp remover	02-906	0.002



CAUTION

A switching process might be released when replacing the Lamp/LED !

Enclosure

Grey similar RAL 7035; cover lead-sealable

	Dimension	Typ-Nr.	Technical drawing	
Enclosure with mounting hole 1 x 22.5 mm dia., with anti-twist device	L 94 mm, W 94 mm, H 81 mm	704.945.1	11	0.211
with mounting hole 2 x 22.5 mm dia., with anti-twist device	L 130 mm, W 94 mm, H 81 mm	704.945.2	12	0.251
with mounting hole 3 x 22.5 mm dia., with anti-twist device	L 180 mm, W 94 mm, H 81 mm	704.945.3	13	0.313
with mounting hole 4 x 22.5 mm dia., with anti-twist device	L 180 mm, W 182 mm, H 110 mm	704.945.4	14	0.572
with mounting hole 6 x 22.5 mm dia., with anti-twist device	L 180 mm, W 182 mm, H 110 mm	704.945.5	15	0.568



Openings for cable gland M16 or M20.

Protection class IP 66.

Technical drawing from page 38

Cable gland

	Typ-Nr.	kg
Cable gland M16, Plastic grey	61-9481.6	0.007
M20, Plastic grey	704.945.6	0.011



with traction relief; protection degree IP 68.

Actuator with snap-action switching element

Switching system

Self-cleaning, double-break, snap action switching system (with contact gap 2 x 0.5 mm).
 1 normally closed or 1 normally open contact per element.
 Snap-action switching elements with soldering terminals at the sides: up to 4 switching element can be on a pushbutton (max. 4 normally closed and 4 normally open contacts).
 Snap-action switching element with axial plug-in terminals 2.8 mm stackable, only 1 switching element can be on a pushbutton.

Material

Material of contact
 Gold plated silver

Switch housing
 Plug-in-/soldering terminal
 Diallylphthalate DAP, Polyamide 66, Polysulfone, heat-resistant and self-extinguishing
 Soldering terminal: PA 6.6 Ultramide

Actuator housing
 Polyamide

Mechanical characteristics

Terminals
 Snap-action switching element with tinned soldering terminals at the sides:
 Max. wire diameter 2 wires à 1.2 mm
 max. wire cross-section of stranded cable 1 x 1 mm²

Snap-action switching element with axial plug-in terminals, which can also be used as soldering terminals: Plug-in terminal 2.8 x 0.5 mm

Soldering terminal:
 Max. wire diameter 2 wires of 1 mm
 Max. wire cross-section of stranded cable 2 x 0.75 mm² or 1 x 1.0 mm²

Actuating torque
 Measured at the key or lever of the keylock- or selector switch
 2.5 Ncm ... 5.5 Ncm, depending on the number of switching elements

Actuating force
 Maintain 5 N ... 7.8 N
 Momentary 3.2 N ... 6 N
 depending on the number of switching elements

Actuating travel
 Illuminated pushbutton: 3 mm
 Switch actuator 2 positions:
 Momentary action 1 x ca. 42° deflection momentary action
 Maintained action 1 x ca. 90° deflection maintained action

Rebound time
 ≤5ms

Mechanical lifetime
 Momentary action 2 million Cycles of operation
 Maintained action 1 million Cycles of operation

Electrical characteristics

Standards
 The devices comply with : EN IEC 61058-1

Rated voltage
 250 VAC/DC as per EN IEC 61058-1-15

Contact resistance
 New state ≤50 mΩ as per DIN IEC 60512-2-4

Electrostatic discharge (ESD)
 Keylock switch 15 kV

Rated current
 5 A

Conventional free air thermal current I_{th}
 5 A
 The maximum current in continuous operation and at ambient temperature not exceeding the quoted maximum values.

Switch rating
 250 VAC, 5 A (cosφ 1)
 250 VAC, 3 A (cosφ 0,3)

Switch rating AC (cosφ 0,7)

Voltage	125 VAC	250 VAC
Current	3 A	2 A

Switch rating DC (inductive) L:R = 30 ms

Voltage	24 VDC	60 VDC	110 VDC	220 VDC
Current	2 A	0.7 A	0.2 A	0.1 A

Electric strength
 3000 VAC, 50 Hz, 1 min. between all terminals and earth, as per EN IEC 61058-1-15

Isolation resistance
 >7 MΩ between the open contacts at 500 VDC, as per EN IEC 61058-1-15 (reinforced insulation)

Protection class
 II

Environmental conditions

Storage temperature
 -40 °C ... +85 °C

Service temperature
 -25 °C ... +55 °C
 For indicators and illuminated pushbuttons mounted as a block, make sure the heat can escape freely.

Protection degree
 as per EN IEC 60529
 front side IP 67

Shock resistance
 (semi-sinusoidal)
 max. 150 m/s², pulse width 11 ms, 3-axis, as per EN IEC 60068-2-27

Vibration resistance
 (sinusoidal)
 max. 100 m/s² at 10 Hz ... 500 Hz, as per EN IEC 60068-2-6

Climate resistance

Damp heat state as per EN IEC 60068-2-30
Damp heat cyclic as per EN IEC 60068-2-78

Approvals

Approbations

CB (IEC 61058)
CSA
ENEC (EN 61058)
Germanischer Lloyd
UL

Declaration of conformity

CE

Rebound time

typical <100 μ s

Mechanical lifetime

Momentary action 5 million cycles of operation
Maintained action 1 million cycles of operation

Electrical characteristics

Contact resistance

New state ≤ 50 m Ω as per DIN IEC 60512-2-4

Electrostatic discharge (ESD)

Keylock switch 15 kV

Switch rating

10 μ A, 100 μ V to 100 mA at 42 VAC/VDC

Electric strength

3000 VAC, 50 Hz, 1 min. between all terminals and earth, as per EN IEC 61058-1-15

Protection class

II

Environmental conditions

Storage temperature

-40 °C ... +85 °C

Service temperature

-25 °C ... +55 °C

For indicators and illuminated pushbuttons mounted as a block, make sure the heat can escape freely.

Protection degree

as per EN IEC 60529
front side IP 67

Shock resistance

(semi-sinusoidal)
max. 150 m/s², pulse width 11 ms, 3-axis, as per EN IEC 60068-2-27

Actuator with low level switching element

Switching system

This low level switching element was designed for switching low powers in electronic circuits. The mechanism assures reliable switching of loads ranging from a few μ A/ μ V up to 100 mA/42 VAC/DC.

Single-break momentary contact, as normally open or normally closed with 4 independent points of contact. 2 momentary contacts per switching element; combination of normally open and normally closed is possible.

Special features are the long life, extremely short rebound time and stable contact resistance.

Material

Material of contact

Gold plated

Switch housing

Polysulfone, heat-resistant and self-extinguishing

Actuator housing

Polyamide

Mechanical characteristics

Terminals

The universal terminals permit these units to be mounted on printed circuit boards (PCB). These terminals can also be used as soldering or plug-in terminals.

For these terminals we can also supply a plug-in base which, when soldered on to the board, enables the switch to be plugged in.

Soldering terminal:

Max. wire diameter 2 wires of 1 mm

Max. wire cross-section of stranded cable 2 x 0.75 mm²

Plug-in terminal: 2.0 x 0.5 mm.

Actuating torque

Measured at the key or lever of the keylock- or selector switch
2.5 Ncm ... 5.5 Ncm, depending on the number of switching elements

Actuating force

3 ... 4 N, depending on the number of switching elements

Actuating travel

Illuminated pushbutton : 3 mm

Switch actuator 2 positions:

Momentary action 1 x ca. 42° deflection momentary action

Maintained action 1 x ca. 90° deflection maintained action

Buzzer

Buzzer system

System

Piezo disc

Material

Alarm buzzer case

Polyamide

Front cap

Plastic Polyamide

Metal Nickel-plated brass (sea-water proof)

Mechanical characteristics

Terminals

Plug-in terminal 2.8 x 0.5 mm

Electrical characteristics

Frequency (tone)

approx. 2.8 kHz continuous tone only

Sound pressure

95 db (A) ± 8 dB at a distance of 0.1 m

Operation Voltage/Current

Operation Voltage 24 VDC ± 10 %

Operation Current ≤ 25 mA

Environmental conditions**Storage temperature**

-40 °C ... +85 °C

Operating temperature

-25 °C ... +55 °C

Protection degree

as per EN IEC 60529, frontside

IP 40, devices flush mounting

IP 65, devices raised mounting

Approvals**Declaration of conformity**

CE

Diode element

When indicators and illuminated pushbuttons equipped with diodes, the user is able to perform a lamp check or wire an alarm circuit simply with a considerable saving of space.

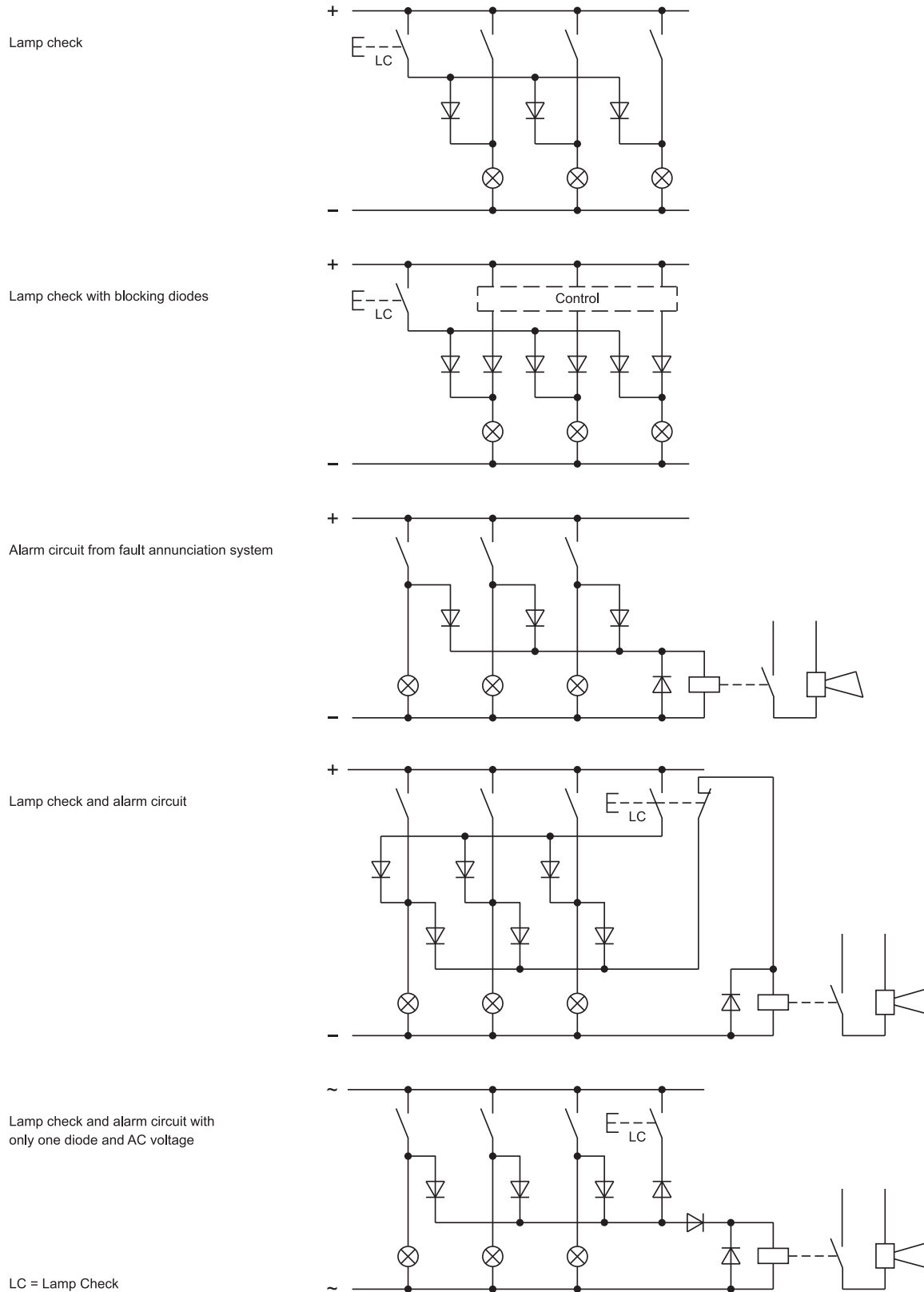

Suppressor circuits

When switching inductive loads such as relays, DC motors, and DC solenoids, it is always important to absorb surges (e.g. with a diode) to protect the contacts. When these inductive loads are switched off, a counter emf can severely damage switch contacts and greatly shorten lifetime.

Fig. 1 shows an inductive load with a free-wheeling diode connected in parallel. This free-wheeling diode provides a path for the inductor current to flow when the current is interrupted by the switch. Without this free-wheeling diode, the voltage across the coil will be limited only by dielectric breakdown voltages of the circuit or parasitic elements of the coil. This voltage can be kilovolts in amplitude even when nominal circuit voltages are low (e.g. 12 VDC) see Fig. 2.

The free-wheeling diode should be chosen so that the reverse breakdown voltage is greater than the voltage driving the inductive load. The DC blocking voltage (VR) of the free-wheeling diode can be found in the datasheet of a diode. The forward current should be equal or greater than the maximum current flowing through the load.

To get an efficient protection, the free-wheeling diode must be connected as close as possible to the inductive load!

Switching with inductive load
Fig. 1

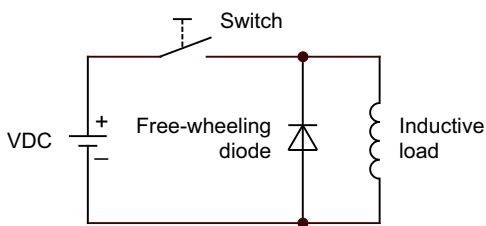

Counter emf
over load without free-wheeling diode
Fig. 2



General notes

1. Engraving

In addition to the most commonly used world languages, in DIN 1451-3 close spacing, other typefaces are available as Scandinavian, Slavic, Greek, Russian and Polish.

The lenses are filled with black or white colour. Standard height of letters is 3 mm. If the height is not specified, we will supply 3 mm engraved letters.

2. Hot stamping

Standard legends and ISO symbols are hot stamped. For larger series it is worth considering markings by means of hot stamping. We will be pleased to advise you.

Engraving marking cap for Indicator round, full face illumination

All dimensions in mm

Height of letters	Number of lines	Number of (target value) letters per line			Line spacing
		b1	b2	b3	
3	3	11	10	9	4.6
4	2	8	7	-	6.6
8	1	4	-	-	-

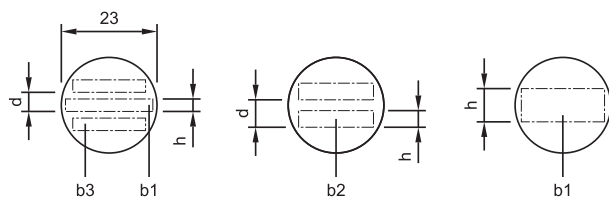

The gap between 2 words results in each case a letter less.

Engraving marking cap for Indicator and illuminated Pushbutton round, front illumination

All dimensions in mm

Height of letters	Number of lines	Number of (target value) letters per line			Line spacing
		b1	b2	b3	
3	3	9	9	7	4.6
4	2	7	6	-	6.6
8	1	3	-	-	-

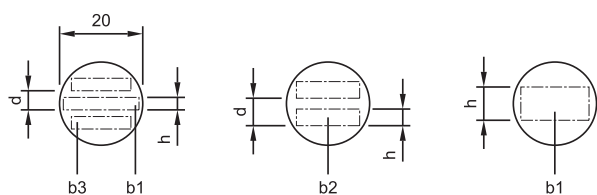

The gap between 2 words results in each case a letter less.

Engraving legend plates

All dimensions in mm

Dimension	Devices mounting style	Height of letters h	Number of lines	Number of (target value) letters per line	Image
30 x 50	round, raised	3	2	12	B1
		4	1	7	B1
		8	1	4	B1
35 x 57.5	round, flush	3	2	12	B2
		4	1	7	B2
		8	1	4	B2

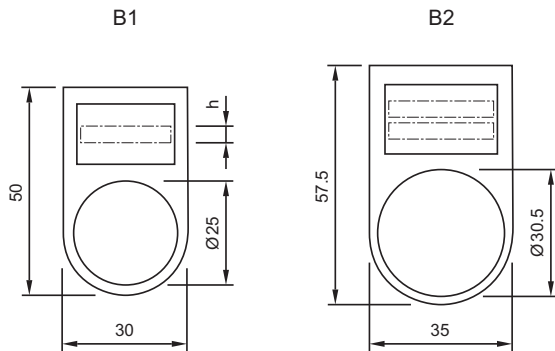







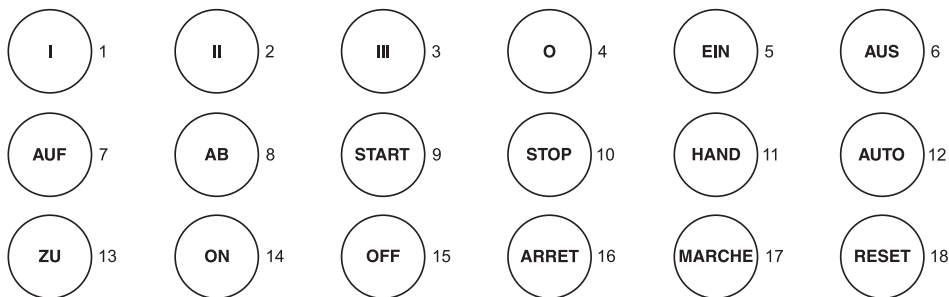





















































The gap between 2 words results in each case a letter less.

Standard texts for marking plates and marking caps for Indicator and Illuminated Pushbutton

Height of letters 6 mm



























Symbols for marking plates and marking caps for Indicator and Illuminated Pushbutton

	1 Direction of linear rectilinear motion (also for $\rightarrow \updownarrow$)		13 Direction of spindle rotation		29 Decrease of value (speed, for instance)		49 Cooling pump
	2 Linear motion in in 2 directions (also for \updownarrow)		14 One revolution		30 Speed of planing cut		50 Lubricant pump
	3 Interrupted linear motion (also for $\leftarrow \rightarrow \updownarrow$)		15 Number of revolutions per minute (spindle speed)		31 Speed of turning cut		51 Hydraulic system pump
	4 Limited linear motion (also for $\leftarrow \updownarrow$)		16 Feed		32 Speed of drilling cut		52 Hydraulic motor
	5 Limited linear motion and return		17 Feed per revolution		33 Speed of milling cut (similar symbol for speed of grinding)		53 Tracer
	6 Oscillating linear motion (continuous)		18 Feed per minute		34 Conventional milling		61 Stepless regulation
	7 Direction of continuous rotation (right)		19 Reduced feed		35 Climb milling (down milling)		62 Adjustable
	7a Direction of continuous rotation (left)		20 Rapid feed		41 Electric motor		63.1 Lock or tighten
	8 Rotation in 2 directions		21 Normal feed		42 Rectangular work table or slide element		63.2 Lock or tighten
	9 Direction of interrupted rotation (right)		22 Direction of feed (orientation not specified)		43 Round work table or rotating element		64.1 Unlock, unclamp
	9a Direction of interrupted rotation (left)		24 Transverse feed		44 Turning spindle		64.2 Chuck open
	10 Limited rotation (right)		25 Vertical feed		45 Drilling spindle		65 Brake on
	10a Limited rotation (left)		26 Rapid traverse		46 Milling spindle		66 Brake off
	11 Limited rotation and return		27 Threading		47 Grinding spindle		67 Automatic (or semi-automatic) cycle
	12 Oscillating rotary movement (continuous)		28 Increase of value (speed, for instance)		48 Pump (general symbol)		68 Hand control

Continuation see next page

Continued from previous page

 69 Start, on	 77 Open lock-nut	 93 Caution!	 106 Drain
 70 Stop, off	 78 Engage sensor	 94 Main switch	 107 Oil, lubricant
 71 Start and stop with same button	 79 Disengage sensor	 101 Coolant fluid	 108 Blast
 72 In action as long as button is operated	 80 Change speed only in stopped position	 102 Machine lighting	 109 Suction
 74 Engaging (mechanical start)	 81 Change speed only in motion	 103 Weight	
 75 Disengaging (mechanical stop)	 91 Shear pin construction	 104 Filter opening	
 76 Close lock-nut	 92 Danger (high voltage)	 105 Overflow	

Component layout

1 PCB plug-in base page 22

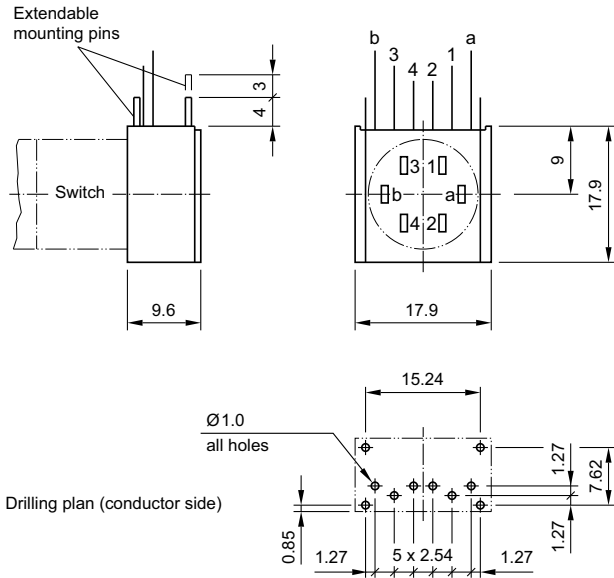

2 Indicator actuator full face illumination page 6 | Indicator actuator front illumination page 6 | Illuminated actuator pushbutton page 8 | Mushroom-head actuator pushbutton page 9 | Illuminated mushroom-head actuator pushbutton page 10 | Keylock switch 2 positions page 11 | Selector switch 2 positions page 12 | Indicator actuator, flush mounting page 13 | Illuminated pushbutton actuator, flush mounting page 14 | Keylock switch actuator 2 positions, flush mounting page 15 | Selector switch actuator 2 positions, flush mounting page 16

Terminals (rearside)

PCB layout (conductor side)

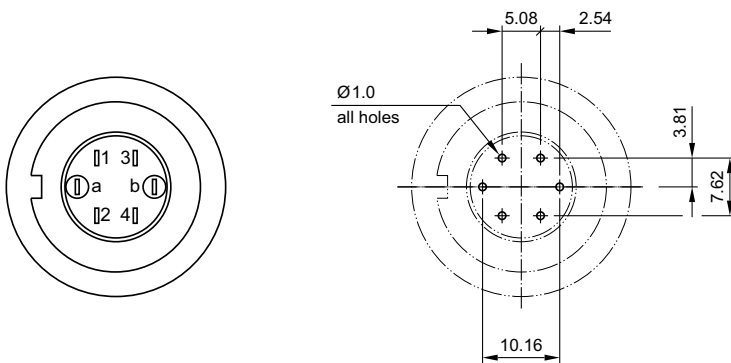

3 PCB plug-in base page 22

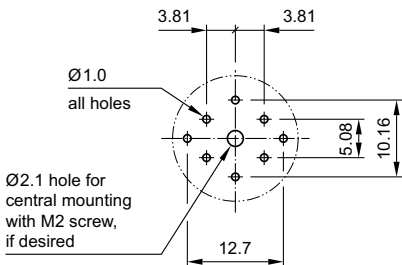

4 PCB plug-in base page 22

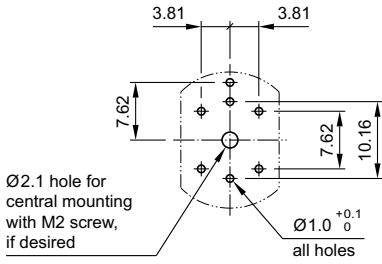

Mounting dimensions

1 Indicator actuator, flush mounting page 13 | Buzzer, flush mounting page 13 | Illuminated pushbutton actuator, flush mounting page 14 | Keylock switch actuator 2 positions, flush mounting page 15 | Selector switch actuator 2 positions, flush mounting page 16 | Front bezel set, flush mounting page 20

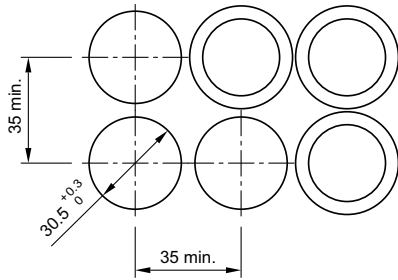

Hole spacing 37 mm min. by using blind plug 704.960.8

2 Mushroom-head actuator pushbutton page 9 | Illuminated mushroom-head actuator pushbutton page 10

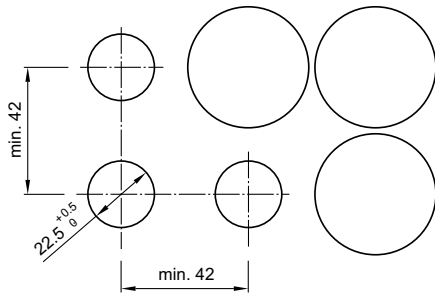

3 Positioning insert page 25

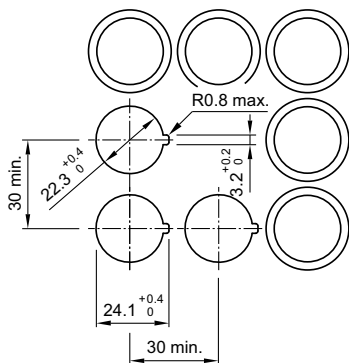

4 Front bezel set for Mushroom-head pushbutton page 19

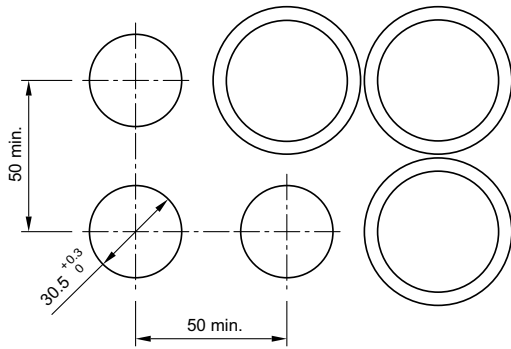

5 Indicator actuator full face illumination page 6 | Indicator actuator front illumination page 6 | Buzzer page 7 | Illuminated actuator pushbutton page 8 | Keylock switch 2 positions page 11 | Selector switch 2 positions page 12

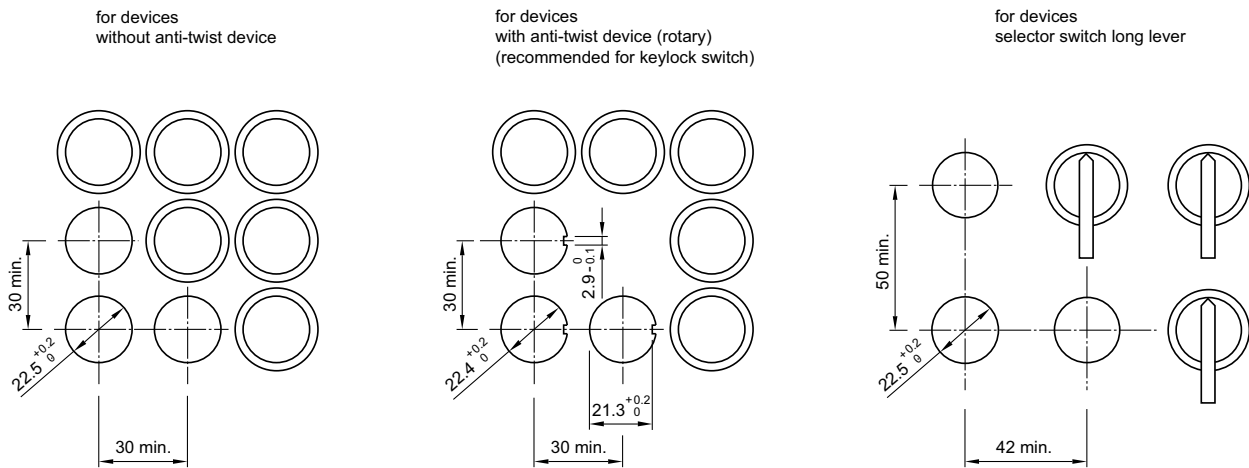

Hole spacing 31 mm min. by using blind plug 704.960.4

Technical drawing

1 Buzzer page 7

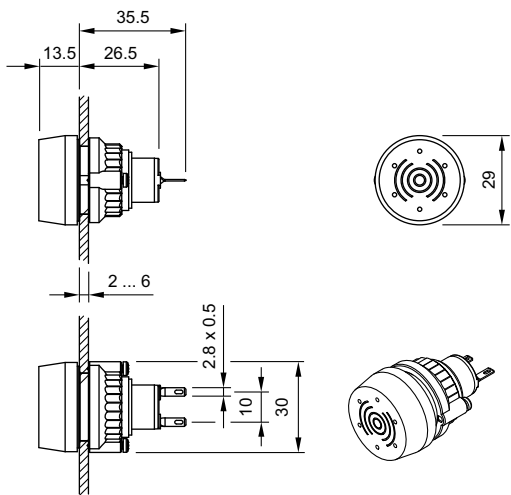

2 Blind plug page 22

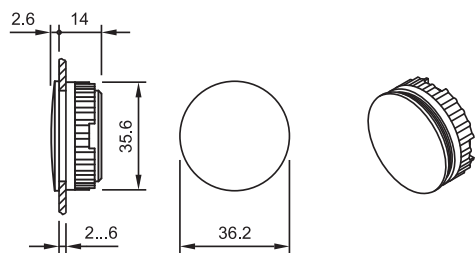

3 Blind plug page 22

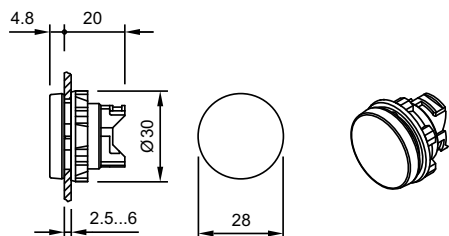

4 Protective cover, raised mounting page 20

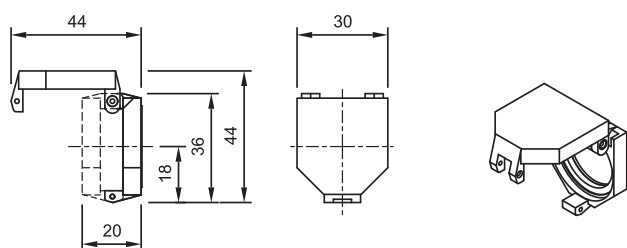

Front panel thickness reduces by 3.5 mm to max. 4.5 mm

5 Protective cover, flush mounting page 21

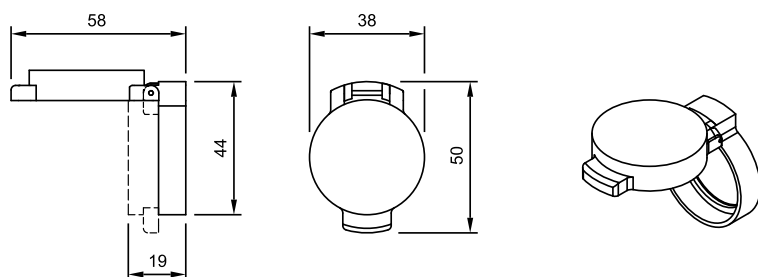

Front panel thickness reduces by 2.5 mm to max. 3.5 mm

6 Protective cover, raised mounting page 20

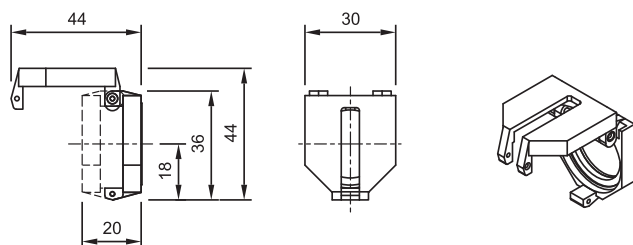

Front panel thickness reduces by 3.5 mm to max. 4.5 mm

7 Protective cover, flush mounting page 21

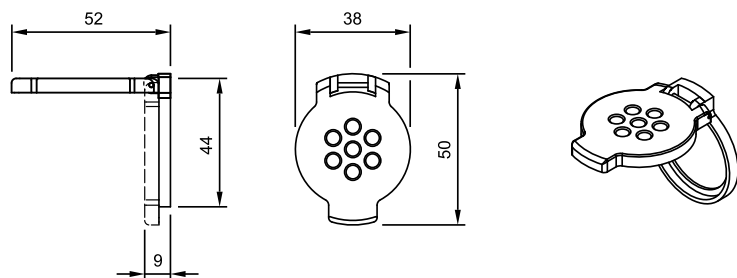

Front panel thickness reduces by 2.5 mm to max. 3.5 mm

8 Protective cover, flush mounting page 21

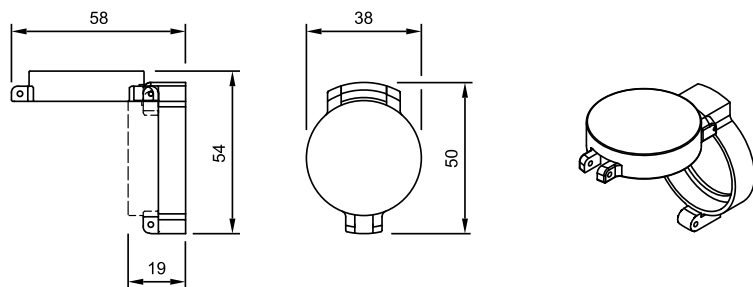

Front panel thickness reduces by 2.5 mm to max. 3.5 mm

9 Legend frame page 20

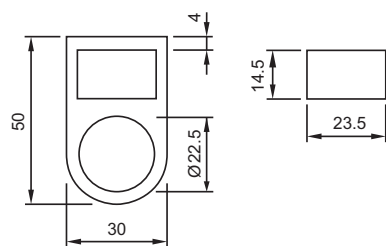

10 Legend frame page 20

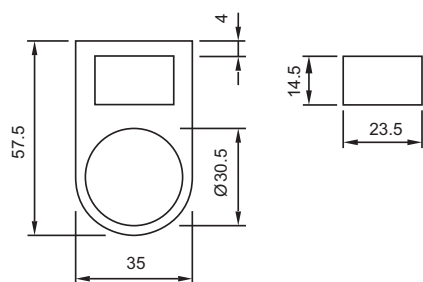

11 Enclosure page 26

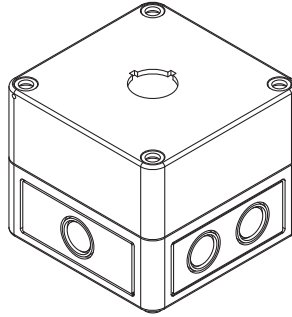
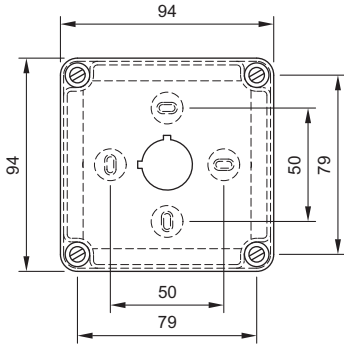
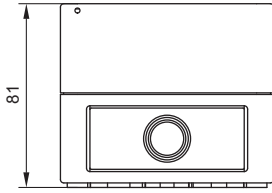

12 Enclosure page 26

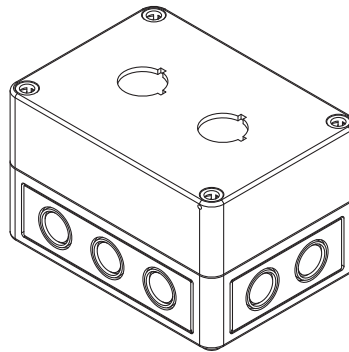
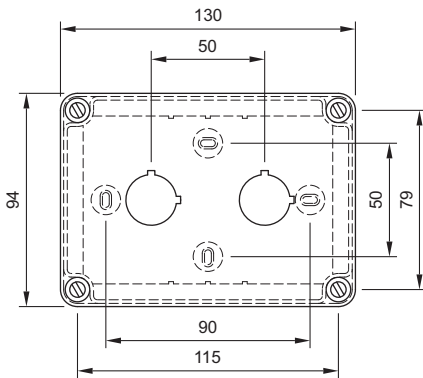
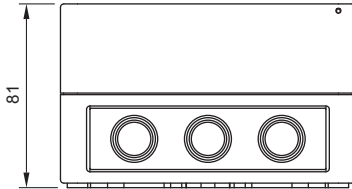

13 Enclosure page 26

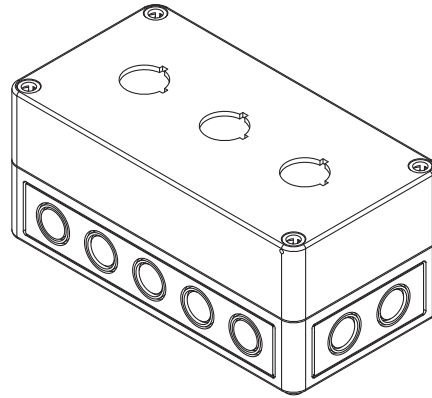
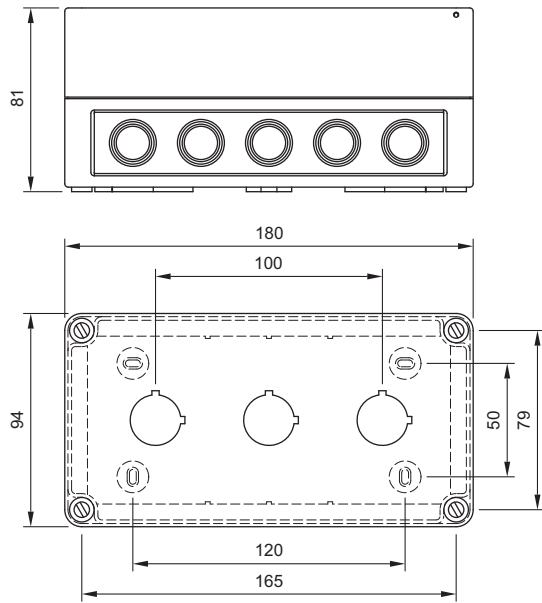

14 Enclosure page 26

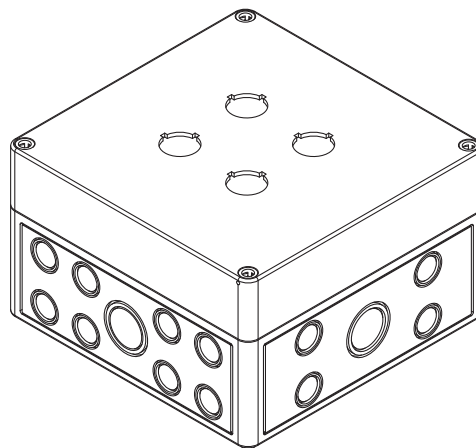
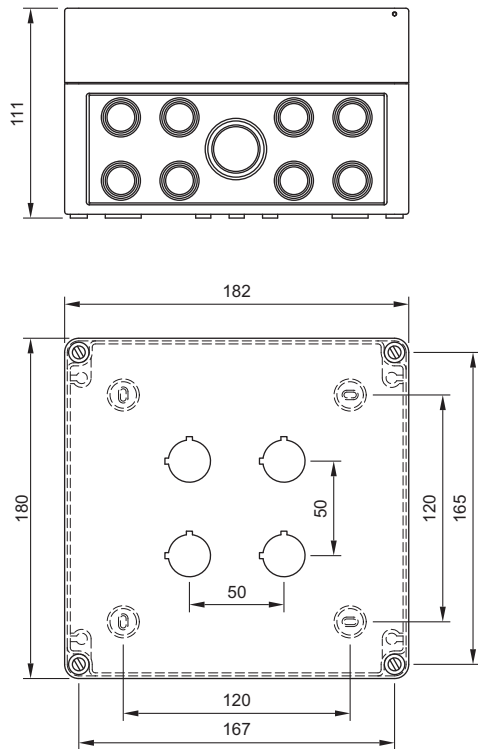

15 Enclosure page 26

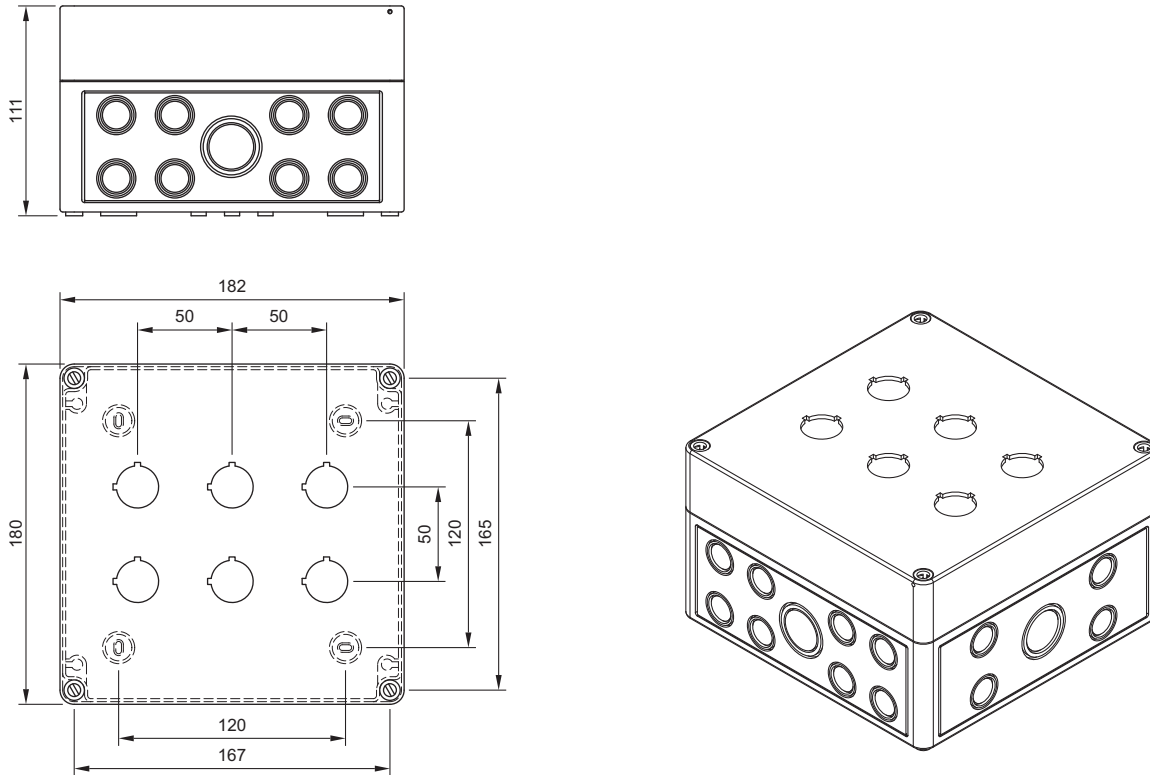

16 Buzzer, flush mounting page 13

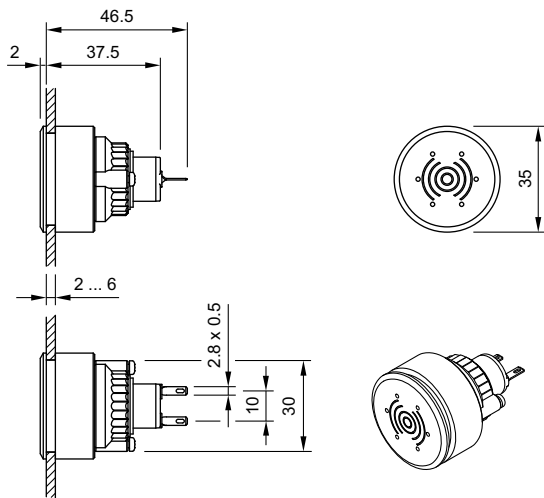

17 Indicator actuator full face illumination page 6

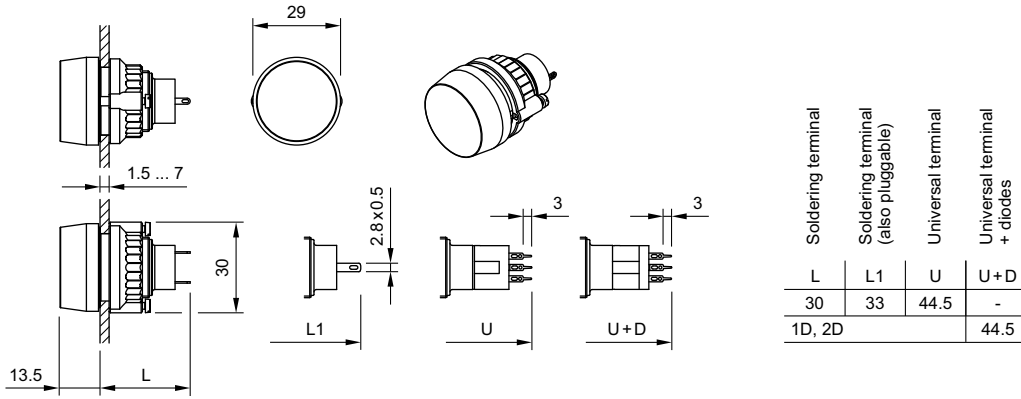

18 Mushroom-head actuator pushbutton page 9 | Illuminated mushroom-head actuator pushbutton page 10

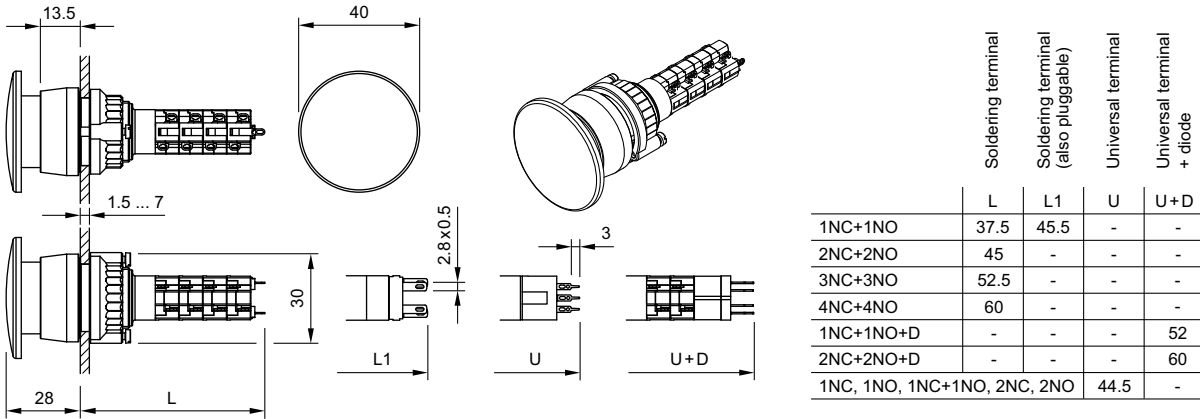

19 Indicator actuator front illumination page 6

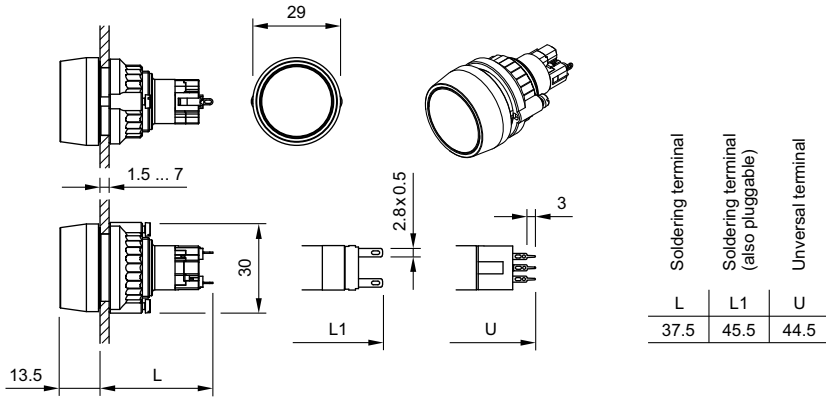

20 Illuminated actuator pushbutton page 8

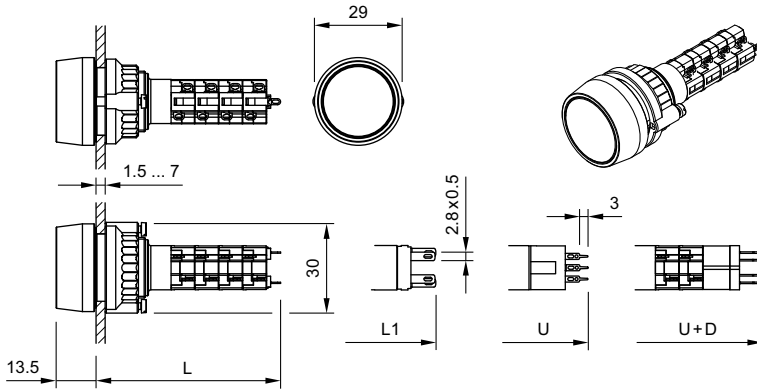

	Soldering terminal	Soldering terminal (also pluggable)	Universal terminal	Universal terminal + diode
	L	L1	U	U+D
1NC+1NO	37.5	45.5	-	-
2NC+2NO	45	-	-	-
3NC+3NO	52.5	-	-	-
4NC+4NO	60	-	-	-
1NC+1NO+D	-	-	-	52
2NC+2NO+D	-	-	-	60
1NC, 1NO, 1NC+1NO, 2NC, 2NO	44.5			-

21 Keylock switch 2 positions page 11

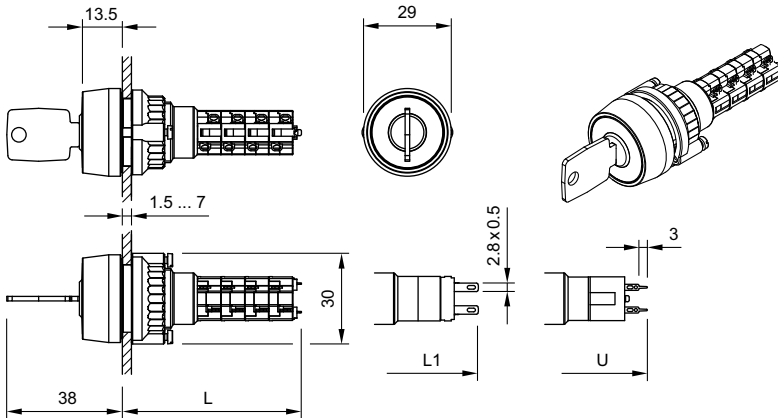

	Soldering terminal	Soldering terminal (also pluggable)	Universal terminal
	L	L1	U
1NC+1NO	35.5	45.5	-
2NC+2NO	43	-	-
3NC+3NO	50.5	-	-
4NC+4NO	58	-	-
1NC, 1NO, 1NC+1NO, 2NC, 2NO	44.5		

22 Selector switch 2 positions page 12

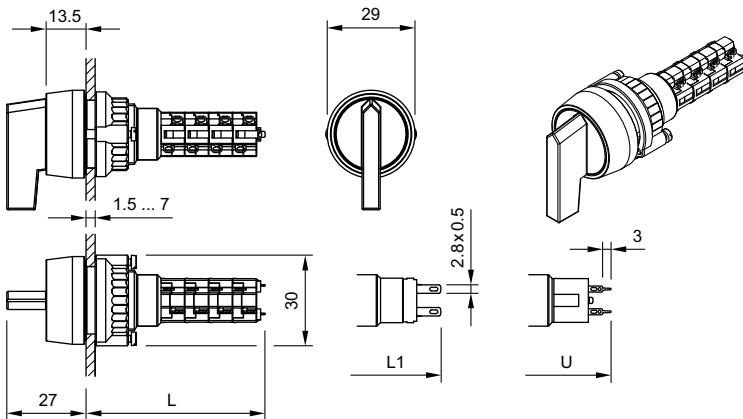

	Soldering terminal	Soldering terminal (also pluggable)	Universal terminal
	L	L1	U
1NC+1NO	35.5	45.5	-
2NC+2NO	43	-	-
3NC+3NO	50.5	-	-
4NC+4NO	58	-	-
1NC, 1NO, 1NC+1NO, 2NC, 2NO	44.5		

23 Selector switch 2 positions page 12

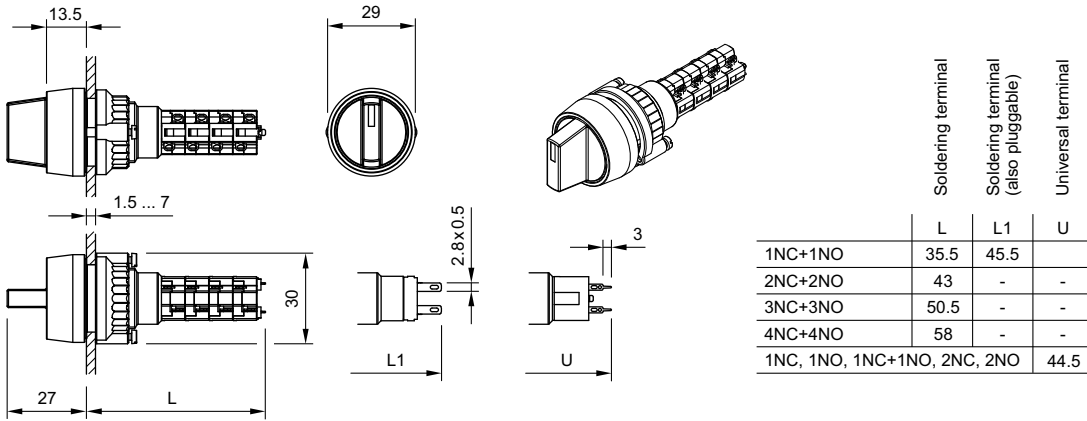

24 Indicator actuator, flush mounting page 13

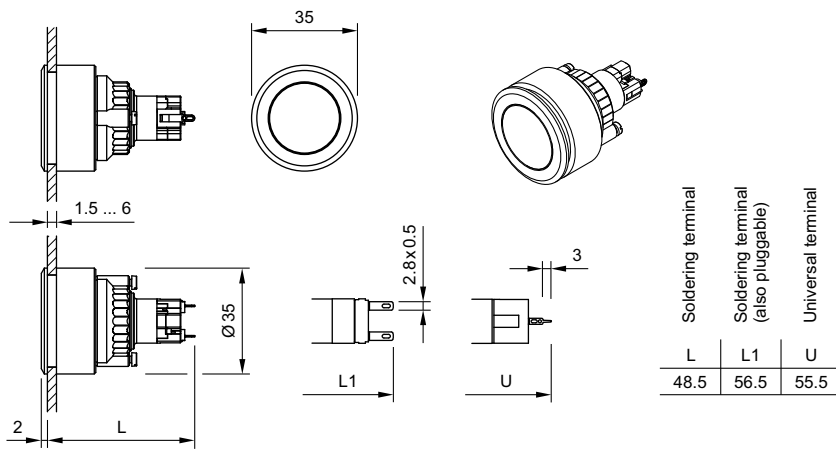

25 Illuminated pushbutton actuator, flush mounting page 14

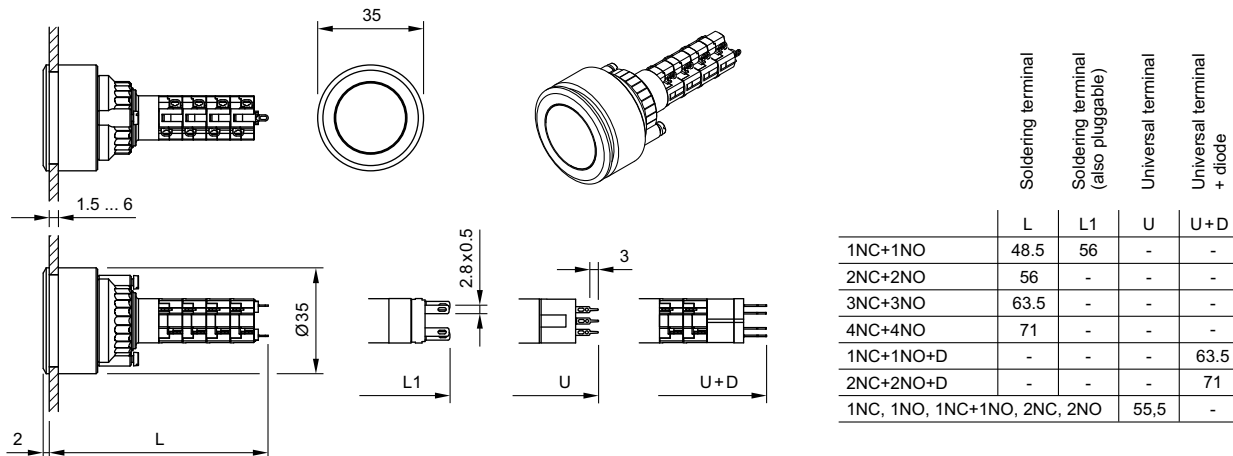

26 Keylock switch actuator 2 positions, flush mounting page 15

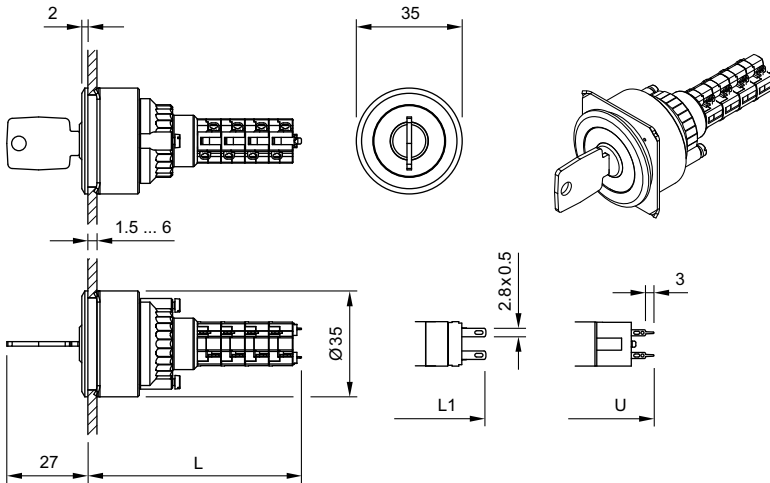

	Soldering terminal	Soldering terminal (also pluggable)	Universal terminal
	L	L1	U
1NC+1NO	46.5	56	-
2NC+2NO	54	-	-
3NC+3NO	61.5	-	-
4NC+4NO	69	-	-
1NC+1NO, 2NO			55.5

27 Selector switch actuator 2 positions, flush mounting page 16

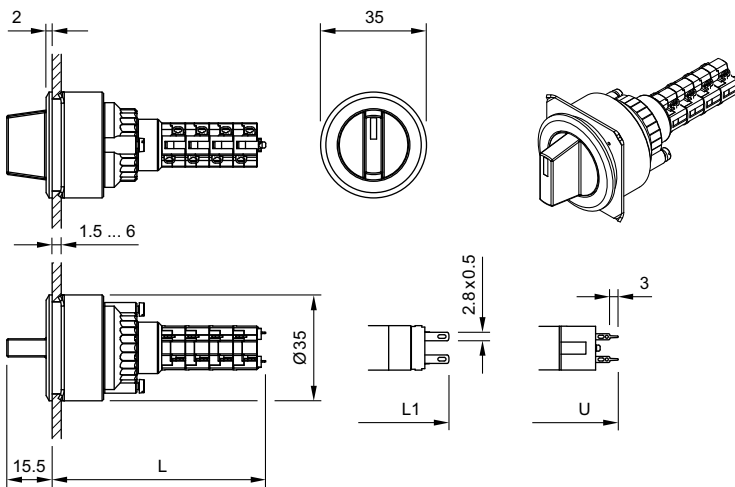

	Soldering terminal	Soldering terminal (also pluggable)	Universal terminal
	L	L1	U
1NC+1NO	46.5	56	-
2NC+2NO	54	-	-
3NC+3NO	61.5	-	-
4NC+4NO	69	-	-
1NC+1NO, 2NC, 2NO			55.5

28 Front bezel set for Mushroom-head pushbutton page 19

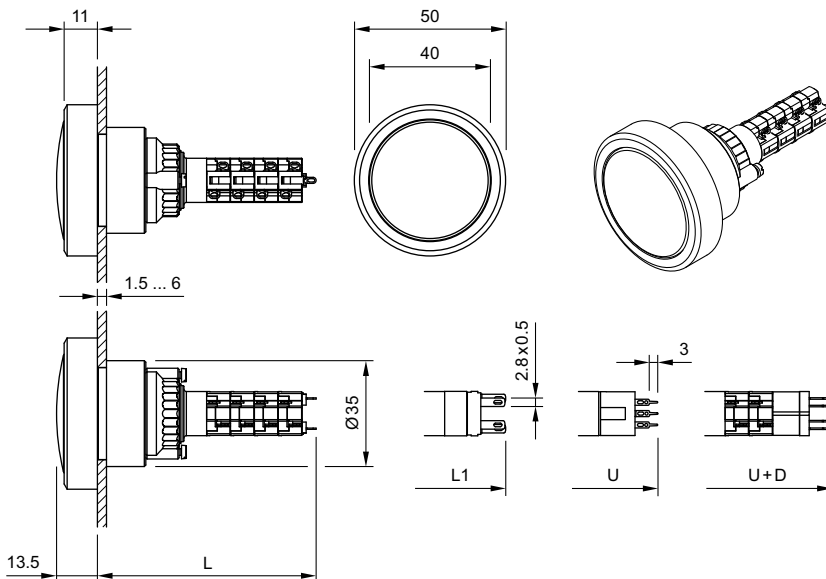

	Soldering terminal	Soldering terminal (also pluggable)	Universal terminal	Universal terminal + diode
	L	L1	U	U+D
1NC+1NO	48.5	56	-	-
2NC+2NO	56	-	-	-
3NC+3NO	63.5	-	-	-
4NC+4NO	71	-	-	-
1NC+1NO+D	-	-	-	63.5
2NC+2NO+D	-	-	-	71
1NC, 1NO, 1NC+1NO, 2NC, 2NO			55.5	-

Circuit drawing

1 Buzzer page 7 | Buzzer, flush mounting page 13

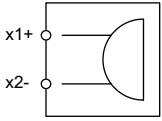

2 Indicator actuator full face illumination page 6 | Indicator actuator front illumination page 6 | Indicator actuator, flush mounting page 13

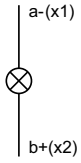

3 Indicator actuator full face illumination page 6 | Indicator actuator front illumination page 6 | Indicator actuator, flush mounting page 13



4 Illuminated actuator pushbutton page 8 | Mushroom-head actuator pushbutton page 9 | Illuminated mushroom-head actuator pushbutton page 10 | Illuminated pushbutton actuator, flush mounting page 14

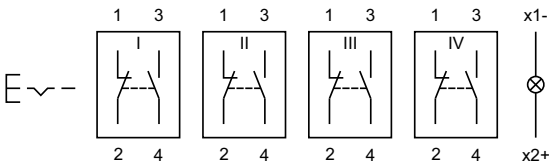

5 Illuminated actuator pushbutton page 8 | Mushroom-head actuator pushbutton page 9 | Illuminated mushroom-head actuator pushbutton page 10 | Illuminated pushbutton actuator, flush mounting page 14

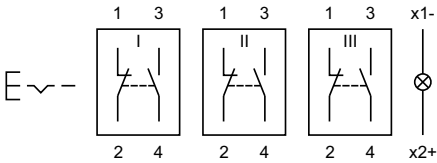

6 Illuminated actuator pushbutton page 8 | Illuminated mushroom-head actuator pushbutton page 10 | Illuminated pushbutton actuator, flush mounting page 14

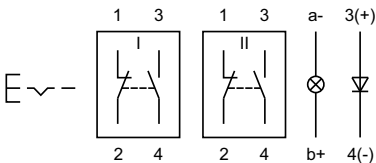

7 Illuminated actuator pushbutton page 8 | Illuminated mushroom-head actuator pushbutton page 10 | Illuminated pushbutton actuator, flush mounting page 14

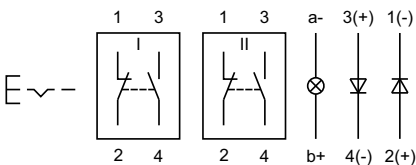

8 Illuminated actuator pushbutton page 8 | **Mushroom-head actuator pushbutton** page 9 | **Illuminated mushroom-head actuator pushbutton** page 10 | **Illuminated pushbutton actuator, flush mounting** page 14

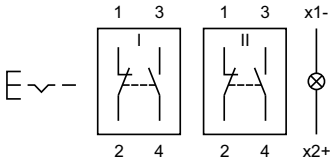

9 Illuminated actuator pushbutton page 8 | **Illuminated mushroom-head actuator pushbutton** page 10 | **Illuminated pushbutton actuator, flush mounting** page 14

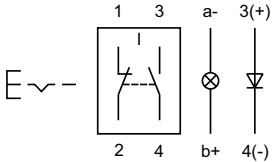

10 Illuminated actuator pushbutton page 8 | **Illuminated mushroom-head actuator pushbutton** page 10 | **Illuminated pushbutton actuator, flush mounting** page 14

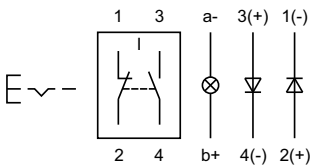

11 Illuminated actuator pushbutton page 8 | **Mushroom-head actuator pushbutton** page 9 | **Illuminated mushroom-head actuator pushbutton** page 10 | **Illuminated pushbutton actuator, flush mounting** page 14

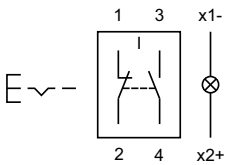

12 Illuminated actuator pushbutton page 8 | **Mushroom-head actuator pushbutton** page 9 | **Illuminated mushroom-head actuator pushbutton** page 10 | **Illuminated pushbutton actuator, flush mounting** page 14

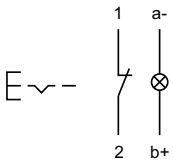

13 Illuminated actuator pushbutton page 8 | **Mushroom-head actuator pushbutton** page 9 | **Illuminated mushroom-head actuator pushbutton** page 10 | **Illuminated pushbutton actuator, flush mounting** page 14

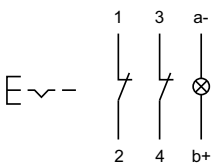

14 Illuminated actuator pushbutton page 8 | **Mushroom-head actuator pushbutton** page 9 | **Illuminated mushroom-head actuator pushbutton** page 10 | **Illuminated pushbutton actuator, flush mounting** page 14

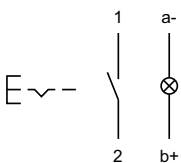

15 Illuminated actuator pushbutton page 8 | Mushroom-head actuator pushbutton page 9 | Illuminated mushroom-head actuator pushbutton page 10 | Illuminated pushbutton actuator, flush mounting page 14

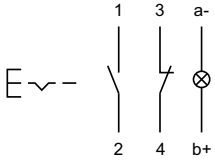

16 Illuminated actuator pushbutton page 8 | Mushroom-head actuator pushbutton page 9 | Illuminated mushroom-head actuator pushbutton page 10 | Illuminated pushbutton actuator, flush mounting page 14

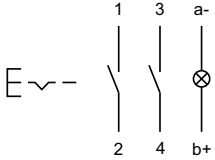

17 Selector switch 2 positions page 12 | Selector switch actuator 2 positions, flush mounting page 16

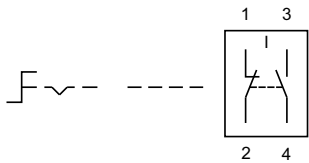

18 Selector switch 2 positions page 12 | Selector switch actuator 2 positions, flush mounting page 16

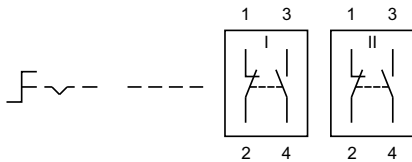

19 Selector switch 2 positions page 12 | Selector switch actuator 2 positions, flush mounting page 16

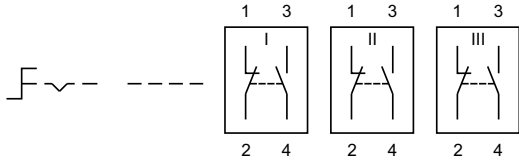

20 Selector switch 2 positions page 12 | Selector switch actuator 2 positions, flush mounting page 16

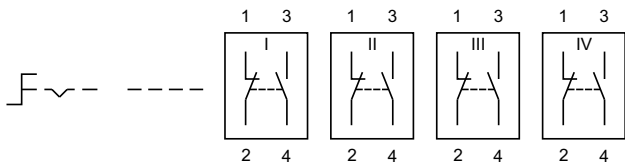

21 Selector switch 2 positions page 12 | Selector switch actuator 2 positions, flush mounting page 16

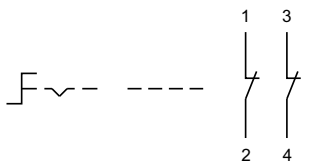

22 Selector switch 2 positions page 12 | Selector switch actuator 2 positions, flush mounting page 16

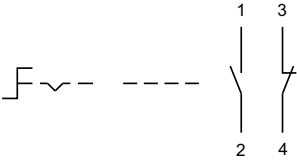

23 Selector switch 2 positions page 12 | Selector switch actuator 2 positions, flush mounting page 16

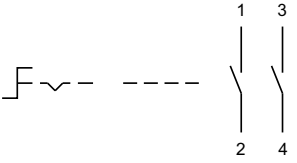

24 Selector switch 2 positions page 12 | Selector switch actuator 2 positions, flush mounting page 16

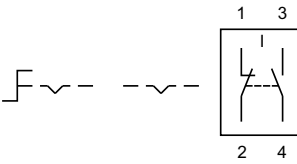

25 Selector switch 2 positions page 12 | Selector switch actuator 2 positions, flush mounting page 16

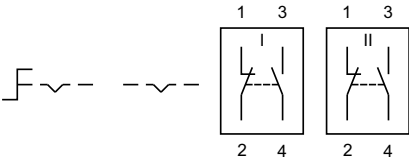

26 Selector switch 2 positions page 12 | Selector switch actuator 2 positions, flush mounting page 16

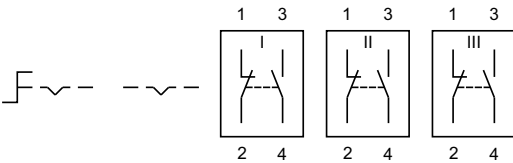

27 Selector switch 2 positions page 12 | Selector switch actuator 2 positions, flush mounting page 16

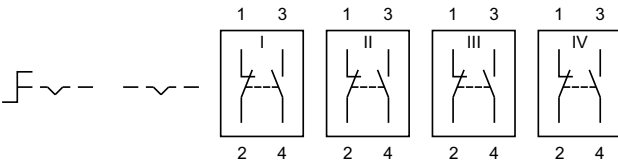

28 Selector switch 2 positions page 12 | Selector switch actuator 2 positions, flush mounting page 16

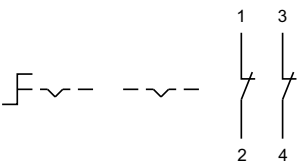

29 Selector switch 2 positions page 12 | Selector switch actuator 2 positions, flush mounting page 16

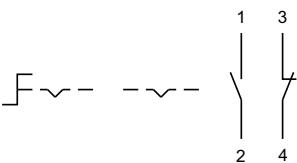

30 Selector switch 2 positions page 12 | Selector switch actuator 2 positions, flush mounting page 16

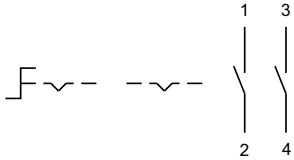

31 Illuminated actuator pushbutton page 8 | Mushroom-head actuator pushbutton page 9 | Illuminated mushroom-head actuator pushbutton page 10 | Illuminated pushbutton actuator, flush mounting page 14

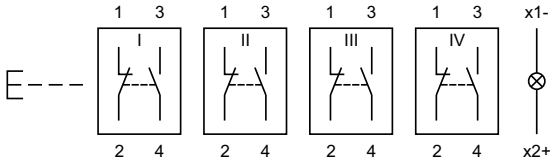

32 Illuminated actuator pushbutton page 8 | Mushroom-head actuator pushbutton page 9 | Illuminated mushroom-head actuator pushbutton page 10 | Illuminated pushbutton actuator, flush mounting page 14

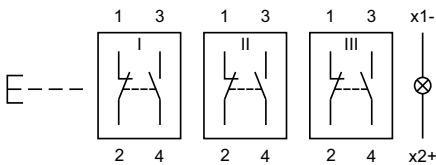

33 Illuminated actuator pushbutton page 8 | Illuminated mushroom-head actuator pushbutton page 10 | Illuminated pushbutton actuator, flush mounting page 14

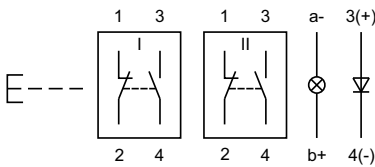

34 Illuminated actuator pushbutton page 8 | Illuminated mushroom-head actuator pushbutton page 10 | Illuminated pushbutton actuator, flush mounting page 14

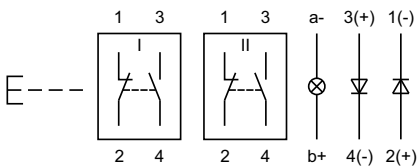

35 Illuminated actuator pushbutton page 8 | Mushroom-head actuator pushbutton page 9 | Illuminated mushroom-head actuator pushbutton page 10 | Illuminated pushbutton actuator, flush mounting page 14

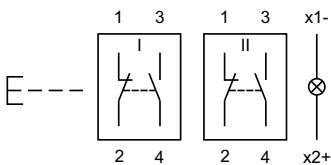

36 Illuminated actuator pushbutton page 8 | Illuminated mushroom-head actuator pushbutton page 10 | Illuminated pushbutton actuator, flush mounting page 14

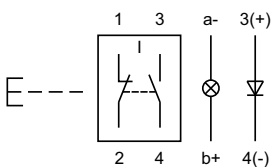

37 Illuminated actuator pushbutton page 8 | **Illuminated mushroom-head actuator pushbutton** page 10 | **Illuminated pushbutton actuator, flush mounting** page 14

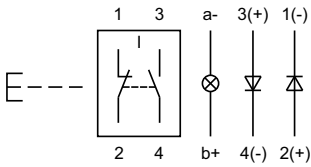

38 Illuminated actuator pushbutton page 8 | **Mushroom-head actuator pushbutton** page 9 | **Illuminated mushroom-head actuator pushbutton** page 10 | **Illuminated pushbutton actuator, flush mounting** page 14

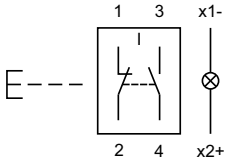

39 Illuminated actuator pushbutton page 8 | **Mushroom-head actuator pushbutton** page 9 | **Illuminated mushroom-head actuator pushbutton** page 10 | **Illuminated pushbutton actuator, flush mounting** page 14

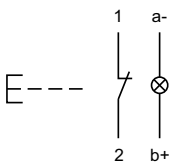

40 Illuminated actuator pushbutton page 8 | **Mushroom-head actuator pushbutton** page 9 | **Illuminated mushroom-head actuator pushbutton** page 10 | **Illuminated pushbutton actuator, flush mounting** page 14

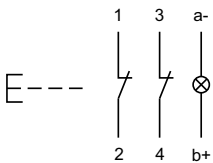

41 Illuminated actuator pushbutton page 8 | **Mushroom-head actuator pushbutton** page 9 | **Illuminated mushroom-head actuator pushbutton** page 10 | **Illuminated pushbutton actuator, flush mounting** page 14

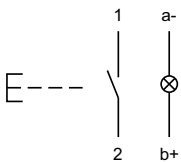

42 Illuminated actuator pushbutton page 8 | **Mushroom-head actuator pushbutton** page 9 | **Illuminated mushroom-head actuator pushbutton** page 10 | **Illuminated pushbutton actuator, flush mounting** page 14

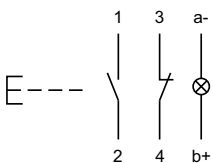

43 Illuminated actuator pushbutton page 8 | **Mushroom-head actuator pushbutton** page 9 | **Illuminated mushroom-head actuator pushbutton** page 10 | **Illuminated pushbutton actuator, flush mounting** page 14

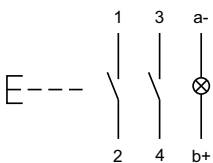

44 Keylock switch 2 positions page 11 | Keylock switch actuator 2 positions, flush mounting page 15

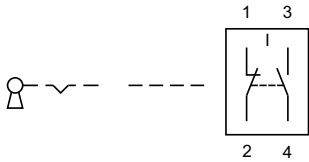

45 Keylock switch 2 positions page 11 | Keylock switch actuator 2 positions, flush mounting page 15

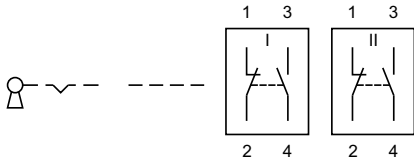

46 Keylock switch 2 positions page 11 | Keylock switch actuator 2 positions, flush mounting page 15

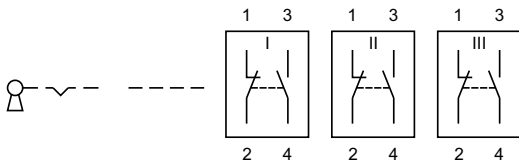

47 Keylock switch 2 positions page 11 | Keylock switch actuator 2 positions, flush mounting page 15

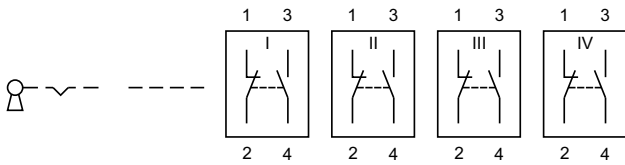

48 Keylock switch 2 positions page 11 | Keylock switch actuator 2 positions, flush mounting page 15

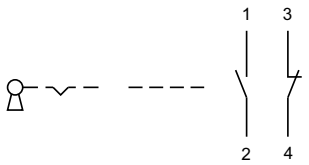

49 Keylock switch 2 positions page 11 | Keylock switch actuator 2 positions, flush mounting page 15

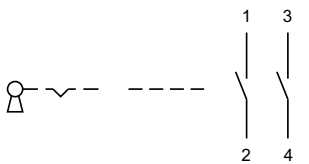

50 Keylock switch 2 positions page 11 | Keylock switch actuator 2 positions, flush mounting page 15

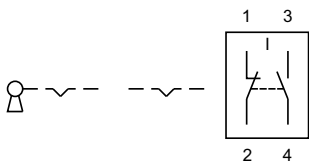

51 Keylock switch 2 positions page 11 | Keylock switch actuator 2 positions, flush mounting page 15

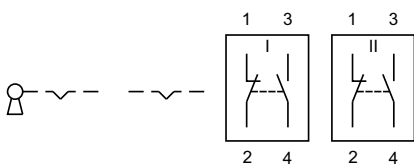

52 Keylock switch 2 positions page 11 | Keylock switch actuator 2 positions, flush mounting page 15

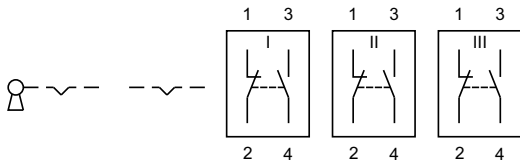

53 Keylock switch 2 positions page 11 | Keylock switch actuator 2 positions, flush mounting page 15

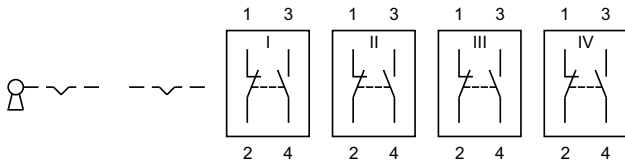

54 Keylock switch 2 positions page 11 | Keylock switch actuator 2 positions, flush mounting page 15

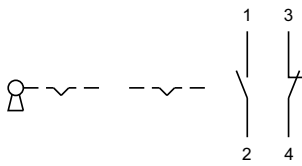

55 Keylock switch 2 positions page 11 | Keylock switch actuator 2 positions, flush mounting page 15

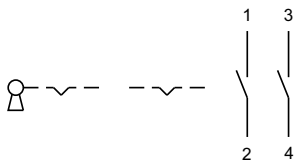

56 Indicator actuator full face illumination page 6

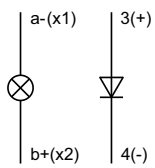

57 Indicator actuator full face illumination page 6

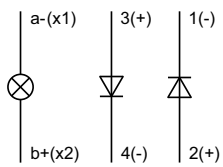

Index from Typ-Nr.

Typ-Nr.	Page	Typ-Nr.	Page	Typ-Nr.	Page
01-928	23	14-133.0252	14	14-337.025K2	11
01-929	23	14-133.0252	8	14-337.025K2	15
02-906	25	14-133.0252	9	14-338.025K2	11
02-912.1	24	14-134.0252	10	14-338.025K2	15
02-912.2	24	14-134.0252	14	14-411.036K	11
02-912.3	24	14-134.0252	8	14-411.036K	15
02-912.4	24	14-134.0252	9	14-412.036K	11
10-1106.1369	23	14-135.022K	11	14-412.036K	15
10-1109.1279	23	14-135.022K	15	14-414.036K	11
10-1109.1329	23	14-135.025K2	11	14-414.036K	15
10-1112.1199	23	14-135.025K2	15	14-415.036K	11
10-1112.1279	23	14-136.025K2	11	14-415.036K	15
10-1113.1249	23	14-136.025K2	15	14-417.036K	11
10-1114.1249	23	14-137.025K2	11	14-417.036K	15
10-1116.1229	23	14-137.025K2	15	14-418.036K	11
10-1119.1199	23	14-138.025K2	11	14-418.036K	15
10-2106.3142	24	14-138.025K2	15	14-431.036	10
10-2106.3144	24	14-141.022K	11	14-431.036	14
10-2106.3145	24	14-141.022K	15	14-431.036	8
10-2106.3146	24	14-141.025K2	11	14-431.036	9
10-2106.3149	24	14-141.025K2	15	14-432.036	10
10-2109.1062	24	14-142.025K2	11	14-432.036	14
10-2109.1064	24	14-142.025K2	15	14-432.036	8
10-2109.1065	24	14-143.025K2	11	14-432.036	9
10-2109.1066	24	14-143.025K2	15	14-433.036	10
10-2109.1069	24	14-144.025K2	11	14-433.036	14
10-2112.1062	24	14-144.025K2	15	14-433.036	8
10-2112.1064	24	14-235.022K	11	14-433.036	9
10-2112.1065	24	14-235.022K	15	14-435.036	10
10-2112.1066	24	14-235.025K2	11	14-435.036	14
10-2112.1069	24	14-235.025K2	15	14-435.036	8
10-2113.1062	24	14-236.025K2	11	14-435.036	9
10-2113.1064	24	14-236.025K2	15	14-436.036	10
10-2113.1065	24	14-237.025K2	11	14-436.036	14
10-2113.1066	24	14-237.025K2	15	14-436.036	8
10-2113.1069	24	14-238.025K2	11	14-436.036	9
10-2119.1042	24	14-238.025K2	15	14-437.036K	11
10-2119.1044	24	14-271.022	10	14-437.036K	15
10-2119.1045	24	14-271.022	14	14-438.036K	11
10-2119.1046	24	14-271.022	8	14-438.036K	15
10-2119.1049	24	14-271.022	9	14-471.036	10
14-030.002	6	14-271.0252	10	14-471.036	14
14-030.005	6	14-271.0252	14	14-471.036	8
14-031.006	6	14-271.0252	8	14-471.036	9
14-040.002	13	14-271.0252	9	14-472.036	10
14-040.002	6	14-272.0252	10	14-472.036	14
14-040.005	13	14-272.0252	14	14-472.036	8
14-040.005	6	14-272.0252	8	14-472.036	9
14-041.006	13	14-272.0252	9	14-473.036	10
14-041.006	6	14-273.0252	10	14-473.036	14
14-131.022	10	14-273.0252	14	14-473.036	8
14-131.022	14	14-273.0252	8	14-473.036	9
14-131.022	8	14-273.0252	9	14-475.036	10
14-131.022	9	14-274.0252	10	14-475.036	14
14-131.0252	10	14-274.0252	14	14-475.036	8
14-131.0252	14	14-274.0252	8	14-475.036	9
14-131.0252	8	14-274.0252	9	14-476.036	10
14-131.0252	9	14-335.022K	11	14-476.036	14
14-132.0252	10	14-335.022K	15	14-476.036	8
14-132.0252	14	14-335.025K2	11	14-476.036	9
14-132.0252	8	14-335.025K2	15	14-501.0220	12
14-132.0252	9	14-336.025K2	11	14-501.0220	16
14-133.0252	10	14-336.025K2	15	14-501.02502	12

Index from Typ-Nr.

Typ-Nr.	Page	Typ-Nr.	Page	Typ-Nr.	Page
14-501.02502	16	14-748.0292	14	704.608.9	19
14-502.02502	12	14-748.0292	8	704.609.0	18
14-502.02502	16	14-749.0292	10	704.609.7	18
14-503.02502	12	14-749.0292	14	704.609.9	18
14-503.02502	16	14-749.0292	8	704.609.9	18
14-504.02502	12	14-750.0292	10	704.610.7	19
14-504.02502	16	14-750.0292	14	704.610.9	19
14-506.0220	12	14-750.0292	8	704.611.2	17
14-506.0220	16	14-810.002	7	704.611.4	17
14-506.02502	12	14-810.902	7	704.611.5	17
14-506.02502	16	14-810.910	13	704.611.7	17
14-507.02502	12	14-810.918	13	704.614.2	18
14-507.02502	16	14-910	25	704.614.4	18
14-508.02502	12	14-958.0	19	704.614.5	18
14-508.02502	16	14-958.8	19	704.614.6	18
14-509.02502	12	14-987.1001	22	704.614.7	18
14-509.02502	16	31-928	23	704.925.0	20
14-515.0360	12	31-929	23	704.925.2	20
14-515.0360	16	31-940	22	704.925.3	20
14-516.0360	12	31-941	22	704.928.18	21
14-516.0360	16	31-942	22	704.928.28	21
14-517.0360	12	31-945	22	704.928.38	21
14-517.0360	16	31-946	22	704.945.1	26
14-520.0360	12	61-9481.6	26	704.945.2	26
14-520.0360	16	700.006.0	25	704.945.3	26
14-521.0360	12	704.600.0	19	704.945.4	26
14-521.0360	16	704.600.1	19	704.945.5	26
14-522.0360	12	704.600.1A	19	704.945.6	26
14-522.0360	16	704.600.2	21	704.953.0	21
14-551.0220	12	704.600.3	21	704.954.0	25
14-551.02502	12	704.600.5/A	21	704.955.0	20
14-552.02502	12	704.600.6	19	704.955.1	20
14-553.02502	12	704.600.9	19	704.955.3	21
14-554.02502	12	704.601.0	17	704.955.4	21
14-556.0220	12	704.601.01	17	704.955.9	20
14-556.02502	12	704.601.2	17	704.955.9E	21
14-557.02502	12	704.601.21	17	704.960.0	25
14-558.02502	12	704.601.4	17	704.960.4	22
14-559.02502	12	704.601.41	17	704.960.8	25
14-565.0360	12	704.601.5	17	704.964.8	22
14-566.0360	12	704.601.51	17	704.968.0	20
14-567.0360	12	704.601.6	17	704.968.1	20
14-570.0360	12	704.601.61	17	704.968.2	20
14-571.0360	12	704.601.8	17	704.968.3	20
14-572.0360	12	704.601.81	17		
14-741.006	6	704.601.9	17		
14-742.006	6	704.601.91	17		
14-743.0292	10	704.602.0	17		
14-743.0292	14	704.602.2	17		
14-743.0292	8	704.602.4	17		
14-744.0292	10	704.602.5	17		
14-744.0292	14	704.602.6	17		
14-744.0292	8	704.602.7	17		
14-745.0292	10	704.603.2	18		
14-745.0292	14	704.603.4	18		
14-745.0292	8	704.603.5	18		
14-746.0292	10	704.603.6	18		
14-746.0292	14	704.603.7	18		
14-746.0292	8	704.604.0	18		
14-747.0292	10	704.604.2	18		
14-747.0292	14	704.604.4	18		
14-747.0292	8	704.604.5	18		
14-748.0292	10	704.608.7	19		

	EAO AG
	Tannwaldstrasse 88 4601 Olten, Switzerland
E-mail	info@eao.com
Website	www.eao.com
	Austria
Phone	+49 201 85 87 0
Fax	+49 201 85 87 210
E-mail	sales.ede@eao.com
	Belgium
Phone	+32 3 777 82 36
Fax	+32 3 777 84 19
E-mail	sales.ebl@eao.com
	China
Phone	+852 27 86 91 41
Fax	+852 27 86 95 61
E-mail	sales.ehk@eao.com
	France
Phone	+33 1 64 43 37 37
Fax	+33 1 64 43 37 49
E-mail	sales.esa@eao.com
	Germany
Phone	+49 201 85 87 0
Fax	+49 201 85 87 210
E-mail	sales.ede@eao.com
	Italy
Phone	+39 035 481 0189
Fax	+39 035 481 3786
E-mail	sales.eit@eao.com
	Japan
Phone	+81 3 5444 5411
Fax	+81 3 5444 0345
E-mail	sales.esj@eao.com
	Netherlands
Phone	+31 78 653 17 00
Fax	+31 78 653 17 99
E-mail	sales.enl@eao.com
	Sweden
Phone	+46 8 683 86 60
Fax	+46 8 724 29 12
E-mail	sales.esw@eao.com
	Switzerland
Phone	+41 62 388 95 00
Fax	+41 62 388 95 55
E-mail	sales.ech@eao.com
	United Kingdom
Phone	+44 1444 236 000
Fax	+44 1444 236 641
E-mail	sales.euk@eao.com
	USA
Phone	+1 203 877 4577
Fax	+1 203 877 3694
E-mail	sales.eus@eao.com
	Other Countries
Phone	+41 62 286 92 10
Fax	+41 62 296 21 62
E-mail	info@eao.com

Данный компонент на территории Российской Федерации

Вы можете приобрести в компании MosChip.

Для оперативного оформления запроса Вам необходимо перейти по данной ссылке:

<http://moschip.ru/get-element>

Вы можете разместить у нас заказ для любого Вашего проекта, будь то серийное производство или разработка единичного прибора.

В нашем ассортименте представлены ведущие мировые производители активных и пассивных электронных компонентов.

Нашей специализацией является поставка электронной компонентной базы двойного назначения, продукции таких производителей как XILINX, Intel (ex.ALTERA), Vicor, Microchip, Texas Instruments, Analog Devices, Mini-Circuits, Amphenol, Glenair.

Сотрудничество с глобальными дистрибьюторами электронных компонентов, предоставляет возможность заказывать и получать с международных складов практически любой перечень компонентов в оптимальные для Вас сроки.

На всех этапах разработки и производства наши партнеры могут получить квалифицированную поддержку опытных инженеров.

Система менеджмента качества компании отвечает требованиям в соответствии с ГОСТ Р ИСО 9001, ГОСТ РВ 0015-002 и ЭС РД 009

Офис по работе с юридическими лицами:

105318, г.Москва, ул.Щербаковская д.3, офис 1107, 1118, ДЦ «Щербаковский»

Телефон: +7 495 668-12-70 (многоканальный)

Факс: +7 495 668-12-70 (доб.304)

E-mail: info@moschip.ru

Skype отдела продаж:

moschip.ru

moschip.ru_4

moschip.ru_6

moschip.ru_9