

FEATURES

- Adjustable gain**
- High common-mode voltage range**
7 V to 65 V typical
7 V to >500 V with external pass transistor
- Current output**
- Integrated 5 V series regulator**
- 8-lead MSOP package**
- Operating temperature range of -40°C to $+125^{\circ}\text{C}$**

APPLICATIONS

- Current shunt measurement**
- Motor controls**
- DC-to-DC converters**
- Power supplies**
- Battery monitoring**
- Remote sensing**

GENERAL DESCRIPTION

The AD8212 is a high common-mode voltage, current shunt monitor. It accurately amplifies a small differential input voltage in the presence of large common-mode voltages up to 65 V (>500 V with an external PNP transistor).

The AD8212 is ideal for current monitoring across a shunt resistor in applications controlling loads, such as motors and solenoids. The current output of the device is proportional to the input differential voltage. The user can select an external resistor to set the desired gain. The typical common-mode voltage range of the AD8212 is 7 V to 65 V.

FUNCTIONAL BLOCK DIAGRAM

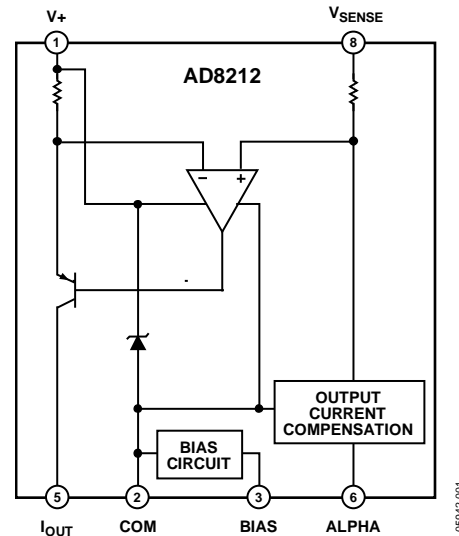

Figure 1.

Another feature of the AD8212 is high voltage operation, which is achieved by using an external high voltage breakdown PNP transistor. In this configuration, the common-mode range of the AD8212 is equal to the breakdown of the external PNP transistor. Therefore, operation at several hundred volts is easily achieved (see Figure 23).

The AD8212 features a patented output base current compensation circuit for high voltage operation mode. This ensures that no base current is lost through the external transistor and excellent output accuracy is maintained regardless of common-mode voltage or temperature.

TABLE OF CONTENTS

Features	1	Normal Operation (7 V to 65 V Supply (V+) Range).....	9
Applications.....	1	High Voltage Operation Using an External PNP Transistor...	10
Functional Block Diagram	1	Output Current Compensation Circuit.....	10
General Description	1	Applications Information	11
Revision History	2	General High-Side Current Sensing	11
Specifications.....	3	Motor Control.....	11
Absolute Maximum Ratings.....	4	500 V Current Monitor	11
ESD Caution.....	4	Bidirectional Current Sensing	12
Pin Configuration and Function Descriptions.....	5	Outline Dimensions	13
Typical Performance Characteristics	6	Ordering Guide	13
Theory of Operation	9		

REVISION HISTORY

5/2017—Rev. B to Rev. C

Changes to Figure 6.....	6
Changes to Figure 10.....	7
Updated Outline Dimensions	13

5/2009—Rev. A to Rev. B

Changes to Ordering Guide	13
---------------------------------	----

11/2007—Rev. 0 to Rev. A

Increased Operating Temperature Range.....	Universal
--	-----------

5/2007—Revision 0: Initial Version

SPECIFICATIONS

$V_S = 15\text{ V}$, $T_{OPR} = -40^\circ\text{C}$ to $+125^\circ\text{C}$, $T_A = 25^\circ\text{C}$, unless otherwise noted.

Table 1.

Parameter	Conditions/Comments	Min	Typ	Max	Unit
SUPPLY VOLTAGE (V_+)	No external pass transistor	7		65	V
	With external PNP transistor ¹	7		>500	V
SUPPLY CURRENT ²	($I_{SUPPLY} = I_{OUT} + I_{BIAS}$) $V_+ = 7\text{ V}$ to 65 V	220		720	μA
	High voltage operation, using external PNP	200		1500	μA
VOLTAGE OFFSET					
Offset Voltage (RTI)	T_A			± 2	mV
Over Temperature (RTI)	T_{OPR}			± 3	mV
Offset Drift	T_{OPR}			± 10	$\mu\text{V}/^\circ\text{C}$
INPUT					
Input Impedance					
Differential			2		$\text{k}\Omega$
Common Mode (V_{CM})	$V_+ = 7\text{ V}$ to 65 V		5		$\text{M}\Omega$
Voltage Range					
Differential	Maximum voltage between V_+ and V_{SENSE}			500	mV
V_{SENSE} (Pin 8) Current ³	$V_+ = 7\text{ V}$ to 65 V , T_{OPR}		100	200	nA
OUTPUT					
Transconductance			1000		$\mu\text{A}/\text{V}$
Current Range (I_{OUT})	$7\text{ V} \leq V_+ \leq 65\text{ V}$, 0 mV to 500 mV differential input			500	μA
Gain Error for T_{OPR}	$7\text{ V} \leq V_+ \leq 65\text{ V}$, with respect to 500 μA full scale			± 1	%
Impedance			20		$\text{M}\Omega$
Voltage Range		0		$V_+ - 5$	V
REGULATOR					
Nominal Value	$7\text{ V} \leq V_+ \leq 65\text{ V}$	4.80	5	5.20	V
PSRR	$7\text{ V} \leq V_+ \leq 65\text{ V}$	80			dB
Bias Current (I_{BIAS})	T_{OPR} , $7\text{ V} \leq V_+ \leq 65\text{ V}$		185	200	μA
	T_{OPR} , high voltage operation	200		1000	μA
DYNAMIC RESPONSE					
Small Signal -3 dB Bandwidth	Gain = 10		1000		kHz
	Gain = 20		500		kHz
	Gain = 50		100		kHz
Settling Time	Within 0.1% of the true output, gain = 20		2		μs
ALPHA PIN INPUT CURRENT				25	μA
NOISE					
0.1 Hz to 10 Hz, RTI			1.1		$\mu\text{V p-p}$
Spectral Density, 1 kHz, RTI			40		$\text{nV}/\sqrt{\text{Hz}}$
TEMPERATURE RANGE					
For Specified Performance (T_{OPR})		-40		+125	$^\circ\text{C}$

¹ Range dependent on the V_{CE} breakdown of the transistor.

² The AD8212 supply current in normal voltage operation ($V_+ = 7\text{ V}$ to 65 V) is the bias current (I_{BIAS}) added to output current (I_{OUT}). Output current varies upon input differential voltage and can range from 0 μA to 500 μA . I_{BIAS} in this mode of operation is typically 185 μA and 200 μA maximum. For high voltage operation mode, refer to the High Voltage Operation Using an External PNP Transistor section.

³ The current of the amplifier into V_{SENSE} (Pin 8) increases when operating in high voltage mode. See the High Voltage Operation Using an External PNP Transistor section for more information.

ABSOLUTE MAXIMUM RATINGS

T_{OPR} = -40°C to +125°C, unless otherwise noted.

Table 2.

Parameter	Rating
Supply Voltage	65 V
Continuous Input Voltage	68 V
Reverse Supply Voltage	0.3 V
Operating Temperature Range	-40°C to +125°C
Storage Temperature Range	-40°C to +150°C
Output Short-Circuit Duration	Indefinite

Stresses at or above those listed under Absolute Maximum Ratings may cause permanent damage to the product. This is a stress rating only; functional operation of the product at these or any other conditions above those indicated in the operational section of this specification is not implied. Operation beyond the maximum operating conditions for extended periods may affect product reliability.

ESD CAUTION



ESD (electrostatic discharge) sensitive device. Charged devices and circuit boards can discharge without detection. Although this product features patented or proprietary protection circuitry, damage may occur on devices subjected to high energy ESD. Therefore, proper ESD precautions should be taken to avoid performance degradation or loss of functionality.

PIN CONFIGURATION AND FUNCTION DESCRIPTIONS

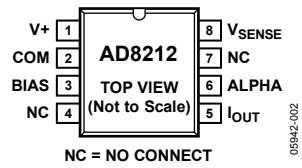

Figure 2. Pin Configuration

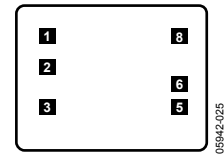

Figure 3. Metallization Diagram

Table 3. Pin Function Descriptions

Pin No.	Mnemonic	X Coordinate	Y Coordinate	Description
1	V+	-393	+219	Supply Voltage (Inverting Amplifier Input).
2	COM	-392	+67	Regulator Low Side.
3	BIAS	-392	-145	Bias Circuit Low Side.
4	NC	-	-	No Connect.
5	I _{OUT}	+386	-82	Output Current.
6	ALPHA	+386	+23	Current Compensation Circuit Input.
7	NC	+386	+118	No Connect.
8	V _{SENSE}	+386	+210	Noninverting Amplifier Input.

TYPICAL PERFORMANCE CHARACTERISTICS

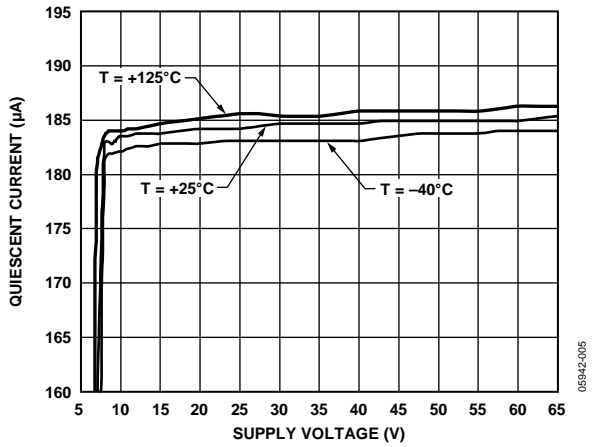

Figure 4. Supply Current vs. Supply (Pin V+) ($I_{OUT} = 0\text{ mA}$)

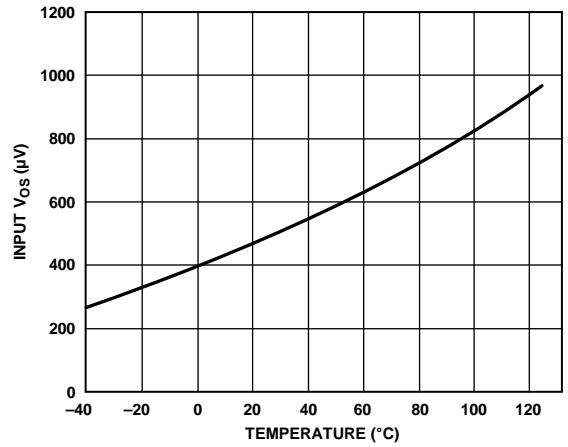

Figure 7. Input Offset Voltage vs. Temperature

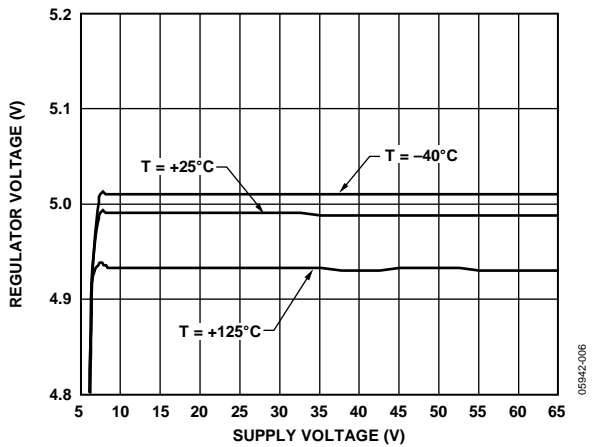

Figure 5. Regulator Voltage vs. Supply (Pin V+)

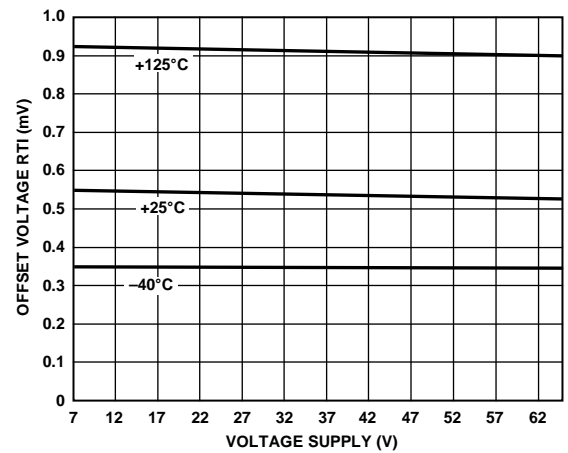

Figure 8. Input Offset Voltage vs. Supply (Pin V+)

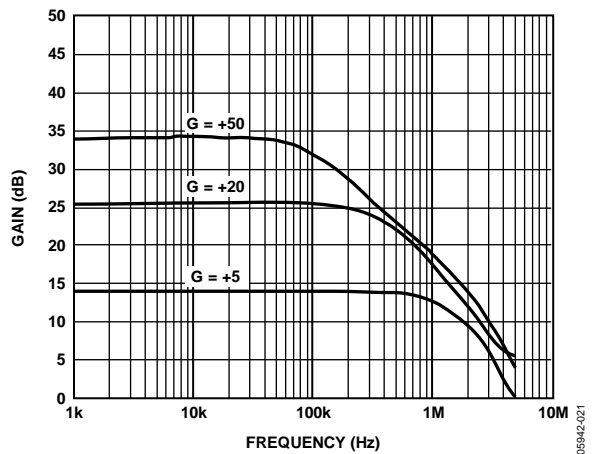

Figure 6. Gain vs. Frequency

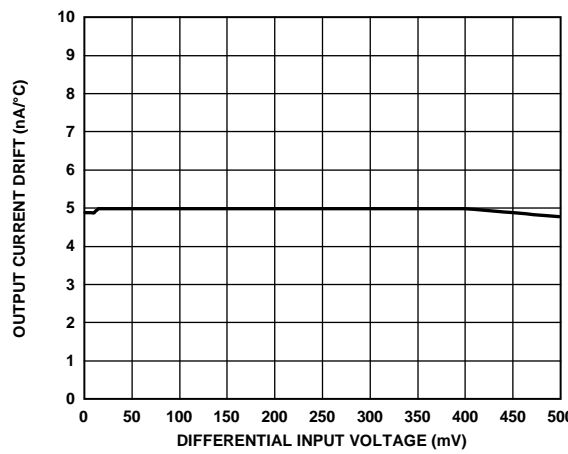

Figure 9. Output Current Drift vs. Differential Input Voltage

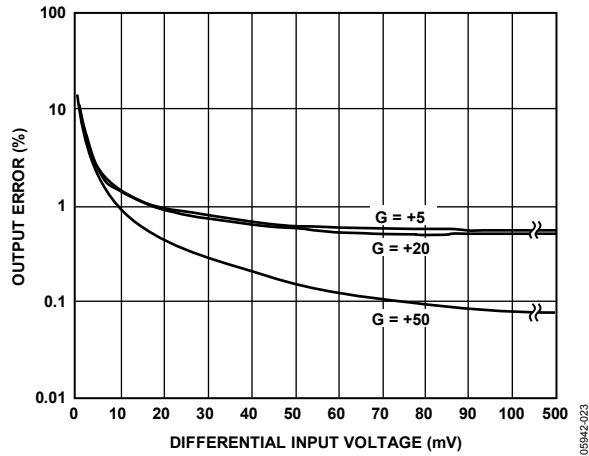

Figure 10. Total Output Error Due to Input Offset vs. Differential Input Voltage

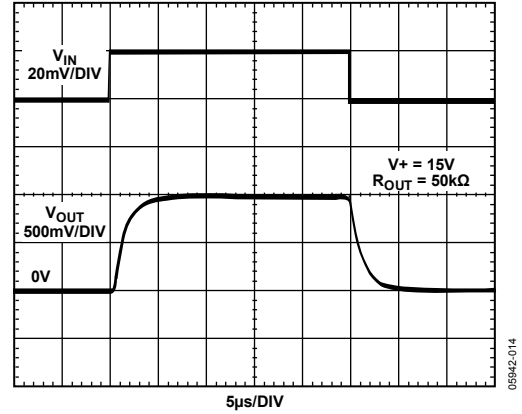

Figure 13. Step Response (Gain = 50)

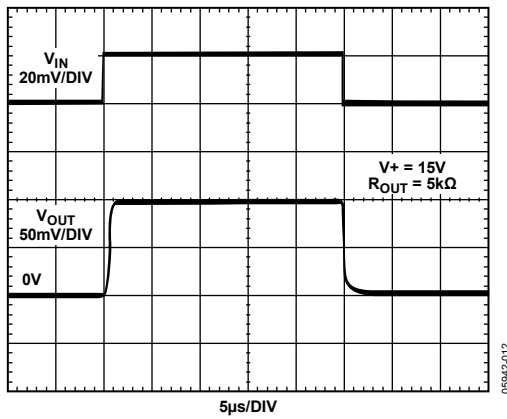

Figure 11. Step Response (Gain = 5)

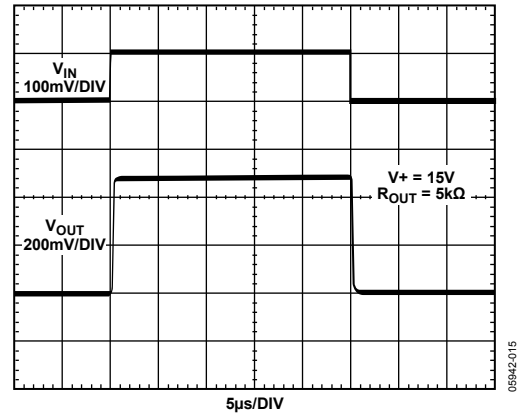

Figure 14. Step Response (Gain = 5)

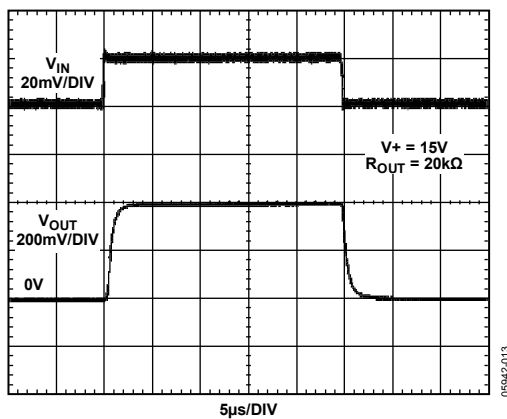

Figure 12. Step Response (Gain = 20)

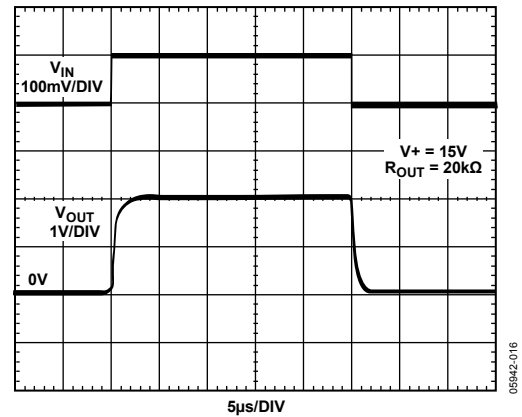

Figure 15. Step Response (Gain = 20)

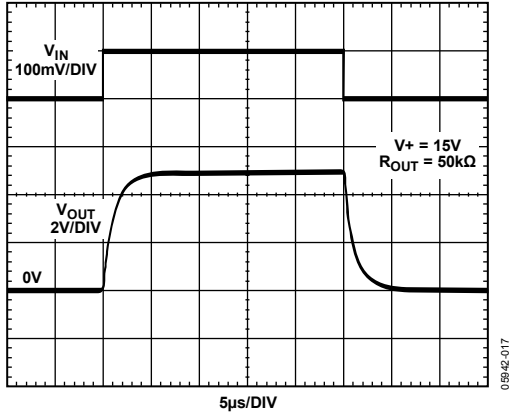

Figure 16. Step Response (Gain = 50)

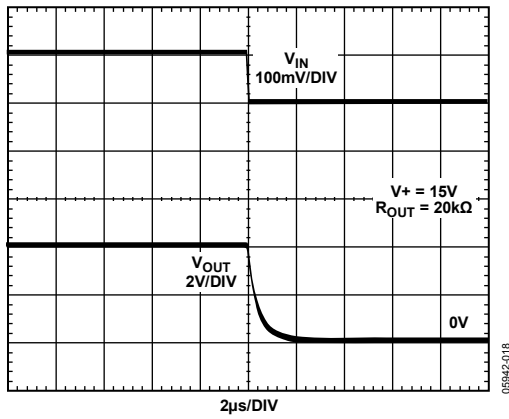

Figure 17. Step Response Falling

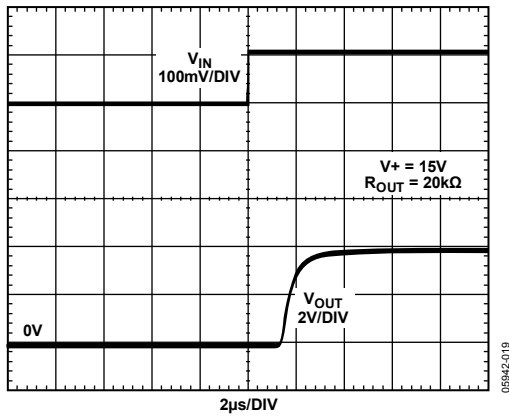

Figure 18. Step Response Rising

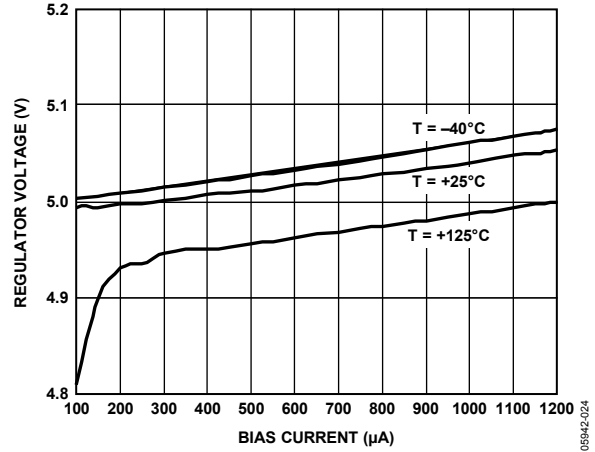

Figure 19. Regulator Voltage High Voltage Mode ($I_{OUT} = 0$ mA) vs. Bias Current

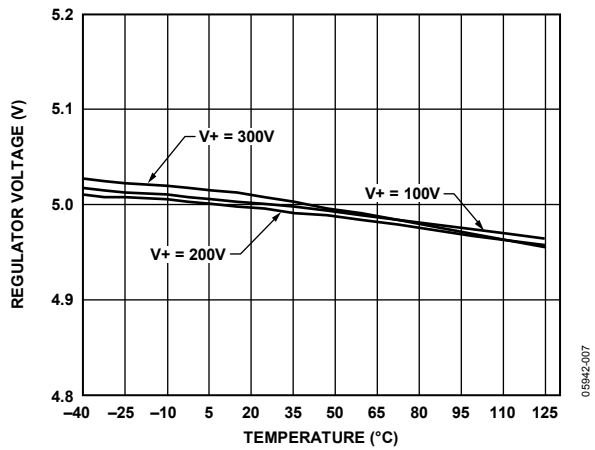

Figure 20. Regulator Voltage vs. Temperature (High Voltage Operation)

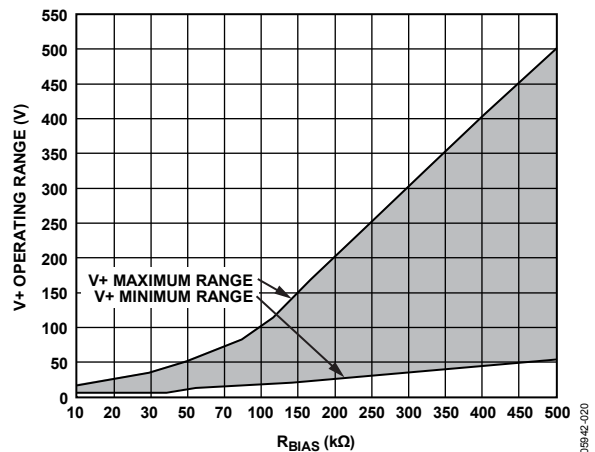

Figure 21. Supply Range (V_+) vs. Bias Resistor Value (High Voltage Operation)

THEORY OF OPERATION

NORMAL OPERATION (7 V TO 65 V SUPPLY (V+) RANGE)

In typical applications, the AD8212 measures a small differential input voltage generated by a load current flowing through a shunt resistor.

The operational amplifier (A1) is connected across the shunt resistor (R_{SHUNT}) with its inverting input connected to the battery/supply side, and the noninverting input connected to the load side of the system. Amplifier A1 is powered via an internal series regulator (depicted as a Zener diode in Figure 22). This regulator maintains a constant 5 V between the battery/supply terminal of the AD8212 and COM (Pin 2), which represents the lowest common point of the internal circuitry.

A load current flowing through the external shunt resistor produces a voltage at the input terminals of the AD8212. Amplifier A1 responds by causing Transistor Q1 to conduct the necessary current through Resistor R1 to equalize the potential at both the inverting and noninverting inputs of Amplifier A1.

The current through the emitter of Transistor Q1 (I_{OUT}) is proportional to the input voltage (V_{SENSE}), and, therefore, the load current (I_{LOAD}) through the shunt resistor (R_{SHUNT}). The output current (I_{OUT}) is converted to a voltage by using an external resistor, the value of which is dependent on the input to output gain equation desired in the application.

The transfer function for the AD8212 is

$$I_{OUT} = (g_m \times V_{SENSE})$$

$$V_{SENSE} = I_{LOAD} \times R_{SHUNT}$$

$$V_{OUT} = I_{OUT} \times R_{OUT}$$

$$V_{OUT} = (V_{SENSE} \times R_{OUT})/1000$$

where:

$$g_m = 1000 \mu A/V.$$

In normal voltage operation mode, the bias circuit is connected to GND, as shown in Figure 22. In this mode, I_{BIAS} is typically 185 μA throughout the 7 V to 65 V (V+) range.

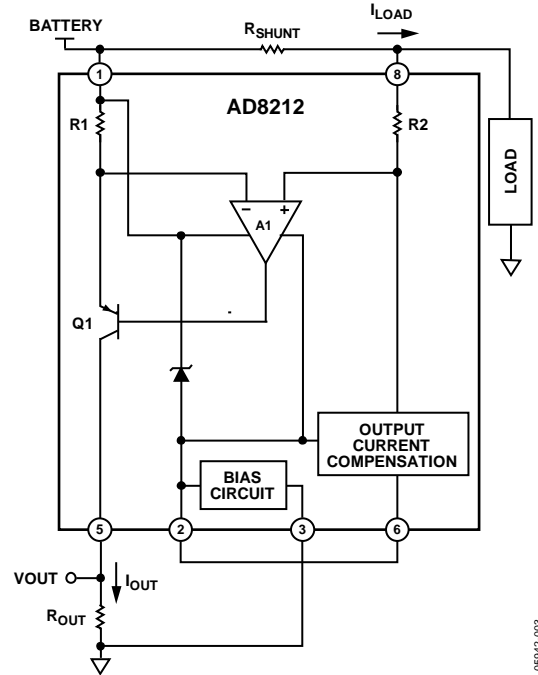

Figure 22. Typical Connection (7V to 65V Supply (Pin V+) Range)

When using the AD8212 as described, the battery/supply voltage in the system must be between 7 V to 65 V. The 7 V minimum supply range is necessary to turn on the internal regulator (shown as a Zener diode in Figure 22). This regulated voltage then remains a constant 5 V, regardless of the supply (V+) voltage. The 65 V maximum limit in this mode of operation is due to the breakdown voltage limitation of the AD8212 process.

Typically, a 1% resistor can be used to convert the output current to a voltage. Table 4 provides suggested R_{OUT} values.

Table 4. Suggested R_{OUT} Values

Gain (V/V)	R_{OUT} (k Ω)
1	1
10	10
20	20
50	49.9
100	100

APPLICATIONS INFORMATION

GENERAL HIGH-SIDE CURRENT SENSING

The AD8212 output is intended to drive high impedance nodes. Therefore, if interfacing with a converter, it is recommended that the output voltage across R_{OUT} be buffered, so that the gain of the AD8212 is not affected.

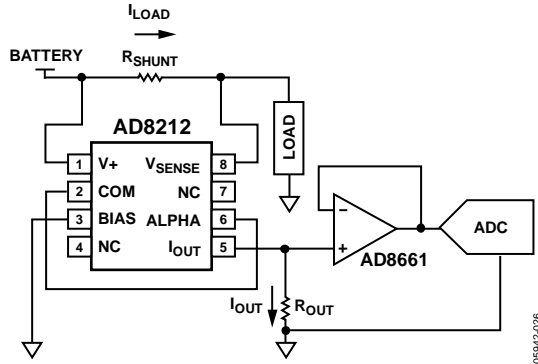

NOTES
1. NC = NO CONNECT.

Figure 24. Normal Voltage Range Operation

Careful calculations must be made when choosing a gain resistor so as not to exceed the input voltage range of the converter. The output of the AD8212 can be as high as $(V+) - 5V$. However, the true output maximum voltage is dependent upon the differential input voltage, and the resulting output current across R_{OUT} , which can be as high as 500 μA (based on a 500 mV maximum input differential limit).

MOTOR CONTROL

The AD8212 is a practical solution for high-side current sensing in motor control applications. In cases where the shunt resistor is referenced to battery and the current flowing is unidirectional, as shown in Figure 25, the AD8212 monitors the current with no additional supply pin necessary.

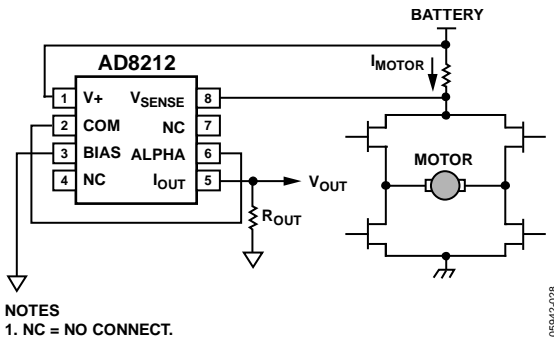

NOTES
1. NC = NO CONNECT.

Figure 25. High-Side Current Sensing for Motor Control

500 V CURRENT MONITOR

As noted in the High Voltage Operation Using an External PNP Transistor section, the AD8212 common-mode voltage range is extended by using an external PNP transistor. This mode of operation is achievable with many amplifiers featuring a current output. However, typically an external Zener regulator must be added, along with a FET device, to withstand the common-mode voltage and maintain output current accuracy.

The AD8212 features an integrated regulator (which acts as a Zener regulator). It offers output current compensation that allows the user to maintain excellent output current accuracy by using any PNP transistor. Reliability is increased due to lower component count. Most importantly, the output current accuracy is high, allowing the user to choose an inexpensive PNP transistor to withstand the increased common-mode voltage.

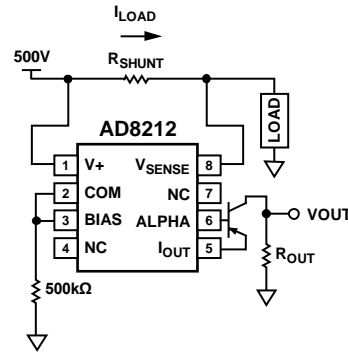

NOTES
1. TRANSISTOR V_{CE} BREAKDOWN VOLTAGE MUST BE 500V.
2. NC = NO CONNECT.

Figure 26. High Voltage Operation Using External PNP

BIDIRECTIONAL CURRENT SENSING

The AD8212 is a unidirectional current sensing device. Therefore, in power management applications where both the charge and load currents must be monitored, two devices can be used and connected as shown in Figure 27. In this case,

V_{OUT1} increases as I_{LOAD} flows through the shunt resistor. V_{OUT2} increases when I_{CHARGE} flows through the input shunt resistor.

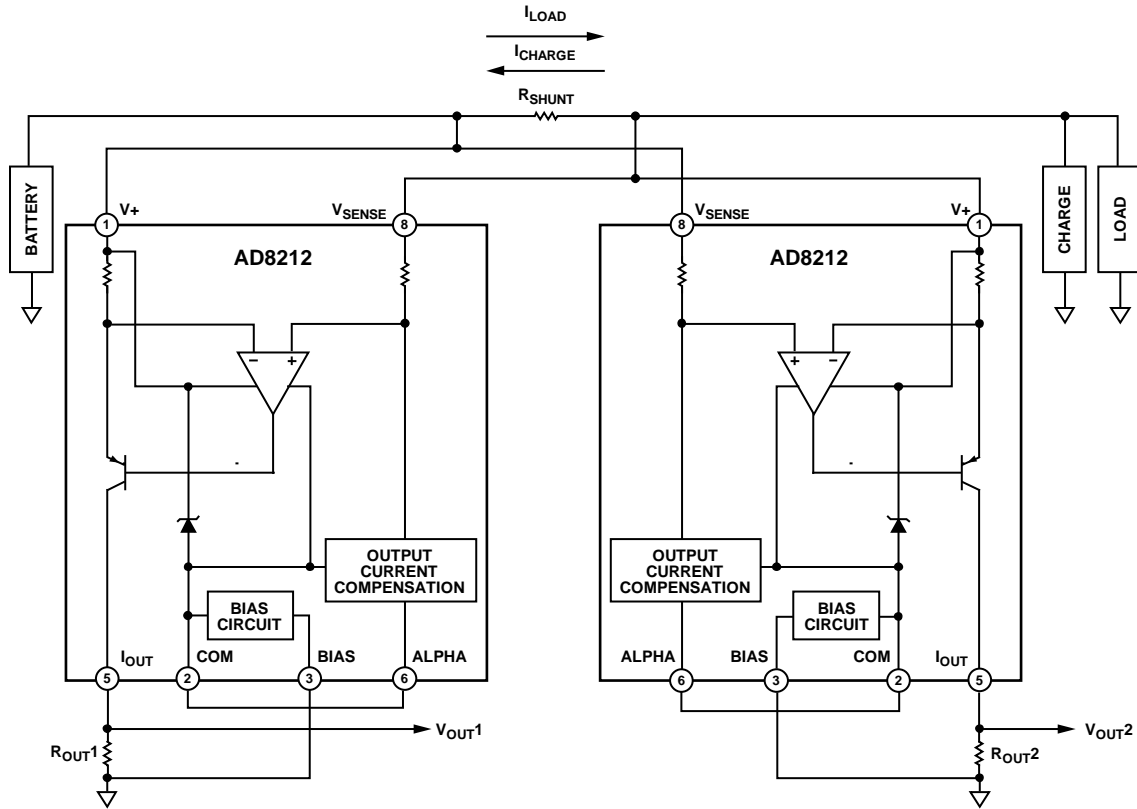
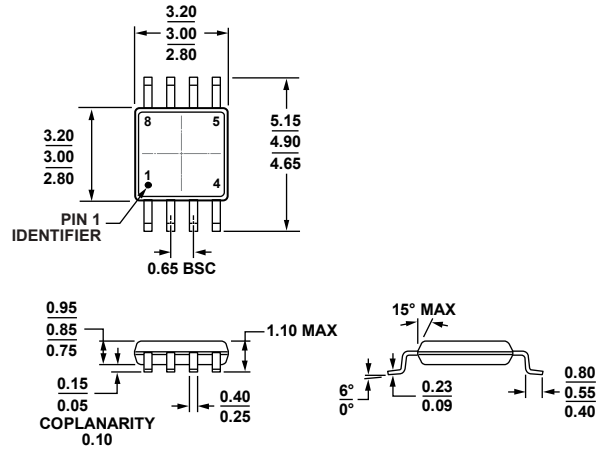

Figure 27. Bidirectional Current Sensing

05842-011

OUTLINE DIMENSIONS



COMPLIANT TO JEDEC STANDARDS MO-187-AA

Figure 28. 8-Lead Mini Small Outline Package [MSOP] (RM-8)

Dimensions shown in millimeters

10-07-2009B

ORDERING GUIDE

Model ¹	Temperature Range	Package Description	Package Option	Branding
AD8212YRMZ	-40°C to +125°C	8-Lead MSOP	RM-8	Y04
AD8212YRMZ-RL	-40°C to +125°C	8-Lead MSOP, 13" Tape and Reel	RM-8	Y04
AD8212YRMZ-R7	-40°C to +125°C	8-Lead MSOP, 7" Tape and Reel	RM-8	Y04
AD8212WYRMZ	-40°C to +125°C	8-Lead MSOP	RM-8	Y25
AD8212WYRMZ-RL	-40°C to +125°C	8-Lead MSOP, 13" Tape and Reel	RM-8	Y25
AD8212WYRMZ-R7	-40°C to +125°C	8-Lead MSOP, 7" Tape and Reel	RM-8	Y25

¹ Z = RoHS Compliant Part.

Данный компонент на территории Российской Федерации

Вы можете приобрести в компании MosChip.

Для оперативного оформления запроса Вам необходимо перейти по данной ссылке:

<http://moschip.ru/get-element>

Вы можете разместить у нас заказ для любого Вашего проекта, будь то серийное производство или разработка единичного прибора.

В нашем ассортименте представлены ведущие мировые производители активных и пассивных электронных компонентов.

Нашей специализацией является поставка электронной компонентной базы двойного назначения, продукции таких производителей как XILINX, Intel (ex.ALTERA), Vicor, Microchip, Texas Instruments, Analog Devices, Mini-Circuits, Amphenol, Glenair.

Сотрудничество с глобальными дистрибьюторами электронных компонентов, предоставляет возможность заказывать и получать с международных складов практически любой перечень компонентов в оптимальные для Вас сроки.

На всех этапах разработки и производства наши партнеры могут получить квалифицированную поддержку опытных инженеров.

Система менеджмента качества компании отвечает требованиям в соответствии с ГОСТ Р ИСО 9001, ГОСТ РВ 0015-002 и ЭС РД 009

Офис по работе с юридическими лицами:

105318, г.Москва, ул.Щербаковская д.3, офис 1107, 1118, ДЦ «Щербаковский»

Телефон: +7 495 668-12-70 (многоканальный)

Факс: +7 495 668-12-70 (доб.304)

E-mail: info@moschip.ru

Skype отдела продаж:

moschip.ru

moschip.ru_4

moschip.ru_6

moschip.ru_9