



Amphenol

ENTERTAINMENT INTERCONNECT CATALOGUE

Amphenol Australia Pty Ltd



Amphenol Australia Pty. Ltd.

Amphenol Australia's head office is based in Melbourne, Victoria and is the Sales, Marketing and Engineering centre of excellence for an extensive range of professional connector and cabling products. Satellite facilities of Amphenol Australia also exist in Colorado and Los Angeles, in the USA as well as Shenzhen, China.

Amphenol's global presence allows us to take full advantage of our numerous corporate resources and product portfolio to provide you with a vast offering and choice. Our extensive range is designed to meet the specific needs of the entertainment markets to make the selection of your interconnect partner an easy choice.

The Amphenol Audio international brand name was launched by Amphenol Australia in 2006 and represents the flag ship of one of the company's main core businesses and specialist product ranges. The company has been producing

products for the pro-audio industry for over fifty years. Since the development of our XLR AC Series connectors, we have continued to provide our customers with exacting quality in an increasingly competitive environment.

























Amphenol Australia's award winning IDC (Insulation Displacement Contact) XLR showcases the company's commitment to both Engineering Excellence and "Green Gigging" philosophies. It is the world's first XLR to use solderless technology for a pro-audio microphone cabling application. It allows for cable assemblies to be made, or repairs performed to assemblies in the field, without the need for solder, resins and fluxes or externally powered soldering stations.

Continuous improvement through ISO9001, a focus on environmental awareness and development of next generation industry leading products is our philosophy. As the entertainment

industry moves into the future the emerging technologies from other industries has become more prevalent and more challenging. Amphenol Australia's global presence combined with its close technical relationships with other Amphenol sister divisions, each a specialist and leader in their own interconnect field, places it well to support innovation and meet this challenge head on.

The ability of Amphenol to provide a full range of design services required to support the customers applications design and modelling, applications engineering, fabrication, value-added assembly and testing, coupled with the largest interconnect offering on the market means that we can support all of your system level needs.

CONTENTS

		PAGE	
	AX SERIES XLR CABLE CONNECTORS	3	
	METAL SHELL TYPE - SOLDER	4	
	AC SERIES XLR CABLE CONNECTORS	9	
	METAL SHELL TYPE - SOLDER	10	
	THERMOPLASTIC SHELL TYPE - SOLDER	14	
	METAL SHELL TYPE RIGHT ANGLE - SOLDER	15	
	METAL SHELL TYPE - IDC (SOLDERLESS)	16	
	THERMOPLASTIC SHELL TYPE - IDC (SOLDERLESS)	18	
	AC "Z" SERIES XLR METAL CHASSIS MOUNT CONNECTORS	22	
	METAL D TYPE FLANGE - SOLDER AND PCB	23	
	METAL P TYPE FLANGE - SOLDER AND PCB	26	
	AC SERIES XLR PCB CHASSIS MOUNT CONNECTORS	34	
	THERMOPLASTIC A - TYPE FLANGE 3 CONTACT	35	
	METAL B - TYPE FLANGE 3 CONTACT	39	
	THERMOPLASTIC A - TYPE FLANGE 5 CONTACT	43	
	AC SERIES DUAL 1/4" (6.35mm) / XLR	50	
	C - TYPE LOW PROFILE DUAL JACK / XLR CONNECTORS	51	
	C - TYPE DUAL JACK / XLR CONNECTORS	53	
	AC SERIES XLR THERMOPLASTIC CHASSIS MOUNT CONNECTORS	59	
	THERMOPLASTIC D - TYPE FLANGE	60	
	THERMOPLASTIC TYPE - IDC (SOLDERLESS)	62	
	SP/EP/AP SERIES HIGH POWER / LOUDSPEAKER CONNECTORS	67	
	SP SERIES LOUDSPEAKER CONNECTORS	68	
	EP METAL TYPE - SOLDER	76	
	AP THERMOPLASTIC TYPE - SOLDER	78	
	XLRnet SERIES	81	
	RJ45 CABLE PLUG HOUSING	81	
	RJ45 PCB CHASSIS MOUNT CONNECTORS	85	
	BNC 75 Ω RF CONNECTORS	89	
	BNC 75Ω RF CONNECTORS	90	
	BNC PATCH PANELS	92	
	1/4" PHONE CONNECTORS	95	
	T-SERIES	97	
	T-SERIES SWITCHPLUG	99	
	MUSICIAN SERIES II	104	
	1/4" PHONE JACK CONNECTORS	109	
	PLUGS AND SOCKETS	118	
	3.5mm K-SERIES	119	
	RCA SERIES	121	
	G-TYPE MINIATURE XLR	123	
	MULTIPIN CONNECTORS	127	
	MP-41 SERIES	128	
	MP-62/MP-65 SERIES	133	
	ACCESSORIES	137	
	CONNECTOR WIRING INFORMATION	140	
	INDEX	142	

NEW ITEM

NEW ITEM

NEW ITEM

NEW ITEM

NEW ITEM

ACC.

ISO VIEW OF AX SERIES XLR CABLE CONNECTOR

One piece ground / latch spring design incorporating twin wipe contacts for a direct connection path from mating shell to ground providing enhanced connection and EMI performance

Precision socket contacts with compact solder buckets reduce termination time and material wastage during soldering.

Leading first mate last break socket contact (Pin 1)

Concentric socket contact design provides optimal contact resistance

Oversized ergonomic latch for quick and easy mating

Chuck style cable clamp c/w split opening for the widest cable acceptance range

O-ring provides vibration resistance and sealing.

Overmolded boot with flex bend relief for improved aesthetics, cable protection and boot retention.

Ergonomic sleeve with integrated expansion ring. Channel I.D capability.

Zinc Diecast Shell for robustness and wear resistance.

Concealed latching point for improved aesthetics, sealing and strength.

Ground solder tag.

Precision Machined Pin contacts with compact solder buckets reduce termination time and material wastage during soldering.

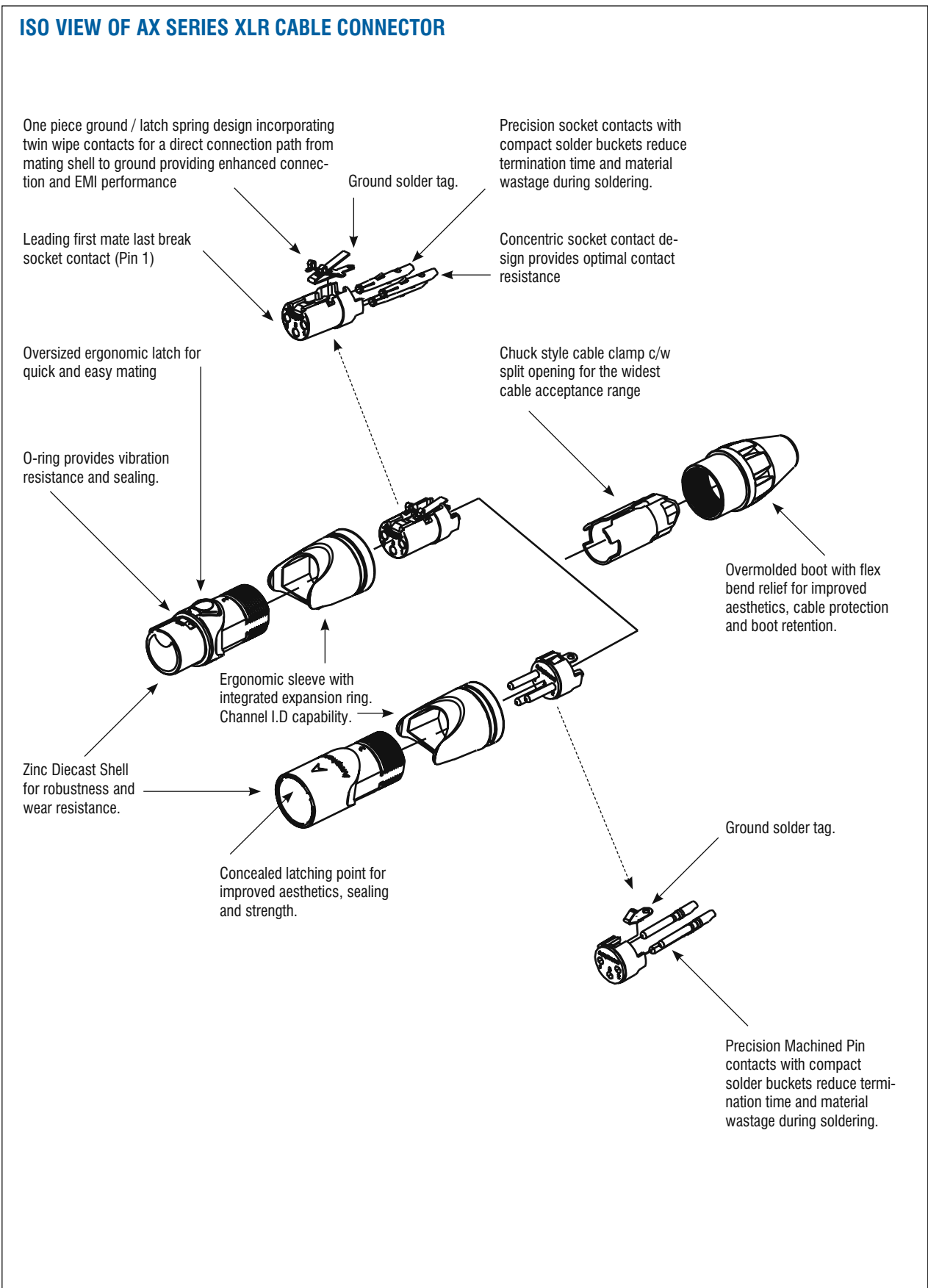



AX SERIES XLR CABLE CONNECTORS

The revolutionary AX series of XLR connectors introduce an exciting contemporary look and feel to the professional audio interconnect market. They are designed to complement modern audio architecture and truly "fit" within their environment. An impressive list of features guarantees pure sound performance in the most demanding applications providing unrivalled value.

Features

- Unique Australian designed shell and housing.
- One piece ground / latch spring design incorporating twin wipe contacts for a direct connection path from mating shell to ground providing enhanced connection and EMI performance.
- Ergonomic sleeve design for improved grip.
- Channel I.D capability with coloured sleeves.
- Oversized ergonomic latch for quick and easy mating.
- Leading first mate last break pin 1 on socket connectors.
- Chuck style cable clamp to suit 3mm - 8mm (0.118" - 0.314") cable O.D. with integrated split to allow inclusion after soldering.
- Concealed latching point for improved aesthetics, sealing and strength.
- Overmolded boot with flex bend relief for improved aesthetics, cable protection and boot retention.
- Concentric socket contact design provides optimal contact resistance
- Precision machined pin contacts as standard.
- Compact solder buckets to reduce termination time and material wastage during the soldering process.
- Zinc diecast shell housing for robustness and wear with Satin nickel or Black finish.
- Available in 3,4 and 5 contact arrangements.

Options

- Coloured I.D sleeves.
- Satin nickel or Black shell finish.
- Single or Bulk packaging.
- Gold plated contacts.

Ordering Codes

We have listed the more common ordering codes in each section. For further options please refer to the part number breakdown charts. Please contact us if you need any further assistance.

Simple steps to guide you in using this catalogue

- 1) Identify the product group listed in Contents on page 1 and go directly to that page number.
- 2) Each product group cover page then details information and options available.
- 3) Refer to the product detail pages and identify the product you require pictorially.
- 4) Read the product description column for the products standard features.
- 5) Use variations column to determine your choice.
- 6) Identify part number.
- 7) In the event the particular option you require is not listed please refer to the part number breakdown page at the end of each section.
- 8) Please contact us directly if you have any further problems.



Features:

- Unique Australian designed shell and housing.
- Ergonomic stylish sleeve design for improved grip.
- Oversized latch lever preserves your thumb.
- Leading first mate last break pin 1 on socket connectors.
- Chuck style cable clamp to suit 3mm - 8mm (0.118" - 0.314") cable O.D. with integrated split to allow inclusion after soldering.
- Overmolded cable support boot.
- New socket contact design for improved contact resistance.
- Precision machined pin contacts as standard.
- Compact solder buckets to reduce soldering time and wastage.
- Zinc diecast shell housing with Satin nickel or Matt black finish.
- Available in 3,4 and 5 contact arrangements.

Options:

- Coloured I.D sleeves.
- Clear I.D Sleeve for connector marking.
- Satin nickel or Matt black shell finish.
- Single or Bulk packaging.

Part Number Breakdown: page 6

Specifications: page 7

Assembly Instructions: PI538*

PRODUCT - FIGURE	DRAWING Dimensions in mm (inches)	DESCRIPTION	VARIATIONS	PART NUMBER
		XLR 3 pole male Machined contacts Nickel Finish	Standard Gold Plated Contacts Bulk Pack	AX3M AX3M-AU AX3M BULK
		XLR 3 pole male Machined contacts Black Finish	Standard Gold Plated Contacts Bulk Pack	AX3MB AX3MB-AU AX3MB BULK
		XLR 3 pole female Stamped contacts Nickel Finish	Standard Gold Plated Contacts Bulk Pack	AX3F AX3F-AU AX3F BULK
		XLR 3 pole female Stamped contacts Black Finish	Standard Gold Plated Contacts Bulk Pack	AX3FB AX3FB-AU AX3FB BULK
		XLR 4 pole male Machined contacts Nickel Finish	Standard Gold Plated Contacts Bulk Pack	AX4M AX4M-AU AX4M BULK

*PI538 is available for download at www.amphenolaudio.com



PRODUCT - FIGURE	DRAWING Dimensions in mm (inches)	DESCRIPTION	VARIATIONS	PART NUMBER
		XLR 4 pole male Machined contacts Black Finish	Standard	AX4MB
			Gold Plated Contacts	AX4MB-AU
			Bulk Pack	AX4MB BULK
		XLR 4 pole female Machined contacts Nickel Finish	Standard	AX4F
			Gold Plated Contacts	AX4F-AU
			Bulk Pack	AX4F BULK
		XLR 4 pole female Machined contacts Black Finish	Standard	AX4FB
			Gold Plated Contacts	AX4FB-AU
			Bulk Pack	AX4FB BULK
		XLR 5 pole male Machined contacts Nickel Finish	Standard	AX5M
			Gold Plated Contacts	AX5M-AU
			Bulk Pack	AX5M BULK
		XLR 5 pole male Machined contacts Black Finish	Standard	AX5MB
			Gold Plated Contacts	AX5MB-AU
			Bulk Pack	AX5MB BULK
		XLR 5 pole female Machined contacts Nickel Finish	Standard	AX5F
			Gold Plated Contacts	AX5F-AU
			Bulk Pack	AX5F BULK
		XLR 5 pole female Machined contacts Black Finish	Standard	AX5FB
			Gold Plated Contacts	AX5FB-AU
			Bulk Pack	AX5FB BULK



PART NUMBER BREAKDOWN

METAL SHELL TYPE - SOLDER

E. G. **AX3MB2-AU BULK**
AX (Series Prefix), **3** contacts, **M**ale, **B**lack Finish,
2 (Red Sleeve)- **AU** (Gold Plated Contacts), **BULK** Packaged.

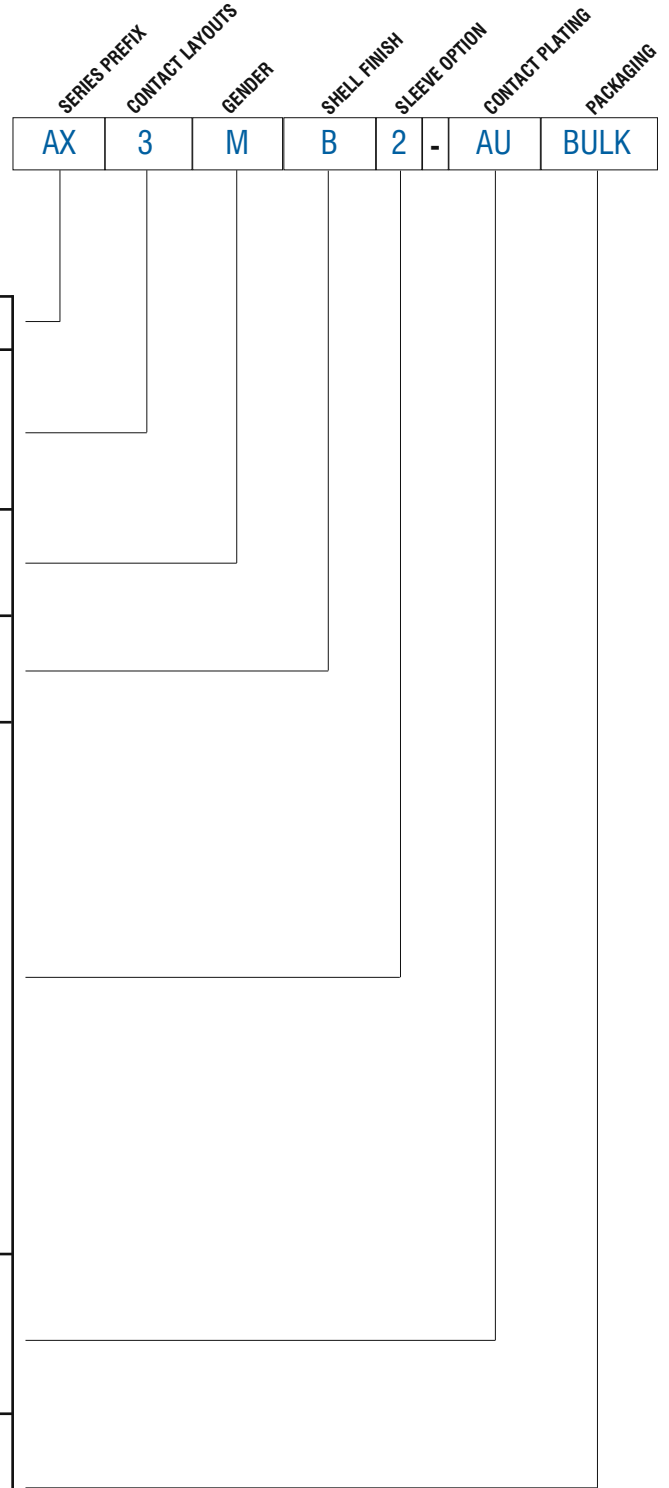

SERIES PREFIX	AX	=	Series Prefix
CONTACT LAYOUTS	3	=	3 Contacts
	4	=	4 Contacts
	5	=	5 Contacts
GENDER	F	=	Female Socket Contacts
	M	=	Male Pin Contacts
SHELL FINISH	Blank	=	Nickel Plated Finish
	B	=	Black Finish
SLEEVE OPTION	1	=	Brown
	2	=	Red
	3	=	Orange
	4	=	Yellow
	5	=	Green
	6	=	Blue
	7	=	Violet
	8	=	Grey
	9	=	White
	C	=	Clear
CONTACT PLATING	Blank	=	Standard Plating (Silver or Tin - Refer to Standard Data.)
	AU	=	Gold Plated
PACKAGING	Blank	=	Individual Bags
	BULK	=	Bulk Packed

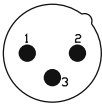
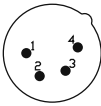
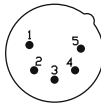

STANDARD DATA AX SERIES CABLE CONNECTORS

		VALUE		
GENERAL CHARACTERISTICS	Number of contacts	3	4	5
	AX Series Contact Arrangements (Front view of pin inserts)			
	Termination	SOLDER		
	Max. Wire Gauge - Stranded wire: Solder	14AWG	16AWG	18AWG
	Flammability rating of insulator plastics and housings	UL94V-0		
	Environmental	Complies with EU RoHS 2 Directive 2011/65/EU		
ELECTRICAL CHARACTERISTICS	Service Voltage RMS	133V ¹⁾		
	Test Voltage AC RMS	1400V		
	Current carrying capacity: Solder	15A	10A	7.5A
	Typical Contact Resistance	≤3m Ω		
	Insulation Resistance	≥1G Ω		
CLIMATIC CHARACTERISTICS	Protection Class	IP40		
	Operating Temperature	-25 °C to +75 °C (-13°F to +167°F)		
MECHANICAL CHARACTERISTICS	Insertion and Withdrawal force	≥10N - ≤30N		
	Weight ²⁾	31g (0.068lb)	33g (0.073lb)	33g (0.073lb)
	Typical Cable retention force	22Kg to 44Kg (50lb to 100lb) - Dependent on cable material and diameter.		
	Cable O.D. range	3mm to 8mm (0.118" to 0.314")		
	Mechanical Operations	1000 mating cycles		
MATERIALS	Connector shell - Metal Shell finish	Diecast Zinc Alloy Satin nickel or Black		
	Insulators	UL94V-0 PA66, 30% Glass Filled		
	Boot / Backshell Finish	UL94V-0 Noryl N190 / Santoprene Black, other colours available - see page 80		
	Cable clamp	Noryl N190		
	Sleeve	Noryl N190		
	Male Contact Machined - Solder / Plating	Brass / Silver or Gold (Optional)		
	Female Contact Stamped - Solder / Plating	Phosphor Bronze / Tin or Gold (Optional)		

Rev 3 - 03/2013

¹⁾ Not suitable for domestic applications above 50V

²⁾ Approximate weight only, does not include packaging. Please contact us for exact weight for shipping purposes.

Amphenol

ISO VIEW OF AC3MM

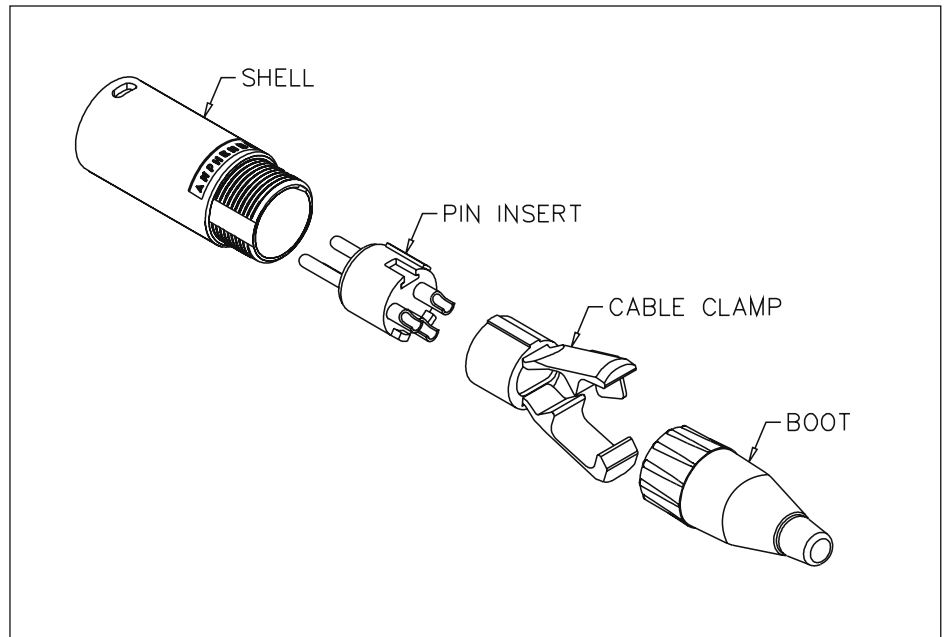

ISO VIEW OF AC3FI

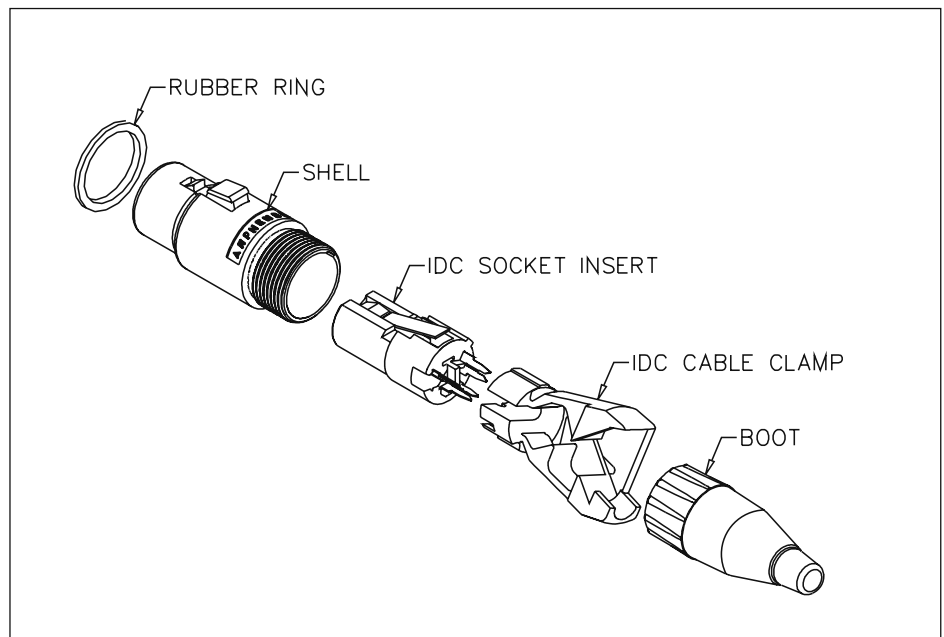

AMPHENOL AUSTRALIA WEBSITE

www.amphenolaudio.com

AMPHENOL WORLD HEADQUARTERS WEBSITE

www.amphenol.com

Amphenol



AC SERIES XLR CABLE CONNECTORS



Amphenol Australia have been manufacturing and designing innovative XLR connectors since 1955 and were the first to offer the cost saving Insulation Displacement Contact (IDC) in an XLR connector. The IDC connector is ideal for Original Equipment Manufacturers and end users alike and offers an alternative to our standard solder connector. The AC series cable connector range complies with IEC268-12 and AES 14-1992 standards. CSA File Number 68598.

Features

- AC series XLR connectors feature the unique Australian design and patented "Jaws" cable retention system for both standard Solder connectors and the Insulation Displacement Contact (IDC) connectors.
- A leading first mate last break socket contact is standard on all female connectors (Pin 1).
- The "Jaws" cable retention system provides up to 44kg (100lb) of strain.
- Solderless IDC technology offers savings of up to 60% in termination time.
- The AC series connector can be quickly and easily assembled without screws – by hand or portable termination tool. (Part number T2860)
- Available in 3, 4, 5, 6A and 7 contact arrangements.
- Compatible with all other XLR brands.

Options

- Solder Bucket termination
- Insulation Displacement Contact (IDC)
- Thermoplastic shell
- Zinc Diecast shell - Satin Nickel Finish
- Zinc Diecast shell - Black Polyester Finish
- Gold, Silver or Tin Plated contacts
- Bulk Style Packaging
- Single Bag packs
- Precision machined contacts
- Cost effective stamped contacts on 3 pole

Options (Cont'd)

- Standard Jaws cable clamp, Cable O.D 3mm to 6.5mm (0.118" to 0.255")
- Large Jaws cable clamp, Cable O.D 6.5mm to 8mm (0.255" to 0.314")
- IDC Jaws cable clamp, Max. Cable O.D 5.85mm (0.23")
- Metal Boots / Backshells
- Coloured Boots / Backshells
- Coloured Identification rings
- Termination / Assembly tooling

Jaws Cable Clamp Options



Standard Jaws cable clamp (Black), Cable O.D 3mm to 6.5mm (0.118" to 0.255")



Large Jaws cable clamp (Purple), Cable O.D 6.5mm to 8mm (0.255" to 0.314")

Ordering Codes

We have listed the more common ordering codes in each section. For further options please refer to the part number breakdown charts. Please contact us if you need any further assistance.

Simple steps to guide you in using this catalogue

- 1) Identify the product group listed in Contents on page 1 and go directly to that page number.
- 2) Each product group cover page then details information and options available.
- 3) Refer to the product detail pages and identify the product you require pictorially.
- 4) Read the product description column for the products standard features.
- 5) Use variations column to determine your choice.
- 6) Identify part number.
- 7) In the event the particular option you require is not listed please refer to the part number breakdown page at the end of each section.
- 8) Please contact us directly if you have any further problems.

Amphenol











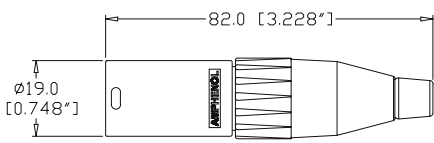

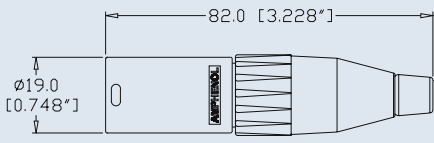
Features:

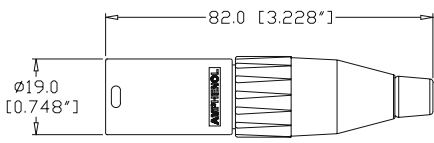
- Zinc Diecast Shell.
- Solder Bucket connections.
- "Jaws" Cable Retention System.
- Contact layouts in 3, 4, 5, 6A and 7.
- Precision machined or Stamped contacts.
- Leading first mate last break socket contact.
- Quick and easy assembly without screws – by hand or portable termination tool. (Part number T2860.)

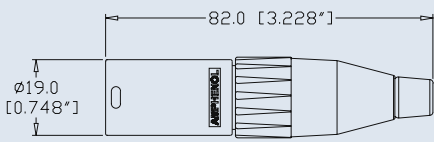

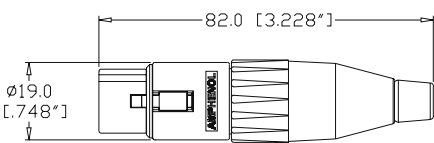

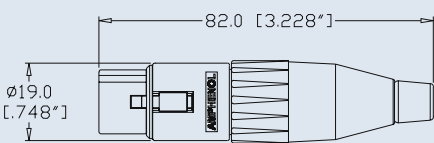





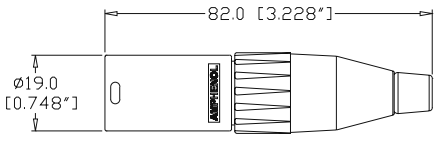

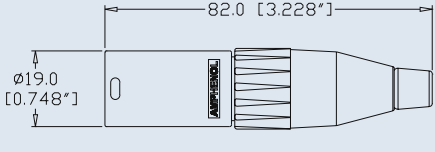

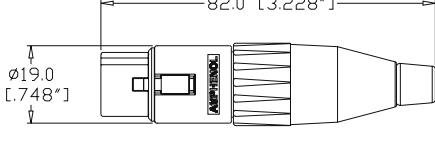
Options: Stamped Contacts (3 contact only), Gold plated contacts, Large or Small Jaws Cable Clamp, Black Finish Shell, Bulk Pack, Coloured Boots / Backshells

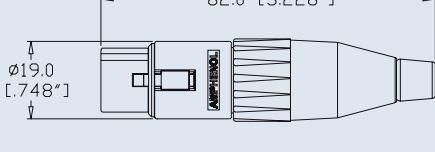
Part Number Breakdown: [page 13](#)

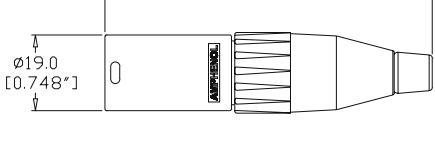
Specifications: [page 20](#)

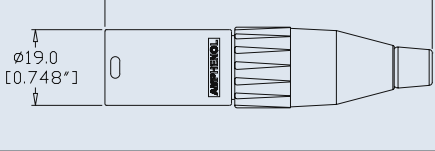

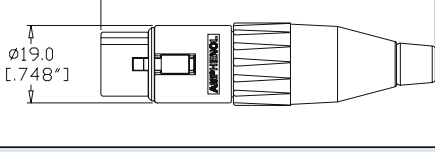

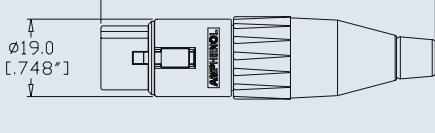







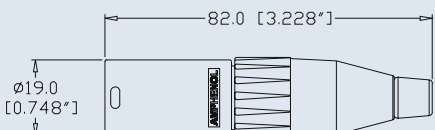

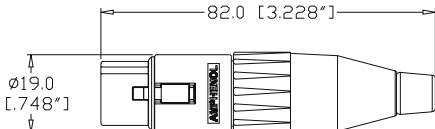
PRODUCT - FIGURE	DRAWING	DESCRIPTION	VARIATIONS	PART NUMBER
		XLR 3 pole male, Machined contacts, Nickel Finish, Jaws cable clamp	Standard Gold Plated Contacts Large Cable Clamp Bulk Pack	AC3MM AC3MM-AU AC3MMJ AC3MM BULK
		XLR 3 pole male, Machined contacts, Black Finish, Jaws cable clamp	Standard Gold Plated Contacts Large Cable Clamp Bulk Pack	AC3MMB AC3MMB-AU AC3MMBJ AC3MMB BULK
		XLR 3 pole male, Stamped contacts, Nickel Finish, Jaws cable clamp	Standard Gold Plated Contacts Large Cable Clamp Bulk Pack	AC3M AC3M-AU AC3MJ AC3M BULK
		XLR 3 pole male, Stamped contacts, Black Finish, Jaws cable clamp	Standard Gold Plated Contacts Large Cable Clamp Bulk Pack	AC3MB AC3MB-AU AC3MBJ AC3MB BULK
		XLR 3 pole female, Stamped contacts, Nickel Finish, Jaws cable clamp	Standard Gold Plated Contacts Large Cable Clamp Bulk Pack	AC3F AC3F-AU AC3FJ AC3F BULK
		XLR 3 pole female, Stamped contacts, Black Finish, Jaws cable clamp	Standard Gold Plated Contacts Large Cable Clamp Bulk Pack	AC3FB AC3FB-AU AC3FBJ AC3FB BULK

Amphenol

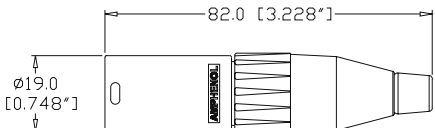
PRODUCT - FIGURE	DRAWING Dimensions in mm (inches)	DESCRIPTION	VARIATIONS	PART NUMBER
		XLR 4 pole male, Machined contacts, Nickel Finish, Jaws cable clamp	Standard	AC4M
			Gold Plated Contacts	AC4M-AU
			Large Cable Clamp	AC4MJ
			Bulk Pack	AC4M BULK
		XLR 4 pole male, Machined contacts, Black Finish, Jaws cable clamp	Standard	AC4MB
			Gold Plated Contacts	AC4MB-AU
			Large Cable Clamp	AC4MBJ
			Bulk Pack	AC4MB BULK
		XLR 4 pole female, Machined contacts, Nickel Finish, Jaws cable clamp	Standard	AC4F
			Gold Plated Contacts	AC4F-AU
			Large Cable Clamp	AC4FJ
			Bulk Pack	AC4F BULK
		XLR 4 pole female, Machined contacts, Black Finish, Jaws cable clamp	Standard	AC4FB
			Gold Plated Contacts	AC4FB-AU
			Large Cable Clamp	AC4FBJ
			Bulk Pack	AC4FB BULK
		XLR 5 pole male, Machined contacts, Nickel Finish, Jaws cable clamp	Standard	AC5M
			Gold Plated Contacts	AC5M-AU
			Large Cable Clamp	AC5MJ
			Bulk Pack	AC5M BULK
		XLR 5 pole male, Machined contacts, Black Finish, Jaws cable clamp	Standard	AC5MB
			Gold Plated Contacts	AC5MB-AU
			Large Cable Clamp	AC5MBJ
			Bulk Pack	AC5MB BULK
		XLR 5 pole female, Machined contacts, Nickel Finish, Jaws cable clamp	Standard	AC5F
			Gold Plated Contacts	AC5F-AU
			Large Cable Clamp	AC5FJ
			Bulk Pack	AC5F BULK
		XLR 5 pole female, Machined contacts, Black Finish, Jaws cable clamp	Standard	AC5FB
			Gold Plated Contacts	AC5FB-AU
			Large Cable Clamp	AC5FBJ
			Bulk Pack	AC5FB BULK

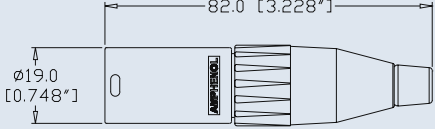

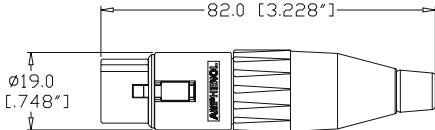
Amphenol

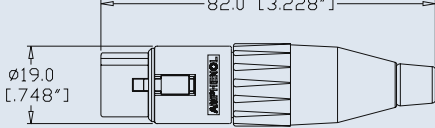
PRODUCT - FIGURE	DRAWING Dimensions in mm (inches)	DESCRIPTION	VARIATIONS	PART NUMBER
		XLR 6A pole male, Machined contacts, Nickel Finish, Jaws cable clamp	Standard	AC6AM
			Gold Plated Contacts	AC6AM-AU
			Large Cable Clamp	AC6AMJ
			Bulk Pack	AC6AM BULK
		XLR 6A pole male, Machined contacts, Black Finish, Jaws cable clamp	Standard	AC6AMB
			Gold Plated Contacts	AC6AMB-AU
			Large Cable Clamp	AC6AMBJ
			Bulk Pack	AC6AMB BULK
		XLR 6A pole female, Machined contacts, Nickel Finish, Jaws cable clamp	Standard	AC6AF
			Gold Plated Contacts	AC6AF-AU
			Large Cable Clamp	AC6AFJ
			Bulk Pack	AC6AF BULK
		XLR 6A pole female, Machined contacts, Black Finish, Jaws cable clamp	Standard	AC6AFB
			Gold Plated Contacts	AC6AFB-AU
			Large Cable Clamp	AC6AFBJ
			Bulk Pack	AC6AFB BULK
		XLR 7 pole male, Gold plated Machined contacts, Nickel Finish, Jaws cable clamp	Standard	AC7M
			Large Cable Clamp	AC7MJ
			Bulk Pack	AC7M BULK
		XLR 7 pole male, Gold plated Machined contacts, Black Finish, Jaws cable clamp	Standard	AC7MB
			Large Cable Clamp	AC7MBJ
			Bulk Pack	AC7MB BULK
		XLR 7 pole female, Gold plated Machined contacts, Nickel Finish, Jaws cable clamp	Standard	AC7F
			Large Cable Clamp	AC7FJ
			Bulk Pack	AC7F BULK
		XLR 7 pole female, Gold plated Machined contacts, Black Finish, Jaws cable clamp	Standard	AC7FB
			Large Cable Clamp	AC7FBJ
			Bulk Pack	AC7FB BULK

Amphenol

PART NUMBER BREAKDOWN

METAL SHELL TYPE - SOLDER



E. G. **AC3MMBJ-AU BULK**
AC (Series Prefix), **3** contacts, **Male**, **M** Machined Contacts, **Black** Polyester Finish,
J (Large Jaws), - **AU** (Gold Plated Contacts), **Bulk** Packaged.

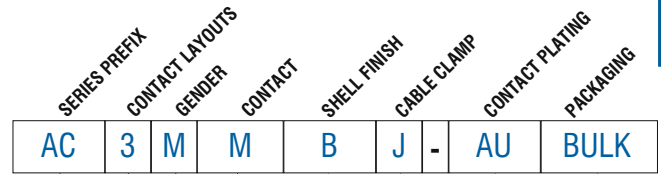

SERIES PREFIX	AC	=	Series Prefix
CONTACT LAYOUTS	3	=	3 Contacts
	4	=	4 Contacts
	5	=	5 Contacts
	6A	=	6 Contacts
	7	=	7 Contacts
GENDER	F	=	Female Socket Contacts
	M	=	Male Pin Contacts
CONTACT¹	Blank	=	Stamped Contacts
	M	=	Machined Contacts
	G	=	Stamped Contacts, Ground Tag
	MG	=	Machined Contacts, Ground Tag (Applicable 3 male pin contacts, option M and MG only)
SHELL FINISH²	Blank	=	Nickel Plated Finish
	B	=	Black Polyester Finish
CABLE CLAMP	Blank	=	Standard Jaws 3 mm - 6.5 mm cable O.D. (0.118" to 0.255")
	J	=	Large Jaws 6.5mm - 8mm cable O.D. (0.255" to 0.314")
CONTACT PLATING³	Blank	=	Standard Plating (Silver or Tin - Refer to Standard Data.)
	AU	=	Gold Plated
PACKAGING	Blank	=	Individual Bags
	BULK	=	Bulk Packed

Note:

¹ 4 - 7 contact connectors have machined contacts and grounding as standard.

² Ground contacts are not supplied with the black polyester finish shell option.

³ 7 Contact is gold plated as standard.

⁴ All AC Series Connectors are available with optional colour coded boot / backshell. Refer to page 137 and simply add colour to end of part number. Example: AC3MM - RED





Features:

- Thermoplastic Shell.
- Solder Bucket Connections.
- “Jaws” Cable Retention System.
- Stamped or Machined Contacts.
- Leading first mate last break socket contact.
- Quick and easy assembly without screws – by hand or portable termination tool. (Part number T2860.)

Options: Gold Plated Contacts, Stamped Contacts (3 Contact only), Bulk Pack, Coloured Boots / Backshells
3, 4, 5, 6A and 7 Contacts.

Specifications: page 20

PRODUCT - FIGURE	DRAWING	DESCRIPTION	VARIATIONS	PART NUMBER
		XLR 3 pole male, Machined contacts, Thermoplastic shell, Jaws cable clamp	Standard	AC3MMCP
			Gold Plated Contacts	AC3MMCP-AU
			Large Cable Clamp	AC3MMCPJ
			Bulk Pack	AC3MMCP BULK
		XLR 3 pole male, Stamped contacts, Thermoplastic shell, Jaws cable clamp	Standard	AC3MCP
			Gold Plated Contacts	AC3MCP-AU
			Large Cable Clamp	AC3MCPJ
			Bulk Pack	AC3MCP BULK
		XLR 3 pole female, Stamped contacts, Thermoplastic shell, Jaws cable clamp	Standard	AC3FCP
			Gold Plated Contacts	AC3FCP-AU
			Large Cable Clamp	AC3FCPJ
			Bulk Pack	AC3FCP BULK

Note: Thermoplastic shell connectors are also available in 4 - 7 contact arrangements, please contact us for ordering code.

ISO VIEW OF AC3MM

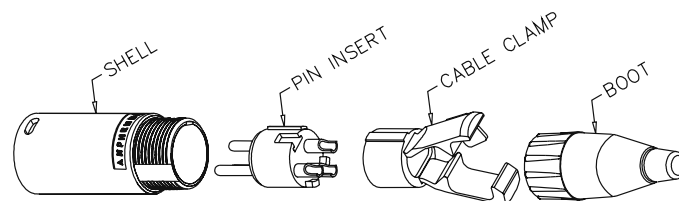

METAL SHELL TYPE RIGHT ANGLE - SOLDER



Features:

- XLR 90° right angle
- Metal or Thermoplastic connector shell
- Thermoplastic 90° right angle backshell
- Solder bucket connections
- "Jaws"™ Cable Retention System
- Contact Layouts in 3, 4, 5, 6A and 7
- Precision machined pin contacts
- Leading first mate last break socket contact

Specifications: [page 20](#)

Assembly Tooling: [page 137](#)

NOTE* Connector assembly requires the use of assembly tool T2880. Please refer to assembly instruction PI540* for details. The connector is non-servicable once assembled.



PRODUCT - FIGURE	DRAWING	DESCRIPTION	VARIATIONS	PART NUMBER
		XLR 90° right angle female, Metal shell, Nickel Finish, Jaws cable clamp	3 pole	AC3FR
			4 pole	AC4FR
			5 pole	AC5FR
			6A pole	AC6AFR
			7 pole	AC7FR
		XLR 90° right angle male, Metal shell, Nickel Finish, Jaws cable clamp	3 pole	AC3MMR
			4 pole	AC4MR
			5 pole	AC5MR
			6A pole	AC6AMR
			7 pole	AC7MR

*PI540 is available for download at www.amphenolaudio.com

**METAL SHELL TYPE - IDC
(SOLDERLESS)**

Amphenol



The Insulation Displacement Contact (IDC) connector is ideal for Original Equipment Manufacturers and end users alike and offers an alternative to our standard solder connector. Connectors can be quickly and easily assembled without screws or a soldering iron – by hand or portable termination tool. (Part number T2860.)

Labour savings of up to 60% in termination time can be achieved.

Recommended Cable Dimensions: page 21





Features:

- Zinc Diecast Shell
- Available in 3 Contact only.
- Insulation Displacement Contacts (IDC - Solderless).
- “Jaws” Cable Retention System.
- Leading first mate last break socket contact.

Options: Gold plated contacts, Black Finish Shell, Bulk Pack, Coloured Boots / Backshells.

Specifications: page 20

Assembly Instructions: page 19

PRODUCT - FIGURE	DRAWING	DESCRIPTION	VARIATIONS	PART NUMBER
		XLR 3 pole male, IDC contacts, Nickel Finish, IDC Jaws cable clamp	Standard	AC3MI
			Gold Plated Contacts	AC3MI-AU
			Bulk Pack	AC3MI BULK
		XLR 3 pole male, IDC contacts, Black Finish, IDC Jaws cable clamp	Standard	AC3MIB
			Gold Plated Contacts	AC3MIB-AU
			Bulk Pack	AC3MIB BULK
		XLR 3 pole female, IDC contacts, Nickel Finish, IDC Jaws cable clamp	Standard	AC3FI
			Gold Plated Contacts	AC3FI-AU
			Bulk Pack	AC3FI BULK
		XLR 3 pole female, IDC contacts, Black Finish, IDC Jaws cable clamp	Standard	AC3FIB
			Gold Plated Contacts	AC3FIB-AU
			Bulk Pack	AC3FIB BULK

Note: Amphenol can not guarantee the termination performance unless the recommended cable dimensions listed on page 21 are followed.

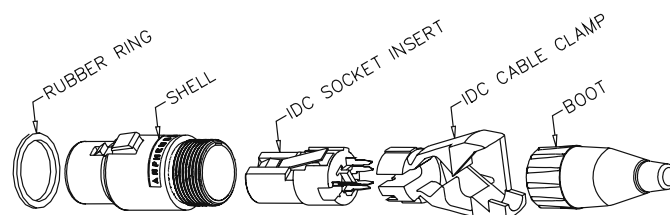
ISO VIEW OF AC3FI



Amphenol

PART NUMBER BREAKDOWN

METAL SHELL TYPE - IDC



E. G . **AC3MIB-AU BULK**
AC (Series Prefix), **3** contacts, **M**ale, IDC Contacts, **B**lack Polyester Finish,
- **AU** (Gold Plated Contacts), **BULK** Packaged.

SERIES PREFIX	AC	=	Series Prefix
CONTACT LAYOUT	3	=	3 Contact only
GENDER	F	=	Female Socket Contacts
	M	=	Male Pin Contacts
TERMINATION METHOD	I	=	IDC Contacts
SHELL FINISH	Blank	=	Nickel Plated Finish
	B	=	Black Polyester Finish
CONTACT PLATING	Blank	=	Standard Plating (Silver or Tin - Refer to Standard Data.)
	AU	=	Gold Plated
PACKAGING	Blank	=	Individual Bags
	BULK	=	Bulk Packed

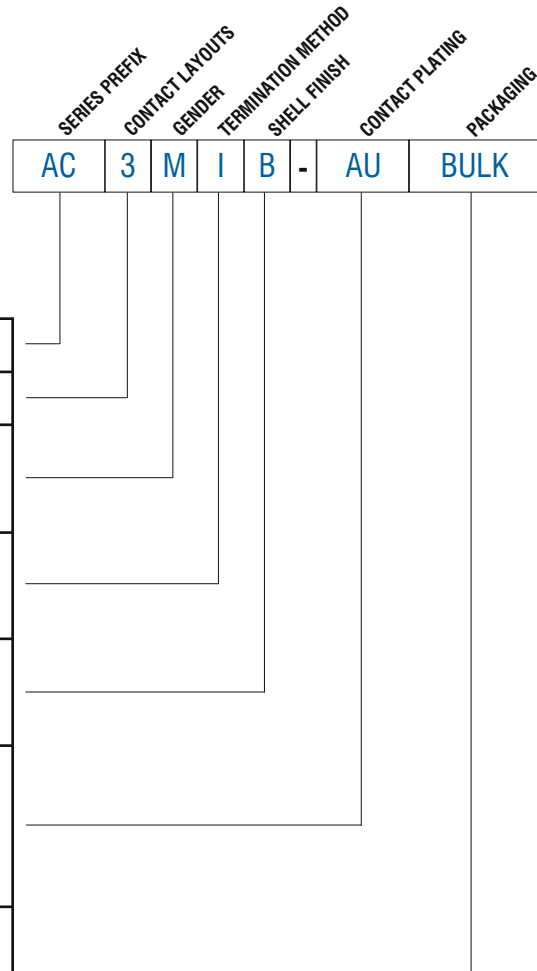

Note: All AC Series Connectors are available with optional colour coded boot / backshell. Refer to page 80 and simply add colour to end of part number. Example: AC3MI - RED

THERMOPLASTIC SHELL TYPE - IDC (SOLDERLESS)



The Insulation Displacement Contact (IDC) connector is ideal for Original Equipment Manufacturers and end users alike and offers an alternative to our standard solder connector. Connectors can be quickly and easily assembled without screws or a soldering iron – by hand or portable termination tool. Labour savings of up to 60% in termination time can be achieved.

Recommended Cable Dimensions: page 21

Features:

- Thermoplastic Shell
- Available 3 Contact only.
- Insulation Displacement Contacts (IDC - Solderless).
- "Jaws" Cable Retention System.
- Leading first mate last break socket contact.
- Quick and easy assembly without screws – by hand or portable termination tool. (Part number T2860.)

Options: Gold plated contacts, Bulk Pack, Coloured Boots / Backshells
Specifications: page 20

PRODUCT - FIGURE	DRAWING	DESCRIPTION	VARIATIONS	PART NUMBER
		XLR 3 pole male, IDC contacts, Thermoplastic shell, IDC Jaws cable clamp	Standard Gold Plated Contacts Bulk Pack	AC3MCPI AC3MCPI-AU AC3MCPI BULK
		XLR 3 pole female, IDC contacts, Thermoplastic shell, IDC Jaws cable clamp	Standard Gold Plated Contacts Bulk Pack	AC3FCPI AC3FCPI-AU AC3FCPI BULK

Note: Amphenol can not guarantee the termination performance unless the recommended cable dimensions listed on page 21 are followed.

PART NUMBER BREAKDOWN

IDC THERMOPLASTIC SHELL TYPE

E. G. **AC3MCPI-AU BULK**
 AC (Series Prefix), 3 contacts, Male, CP (Thermoplastic Shell), IDC Contacts, - AU (Gold Plated Contacts), Bulk Packaged.

SERIES PREFIX	AC	=	Series Prefix
CONTACT LAYOUT	3	=	3 Contacts only
GENDER	F	=	Female Socket Contacts
	M	=	Male Pin Contacts
SHELL MATERIAL	CP	=	Thermoplastic Shell
TERMINATION METHOD	I	=	IDC Contacts
CONTACT PLATING	Blank	=	Standard Plating (Silver or Tin - Refer to Standard Data.)
	AU	=	Gold Plated
PACKAGING	Blank	=	Individual Bags
	BULK	=	Bulk Packed

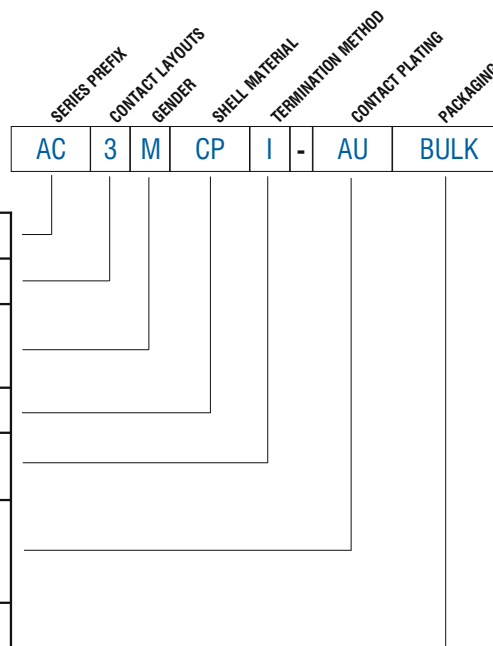

Note: All AC Series Connectors are available with optional colour coded boot / backshell. Refer to page 80 and simply add colour to end of part number. Example: AC3MCPI - RED

AC IDC SERIES CABLE ASSEMBLY INSTRUCTIONS

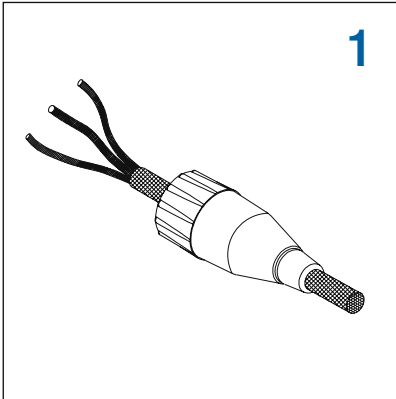

1

Push the cable through the boot assembly and strip the cable back 35 to 40 mm. Twist the shield wire.

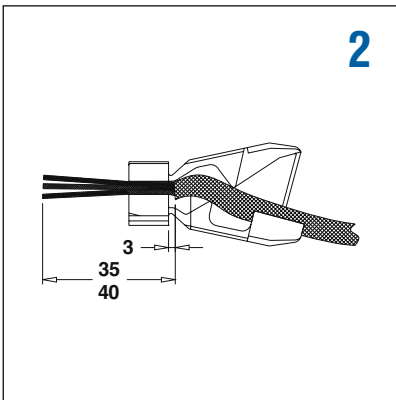

2

Fit the cable into the 'Jaws' cable clamp ensuring that the cable is pushed up to the neck of the clamp within 3mm.

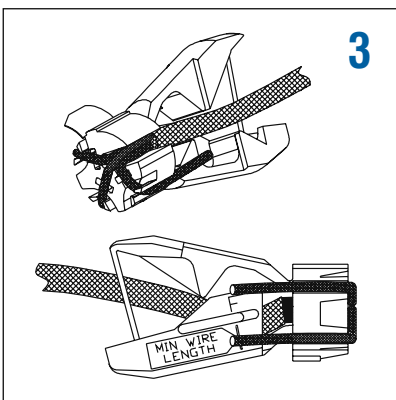

3

Pull back the conductors into their individual wire guidetracks. Note: Two spring fingers in the clamp will hold the conductors in position during subsequent operations. The ends of the two insulated wires must be on or past the minimum wire length mark.

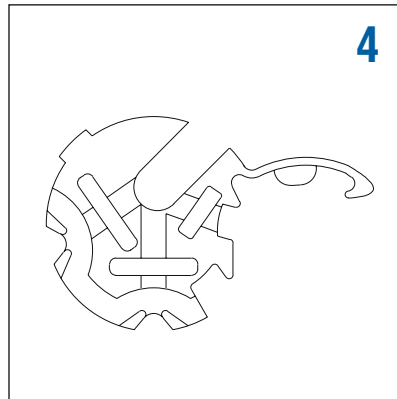

4

For ground protection the twisted shield wire is clipped in place with the ground protect flap.

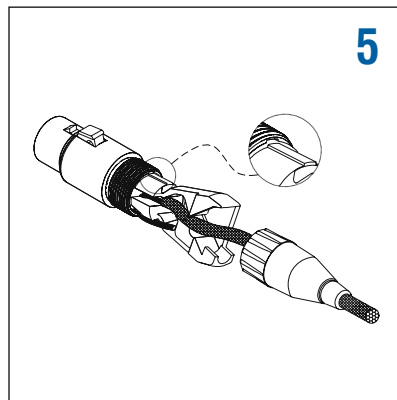

5

Trim back the shield wire, so there are no wires coming out of the flap and fit the 'Jaws' cable clamp into the shell assembly, ensuring the keyways are aligned.

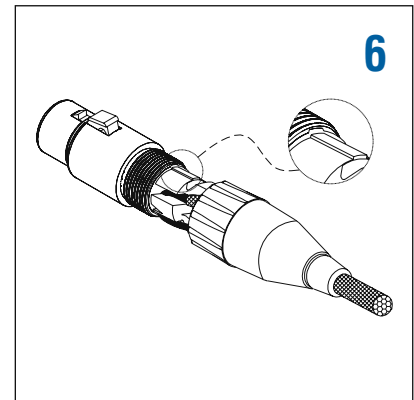

6

Close the cable clamp slightly and push the boot over the clamp ensuring the wires fit inside the boot.

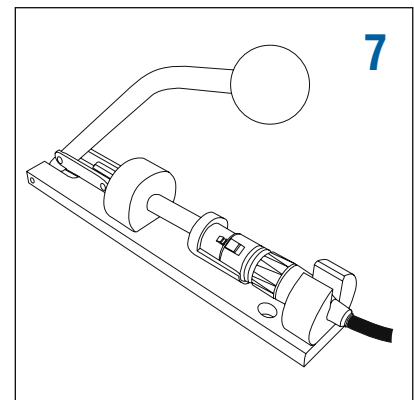

7

Final assembly can be achieved either by manually screwing the boot on, or by using an Amphenol Australia T2860 termination tool.

Amphenol

STANDARD DATA AC CABLE CONNECTORS

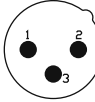
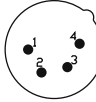
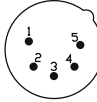
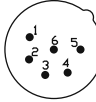
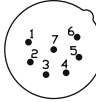
		VALUE				
GENERAL CHARACTERISTICS	Number of contacts	3	4	5	6A	7
	AC Series Contact Arrangements (Front view of pin inserts)					
	Termination	IDC / SOLDER	SOLDER	SOLDER	SOLDER	SOLDER
	Max. Wire Gauge - Stranded wire:					
	IDC	24AWG	N/A	N/A	N/A	N/A
	Solder	14AWG	16AWG	18AWG	18AWG	20AWG
	Flammability rating of insulator plastics and housings	UL94V-0				
Environmental	Complies with EU RoHS 2 Directive 2011/65/EU					
ELECTRICAL CHARACTERISTICS	Service Voltage RMS	133V ¹⁾				
	Test Voltage AC RMS	1400V				
	Current carrying capacity:					
	IDC	1A	N/A	N/A	N/A	N/A
	Solder	15A	10A	7.5A	7.5A	5A
	Typical Contact Resistance	≤3mΩ				
Insulation Resistance	≥1GΩ					
CLIMATIC CHARACTERISTICS	Protection Class	IP40				
	Operating Temperature	-25°C to +75°C (-13°F to +167°F)				
MECHANICAL CHARACTERISTICS	Insertion and Withdrawal force	≥10N - ≤30N				
	Weight - Metal ²⁾	36g (0.080lb)	37g (0.081lb)	38g (0.083lb)	38g (0.083lb)	38g (0.083lb)
	Weight - Thermoplastic ²⁾	18g (0.039lb)	19g (0.041lb)	20g (0.044lb)	20g (0.044lb)	20g (0.044lb)
	Typical Cable retention force	22Kg to 44Kg (50lb to 100lb) - Dependent on cable material and diameter.				
	Cable O.D. range - JAWS clamp					
	IDC	Max. Cable O.D. 5.85mm (0.23")				
	Standard solder	3mm to 6.5mm (0.118" to 0.255")				
	Large Solder	6.5mm to 8mm (0.255" to 0.314")				
Mechanical Operations	1000 mating cycles					

Rev 5 - 03/2013

¹⁾ Not suitable for domestic applications above 50V

²⁾ Approximate weight only, does not include packaging. Please contact us for exact weight for shipping purposes.

Amphenol

STANDARD DATA AC CABLE CONNECTORS

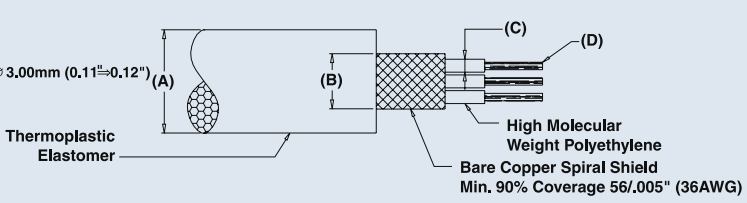
		DETAILS
MATERIALS	Connector shell - Metal	Diecast Zinc Alloy
	Shell finish	Satin nickel or Black polyester
	Connector shell - Thermoplastic	Thermoplastic, UL94V-0 Modified PPE Resin
	Shell finish	Black
	Insulators	UL94V-0 PBT Resin or Modified PPE Resin
	Boot / Backshell	UL94V-0 Modified PPE Resin or Machined Brass
	Finish	Black, other colours available - see page 80
	Cable clamp	
	IDC Socket JAWS	UL94V-0 Modified PPO Resin (Pink)
	IDC Pin JAWS	UL94V-0 Modified PPO Resin (Blue)
	Standard Solder JAWS	UL94V-0 Modified PPO Resin (Black)
	Large Solder JAWS	UL94V-0 Modified PPO Resin (Purple)
	Cable Bushing	Santoprene
	Male Contact	Thermoplastic Polyurethane
	Stamped - IDC / Plating	Phosphor Bronze / Silver or Gold (Optional)
	Stamped - Solder / Plating	Phosphor Bronze / Silver or Gold (Optional)
Machined - Solder / Plating	Brass / Silver or Gold (Optional)	
Female Contact		
Stamped - IDC / Plating	Phosphor Bronze / Tin or Gold (Optional)	
Stamped - Solder / Plating	Phosphor Bronze / Tin or Gold (Optional)	
Machined - Solder / Plating	Brass / Silver or Gold (Optional)	
IDC RECOMMENDED CABLE DIMENSIONS	 <p> A - Cable O.D.: Max. \varnothing 5.85mm (0.23"). B - Bare Copper Spiral Shield OD \varnothing 2.75 \Rightarrow \varnothing 3.00mm (0.11" \Rightarrow 0.12") C - OD \varnothing 1.30 \Rightarrow \varnothing 1.50mm (0.05" \Rightarrow 0.06") D - 16/.005" (24 AWG stranded wire) </p> <p> Thermoplastic Elastomer High Molecular Weight Polyethylene Bare Copper Spiral Shield Min. 90% Coverage 56/.005" (36AWG) </p>	



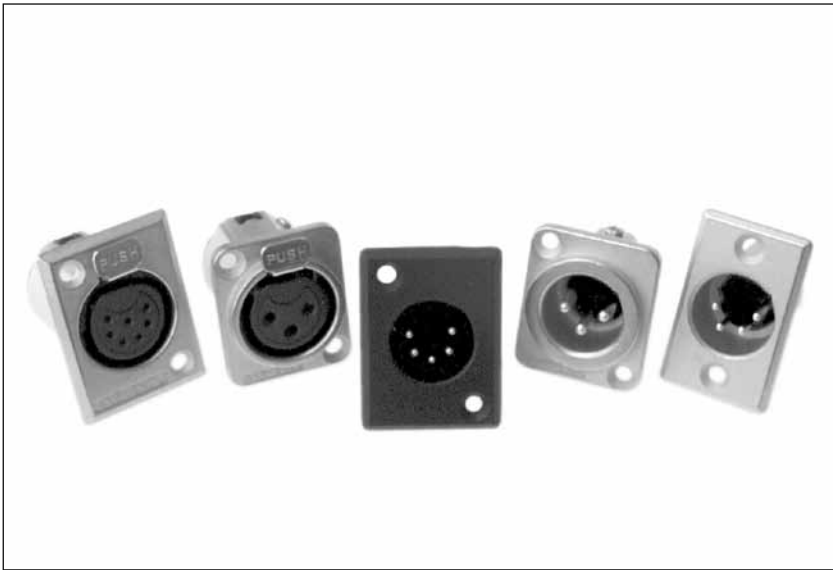

AC “Z” SERIES XLR METAL CHASSIS MOUNT CONNECTORS

The metal chassis mount “Z” series connectors are designed for the audio user where durability, reliability and strength across a wide range of applications are important. All AC products are manufactured to the highest quality standards and will withstand the harshest environments. This range complies with IEC268-12 and AES 14-1992 standards. CSA File Number 68598

Features

- The “D” size housing can be either front or rear mounted using the same panel cutout.
- The “P” size housing is the original wide flange front mounting XLR connector. “PN” is the original narrow flange front mounting male connector.
- A leading first mate last break socket contact is standard on all female connectors (Pin 1).
- Solder cup or Vertical PCB versions.
- Connectors are fitted with a grounding system for RFI shielding applications.
- Available in 3, 4, 5, 6A and 7 contact arrangements.
- Compatible with all other XLR brands.

Options

- Solder Bucket termination
- Vertical PCB contacts
- Zinc Diecast Shell - Satin Nickel Finish
- Zinc Diecast Shell - Black Polyester Finish
- Gold, Silver or Tin Plated Contacts
- Bulk Packaging
- Single Bag packs
- Precision machined contacts
- Cost effective stamped contacts on 3 pole
- Latchless versions (Non-Latching) (Female only)

Note: A ground tag is standard on all AC “Z” series connectors. Although the ground tag is intended for RFI shielding applications, Amphenol cannot guarantee its effectiveness in all cases.

The non-conductive Black polyester finish insulates the ground tag from the shell and should not be used in applications requiring ground contact to the shell.

Ordering Codes

We have listed the more common ordering codes in each section. For further options please refer to the part number breakdown charts. Please contact us if you need any further assistance.

Simple steps to guide you in using this catalogue

- 1) Identify the product group listed in Contents on page 1 and go directly to that page number.
- 2) Each product group cover page then details information and options available.
- 3) Refer to the product detail pages and identify the product you require pictorially.
- 4) Read the product description column for the products standard features.
- 5) Use variations column to determine your choice.
- 6) Identify part number.
- 7) In the event the particular option you require is not listed please refer to the part number breakdown page at the end of each section.
- 8) Please contact us directly if you have any further problems.

METAL D TYPE FLANGE - SOLDER AND PCB



Features:

- Zinc Diecast Shell.
- D size housing can be front or rear mounted using the same panel cutout.
- Solder Bucket connections.
- Vertical PCB mounting (not available in 4 contact female).
- Precision machined or Stamped contacts (3 pin only).
- Leading first mate last break socket contact.
- Positive latch lock system.

Options: Stamped contacts (3 contact only), Gold plated contacts, Vertical PCB contacts, Black finish, Non-Latching (Female only), Bulk Pack.

Part Number Breakdown: [page 31](#)











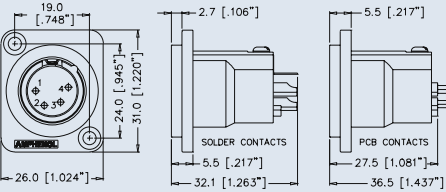

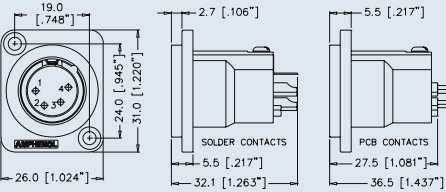

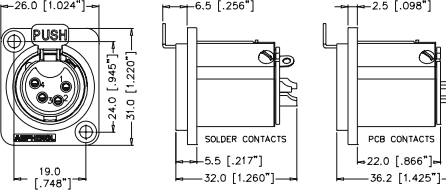
Specifications: [page 32](#)

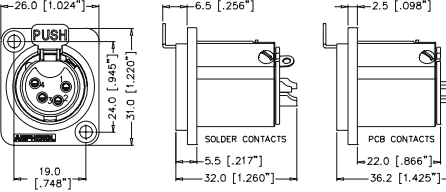

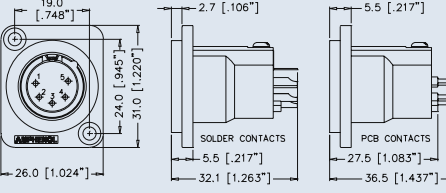

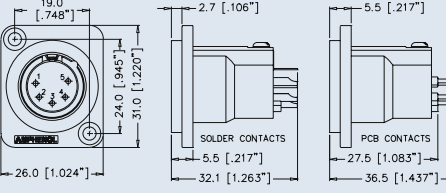

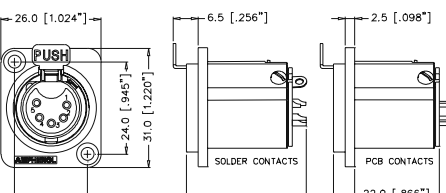

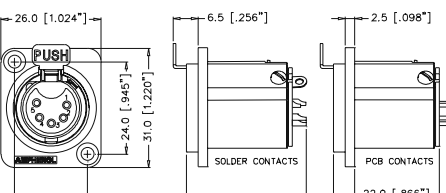

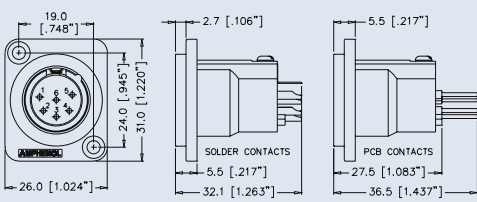

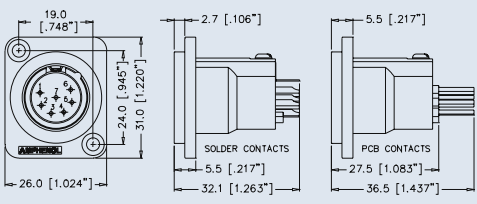

PCB Footprints: [page 33](#)

Panel Cutouts: [page 33](#)

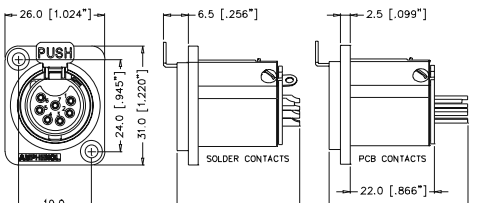

PRODUCT - FIGURE	DRAWING	Dimensions in mm (inches)	DESCRIPTION	VARIATIONS	PART NUMBER
		<p>SOLDER CONTACTS: 2.7 [.106\"/> </p>	XLR 3 pole male, D Flange, Machined contacts, Nickel Finish	Standard	AC3MMDZ
			Gold Plated Contacts	AC3MMDZ-AU	
		<p>PCB CONTACTS: 27.5 [1.082\"/> </p>	XLR 3 pole male, D Flange, Machined contacts, Black Finish	Standard	AC3MMDZB
			Gold Plated Contacts	AC3MMDZB-AU	
		<p>SOLDER CONTACTS: 2.7 [.106\"/> </p>	XLR 3 pole male, D Flange, Stamped contacts, Nickel Finish	Standard	AC3MDZ
			Gold Plated Contacts	AC3MDZ-AU	
		<p>PCB CONTACTS: 27.5 [1.082\"/> </p>	XLR 3 pole male, D Flange, Stamped contacts, Black Finish	Standard	AC3MDZB
			Gold Plated Contacts	AC3MDZB-AU	
		<p>SOLDER CONTACTS: 6.5 [.256\"/> </p>	XLR 3 pole female, D Flange, Stamped contacts, Nickel Finish	Standard	AC3FDZ
			Gold Plated Contacts	AC3FDZ-AU	
		<p>PCB CONTACTS: 23.0 [0.907\"/> </p>	XLR 3 pole female, D Flange, Stamped contacts, Black Finish	Standard	AC3FDZB
			Gold Plated Contacts	AC3FDZB-AU	
		<p>PCB CONTACTS: 23.0 [0.907\"/> </p>	XLR 3 pole female, D Flange, Stamped contacts, Black Finish	Vertical PCB	AC3FDZVB
			Bulk Pack	AC3FDZB BULK	

PRODUCT - FIGURE	DRAWING	Dimensions in mm (inches)	DESCRIPTION	VARIATIONS	PART NUMBER
		<p>XLR 4 pole male, D Flange, Machined contacts, Nickel Finish</p>	Standard	AC4MDZ	
			Gold Plated Contacts	AC4MDZ-AU	
			Vertical PCB	AC4MDZV	
		<p>XLR 4 pole male, D Flange, Machined contacts, Black Finish</p>	Standard	AC4MDZB	
			Gold Plated Contacts	AC4MDZB-AU	
			Vertical PCB	AC4MDZVB	
		<p>XLR 4 pole female, D Flange, Machined contacts, Nickel Finish</p>	Standard	AC4FDZ	
			Gold Plated Contacts	AC4FDZ-AU	
			Vertical PCB	AC4FDZV	
		<p>XLR 4 pole female, D Flange, Machined contacts, Black Finish</p>	Standard	AC4FDZB	
			Gold Plated Contacts	AC4FDZB-AU	
			Vertical PCB	AC4FDZVB	
		<p>XLR 5 pole male, D Flange, Machined contacts, Nickel Finish</p>	Standard	AC5MDZ	
			Gold Plated Contacts	AC5MDZ-AU	
			Vertical PCB	AC5MDZV	
		<p>XLR 5 pole male, D Flange, Machined contacts, Black Finish</p>	Standard	AC5MDZB	
			Gold Plated Contacts	AC5MDZB-AU	
			Vertical PCB	AC5MDZVB	
		<p>XLR 5 pole female, D Flange, Machined contacts, Nickel Finish</p>	Standard	AC5FDZ	
			Gold Plated Contacts	AC5FDZ-AU	
			Vertical PCB	AC5FDZV	
		<p>XLR 5 pole female, D Flange, Machined contacts, Black Finish</p>	Standard	AC5FDZB	
			Gold Plated Contacts	AC5FDZB-AU	
			Vertical PCB	AC5FDZVB	
			Bulk Pack	AC5FDZB BULK	

PRODUCT - FIGURE	DRAWING	DESCRIPTION	VARIATIONS	PART NUMBER
		XLR 6A pole male, D Flange, Machined contacts, Nickel Finish	Standard	AC6AMDZ
			Gold Plated Contacts	AC6AMDZ-AU
			Vertical PCB	AC6AMDZV
			Bulk Pack	AC6AMDZ BULK
		XLR 6A pole male, D Flange, Machined contacts, Black Finish	Standard	AC6AMDZB
			Gold Plated Contacts	AC6AMDZB-AU
			Vertical PCB	AC6AMDZVB
			Bulk Pack	AC6AMDZB BULK
		XLR 6A pole female, D Flange, Machined contacts, Nickel Finish	Standard	AC6AFDZ
			Gold Plated Contacts	AC6AFDZ-AU
			Vertical PCB	AC6AFDZV
			Bulk Pack	AC6AFDZ BULK
		XLR 6A pole female, D Flange, Machined contacts, Black Finish	Standard	AC6AFDZB
			Gold Plated Contacts	AC6AFDZB-AU
			Vertical PCB	AC6AFDZVB
			Bulk Pack	AC6AFDZB BULK
		XLR 7 pole male, D Flange, Gold Plated Machined contacts, Nickel Finish	Standard	AC7MDZ
			Vertical PCB	AC7MDZV
			Bulk Pack	AC7MDZ BULK
				XLR 7 pole male, D Flange, Gold Plated Machined contacts, Black Finish
	Vertical PCB	AC7MDZVB		
	Bulk Pack	AC7MDZB BULK		
		XLR 7 pole female, D Flange, Gold Plated Machined contacts, Nickel Finish		
			Vertical PCB	AC7FDZV
			Bulk Pack	AC7FDZ BULK
				XLR 7 pole female, D Flange, Gold Plated Machined contacts, Black Finish
	Vertical PCB	AC7FDZVB		
	Bulk Pack	AC7FDZB BULK		



METAL P TYPE FLANGE - SOLDER AND PCB



Features:

- Zinc Diecast shell.
- The P size housing is the original wide flange front mounting XLR connector. PN is the original narrow, front mounting male connector.
- Solder Bucket connections.
- Vertical PCB mounting.
- Precision Machined or Stamped contacts (3 pin only).
- Leading first mate last break socket contact.
- Positive latch lock system.

Options: Stamped contacts (3 contact only), Gold plated contacts, Vertical PCB contacts, Black Finish, Non-Latching (Female only), Bulk Pack.











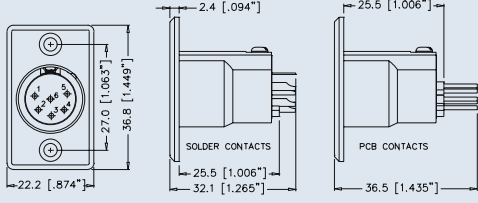

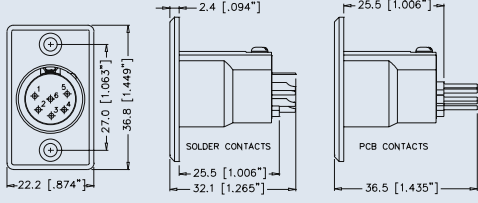

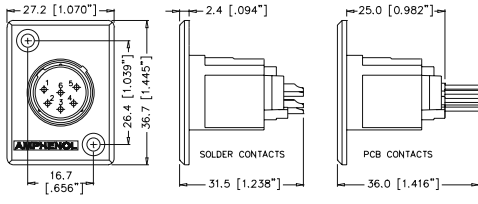
Part Number Breakdown: page 31 **Specifications:** page 32
PCB Footprints: page 33 **Panel Cutouts:** page 33

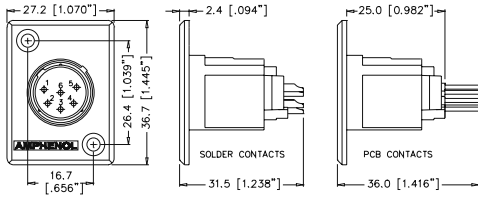
PRODUCT - FIGURE	DRAWING	Dimensions in mm (inches)	DESCRIPTION	VARIATIONS	PART NUMBER
		<p>2.4 [.094"]</p> <p>25.5 [1.004"]</p> <p>27.0 [1.063"]</p> <p>36.8 [1.449"]</p> <p>22.2 [.874"]</p> <p>32.1 [1.265"]</p> <p>36.5 [1.437"]</p>	<p>XLR 3 pole male, Narrow flange, Machined contacts, Nickel Finish</p>	Standard	AC3MMPNZ
				Gold Plated Contacts	AC3MMPNZ-AU
		<p>2.4 [.094"]</p> <p>25.5 [1.004"]</p> <p>27.0 [1.063"]</p> <p>36.8 [1.449"]</p> <p>22.2 [.874"]</p> <p>32.1 [1.265"]</p> <p>36.5 [1.437"]</p>	<p>XLR 3 pole male, Narrow flange, Machined contacts, Black Finish</p>	Standard	AC3MMPNZB
				Gold Plated Contacts	AC3MMPNZB-AU
		<p>2.4 [.094"]</p> <p>25.5 [1.004"]</p> <p>27.0 [1.063"]</p> <p>36.8 [1.449"]</p> <p>22.2 [.874"]</p> <p>32.1 [1.265"]</p> <p>36.5 [1.437"]</p>	<p>XLR 3 pole male, Narrow flange, Stamped contacts, Nickel Finish</p>	Standard	AC3MPNZ
				Gold Plated Contacts	AC3MPNZ-AU
		<p>2.4 [.094"]</p> <p>25.5 [1.004"]</p> <p>27.0 [1.063"]</p> <p>36.8 [1.449"]</p> <p>22.2 [.874"]</p> <p>32.1 [1.265"]</p> <p>36.5 [1.437"]</p>	<p>XLR 3 pole male, Narrow flange, Stamped contacts, Black Finish</p>	Standard	AC3MPNZB
				Gold Plated Contacts	AC3MPNZB-AU
		<p>2.4 [.094"]</p> <p>25.0 [0.982"]</p> <p>27.2 [1.070"]</p> <p>36.7 [1.445"]</p> <p>16.7 [.656"]</p> <p>31.5 [1.238"]</p> <p>36.0 [1.415"]</p>	<p>XLR 3 pole male, Wide flange, Machined contacts, Nickel Finish</p>	Standard	AC3MMP
				Gold Plated Contacts	AC3MMP-AU
		<p>2.4 [.094"]</p> <p>25.0 [0.982"]</p> <p>27.2 [1.070"]</p> <p>36.7 [1.445"]</p> <p>16.7 [.656"]</p> <p>31.5 [1.238"]</p> <p>36.0 [1.415"]</p>	<p>XLR 3 pole male, Wide flange, Machined contacts, Black Finish</p>	Standard	AC3MMPB
				Gold Plated Contacts	AC3MMPB-AU
		<p>2.4 [.094"]</p> <p>25.0 [0.982"]</p> <p>27.2 [1.070"]</p> <p>36.7 [1.445"]</p> <p>16.7 [.656"]</p> <p>31.5 [1.238"]</p> <p>36.0 [1.415"]</p>	<p>XLR 3 pole male, Wide flange, Stamped contacts, Nickel Finish</p>	Standard	AC3MMPV
				Gold Plated Contacts	AC3MMPV-AU
		<p>2.4 [.094"]</p> <p>25.0 [0.982"]</p> <p>27.2 [1.070"]</p> <p>36.7 [1.445"]</p> <p>16.7 [.656"]</p> <p>31.5 [1.238"]</p> <p>36.0 [1.415"]</p>	<p>XLR 3 pole male, Wide flange, Stamped contacts, Black Finish</p>	Standard	AC3MMPVB
				Gold Plated Contacts	AC3MMPVB-AU

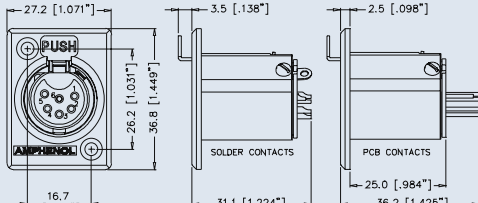

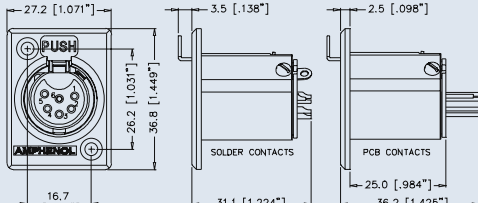

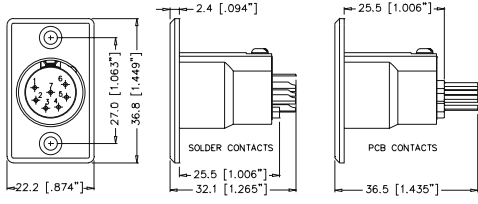

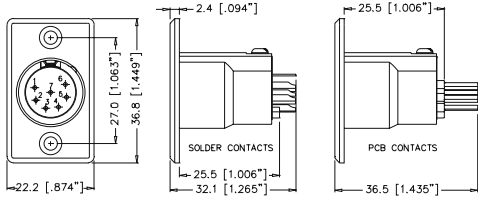
PRODUCT - FIGURE	DRAWING	Dimensions in mm (inches)	DESCRIPTION	VARIATIONS	PART NUMBER
		<p>27.2 [1.070"] 2.4 [.094"] 26.4 [1.039"] 36.7 [1.445"] 16.7 [.656"] 32.5 [1.278"] 25.0 [0.982"] 41.7 [1.640"]</p>	<p>XLR 3 pole male, Wide flange, Stamped contacts, Nickel Finish</p>	Standard	AC3MP
				Gold Plated Contacts	AC3MP-AU
		<p>27.2 [1.070"] 2.4 [.094"] 26.4 [1.039"] 36.7 [1.445"] 16.7 [.656"] 32.5 [1.278"] 25.0 [0.982"] 41.7 [1.640"]</p>	<p>XLR 3 pole male, Wide flange, Stamped contacts, Black Finish</p>	Vertical PCB	AC3MPV
				Bulk Pack	AC3MP BULK
		<p>27.2 [1.070"] 3.5 [.138"] 26.4 [1.039"] 36.7 [1.445"] 16.7 [.656"] 30.6 [1.204"] 2.5 [.098"] 23.5 [.927"] 40.5 [1.596"]</p>	<p>XLR 3 pole female, Wide flange, Stamped contacts, Nickel Finish</p>	Standard	AC3MPB
				Gold Plated Contacts	AC3MPB-AU
		<p>27.2 [1.070"] 3.5 [.138"] 26.4 [1.039"] 36.7 [1.445"] 16.7 [.656"] 30.6 [1.204"] 2.5 [.098"] 23.5 [.927"] 40.5 [1.596"]</p>	<p>XLR 3 pole female, Wide flange, Stamped contacts, Black Finish</p>	Vertical PCB	AC3MPVB
				Bulk Pack	AC3MPB BULK
		<p>27.2 [1.070"] 3.5 [.138"] 26.4 [1.039"] 36.7 [1.445"] 16.7 [.656"] 30.6 [1.204"] 2.5 [.098"] 23.5 [.927"] 40.5 [1.596"]</p>	<p>XLR 3 pole female, Wide flange, Stamped contacts, Nickel Finish</p>	Standard	AC3FPZ
				Gold Plated Contacts	AC3FPZ-AU
		<p>27.2 [1.070"] 3.5 [.138"] 26.4 [1.039"] 36.7 [1.445"] 16.7 [.656"] 30.6 [1.204"] 2.5 [.098"] 23.5 [.927"] 40.5 [1.596"]</p>	<p>XLR 3 pole female, Wide flange, Stamped contacts, Black Finish</p>	Vertical PCB	AC3FPZV
				Bulk Pack	AC3FPZ BULK
		<p>27.2 [1.070"] 2.4 [.094"] 27.0 [1.063"] 36.8 [1.449"] 22.2 [.874"] 32.1 [1.265"] 25.5 [1.004"] 36.5 [1.439"]</p>	<p>XLR 4 pole male, Nar- row flange, Machined contacts, Nickel Finish</p>	Standard	AC4MPNZ
				Gold Plated Contacts	AC4MPNZ-AU
		<p>27.2 [1.070"] 2.4 [.094"] 27.0 [1.063"] 36.8 [1.449"] 22.2 [.874"] 32.1 [1.265"] 25.5 [1.004"] 36.5 [1.439"]</p>	<p>XLR 4 pole male, Nar- row flange, Machined contacts, Black Finish</p>	Vertical PCB	AC4MPNZV
				Bulk Pack	AC4MPNZ BULK
		<p>27.2 [1.070"] 2.4 [.094"] 27.0 [1.063"] 36.8 [1.449"] 22.2 [.874"] 32.1 [1.265"] 25.5 [1.004"] 36.5 [1.439"]</p>	<p>XLR 4 pole male, Nar- row flange, Machined contacts, Black Finish</p>	Standard	AC4MPNZB
				Gold Plated Contacts	AC4MPNZB-AU
		<p>27.2 [1.070"] 2.4 [.094"] 27.0 [1.063"] 36.8 [1.449"] 22.2 [.874"] 32.1 [1.265"] 25.5 [1.004"] 36.5 [1.439"]</p>	<p>XLR 4 pole male, Nar- row flange, Machined contacts, Black Finish</p>	Vertical PCB	AC4MPNZVB
				Bulk Pack	AC4MPNZB BULK
		<p>27.2 [1.070"] 2.4 [.094"] 26.4 [1.039"] 36.7 [1.445"] 16.7 [.656"] 31.5 [1.238"] 25.0 [0.982"] 36.0 [1.417"]</p>	<p>XLR 4 pole male, Wide flange, Machined contacts, Nickel Finish</p>	Standard	AC4MP
				Gold Plated Contacts	AC4MP-AU
		<p>27.2 [1.070"] 2.4 [.094"] 26.4 [1.039"] 36.7 [1.445"] 16.7 [.656"] 31.5 [1.238"] 25.0 [0.982"] 36.0 [1.417"]</p>	<p>XLR 4 pole male, Wide flange, Machined contacts, Black Finish</p>	Vertical PCB	AC4MPV
				Bulk Pack	AC4MP BULK
		<p>27.2 [1.070"] 2.4 [.094"] 26.4 [1.039"] 36.7 [1.445"] 16.7 [.656"] 31.5 [1.238"] 25.0 [0.982"] 36.0 [1.417"]</p>	<p>XLR 4 pole male, Wide flange, Machined contacts, Black Finish</p>	Standard	AC4MPB
				Gold Plated Contacts	AC4MPB-AU
		<p>27.2 [1.070"] 2.4 [.094"] 26.4 [1.039"] 36.7 [1.445"] 16.7 [.656"] 31.5 [1.238"] 25.0 [0.982"] 36.0 [1.417"]</p>	<p>XLR 4 pole male, Wide flange, Machined contacts, Black Finish</p>	Vertical PCB	AC4MPVB
				Bulk Pack	AC4MPB BULK

PRODUCT - FIGURE	DRAWING	DESCRIPTION	VARIATIONS	PART NUMBER
		XLR 4 pole female, Wide flange, Machined contacts, Nickel Finish	Standard	AC4FPZ
			Gold Plated Contacts	AC4FPZ-AU
		XLR 4 pole female, Wide flange, Machined contacts, Black Finish	Vertical PCB	AC4FPZV
			Bulk Pack	AC4FPZ BULK
		XLR 4 pole female, Wide flange, Machined contacts, Black Finish	Standard	AC4FPZB
			Gold Plated Contacts	AC4FPZB-AU
		XLR 4 pole female, Wide flange, Machined contacts, Black Finish	Vertical PCB	AC4FPZVB
			Bulk Pack	AC4FPZB BULK
		XLR 5 pole male, Narrow flange, Machined contacts, Nickel Finish	Standard	AC5MPNZ
			Gold Plated Contacts	AC5MPNZ-AU
		XLR 5 pole male, Narrow flange, Machined contacts, Black Finish	Vertical PCB	AC5MPNZV
			Bulk Pack	AC5MPNZ BULK
		XLR 5 pole male, Narrow flange, Machined contacts, Black Finish	Standard	AC5MPNZB
			Gold Plated Contacts	AC5MPNZB-AU
		XLR 5 pole male, Narrow flange, Machined contacts, Black Finish	Vertical PCB	AC5MPNZVB
			Bulk Pack	AC5MPNZB BULK
		XLR 5 pole male, Wide flange, Machined contacts, Nickel Finish	Standard	AC5MP
			Gold Plated Contacts	AC5MP-AU
		XLR 5 pole male, Wide flange, Machined contacts, Black Finish	Vertical PCB	AC5MPV
			Bulk Pack	AC5MP BULK
		XLR 5 pole male, Wide flange, Machined contacts, Black Finish	Standard	AC5MPB
			Gold Plated Contacts	AC5MPB-AU
		XLR 5 pole male, Wide flange, Machined contacts, Black Finish	Vertical PCB	AC5MPVB
			Bulk Pack	AC5MPB BULK
		XLR 5 pole female, Wide flange, Machined contacts, Nickel Finish	Standard	AC5FPZ
			Gold Plated Contacts	AC5FPZ-AU
		XLR 5 pole female, Wide flange, Machined contacts, Black Finish	Vertical PCB	AC5FPZV
			Bulk Pack	AC5FPZ BULK
		XLR 5 pole female, Wide flange, Machined contacts, Black Finish	Standard	AC5FPZB
			Gold Plated Contacts	AC5FPZB-AU
		XLR 5 pole female, Wide flange, Machined contacts, Black Finish	Vertical PCB	AC5FPZVB
			Bulk Pack	AC5FPZB BULK

PRODUCT - FIGURE	DRAWING	Dimensions in mm (inches)	DESCRIPTION	VARIATIONS	PART NUMBER
		<p>2.4 [.094"]</p> <p>25.5 [1.006"]</p> <p>27.0 [1.063"]</p> <p>36.8 [1.449"]</p> <p>22.2 [.874"]</p> <p>25.5 [1.006"]</p> <p>32.1 [1.265"]</p> <p>36.5 [1.435"]</p>	<p>XLR 6A pole male, Narrow flange, Machined contacts, Nickel Finish</p>	Standard	AC6AMPNZ
Gold Plated Contacts				AC6AMPNZ-AU	
Vertical PCB				AC6AMPNZV	
Bulk Pack				AC6AMPNZ BULK	
		<p>2.4 [.094"]</p> <p>25.5 [1.006"]</p> <p>27.0 [1.063"]</p> <p>36.8 [1.449"]</p> <p>22.2 [.874"]</p> <p>25.5 [1.006"]</p> <p>32.1 [1.265"]</p> <p>36.5 [1.435"]</p>	<p>XLR 6A pole male, Narrow flange, Machined contacts, Black Finish</p>	Standard	AC6AMPNZB
Gold Plated Contacts				AC6AMPNZB-AU	
Vertical PCB				AC6AMPNZBV	
Bulk Pack				AC6AMPNZB BULK	
		<p>2.4 [.094"]</p> <p>25.0 [0.982"]</p> <p>27.2 [1.070"]</p> <p>36.7 [1.445"]</p> <p>26.4 [1.039"]</p> <p>16.7 [.656"]</p> <p>31.5 [1.238"]</p> <p>36.0 [1.416"]</p>	<p>XLR 6A pole male, Wide flange, Machined contacts, Nickel Finish</p>	Standard	AC6AMP
Gold Plated Contacts				AC6AMP-AU	
Vertical PCB				AC6AMPV	
Bulk Pack				AC6AMP BULK	
		<p>2.4 [.094"]</p> <p>25.0 [0.982"]</p> <p>27.2 [1.070"]</p> <p>36.7 [1.445"]</p> <p>26.4 [1.039"]</p> <p>16.7 [.656"]</p> <p>31.5 [1.238"]</p> <p>36.0 [1.416"]</p>	<p>XLR 6A pole male, Wide flange, Machined contacts, Black Finish</p>	Standard	AC6AMPB
Gold Plated Contacts				AC6AMPB-AU	
Vertical PCB				AC6AMPVB	
Bulk Pack				AC6AMPB BULK	
		<p>3.5 [.136"]</p> <p>2.5 [.098"]</p> <p>27.2 [1.071"]</p> <p>36.8 [1.449"]</p> <p>26.2 [1.031"]</p> <p>16.7 [.656"]</p> <p>31.1 [1.224"]</p> <p>36.2 [1.425"]</p>	<p>XLR 6A pole female, Wide flange, Machined contacts, Nickel Finish</p>	Standard	AC6AFPZ
Gold Plated Contacts				AC6AFPZ-AU	
Vertical PCB				AC6AFPZV	
Bulk Pack				AC6AFPZ BULK	
		<p>3.5 [.136"]</p> <p>2.5 [.098"]</p> <p>27.2 [1.071"]</p> <p>36.8 [1.449"]</p> <p>26.2 [1.031"]</p> <p>16.7 [.656"]</p> <p>31.1 [1.224"]</p> <p>36.2 [1.425"]</p>	<p>XLR 6A pole female, Wide flange, Machined contacts, Black Finish</p>	Standard	AC6AFPZB
Gold Plated Contacts				AC6AFPZB-AU	
Vertical PCB				AC6AFPZBV	
Bulk Pack				AC6AFPZB BULK	
		<p>2.4 [.094"]</p> <p>25.5 [1.006"]</p> <p>27.0 [1.063"]</p> <p>36.8 [1.449"]</p> <p>22.2 [.874"]</p> <p>25.5 [1.006"]</p> <p>32.1 [1.265"]</p> <p>36.5 [1.435"]</p>	<p>XLR 7 pole male, Narrow flange, Gold Plated Machined contacts, Nickel Finish</p>	Standard	AC7MPNZ
Vertical PCB				AC7MPNZV	
Bulk Pack				AC7MPNZ BULK	
					<p>2.4 [.094"]</p> <p>25.5 [1.006"]</p> <p>27.0 [1.063"]</p> <p>36.8 [1.449"]</p> <p>22.2 [.874"]</p> <p>25.5 [1.006"]</p> <p>32.1 [1.265"]</p> <p>36.5 [1.435"]</p>
Vertical PCB	AC7MPNZBV				
Bulk Pack	AC7MPNZB BULK				



PRODUCT - FIGURE	DRAWING	DESCRIPTION	VARIATIONS	PART NUMBER
		XLR 7 pole male, Wide flange, Gold Plated Machined contacts, Nickel Finish	Standard	AC7MP
			Vertical PCB	AC7MPV
			Bulk Pack	AC7MP BULK
		XLR 7 pole male, Wide flange, Gold Plated Machined contacts, Black Finish	Standard	AC7MPB
			Vertical PCB	AC7MPVB
			Bulk Pack	AC7MPB BULK
		XLR 7 pole female, Wide flange, Gold Plated Machined contacts, Nickel Finish	Standard	AC7FPZ
			Vertical PCB	AC7FPZV
			Bulk Pack	AC7FPZ BULK
		XLR 7 pole female, Wide flange, Gold Plated Machined contacts, Black Finish	Standard	AC7FPZB
			Vertical PCB	AC7FPZVB
			Bulk Pack	AC7FPZB BULK

PART NUMBER BREAKDOWN

METAL TYPE FLANGE

E. G. **AC3MMPNZVB-AU BULK**

AC (Series Prefix), **3** contacts, **M**ale, **M**achined Contacts, **PN** (Narrow Flange), **Z** (Metal Chassis Series), **V**ertical Printed Circuit Board, **B**lack Polyester Finish, **- AU** (Gold Plated Contacts), **BULK** Packaged.

SERIES PREFIX	AC	=	Series Prefix
CONTACT LAYOUTS	3	=	3 Contacts
	4	=	4 Contacts
	5	=	5 Contacts
	6A	=	6 Contacts
	7	=	7 Contacts
GENDER	F	=	Female Socket Contacts
	M	=	Male Pin Contacts
MACHINED CONTACTS¹	Blank	=	Stamped Contacts
	M	=	Machined Contacts (Applicable 3 male pin contacts only)
SHELL STYLE	D	=	Small Flange (front or rear mounting)
	P	=	Large Shell with wide flange
	PN	=	Large Shell with Narrow Flange (male only)
SHELL SERIES	Blank	=	Male P Shell Style only
	Z	=	Metal Chassis Series
TERMINATION	Blank	=	Solder Buckets
	V	=	Vertical Printed Circuit Board
SHELL FINISH²	Blank	=	Nickel Plated Finish
	B	=	Black Polyester Finish
CONTACT PLATING³	Blank	=	Standard Plating (Silver or Tin - Refer to Standard Data.)
	AU	=	Gold Plated
PACKAGING	Blank	=	Individual Bags
	BULK	=	Bulk Packed

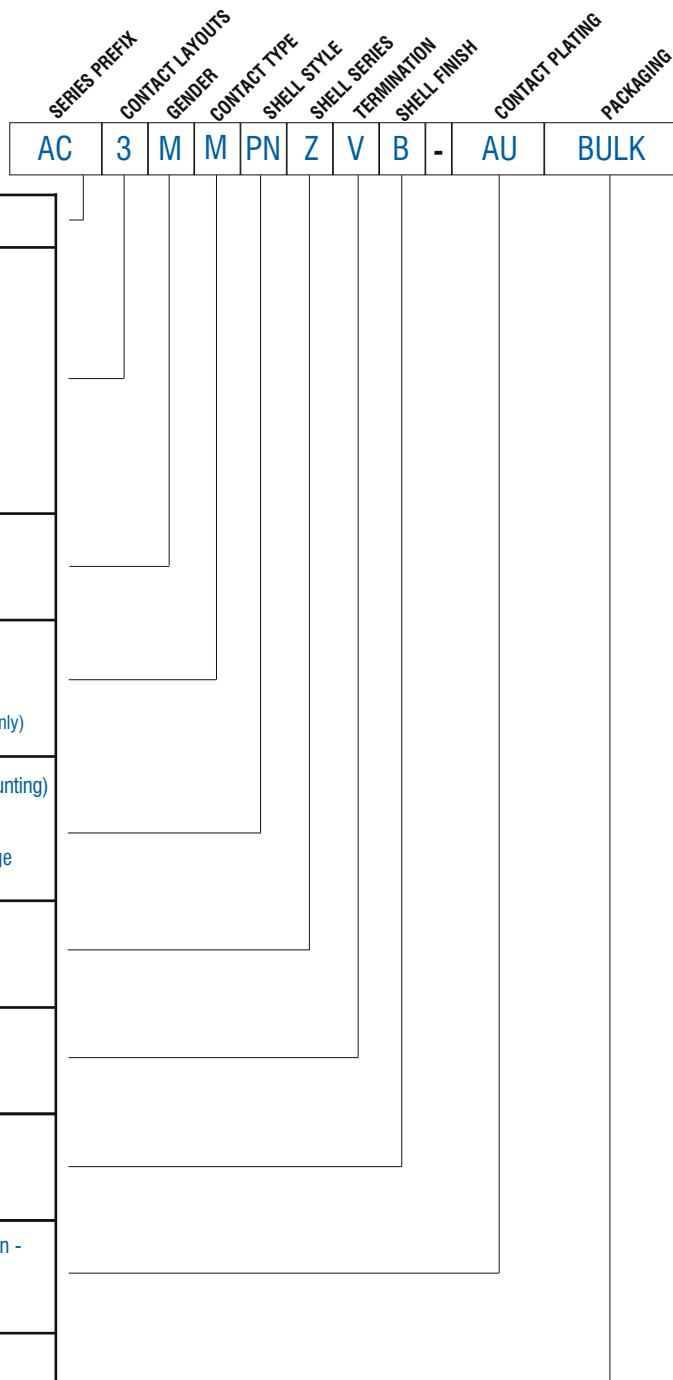

Note:

¹ 4 - 7 contact connectors have machined contacts and grounding as standard. They are not available in stamped contacts.

² Ground contacts are not supplied with the black polyester finish shell option.

³ 7 Contact is gold plated as standard.

⁴ Non-Latching Versions (Female) available - Please contact us for part number options.

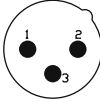
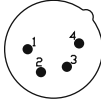
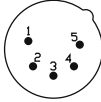
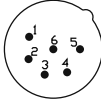
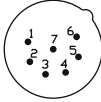

STANDARD DATA AC SERIES CHASSIS - METAL "Z"

		VALUE				
GENERAL CHARACTERISTICS	Number of contacts	3	4	5	6A	7
	Contact Arrangement (Front view of pin inserts)					
	Termination	Solder Bucket / Printed Circuit Board (PCB)				
	Max. Wire Gauge - Stranded wire:					
	Solder	14AWG	16AWG	18AWG	18AWG	20AWG
	Printed Circuit Board - PCB	N/A	N/A	N/A	N/A	N/A
Flammability rating of plastics	UL94V-0					
Environmental	Complies with EU RoHS 2 Directive 2011/65/EU					
ELECTRICAL CHARACTERISTICS	Service Voltage RMS	133V ¹⁾				
	Test Voltage AC RMS	1400V				
	Current carrying capacity:					
	Solder	15A	10A	7.5A	7.5A	5A
	Printed Circuit Board (PCB)	15A	10A	7.5A	7.5A	5A
	Typical Contact Resistance	≤3mΩ				
Insulation Resistance	≥1000MΩ					
CLIMATIC CHARACTERISTICS	Protection Class	IP40				
	Operating Temperature	-25 °C to +75 °C (-13°F to +167°F)				
MECHANICAL CHARACTERISTICS	Weight - Metal ²⁾	31g (0.068lb)	32g (0.070lb)	33g (0.072lb)	33g (0.072lb)	33g (0.072lb)
	Mechanical Operations	1000 mating cycles				
MATERIALS	Connector Shell	Diecast Zinc Alloy				
	Shell Finish	Satin Nickel or Black Polyester				
	Insulators	UL94V-0 PBT Resin or Modified PPE Resin				
	Male Contact					
	Stamped Solder and PCB-(Material/Plating)	Phosphor Bronze / Silver or Gold (optional)				
	Machined Solder-(Material/Plating)	Brass / Silver or Gold (optional)				
	Female Contact					
Stamped Solder and PCB-(Material/Plating)	Phosphor Bronze / Tin or Gold (optional)					
Machined Solder-(Material/Plating)	Brass / Silver or Gold (Optional)					

Rev 3 - 03/2013

¹⁾ Not suitable for domestic applications above 50V

²⁾ Approximate weight only, does not include packaging. Please contact us for exact weight for shipping purposes.

AC SERIES CHASSIS METAL "Z"

PCB FOOTPRINTS STRAIGHT (V)

CONNECTOR SIDE OF PCB

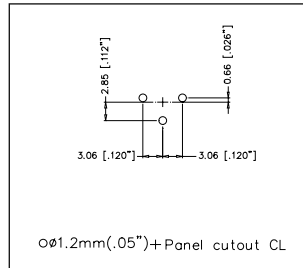

Ø1.2mm(.05") + Panel cutout CL

AC3F*ZV

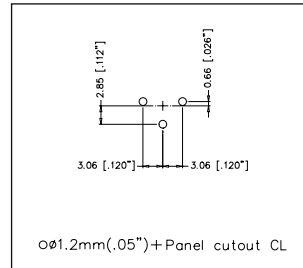

Ø1.2mm(.05") + Panel cutout CL

AC3M*ZV

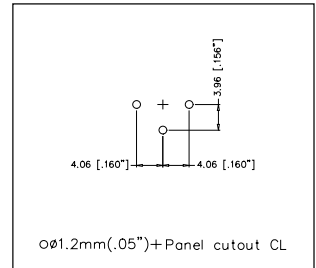

Ø1.2mm(.05") + Panel cutout CL

AC3MM*ZV

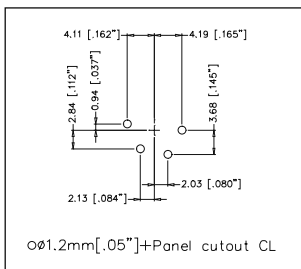

Ø1.2mm(.05") + Panel cutout CL

AC4F*ZV

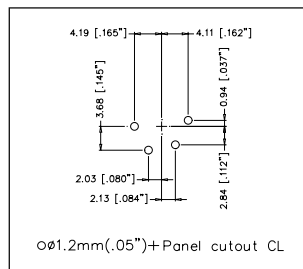

Ø1.2mm(.05") + Panel cutout CL

AC4M*ZV

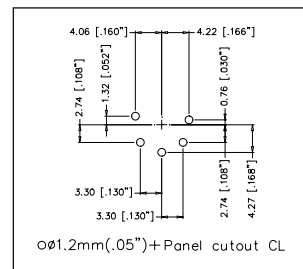

Ø1.2mm(.05") + Panel cutout CL

AC5F*ZV

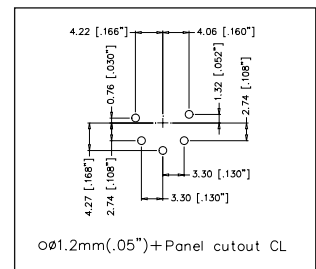

Ø1.2mm(.05") + Panel cutout CL

AC5M*ZV

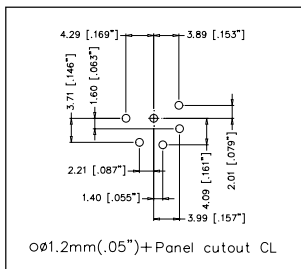

Ø1.2mm(.05") + Panel cutout CL

AC6AF*ZV

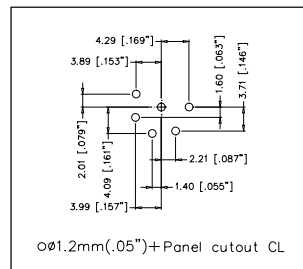

Ø1.2mm(.05") + Panel cutout CL

AC6AM*ZV

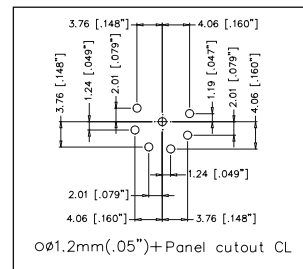

Ø1.2mm(.05") + Panel cutout CL

AC7F*ZV

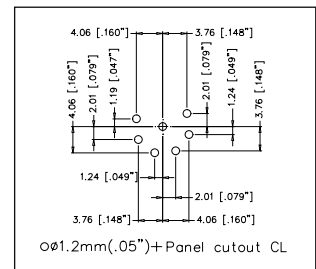

Ø1.2mm(.05") + Panel cutout CL

AC7M*ZV

PANEL CUTOUT DIMENSIONS

FRONT VIEW

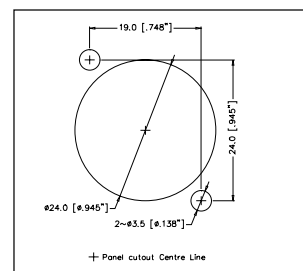

AC*FDZ

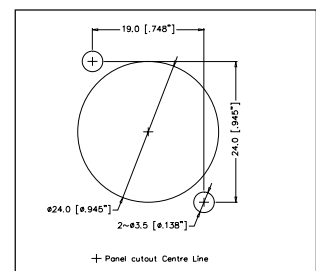

AC*MDZ

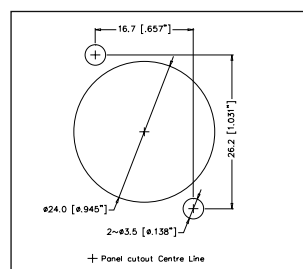

AC*FPZ

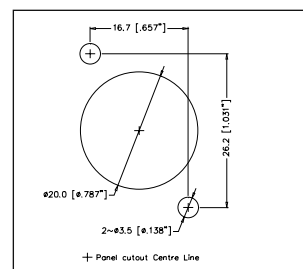

AC*MP

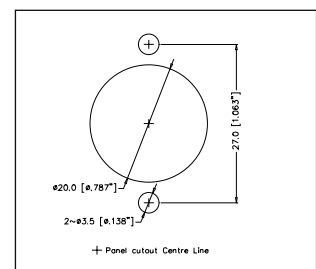

AC*MPNZ



AC SERIES XLR PCB CHASSIS MOUNT CONNECTORS

The AC series, A and B type XLR chassis receptacles have been designed and manufactured with the Original Equipment Manufacturers' (OEM) needs in mind. The compact shell design allows a significant space saving over the traditional 'D' type shell. Gold plated contacts improve the performance, ensuring a reliable contact and the unique grounding link options offer flexibility in design.

Features

- A leading first mate last break socket contact is standard on all female connectors (Pin 1).
- Vertical and Horizontal PCB versions available.
- Latching and Non-latching versions available.
- A range of different grounding options are available including:
 - Mating connector shell to Pin 1
 - Mating connector shell to Chassis
 - Mating connector shell to pin 1 to Chassis
- A type is available in 3 or 5 contacts.
- B type is available in 3 contact only.
- Compatible with all other XLR brands.
- Metal Mounting Flange (B type)

Options

- Vertical PCB contacts
- Horizontal PCB contacts
- Precision Machined Pin contacts
- Cost effective Stamped Socket contacts
- Gold Plated contacts (Standard)
- Silver Plated contacts (Optional)
- Bulk Packaging
- Integrated Switch

Ordering Codes

We have listed the more common ordering codes in each section. For further options please refer to the part number breakdown charts. Please contact us if you need any further assistance.

Simple steps to guide you in using this catalogue

- 1) Identify the product group listed in Contents on page 1 and go directly to that page number.
- 2) Each product group cover page then details information and options available.
- 3) Refer to the product detail pages and identify the product you require pictorially.
- 4) Read the product description column for the products standard features.
- 5) Use variations column to determine your choice.
- 6) Identify part number.
- 7) In the event the particular option you require is not listed please refer to the part number breakdown page at the end of each section.
- 8) Please contact us directly if you have any further problems.

THERMOPLASTIC A - TYPE FLANGE 3 CONTACT

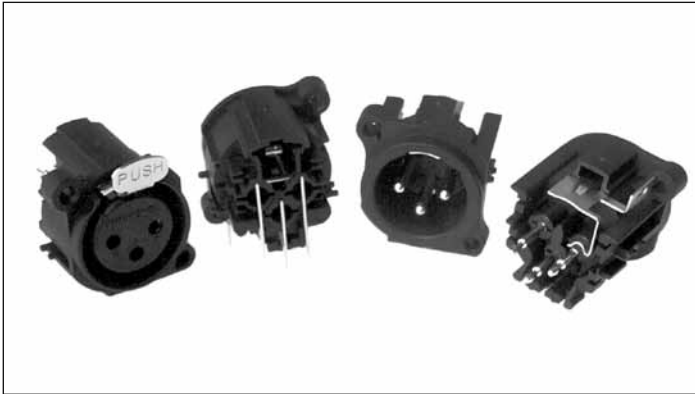

Features:

- Thermoplastic Shell
- Industry standard PCB footprints.
- Vertical or Horizontal PCB mounting.
- Precision machined pin contacts.
- Gold plated contacts.
- Leading first mate last break socket contact.
- Bulk packed in trays, 100 to a box as standard.
- Positive latch lock system.

Options: Silver plated contacts, Vertical or Horizontal PCB, Various grounding methods, Latching or Non-Latching.

Part Number Breakdown: [page 44](#) **Specifications:** [page 47](#)
PCB Footprints: [page 48](#) **Panel Cutouts:** [page 49](#)
Recommended Fastener: [page 137](#)











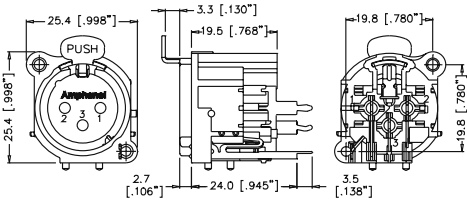

PRODUCT - FIGURE	DRAWING	Dimensions in mm (inches)	DESCRIPTION	GROUND LINK VARIATIONS	PART NUMBER
			XLR 3 pole male, Horizontal PCB, Gold Plated Contacts, Bulk Pack	No Ground Link	AC3MAH-AU-B
			XLR 3 pole male, Horizontal PCB, Gold Plated Contacts, Bulk Pack	Pin 1 to Chassis to Mating connector shell	AC3MAH1-AU-B
			XLR 3 pole male, Horizontal PCB, Gold Plated Contacts, Bulk Pack	Mating connector shell to Chassis - Pin 1 sep. Ground	AC3MAH2-AU-B
			XLR 3 pole male, Horizontal PCB, Gold Plated Contacts, Bulk Pack	Mating connector shell to Pin 1	AC3MAH3-AU-B
			XLR 3 pole male, Horizontal PCB, Gold Plated Contacts, Bulk Pack	Mating connector shell to Chassis to PCB, Pin 1 sep. Ground	AC3MAH4-AU-B
			XLR 3 pole male with integrated switch, Horizontal PCB, Gold Plated Contacts, Bulk Pack	Mating connector shell to Chassis to PCB, Pin 1 sep. Ground	AC3MAH4-SW-B

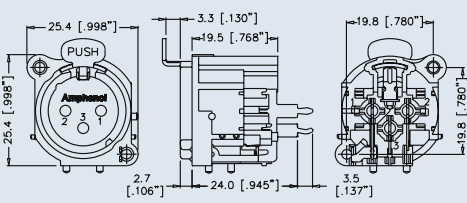
PRODUCT - FIGURE	DRAWING Dimensions in mm (inches)	DESCRIPTION	GROUND LINK VARIATIONS	PART NUMBER
		XLR 3 pole male, Vertical PCB, Gold Plated Contacts, Bulk Pack	No Ground Link	AC3MAV-AU-B
		XLR 3 pole male, Vertical PCB, Gold Plated Contacts, Bulk Pack	Pin 1 to Chassis to Mating connector shell	AC3MAV1-AU-B
		XLR 3 pole male, Vertical PCB, Gold Plated Contacts, Bulk Pack	Mating connector shell to Chassis - Pin 1 sep. Ground	AC3MAV2-AU-B
		XLR 3 pole male, Vertical PCB, Gold Plated Contacts, Bulk Pack	Mating connector shell to Pin 1	AC3MAV3-AU-B
		XLR 3 pole male, Vertical PCB, Gold Plated Contacts, Bulk Pack	Mating connector shell to Chassis to PCB, Pin 1 sep. ground	AC3MAV4-AU-B
		XLR 3 pole male, Solder Buckets, Gold Plated Contacts, Bulk Pack	No Ground Link	AC3MA-AU-B
		XLR 3 pole female, Horizontal PCB, Latching Type, Gold Plated Contacts, Bulk Pack	No Ground Link	AC3FAH-AU-B
		XLR 3 pole female, Horizontal PCB, Latching Type, Gold Plated Contacts, Bulk Pack	Pin 1 to Chassis to Mating connector shell	AC3FAH1-AU-B

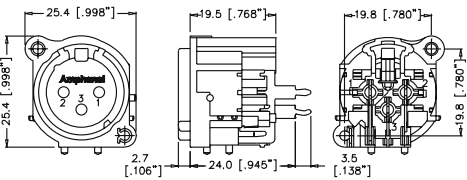

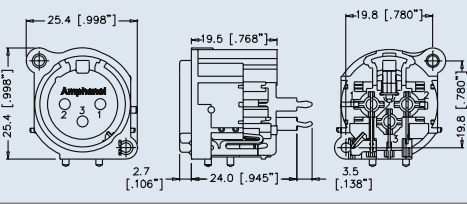
PRODUCT - FIGURE	DRAWING	Dimensions in mm (inches)	DESCRIPTION	GROUND LINK VARIATIONS	PART NUMBER
			XLR 3 pole female, Horizontal PCB, Latching Type, Gold Plated Contacts, Bulk Pack	Mating connector shell to Chassis - Pin 1 sep. Ground	AC3FAH2-AU-B
			XLR 3 pole female, Horizontal PCB, Latching Type, Gold Plated Contacts, Bulk Pack	Pin 1 to Chassis	AC3FAH3-AU-B
			XLR 3 pole female, Horizontal PCB, Non-Latching Type Gold Plated Contacts, Bulk Pack	No Ground Link	AC3FAHL-AU-B
			XLR 3 pole female, Horizontal PCB, Non-Latching Type Gold Plated Contacts, Bulk Pack	Pin 1 to Chassis to mating connector shell	AC3FAHL1-AU-B
			XLR 3 pole female, Horizontal PCB, Non-Latching Type Gold Plated Contacts, Bulk Pack	Mating connector shell to Chassis - Pin 1 sep. Ground.	AC3FAHL2-AU-B
			XLR 3 pole female, Horizontal PCB, Non-Latching Type Gold Plated Contacts, Bulk Pack	Pin 1 to Chassis	AC3FAHL3-AU-B
			XLR 3 pole female, Vertical PCB, Latching Type, Gold Plated Contacts, Bulk Pack	No Ground Link	AC3FAV-AU-B
			XLR 3 pole female, Vertical PCB, Latching Type, Gold Plated Contacts, Bulk Pack	Pin 1 to Chassis to mating connector shell	AC3FAV1-AU-B

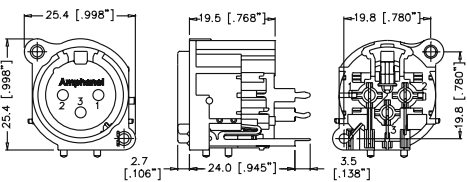

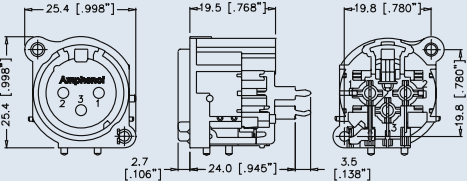
PRODUCT - FIGURE	DRAWING	DESCRIPTION	GROUND LINK VARIATIONS	PART NUMBER
		XLR 3 pole female, Vertical PCB, Latching Type, Gold Plated Contacts, Bulk Pack	Mating connector shell to Chassis - Pin 1 sep. Ground.	AC3FAV2-AU-B
		XLR 3 pole female, Vertical PCB, Latching Type, Gold Plated Contacts, Bulk Pack	Pin 1 to Chassis	AC3FAV3-AU-B
		XLR 3 pole female, Vertical PCB, Non-Latching Type, Gold Plated Contacts, Bulk Pack	No Ground Link	AC3FAVL-AU-B
		XLR 3 pole female, Vertical PCB, Non-Latching Type, Gold Plated Contacts, Bulk Pack	Pin 1 to Chassis to Mating connector shell	AC3FAVL1-AU-B
		XLR 3 pole female, Vertical PCB, Non-Latching Type, Gold Plated Contacts, Bulk Pack	Mating connector shell to Chassis - Pin 1 sep. Ground.	AC3FAVL2-AU-B
		XLR 3 pole female, Vertical PCB, Non-Latching Type, Gold Plated Contacts, Bulk Pack	Pin 1 to Chassis	AC3FAVL3-AU-B





Features:

- Thermoplastic Shell with Metal Mounting Flange.
- Industry standard PCB footprints.
- Improved grounding performance.
- Vertical or Horizontal PCB mounting.
- Precision machined pin contacts.
- Gold plated contacts.
- Leading first mate last break socket contact.
- Bulk packed in trays, 100 to a box as standard.
- Positive latch lock system.

Options: Silver plated contacts, Vertical or Horizontal PCB, Various grounding methods, Latching or Non-Latching.

Part Number Breakdown: page 45 **Specifications:** page 47
PCB Footprints: page 48 **Panel Cutouts:** page 49
Recommended Fastener: page 137







PRODUCT - FIGURE	DRAWING	Dimensions in mm (inches)	DESCRIPTION/ GROUND LINK	MOUNTING FLANGE VARIATIONS	PART NUMBER
		25.3 [.996"] 25.3 [.996"] 19.5 [.768"] 2.7 [.106"] 3.5 [.139"] 19.8 [.780"] 12.5 [.492"] 19.8 [.780"]	XLR 3 pole male, Horizontal PCB, Gold Plated Contacts, Bulk Pack	Nickel Finish	AC3MBH-AU-B
			No Ground Link	Black Finish	AC3MBHB-AU-B
		25.3 [.996"] 25.3 [.996"] 19.5 [.768"] 2.7 [.106"] 3.5 [.139"] 19.8 [.780"] 12.7 [.500"] 19.8 [.780"]	XLR 3 pole male, Horizontal PCB, Gold Plated Contacts, Bulk Pack	Nickel Finish	AC3MBH1-AU-B
			Pin 1 to Chassis to Mating connector shell	Black Finish	AC3MBHB1-AU-B
		25.3 [.996"] 25.3 [.996"] 19.5 [.768"] 2.7 [.106"] 3.5 [.136"] 19.8 [.780"] 12.5 [.492"] 19.8 [.780"]	XLR 3 pole male, Horizontal PCB, Gold Plated Contacts, Bulk Pack	Nickel Finish	AC3MBH2-AU-B
			Mating connector shell to Chassis - Pin 1 sep. Ground	Black Finish	AC3MBHB2-AU-B
		25.3 [.996"] 25.3 [.996"] 19.5 [.768"] 2.7 [.106"] 3.5 [.139"] 19.8 [.780"] 12.5 [.492"] 19.8 [.780"]	XLR 3 pole male, Horizontal PCB, Gold Plated Contacts, Bulk Pack	Nickel Finish	AC3MBH3-AU-B
			Mating connector shell to Pin 1	Black Finish	AC3MBHB3-AU-B
		25.3 [.996"] 25.3 [.996"] 19.5 [.768"] 2.7 [.106"] 3.5 [.139"] 19.8 [.780"] 12.5 [.492"] 19.8 [.780"]	XLR 3 pole male, Horizontal PCB, Non-Latching Type, Gold Plated Contacts, Bulk Pack	Nickel Finish	AC3MBHL-AU-B
			No Ground Link	Black Finish	AC3MBHBL-AU-B
		25.3 [.996"] 25.3 [.996"] 19.5 [.768"] 2.7 [.106"] 3.5 [.138"] 24.0 [.945"] 19.8 [.780"] 12.5 [.492"] 19.8 [.780"]	XLR 3 pole male, Vertical PCB, Gold Plated Contacts, Bulk Pack	Nickel Finish	AC3MBV-AU-B
			No Ground Link	Black Finish	AC3MBVB-AU-B

PRODUCT - FIGURE	DRAWING	Dimensions in mm (inches)	DESCRIPTION/ GROUND LINK	MOUNTING FLANGE VARIATIONS	PART NUMBER
			XLR 3 pole male, Vertical PCB, Gold Plated Contacts, Bulk Pack Pin 1 to Chassis to Mating connector shell	Nickel Finish Black Finish	AC3MBV1-AU-B AC3MBVB1-AU-B
			XLR 3 pole male, Vertical PCB, Gold Plated Contacts, Bulk Pack Mating connector shell to Chassis - Pin 1 sep. Ground	Nickel Finish Black Finish	AC3MBV2-AU-B AC3MBVB2-AU-B
			XLR 3 pole male, Vertical PCB, Gold Plated Contacts, Bulk Pack Mating connector shell to Pin 1	Nickel Finish Black Finish	AC3MBV3-AU-B AC3MBVB3-AU-B
			XLR 3 pole female, Horizontal PCB, Latching Type, Gold Plated Contacts, Bulk Pack No Ground Link	Nickel Finish Black Finish	AC3FBH-AU-B AC3FBHB-AU-B
			XLR 3 pole female, Horizontal PCB, Latching Type, Gold Plated Contacts, Bulk Pack Pin 1 to Chassis to Mating connector shell	Nickel Finish Black Finish	AC3FBH1-AU-B AC3FBHB1-AU-B
			XLR 3 pole female, Horizontal PCB, Latching Type, Gold Plated Contacts, Bulk Pack Mating connector shell to Chassis - Pin 1 sep. Ground	Nickel Finish Black Finish	AC3FBH2-AU-B AC3FBHB2-AU-B
			XLR 3 pole female, Horizontal PCB, Latching Type, Gold Plated Contacts, Bulk Pack Pin 1 to Chassis	Nickel Finish Black Finish	AC3FBH3-AU-B AC3FBHB3-AU-B
			XLR 3 pole female, Horizontal PCB, Non-Latching Type Gold Plated Contacts, Bulk Pack No Ground Link	Nickel Finish Black Finish	AC3FBHL-AU-B AC3FBHBL-AU-B



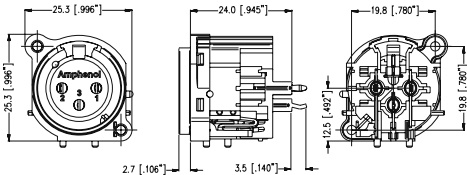

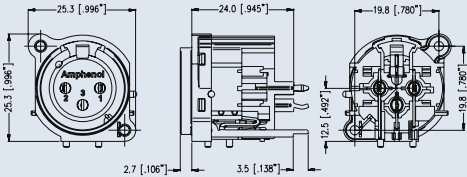
PRODUCT - FIGURE	DRAWING	Dimensions in mm (inches)	DESCRIPTION/ GROUND LINK	MOUNTING FLANGE VARIATIONS	PART NUMBER
			XLR 3 pole female, Horizontal PCB, Non-Latching Type Gold Plated Contacts, Bulk Pack Pin 1 to Chassis to mat- ing connector shell	Nickel Finish Black Finish	AC3FBHL1-AU-B AC3FBHL1-AU-B
			XLR 3 pole female, Horizontal PCB, Non- Latching Type, Gold Plated Contacts, Bulk Pack Mating connector shell to Chassis - Pin 1 sep. Ground.	Nickel Finish Black Finish	AC3FBHL2-AU-B AC3FBHL2-AU-B
			XLR 3 pole female, Horizontal PCB, Non-Latching Type Gold Plated Contacts, Bulk Pack Pin 1 to Chassis	Nickel Finish Black Finish	AC3FBHL3-AU-B AC3FBHL3-AU-B
			XLR 3 pole female, Vertical PCB, Latching Type, Gold Plated Contacts, Bulk Pack No Ground Link	Nickel Finish Black Finish	AC3FBV-AU-B AC3FBVB-AU-B
			XLR 3 pole female, Vertical PCB, Latching Type, Gold Plated Contacts, Bulk Pack Pin 1 to Chassis to mating connector shell	Nickel Finish Black Finish	AC3FBV1-AU-B AC3FBV1-AU-B
			XLR 3 pole female, Vertical PCB, Latching Type, Gold Plated Contacts, Bulk Pack Mating connector shell to Chassis - Pin 1 sep. Ground.	Nickel Finish Black Finish	AC3FBV2-AU-B AC3FBV2-AU-B
			XLR 3 pole female, Vertical PCB, Latching Type, Gold Plated Contacts, Bulk Pack Pin 1 to Chassis	Nickel Finish Black Finish	AC3FBV3-AU-B AC3FBV3-AU-B
			XLR 3 pole female, Vertical PCB, Non-Latching Type, Gold Plated Contacts, Bulk Pack No Ground Link	Nickel Finish Black Finish	AC3FBVL-AU-B AC3FBVL-AU-B

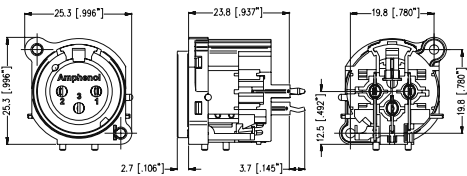
PRODUCT - FIGURE	DRAWING	Dimensions in mm (inches)	DESCRIPTION/ GROUND LINK	MOUNTING FLANGE VARIATIONS	PART NUMBER
			XLR 3 pole female, Vertical PCB, Non-Latching Type, Gold Plated Contacts, Bulk Pack Pin 1 to Chassis to Mat- ing connector shell	Nickel Finish	AC3FBVL1-AU-B
				Black Finish	AC3FBVL1-AU-B
			XLR 3 pole female, Vertical PCB, Non-Latching Type, Gold Plated Contacts, Bulk Pack Mating connector shell to Chassis-Pin 1 sep. Ground.	Nickel Finish	AC3FBVL2-AU-B
				Black Finish	AC3FBVL2-AU-B
			XLR 3 pole female, Vertical PCB, Non-Latching Type, Gold Plated Contacts, Bulk Pack Pin 1 to Chassis	Nickel Finish	AC3FBVL3-AU-B
				Black Finish	AC3FBVL3-AU-B



THERMOPLASTIC A - TYPE FLANGE 5 CONTACT



Features:

- 5 contacts.
- Thermoplastic Shell
- Industry standard PCB footprints.
- Vertical or Horizontal PCB mounting.
- Precision machined pin contacts.
- Gold plated contacts.
- Leading first mate last break socket contact.
- Bulk packed in trays, 100 to a box as standard.
- Positive latch lock system.

Options: Vertical or Horizontal PCB,

Part Number Breakdown: page 46 **Specifications:** page 47
PCB Footprints: page 48 **Panel Cutouts:** page 49
Recommended Fastener: page 137



PRODUCT - FIGURE	DRAWING	Dimensions in mm (inches)	DESCRIPTION/ GROUND LINK	MOUNTING FLANGE VARIATIONS	PART NUMBER
			XLR 5 pole male, Horizontal PCB, Gold Plated Contacts, Bulk Pack	Mating connector shell to Chassis to PCB, Pin 1 sep. Ground	AC5MAH-AU-B
			XLR 5 pole male, Verti- cal PCB, Gold Plated Contacts, Bulk Pack	Mating connector shell to Chassis to PCB, Pin 1 sep. Ground	AC5MAV-AU-B
			XLR 5 pole female, Horizontal PCB, Gold Plated Contacts, Bulk Pack	Mating connector shell to Chassis to PCB, Pin 1 sep. Ground	AC5FAH-AU-B
			XLR 5 pole female, Vertical PCB, Gold Plated Contacts, Bulk Pack	Mating connector shell to Chassis to PCB, Pin 1 sep. Ground	AC5FAV-AU-B

PART NUMBER BREAKDOWN

AC SERIES A AND B TYPE MALE - 3 CONTACT



E. G . **AC3MAVL3-AU B**

AC (series prefix), **3** contacts, **M**ale, **A** Type, **V**ertical Printed Circuit Board, **L**atchless, **3** (Mating Shell to Pin 1 Grounding), - **AU** (Gold Plated Contacts), **B**ulk Packaged.

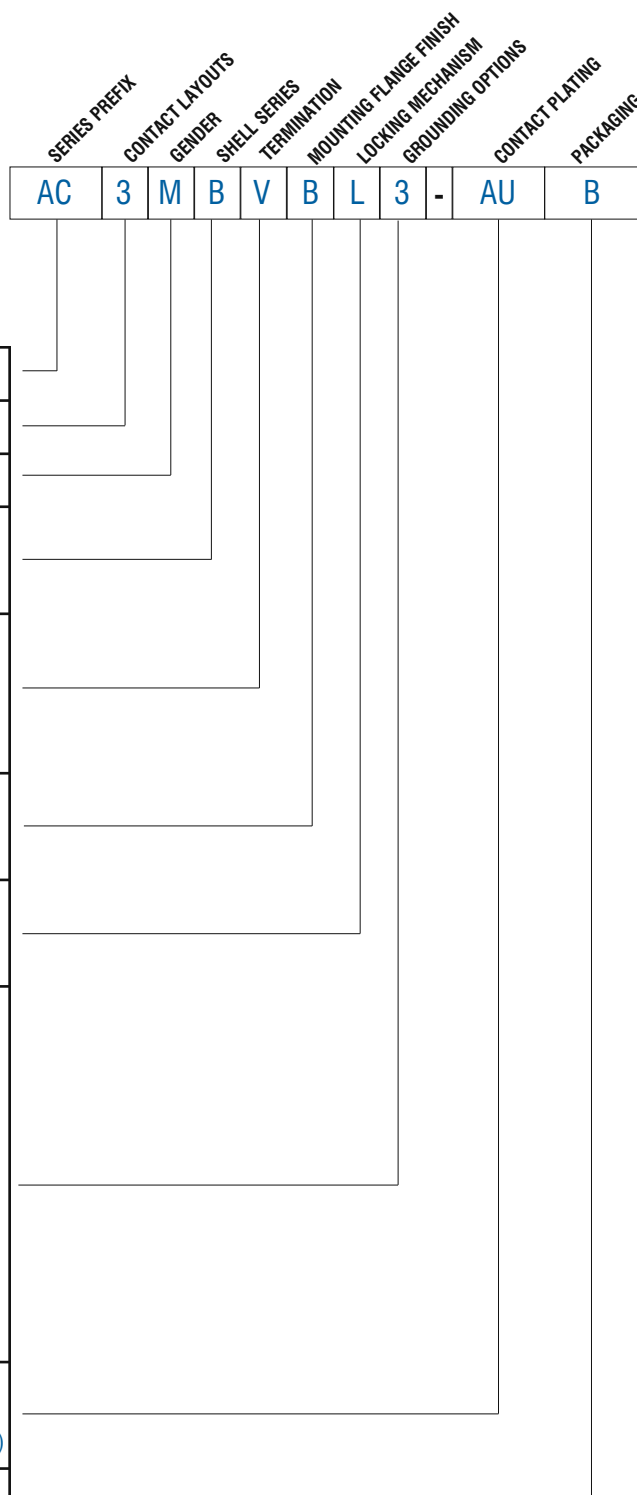

SERIES PREFIX	AC	=	Series Prefix
CONTACT LAYOUT	3	=	3 Contacts only
GENDER	M	=	Male Pin Contacts
SHELL SERIES	A	=	A Type
	B	=	B Type
TERMINATION	H	=	Horizontal Printed Circuit Board
	V	=	Vertical Printed Circuit Board
	Blank	=	Solder Bucket Contacts
MOUNTING FLANGE FINISH (B TYPE ONLY)	Blank	=	Nickel
	B	=	Black
LOCKING MECHANISM	Blank	=	Latching
	L	=	Latchless
GROUNDING LINK OPTIONS	Blank	=	No Ground Link
	1	=	Pin 1 to Chassis to mating connector shell
	2	=	Mating connector shell to Chassis, Pin 1 separate ground.
	3	=	Mating connector to Pin 1
	4	=	Mating connector to Shell to Chassis to PCB, Pin 1 separate ground
CONTACT PLATING	AU	=	Gold Plated Contacts
	AG	=	Silver Plated Contacts (Non-Standard)
PACKAGING	B	=	Bulk Packed

PART NUMBER BREAKDOWN

AC SERIES A AND B TYPE FEMALE - 3 CONTACT

E. G. **AC3FAVL3-AU B**

AC (series prefix), **3** contacts, **F**emale, **A** Type, Vertical Printed Circuit Board, Latchless, **3** (Pin 1 to Chassis Grounding), - **AU** (Gold Plated Contacts), **B**ulk Packaged.

SERIES PREFIX	AC	=	Series Prefix
CONTACT LAYOUT	3	=	3 Contacts only
GENDER	F	=	Female Socket Contacts
SHELL SERIES	A	=	A Type
	B	=	B Type
TERMINATION	H	=	Horizontal Printed Circuit Board
	V	=	Vertical Printed Circuit Board
MOUNTING FLANGE FINISH (B TYPE ONLY)	Blank	=	Nickel
	B	=	Black
LOCKING MECHANISM	Blank	=	Latching
	L	=	Latchless
GROUNDING LINK OPTIONS	Blank	=	No Ground Link
	1	=	Pin 1 to Chassis to mating connector shell
	2	=	Mating connector shell to Chassis, Pin 1 separate ground.
	3	=	Pin 1 to Chassis
CONTACT PLATING	AU	=	Gold Plated Contacts
	AG	=	Silver Plated Contacts (Non-Standard)
PACKAGING	B	=	Bulk Packed

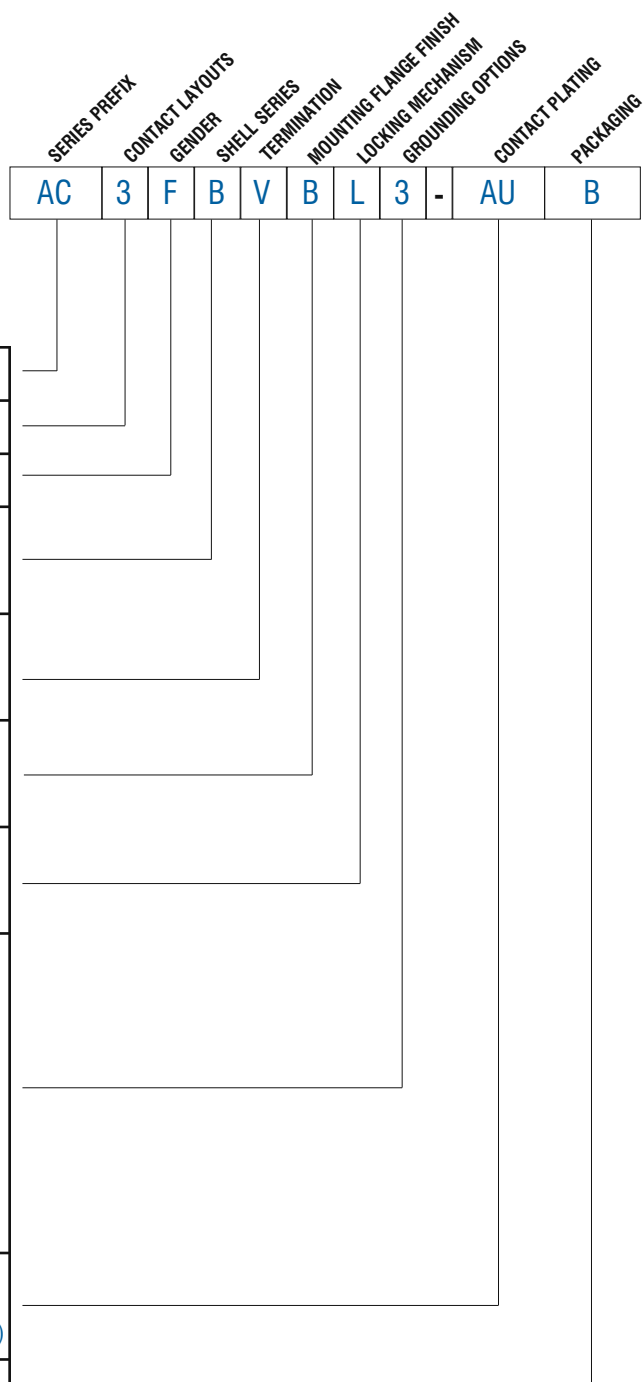

PART NUMBER BREAKDOWN

AC SERIES A TYPE MALE AND FEMALE - 5 CONTACT



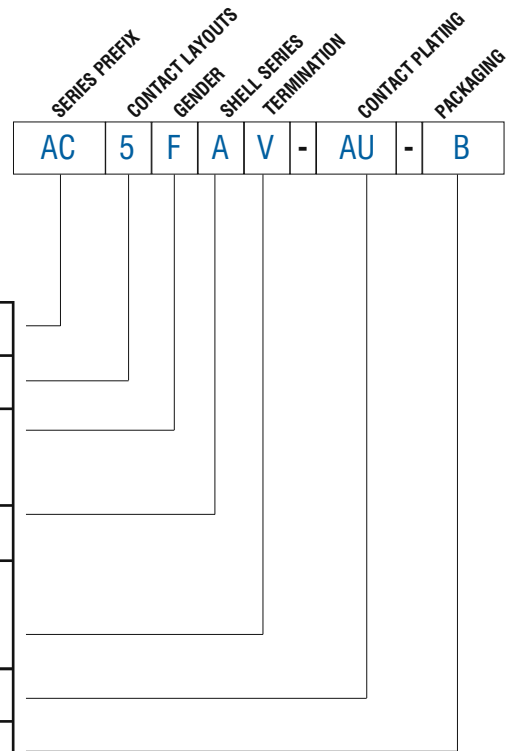

E. G . **AC5FAV-AU-B**
AC (series prefix), **5** contacts, **F**emale, **A** Type, **V**ertical Printed Circuit Board,
AU (Gold Plated Contacts) - **B**ulk Packaged.

SERIES PREFIX	AC	=	Series Prefix
CONTACT LAYOUT	5	=	5 Contacts only
GENDER	F	=	Female Socket Contacts
	M	=	Male Pin Contacts
SHELL SERIES	A	=	A Type
TERMINATION	H	=	Horizontal Printed Circuit Board
	V	=	Vertical Printed Circuit Board
CONTACT PLATING	AU	=	Gold Plated Contacts
PACKAGING	B	=	Bulk Packed



STANDARD DATA AC SERIES A AND B TYPE CHASSIS

		VALUE	
GENERAL CHARACTERISTICS	Number of contacts	3	5
	Contact Arrangements (Front view of pin insert)		
	Termination	Printed Circuit Board (PCB)	
	Flammability rating of plastics	UL94V-0	UL94HB
	Environmental	Complies with EU RoHS 2 Directive 2011/65/EU	
ELECTRICAL CHARACTERISTICS	Service Voltage RMS	133V ¹⁾	
	Test Voltage AC RMS	1500V	
	Current carrying capacity	6A	3A
	Typical Contact Resistance	≤5mΩ	
	Insulation Resistance (initial)	≥2GΩ	
	Insulation Resistance (after damp heat test)	≥1GΩ	
CLIMATIC CHARACTERISTICS	Protection Class	IP40	
	Operating Temperature	-25 °C to +75 °C (-13°F to +167°F)	
MECHANICAL CHARACTERISTICS	Weight ²⁾	14g (0.030lb)	
	Retention Spring separating force	≥20N	
	Mounting Screw torque max.	1.5Nm	
	Mechanical Operations	1500 mating cycles	
	Fastening A Type Connectors ³⁾ Fastening B Type Connectors ³⁾	Self-Tapping PT screw with thread 2.9 x 1.06 and of Tri-rondular configuration Self-Tapping screw M2.5	
MATERIALS	Connector Flange - B-Type Flange Finish - B-Type	Diecast Zinc Alloy Nickel or Black	
	Insulators	PA6.6+25% glass fibre reinforced, UL94V-0	UL94HB
	Male Contact Material	Brass	
	Male Contact Plating	0.0762μm (3μ") gold over 0.762μm (30μ") nickel	
	Female Contact Material	Bronze	
	Female Contact Plating	0.0762μm (3μ") gold over 0.762μm (30μ") nickel	
	Latch lock and Spring	Spring Steel	
	Ground element	Spring Steel	

¹⁾ Not suitable for domestic applications above 50V

²⁾ Approximate weight only, does not include packaging. Please contact us for exact weight for shipping purposes.

³⁾ Refer to page 132

AC SERIES A AND B TYPE CHASSIS PCB FOOTPRINTS STRAIGHT (V) - CONNECTOR SIDE OF PCB

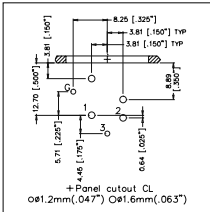

**AC3FAH2
AC3FBH2
AC3FBHB2**

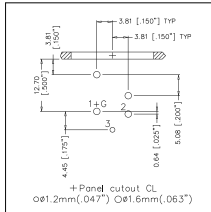

**AC3FAH1
AC3FAH3
AC3FBH1
AC3FBHB1
AC3FBH3**

**AC3FBHB3
AC3FAH
AC3FBH
AC3FBHB**

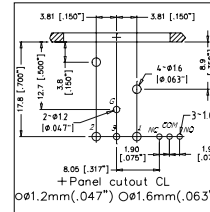

AC3MAH4SWB

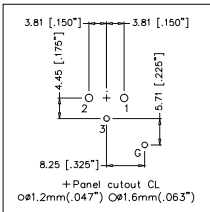

**AC3FAV2
AC3FBV2
AC3FBVB2**

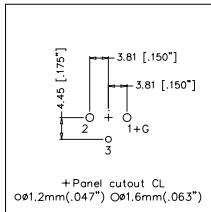

**AC3FAV1
AC3FAV3
AC3FBV1
AC3FBVB1
AC3FBV3**

**AC3FBVB3
AC3FAV
AC3FBV
AC3FBVB**

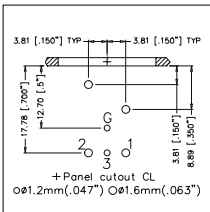

**AC3MAH2
AC3MAH4
AC3MBH2
AC3MBHB2**

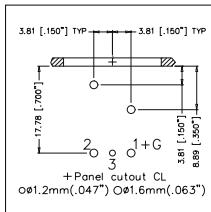

**AC3MAH1
AC3MAH3
AC3MBH1
AC3MBHB1
AC3MBH3
AC3MBHB3**

**AC3MAH
AC3MBH
AC3MBHB
AC3MBHL
AC3MBHBL**

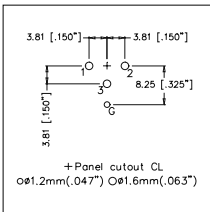

**AC3MAV2
AC3MAV4
AC3MBV2
AC3MBVB2**

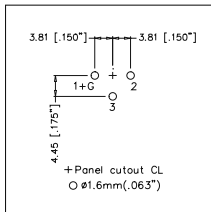

**AC3MAV1
AC3MAV3
AC3MBV1
AC3MBVB1
AC3MBV3
AC3MBVB3**

**AC3MBVB3
AC3MAV
AC3MBV
AC3MBVB**

AC SERIES 5 PIN PCB FOOTPRINTS STRAIGHT (V) - CONNECTOR SIDE OF PCB

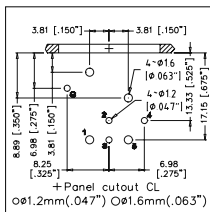

AC5FAH

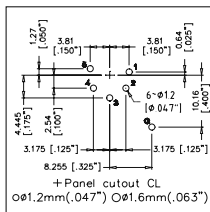

AC5FAV

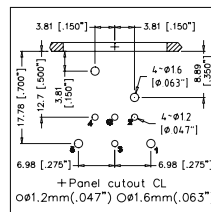

AC5MAH

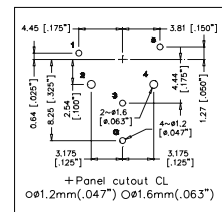

AC5MAV

AC SERIES A AND B TYPE CHASSIS PANEL CUTOUT DIMENSIONS - FRONT VIEW

A TYPE

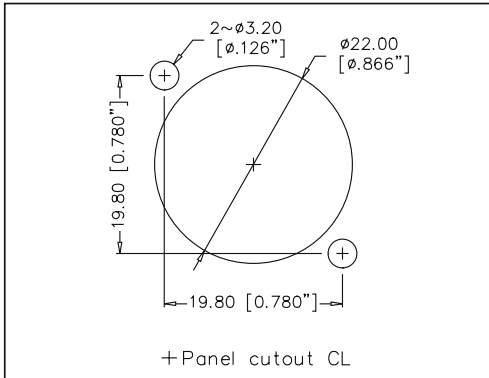

B TYPE

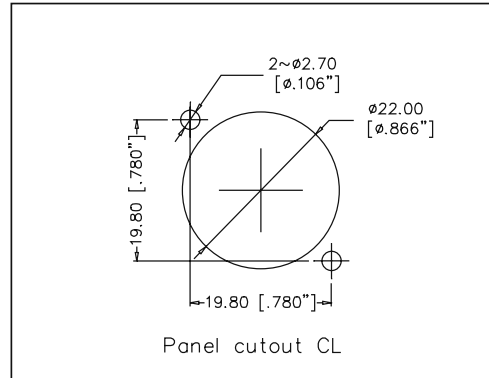

A AND B
TYPE MALE
MOUNTING
PITCH

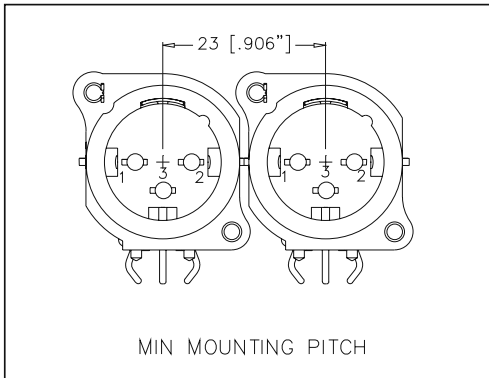

A AND
B TYPE
FEMALE
MOUNTING
PITCH

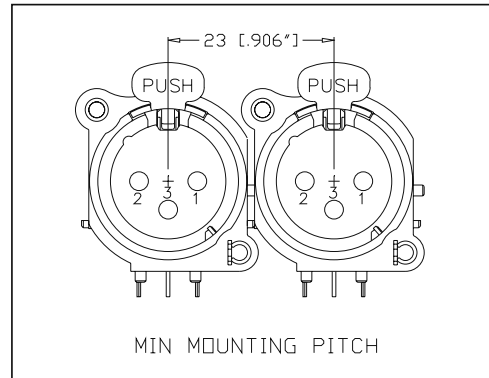

AC3FA/BH/V SCHEMATIC CHART

AC3FA/BH/V3-AU
AC3FA/BH/VL3-AU

AC3FA/BH/V2-AU
AC3FA/BH/VL2-AU

AC3FA/BH/V1-AU
AC3FA/BH/VL1-AU

AC3FA/BH/V-AU
AC3FA/BH/VL-AU

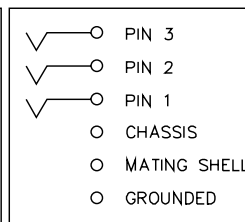
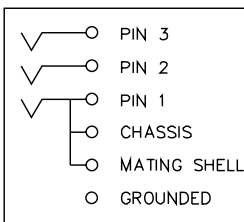
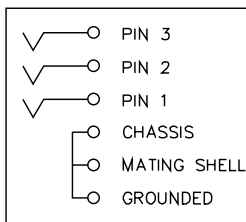
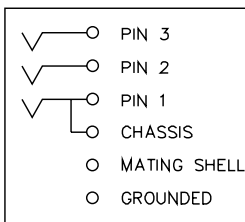

AC3MA/BH/V3-AU
AC3MA/BH/VL3-AU

AC3MA/BH/V2/4-AU
AC3MA/BH/VL2/4-AU

AC3MA/BH/V1-AU
AC3MA/BH/VL1-AU

AC3MA/BH/V-AU
AC3MA/BH/VL-AU

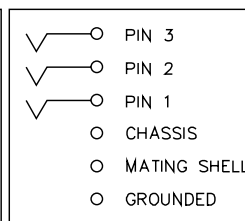
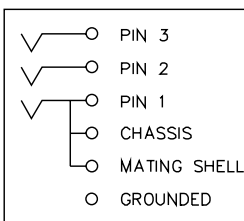
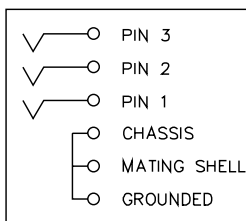
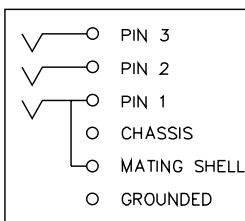



AC SERIES DUAL 1/4" (6.35mm) / XLR

The AC Series C type chassis receptacles feature two connectors in the one space saving housing. A combined XLR female receptacle together with a 6.35mm (1/4") phone jack give the designer more flexibility ensuring premium board space is saved. The new low profile high density C type offers a 15% space saving over the traditional C type. Various configurations are available in either stereo or mono layouts with Vertical, Horizontal Printed Circuit Board or Solder contacts.

Features

- Standard or low profile / high density shell design
- Two connectors in the one housing.
- Industry standard PCB footprint layout on standard C type.
- Vertical or Horizontal PCB mounting.
- Bulk packed.
- Positive latch lock system (XLR).

Options

- Solder contacts
- Vertical PCB contacts
- Horizontal PCB contacts
- Bulk Packaging
- Overmoldable connector housing

Ordering Codes

We have listed the more common ordering codes in each section. For further options please refer to the part number breakdown charts. Please contact us if you need any further assistance.

Simple steps to guide you in using this catalogue

- 1) Identify the product group listed in Contents on page 1 and go directly to that page number.
- 2) Each product group cover page then details information and options available.
- 3) Refer to the product detail pages and identify the product you require pictorially.
- 4) Read the product description column for the products standard features.
- 5) Use variations column to determine your choice.
- 6) Identify part number.
- 7) In the event the particular option you require is not listed please refer to the part number breakdown page at the end of each section.
- 8) Please contact us directly if you have any further problems.

Amphenol

AC SERIES CHASSIS CONNECTORS

C - TYPE LOW PROFILE DUAL JACK / XLR CONNECTORS



Features:

- Two connectors in the one housing.
- Low profile design offers a 15% space saving over the traditional design.
- Vertical or Horizontal PCB mounting.
- Bulk packed in trays, 100 to a box as standard.
- Positive latch lock system (XLR).

Part Number Breakdown: page 56

Specifications: page 58

PCB Footprints: page 57

Recommended Fastener: page 137

PRODUCT - FIGURE	DRAWING	Dimensions in mm (inches)	DESCRIPTION	VARIATIONS	PART NUMBER
			Low Profile XLR 3 pole female receptacle with 1/4" stereo jack without switching contact, Horizontal PCB mount, Bulk Pack	Latching	ACJC6AH BULK
			Low Profile XLR 3 pole female receptacle with 1/4" stereo jack without switching contact, Horizontal PCB mount, Bulk Pack	Non-latching, Retention Spring	ACJC6AHL BULK
			Low Profile XLR 3 pole female receptacle with 1/4" stereo jack without switching contact, Vertical PCB mount, Bulk Pack	Latching	ACJC6AV BULK
			Low Profile XLR 3 pole female receptacle with 1/4" stereo jack without switching contact, Vertical PCB mount, Bulk Pack	Non-latching, Retention Spring	ACJC6AVL BULK
			Low Profile XLR 3 pole female receptacle with 1/4" switching stereo jack, Horizontal PCB mount, Bulk Pack	Latching	ACJC9AH BULK
			Low Profile XLR 3 pole female receptacle with 1/4" switching stereo jack, Horizontal PCB mount, Bulk Pack	Non-latching, Retention Spring	ACJC9AHL BULK



Amphenol

AC SERIES CHASSIS CONNECTORS

THERMOPLASTIC C TYPE SERIES

PRODUCT - FIGURE	DRAWING	Dimensions in mm (inches)	DESCRIPTION	VARIATIONS	PART NUMBER
			Low Profile XLR 3 pole female receptacle with 1/4" switching stereo jack, Vertical PCB mount, Bulk Pack	Latching	ACJC9AV BULK
			Low Profile XLR 3 pole female receptacle with 1/4" switching stereo jack, Vertical PCB mount, Bulk Pack	Non-latching, Retention Spring	ACJC9AVL BULK
			Low Profile XLR 3 pole female receptacle with 1/4" switching stereo jack and switching ground contact, Horizontal PCB mount, Bulk Pack	Latching	ACJC10AH BULK
			Low Profile XLR 3 pole female receptacle with 1/4" switching stereo jack and switching ground contact, Horizontal PCB mount, Bulk Pack	Non-latching, Retention Spring	ACJC10AHL BULK
			Low Profile XLR 3 pole female receptacle with 1/4" switching stereo jack and switching ground contact, Vertical PCB mount, Bulk Pack	Latching	ACJC10AV BULK
			Low Profile XLR 3 pole female receptacle with 1/4" switching stereo jack and switching ground contact, Vertical PCB mount, Bulk Pack	Non-latching, Retention Spring	ACJC10AVL BULK

C - TYPE DUAL JACK / XLR CONNECTORS

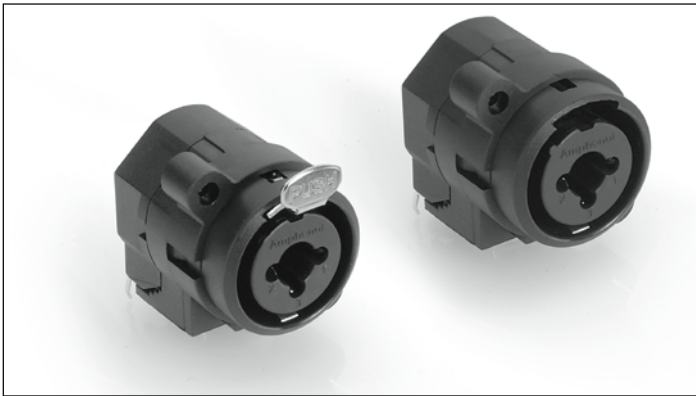

Features:

- Two connectors in the one housing.
- Space saving design.
- Industry standard PCB footprint layout.
- Vertical or Horizontal PCB mounting.
- Bulk packed in trays, 100 to a box as standard.
- Positive latch lock system (XLR).

Part Number Breakdown: page 56











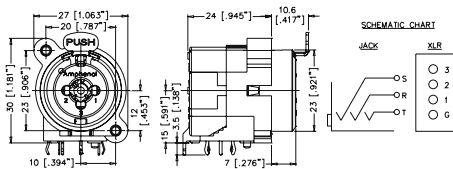

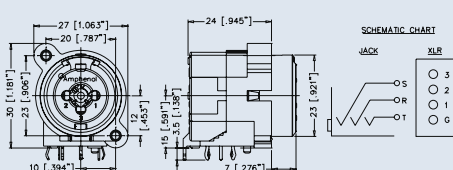

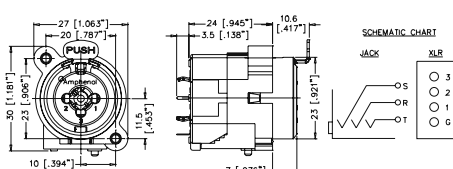
Specifications: page 58

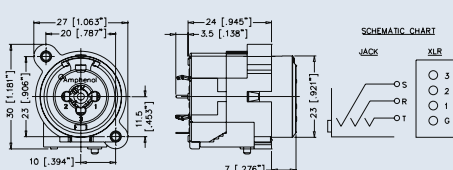
PCB Footprints: page 57

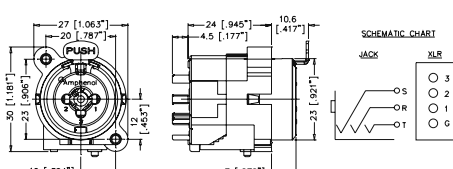
Recommended Fastener: page 137

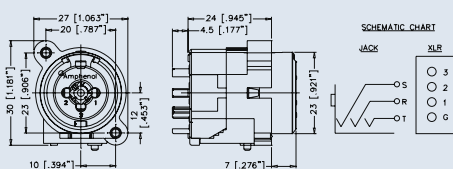

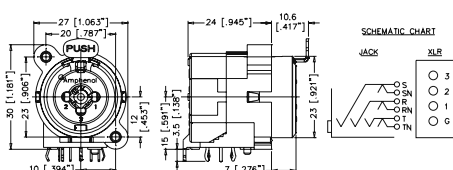

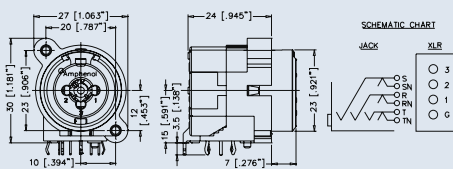
PRODUCT - FIGURE	DRAWING	Dimensions in mm (inches)	DESCRIPTION	VARIATIONS	PART NUMBER
		27 [1.063"], 20 [0.787"], 30 [1.181"], 23 [0.906"], 10 [.394"], 24 [.945"], 10.6 [.417"], 12 [.472"], 7 [.276"], 23 [.921"]	XLR 3 pole female receptacle with 1/4" mono jack without switching contact, Horizontal PCB mount, Bulk Pack	Latching	ACJC5H BULK
		27 [1.063"], 20 [0.787"], 30 [1.181"], 23 [0.906"], 10 [.394"], 24 [.945"], 10.6 [.417"], 12 [.472"], 7 [.276"], 23 [.921"]	XLR 3 pole female receptacle with 1/4" mono jack without switching contact, Horizontal PCB mount, Bulk Pack	Non-latching, Retention Spring	ACJC5HL BULK
		27 [1.063"], 20 [0.787"], 30 [1.181"], 23 [0.906"], 10 [.394"], 24 [.945"], 5.5 [0.217"], 10.6 [.417"], 12 [.472"], 7 [.276"], 23 [.921"]	XLR 3 pole female receptacle with 1/4" mono jack without switching contact, Vertical PCB mount, Bulk Pack	Latching	ACJC5V BULK
		27 [1.063"], 20 [0.787"], 30 [1.181"], 23 [0.906"], 10 [.394"], 24 [.945"], 5.5 [0.217"], 11.5 [.453"], 7 [.276"], 23 [.921"]	XLR 3 pole female receptacle with 1/4" mono jack without switching contact, Vertical PCB mount, Bulk Pack	Non-latching, Retention Spring	ACJC5VL BULK
		27 [1.063"], 20 [0.787"], 30 [1.181"], 23 [0.906"], 10 [.394"], 24 [.945"], 4.5 [0.177"], 10.6 [.417"], 12 [.472"], 7 [.276"], 23 [.921"]	XLR 3 pole female receptacle with 1/4" mono jack without switching contact, Solder Contacts, Bulk Pack	Latching	ACJC5S BULK
		27 [1.063"], 20 [0.787"], 30 [1.181"], 23 [0.906"], 10 [.394"], 24 [.945"], 4.5 [0.177"], 12 [.472"], 7 [.276"], 23 [.921"]	XLR 3 pole female receptacle with 1/4" mono jack without switching contact, Solder Contacts, Bulk Pack	Non-latching, Retention Spring	ACJC5SL BULK

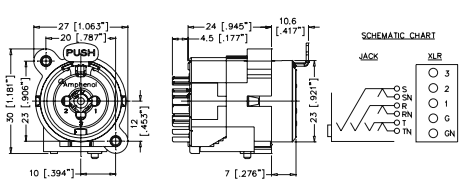

PRODUCT - FIGURE	DRAWING	Dimensions in mm (inches)	DESCRIPTION	VARIATIONS	PART NUMBER
			XLR 3 pole female receptacle with 1/4" stereo jack without switching contact, Horizontal PCB mount, Bulk Pack	Latching	ACJC6H BULK
			XLR 3 pole female receptacle with 1/4" stereo jack without switching contact, Horizontal PCB mount, Bulk Pack	Non-latching, Retention Spring	ACJC6HL BULK
			XLR 3 pole female receptacle with 1/4" stereo jack without switching contact, Vertical PCB mount, Bulk Pack	Latching	ACJC6V BULK
			XLR 3 pole female receptacle with 1/4" stereo jack without switching contact, Vertical PCB mount, Bulk Pack	Non-latching, Retention Spring	ACJC6VL BULK
			XLR 3 pole female receptacle with 1/4" stereo jack without switching contact, Solder Contacts, Bulk Pack	Latching	ACJC6S BULK
			XLR 3 pole female receptacle with 1/4" stereo jack without switching contact, Solder Contacts, Bulk Pack	Non-latching, Retention Spring	ACJC6SL BULK
			XLR 3 pole female receptacle with 1/4" switching stereo jack, Horizontal PCB mount, Bulk Pack	Latching	ACJC9H BULK
			XLR 3 pole female receptacle with 1/4" switching stereo jack, Horizontal PCB mount, Bulk Pack	Non-latching, Retention Spring	ACJC9HL BULK

PRODUCT - FIGURE	DRAWING	DESCRIPTION	VARIATIONS	PART NUMBER
	<p>Dimensions in mm (inches)</p> <p>27 [1.063"] 20 [0.787"] 30 [1.181"] 23 [0.906"] 10 [.394"] 12 [.472"] 24 [.945"] 3.5 [.138"] 10.6 [.417"] 7 [.276"] 23 [.921"]</p> <p>SCHEMATIC CHART</p> <p>JACK XLR</p> <p>3 2 1 G</p>	XLR 3 pole female receptacle with 1/4" switching stereo jack, Vertical PCB mount, Bulk Pack	Latching	ACJC9V BULK
	<p>Dimensions in mm (inches)</p> <p>27 [1.063"] 20 [0.787"] 30 [1.181"] 23 [0.906"] 10 [.394"] 12 [.472"] 24 [.945"] 3.5 [.138"] 7 [.276"] 23 [.921"]</p> <p>SCHEMATIC CHART</p> <p>JACK XLR</p> <p>3 2 1 G</p>	XLR 3 pole female receptacle with 1/4" switching stereo jack, Vertical PCB mount, Bulk Pack	Non-latching, Retention Spring	ACJC9VL BULK
	<p>Dimensions in mm (inches)</p> <p>27 [1.063"] 20 [0.787"] 30 [1.181"] 23 [0.906"] 10 [.394"] 12 [.472"] 24 [.945"] 4.5 [.177"] 10.6 [.417"] 7 [.276"] 23 [.921"]</p> <p>SCHEMATIC CHART</p> <p>JACK XLR</p> <p>3 2 1 G</p>	XLR 3 pole female receptacle with 1/4" switching stereo jack, Solder Contacts, Bulk Pack	Latching	ACJC9S BULK
	<p>Dimensions in mm (inches)</p> <p>27 [1.063"] 20 [0.787"] 30 [1.181"] 23 [0.906"] 10 [.394"] 12 [.472"] 24 [.945"] 4.5 [.177"] 7 [.276"] 23 [.921"]</p> <p>SCHEMATIC CHART</p> <p>JACK XLR</p> <p>3 2 1 G</p>	XLR 3 pole female receptacle with 1/4" switching stereo jack, Solder Contacts, Bulk Pack	Non-latching, Retention Spring	ACJC9SL BULK
	<p>Dimensions in mm (inches)</p> <p>27 [1.063"] 20 [0.787"] 30 [1.181"] 23 [0.906"] 10 [.394"] 12 [.472"] 24 [.945"] 3.5 [.138"] 10.6 [.417"] 7 [.276"] 23 [.921"] 15 [.591"]</p> <p>SCHEMATIC CHART</p> <p>JACK XLR</p> <p>3 2 1 G GN</p>	XLR 3 pole female receptacle with 1/4" switching stereo jack and switching ground contact, Horizontal PCB mount, Bulk Pack	Latching	ACJC10H BULK
	<p>Dimensions in mm (inches)</p> <p>27 [1.063"] 20 [0.787"] 30 [1.181"] 23 [0.906"] 10 [.394"] 12 [.472"] 24 [.945"] 3.5 [.138"] 7 [.276"] 23 [.921"] 15 [.591"]</p> <p>SCHEMATIC CHART</p> <p>JACK XLR</p> <p>3 2 1 G GN</p>	XLR 3 pole female receptacle with 1/4" switching stereo jack and switching ground contact, Horizontal PCB mount, Bulk Pack	Non-latching, Retention Spring	ACJC10HL BULK
	<p>Dimensions in mm (inches)</p> <p>27 [1.063"] 20 [0.787"] 30 [1.181"] 23 [0.906"] 10 [.394"] 12 [.472"] 24 [.945"] 3.5 [.138"] 10.6 [.417"] 7 [.276"] 23 [.921"]</p> <p>SCHEMATIC CHART</p> <p>JACK XLR</p> <p>3 2 1 G GN</p>	XLR 3 pole female receptacle with 1/4" switching stereo jack and switching ground contact, Vertical PCB mount, Bulk Pack	Latching	ACJC10V BULK
	<p>Dimensions in mm (inches)</p> <p>27 [1.063"] 20 [0.787"] 30 [1.181"] 23 [0.906"] 10 [.394"] 12 [.472"] 24 [.945"] 4.5 [.177"] 7 [.276"] 23 [.921"]</p> <p>SCHEMATIC CHART</p> <p>JACK XLR</p> <p>3 2 1 G GN</p>	XLR 3 pole female receptacle with 1/4" switching stereo jack and switching ground contact, Vertical PCB mount, Bulk Pack	Non-latching, Retention Spring	ACJC10VL BULK

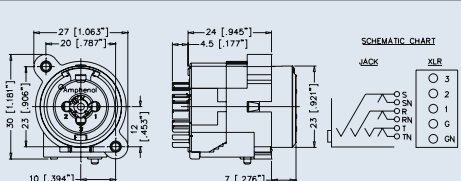

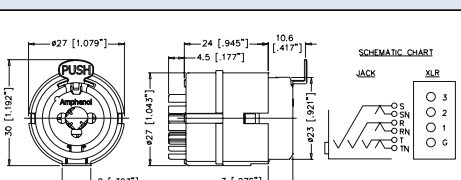
PRODUCT - FIGURE	DRAWING	Dimensions in mm (inches)	DESCRIPTION	VARIATIONS	PART NUMBER
			XLR 3 pole female receptacle with 1/4" switching stereo jack and switching ground contact, Solder Contacts, Bulk Pack	Latching	ACJC10S BULK
			XLR 3 pole female receptacle with 1/4" switching stereo jack and switching ground contact, Solder Contacts, Bulk Pack	Non-latching, Retention Spring	ACJC10SL BULK
			XLR 3 pole female receptacle with 1/4" jack, Solder Contacts, Overmoldable Connector Housing	Latching and Non-latching options available	ACJC9M BULK

PART NUMBER BREAKDOWN

AC SERIES THERMOPLASTIC C TYPE

E. G. **ACJC5HL BULK**
AC (Series Prefix), **JC** Jack/Connector XLR, **5** Mono, **H**orizontal Printed Circuit Board, **L**atchless, **BULK** Packaged.

SERIES PREFIX	AC	=	Series Prefix
CONNECTOR TYPE	JC	=	Jack / Connector XLR
CONTACT OPTIONS	5	=	Mono, Non Switching, XLR Grounded
	6	=	Stereo, Non Switching, XLR Grounded
	9	=	Stereo, Switching, XLR Grounded
	10	=	Stereo, Switching, XLR with Ground Switch
HOUSING TYPE	Blank	=	Standard
	A	=	Low Profile / High Density
	M	=	Overmold Housing
CONTACT TYPE	V	=	Vertical Printed Circuit Board
	H	=	Horizontal Printed Circuit Board
	S	=	Solder Contacts
LOCKING MECHANISM	Blank	=	Latching
	L	=	Latchless
PACKAGING	Blank	=	Individual Bags
	BULK	=	Bulk Packed

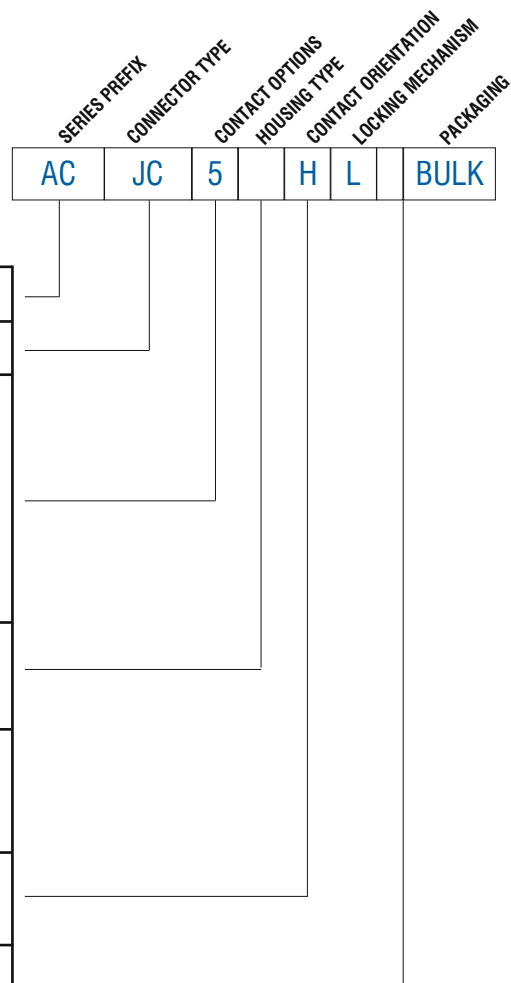

AC SERIES C TYPE SERIES

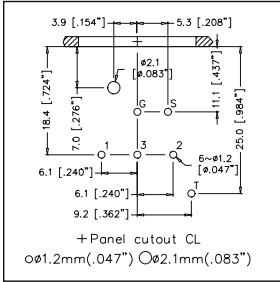

ACJC5H & ACJC5HL

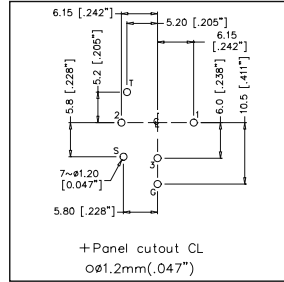

ACJC5V & ACJC5VL

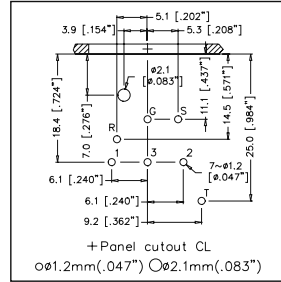

ACJC6H & ACJC6HL

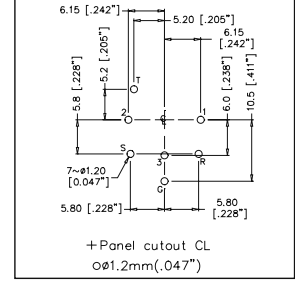

ACJC6V & ACJC6VL

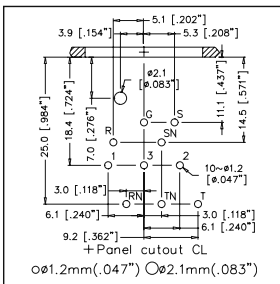

ACJC9H & ACJC9HL

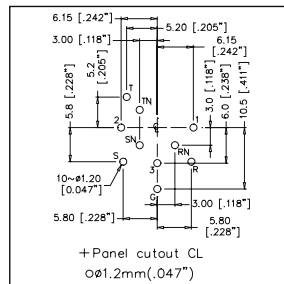

ACJC9V & ACJC9VL

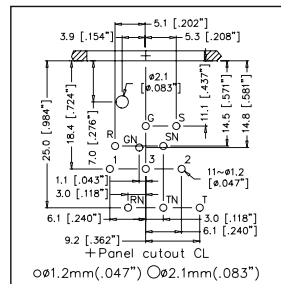

ACJC10H & ACJC10HL

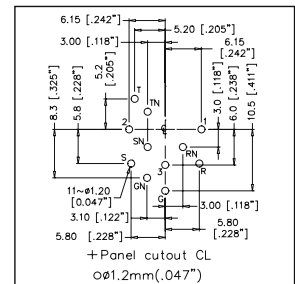

ACJC10V & ACJC10VL

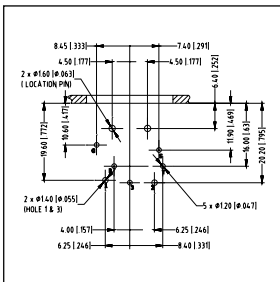

ACJC6AH & ACJC6AHL

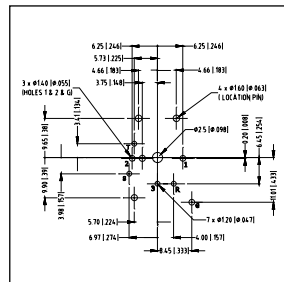

ACJC6AV & ACJC6AVL

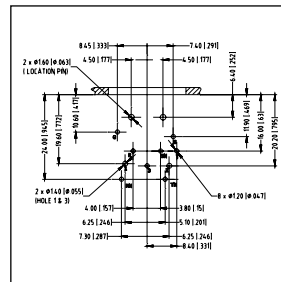

ACJC9AH & ACJC9AHL

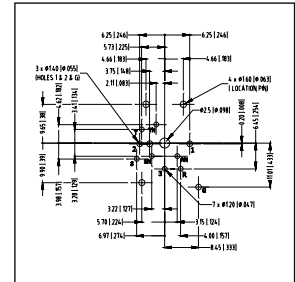

ACJC9AV & ACJC9AVL

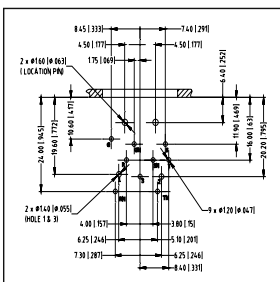

ACJC10AH & ACJC10AHL

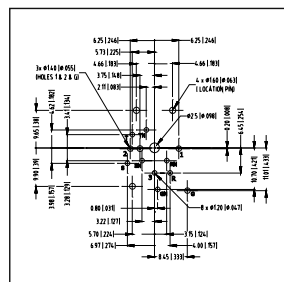

ACJC10AV & ACJC10AVL

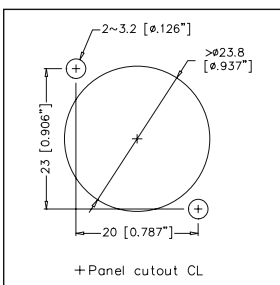

C TYPE PANEL CUTOUT

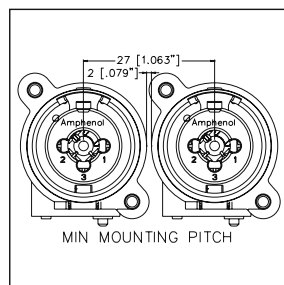

C TYPE MOUNTING PITCH

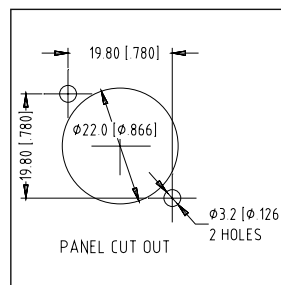

C TYPE LOW PROFILE PANEL CUTOUT

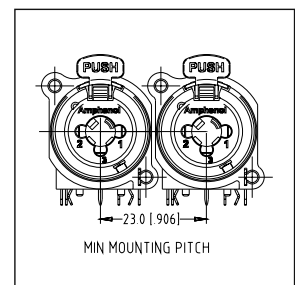

C TYPE LOW PROFILE MOUNTING PITCH



STANDARD DATA C TYPE CHASSIS RECEPTACLES

		VALUE	
		LOW PROFILE TYPE	STANDARD C TYPE
GENERAL CHARACTERISTICS	Number of contacts	5, 6, 9 or 10	
	Termination	Printed Circuit Board (PCB)	Printed Circuit Board (PCB) or Solder Bucket
	Flammability	UL 94HB	
	Environmental	Complies with EU RoHS 2 Directive 2011/65/EU	
ELECTRICAL CHARACTERISTICS	Service Voltage RMS	50V	
	Test Voltage AC RMS	1500V	
	Current carrying capacity	7.5A	
	Typical Contact Resistance	≤50mΩ	
	Insulation Resistance (initial)	> 0.5GΩ	
	Insulation Resistance (after damp heat test)	> 0.2GΩ	
CLIMATIC CHARACTERISTICS	Protection Class	IP40	
	Operating Temperature	-25 °C to +70 °C	
MECHANICAL CHARACTERISTICS	Weight**	9.2g (0.02lb)	14g (0.030lb)
	Retention Spring separating force	≥20N	
	Mounting Screw torque max.	1.5Nm	
	Mechanical Operations	1500 mating cycles	
	Fastening***	Self-Tapping PT screw with thread 2.9 x 1.06 and of Tri-rondular configuration	
MATERIALS	Connector Shell	PA6.6 + 30% glass fibre reinforced, UL94HB	PA6.6 + 20% glass fibre reinforced, UL94HB
	Shell Finish		Black
	Insulators	PA6.6 glass fibre reinforced, UL94HB	PA6.6 + 20% glass fibre reinforced, UL94HB
	XLR Contact		
	Material	Bronze	
	Plating	Gold over Nickel plated	
	Jack Contact		
	Material	Bronze	Brass
Plating	Gold over Nickel plated	Silver over Copper plated	
Latch lock and Spring	Nickel Plated		
Ground element	Nickel Plated	Silver over Copper plated	

**Approximate weight in grams not including packaging. Please contact us for exact weight for shipping purposes.

***Refer to page 137

Rev 6 - 03/2013



This receptacle is manufactured from glass filled UL94V-0 PBT Resin, and provides a lower cost alternative to the 'Z' series metal shell. A positive latch lock system secures the mating cable connector. Manufactured to comply with IEC 268-12 and AES 14-1992 standards. CSA File Number 68598

Features

- Thermoplastic Shell.
- The "D" size housing can be either front or rear mounted using the same panel cutout.
- A leading first mate last break socket contact is standard on all female connectors (Pin 1).
- Solder cup or Insulation Displacement Contact (IDC) as well as Vertical or Horizontal PCB versions are available.
- Latching and Non-latching versions available.
- Available in 3 contact arrangements only.
- Compatible with all other XLR brands.

Options

- Solder Bucket termination
- Insulation Displacement Contacts (IDC)
- Vertical PCB contacts
- Horizontal PCB contacts
- Bulk Packaging
- Single Bag packs
- Cost effective stamped contacts
- Latching or Non-latching.

Ordering Codes

We have listed the more common ordering codes in each section. For further options please refer to the part number breakdown charts. Please contact us if you need any further assistance.

AC SERIES XLR THERMOPLASTIC CHASSIS MOUNT CONNECTORS

Simple steps to guide you in using this catalogue

- 1) Identify the product group listed in Contents on page 1 and go directly to that page number.
- 2) Each product group cover page then details information and options available.
- 3) Refer to the product detail pages and identify the product you require pictorially.
- 4) Read the product description column for the products standard features.
- 5) Use variations column to determine your choice.
- 6) Identify part number.
- 7) In the event the particular option you require is not listed please refer to the part number breakdown page at the end of each section.
- 8) Please contact us directly if you have any further problems.





Features:

- Thermoplastic shell.
- D type Flange.
- Solder Bucket connections.
- Vertical or Horizontal PCB mounting.
- Stamped contacts.
- Leading first mate last break socket contact.
- Positive latch lock system.
- Coloured housings available as specials.

Options: Solder Buckets, Vertical or Horizontal PCB, Bulk Pack, Latching or Non-latching, Gold Plated Contacts, Machined Contacts.

**Specifications: 64
PCB Footprints: 65**

**Part Number Breakdown: 61
Panel Cutouts: 65**

PRODUCT - FIGURE	DRAWING	Dimensions in mm (inches)	DESCRIPTION	VARIATIONS	PART NUMBER
			XLR 3 pole male, D Flange, Thermoplastic shell, Solder Buckets	Standard Bulk Pack Non-Latching Non-Latching Bulk	AC3MDP AC3MDP BULK AC3MDPL AC3MDPL BULK
			XLR 3 pole male, D Flange, Airtight Thermoplastic shell, Machined Contacts, Solder Buckets	Standard Bulk Pack Non-Latching Non-Latching Bulk	AC3MMDP AC3MMDP BULK AC3MMDPL AC3MMDPL BULK
			XLR 3 pole female, D Flange, Thermoplastic shell, Solder Buckets	Standard Bulk Pack Non-Latching Non-Latching Bulk	AC3FDP AC3FDP BULK AC3FDPL AC3FDPL BULK
			XLR 3 pole male, D Flange, Thermoplastic shell, Horizontal PCB mount	Standard Bulk Pack Non-Latching Non-Latching Bulk	AC3MDPH AC3MDPH BULK AC3MDPHL AC3MDPHL BULK
			XLR 3 pole female, D Flange, Thermoplastic shell, Horizontal PCB mount	Standard Bulk Pack Non-Latching Non-Latching Bulk	AC3FDPH AC3FDPH BULK AC3FDPHL AC3FDPHL BULK
			XLR 3 pole male, D Flange, Thermoplastic shell, Vertical PCB mount	Standard Bulk Pack Non-Latching Non-Latching Bulk	AC3MDPV AC3MDPV BULK AC3MDPVL AC3MDPVL BULK
			XLR 3 pole female, D Flange, Thermoplastic shell, Vertical PCB mount	Standard Bulk Pack Non-Latching Non-Latching Bulk	AC3FDPV AC3FDPV BULK AC3FDPVL AC3FDPVL BULK

PART NUMBER BREAKDOWN

THERMOPLASTIC D TYPE FLANGE

E. G. **AC3MDPVL-AU BULK**
AC (Series Prefix), **3** contacts, **Male**, **D** (Small Shell), **P** (Thermoplastic Chassis series)
 Vertical Printed Circuit Board, **Latchless** - **AU** (Gold Plated Contacts), **Bulk** Packaged.

SERIES PREFIX	AC	=	Series Prefix
CONTACT LAYOUT	3	=	3 Contacts only
GENDER	F	=	Female Socket Contacts
	M	=	Male Pin Contacts
	MM	=	Male Machined Contacts
SHELL STYLE	D	=	Small Shell
SHELL SERIES	P	=	Thermoplastic Chassis Series
TERMINATION	Blank	=	Solder Buckets
	V	=	Vertical Printed Circuit Board
	H	=	Horizontal Printed Circuit Board
LOCKING MECHANISM	Blank	=	Latching
	L	=	Latchless (Non-Latching)
CONTACT PLATING	Blank	=	Standard Plating (Silver or Tin - Refer to Standard Data.)
	AU	=	Gold Plated Contacts
PACKAGING	Blank	=	Individual Bags
	BULK	=	Bulk Packed

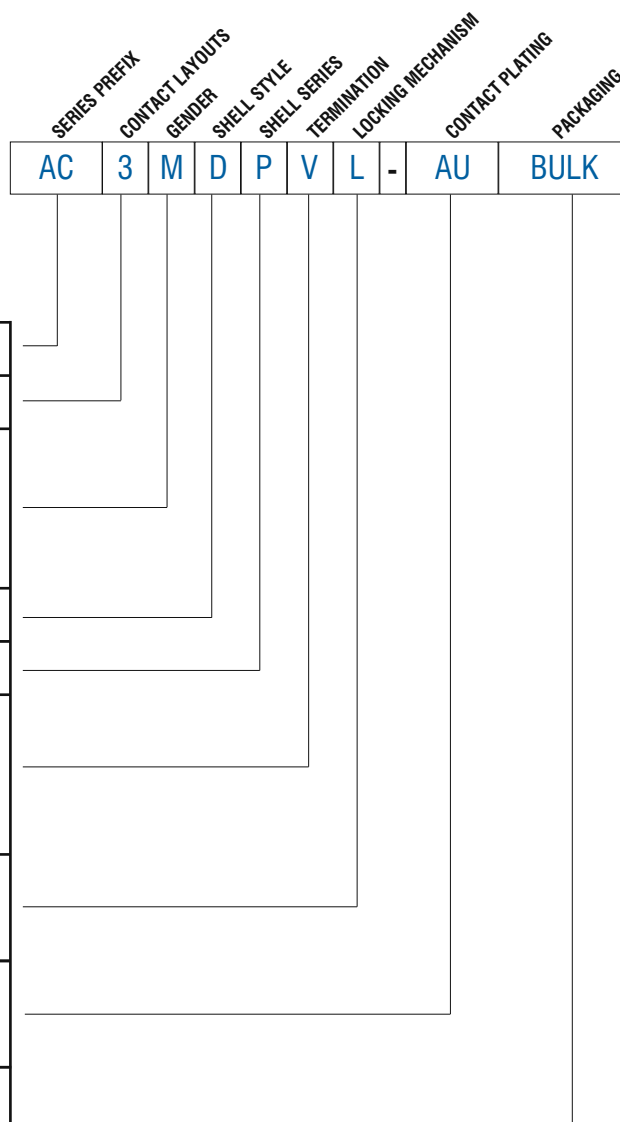

THERMOPLASTIC TYPE - IDC (SOLDERLESS)



The Insulation Displacement Contact (IDC) connector is ideal for Original Equipment Manufacturers and end users alike and offers an alternative to our standard solder connector. Connectors can be quickly and easily assembled without screws or a soldering iron – by hand. Labour savings of up to 60% in termination time can be achieved.

Recommended Cable Specifications: page 64

Features:

- Thermoplastic Shell.
- Optional “D”, “P” or Dual Housing flange sizes.
- Insulation Displacement Contacts (IDC)
- Stamped contacts.
- Leading first mate last break socket contact.
- Positive latch lock system.
- Coloured housings available as specials.

Options: Gold plated contacts, Bulk Pack, Latching or Non-latching
Part Number Breakdown: page 63 Specifications: page 64
Assembly Instructions: page 66 Panel Cutouts: page 65

PRODUCT - FIGURE	DRAWING	Dimensions in mm (inches)	DESCRIPTION	VARIATIONS	PART NUMBER
			XLR 3 pole male, D Flange, IDC contacts, Thermoplastic shell	Standard	AC3MDPI
				Bulk Pack	AC3MDPI BULK
				Non-Latching	AC3MDPIL
				Non-Latching Bulk	AC3MDPIL BULK
			XLR 3 pole female, D Flange, IDC contacts, Thermoplastic shell	Standard	AC3FDPI
				Bulk Pack	AC3FDPI BULK
				Non-Latching	AC3FDPIL
				Non-Latching Bulk	AC3FDPIL BULK
			XLR 3 pole male, Wide Flange, IDC contacts, Thermoplastic shell	Standard	AC3MPPI
				Bulk Pack	AC3MPPI BULK
				Non-Latching	AC3MPPI L
				Non-Latching Bulk	AC3MPPI L BULK
			XLR 3 pole female, Wide Flange, IDC contacts, Thermoplastic shell	Standard	AC3FPPI
				Bulk Pack	AC3FPPI BULK
				Non-Latching	AC3FPPI L
				Non-Latching Bulk	AC3FPPI L BULK



PART NUMBER BREAKDOWN

IDC D AND P THERMOPLASTIC CHASSIS TYPE

E. G. **AC3MDPIL-AU BULK**
AC (series prefix), **3** contacts, **Male**, **D** Flange, Plastic Shell, IDC, Latchless,
AU (Gold Plated Contacts), **Bulk** Packaged.

SERIES PREFIX	AC	=	Series Prefix
CONTACT LAYOUT	3	=	3 Contacts only
GENDER	F	=	Female Socket Contacts
	M	=	Male Pin Contacts
SHELL STYLE	D	=	D Flange
SHELL SERIES	P	=	Thermoplastic Chassis Series
TERMINATION	I	=	IDC Termination
LOCKING MECHANISM	Blank	=	Latching
	L	=	Latchless
CONTACT PLATING	Blank	=	Standard Plating (Silver or Tin - Refer to Standard Data.)
	AU	=	Gold Plated Contacts
PACKAGING	Blank	=	Individual Bags
	BULK	=	Bulk Packed

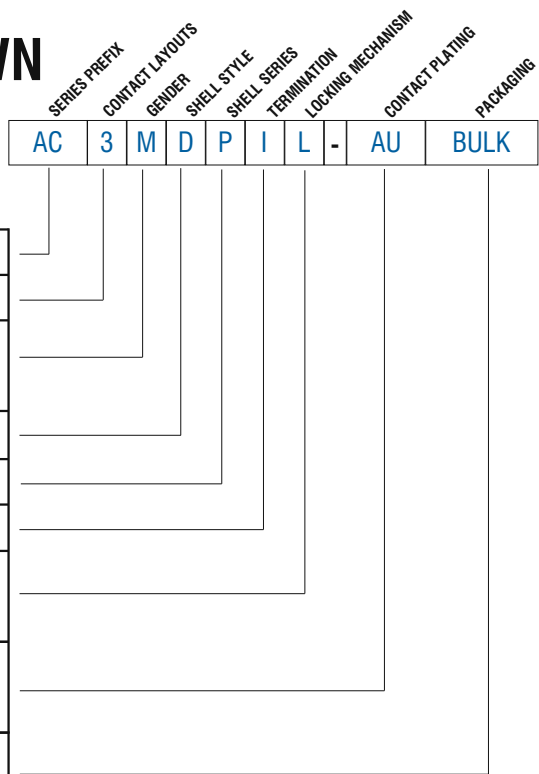

STANDARD DATA AC CHASSIS - THERMOPLASTIC

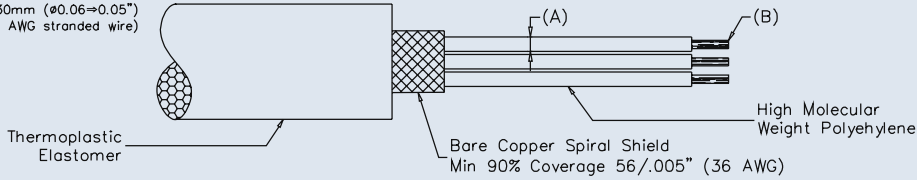
		VALUE
GENERAL CHARACTERISTICS	Number of contacts	3
	AC Series Contact Arrangements (Front view of pin inserts)	
	Termination	Solder / IDC / Printed Circuit Board (PCB)
	Wire Gauge - Stranded wire:	
	IDC	24AWG
	Solder	12AWG
	Printed Circuit Board (PCB)	N/A
	Flammability	UL94V-0
Environmental	Complies with EU RoHS 2 Directive 2011/65/EU	
ELECTRICAL CHARACTERISTICS	Service Voltage RMS	133V ¹⁾
	Test Voltage AC RMS	1400V
	Current carrying capacity:	
	IDC	1A
	Solder	15A
	Printed Circuit Board (PCB)	15A
	Typical Contact Resistance	≤3mΩ
	Insulation Resistance	≥1000MΩ
CLIMATIC CHARACTERISTICS	Protection Class	IP40
	Operating Temperature	-25 °C to +75 °C (-13°F to +167°F)
MECHANICAL CHARACTERISTICS	Weight ²⁾	14g - (0.030lb)
	Mechanical Operations	1000 mating cycles
MATERIALS	Connector Shell - Thermoplastic	Thermoplastic, ULV94V-0 Modified PPE Resin
	Shell Finish	Black, other colours available - contact factory
	Insulators	ULV94V-0 PBT Resin or Modified PPE Resin
	Male Contact	
	Stamped IDC-Material/Plating	Phosphor Bronze / Silver or Gold (optional)
	Stamped Solder and PCB-Material/Plating	Phosphor Bronze / Silver or Gold (optional)
Female Contact		
Stamped IDC-Material/Plating	Phosphor Bronze / Tin or Gold (optional)	
Stamped Solder and PCB-Material/Plating	Phosphor Bronze / Tin or Gold (optional)	
IDC RECOMMENDED CABLE DIMENSIONS	A - OD $\phi 1.50 \Rightarrow 1.30\text{mm}$ ($\phi 0.06 \Rightarrow 0.05''$) B - 16/.005" (24 AWG stranded wire)	
		Thermoplastic Elastomer Bare Copper Spiral Shield Min 90% Coverage 56/.005" (36 AWG) High Molecular Weight Polyethylene

¹⁾ Not suitable for domestic applications above 50V

²⁾ Approximate weight in grams does not include packaging. Please contact us for exact weight for shipping purposes.

AC SERIES RECEPTACLES THERMOPLASTIC

MOUNTING INFORMATION

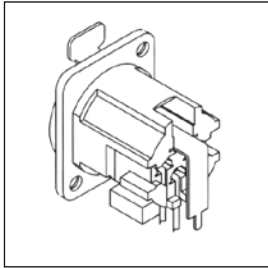

'D' SERIES
90° PCB (H)

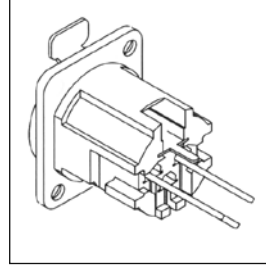
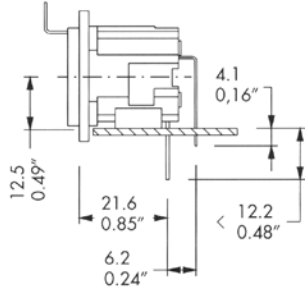

'D' SERIES
STRAIGHT PCB (V)

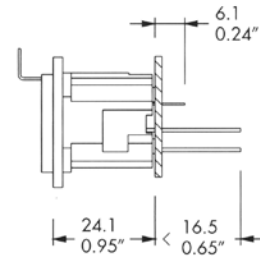

PCB FOOTPRINT - CONNECTOR SIDE OF PCB

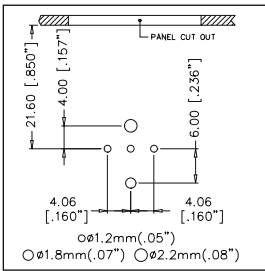

AC3FDPH

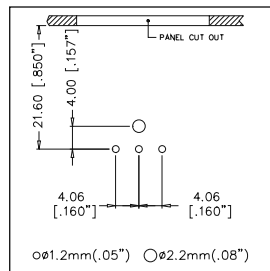

AC3MDPH

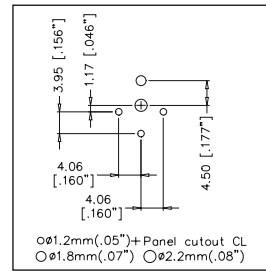

AC3FDPV

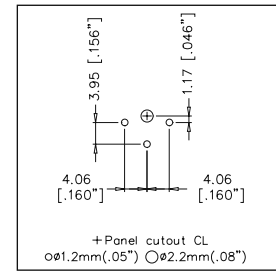

AC3MDPV

PANEL CUTOUT DIMENSIONS - FRONT VIEW

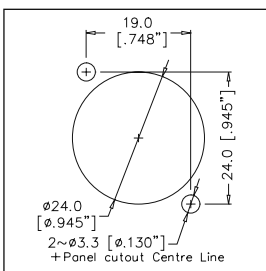

AC3FDP / AC3MDP



AC IDC SERIES CHASSIS ASSEMBLY INSTRUCTIONS

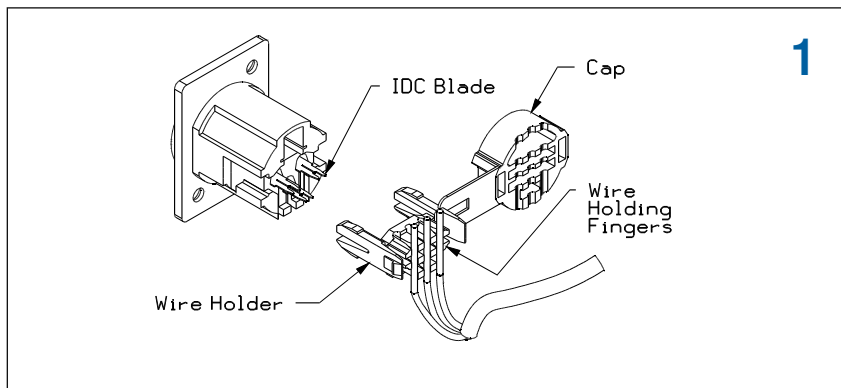

Lay the insulated conductors between the wire holding fingers. The fingers will retain the wire if it is inserted sufficiently.

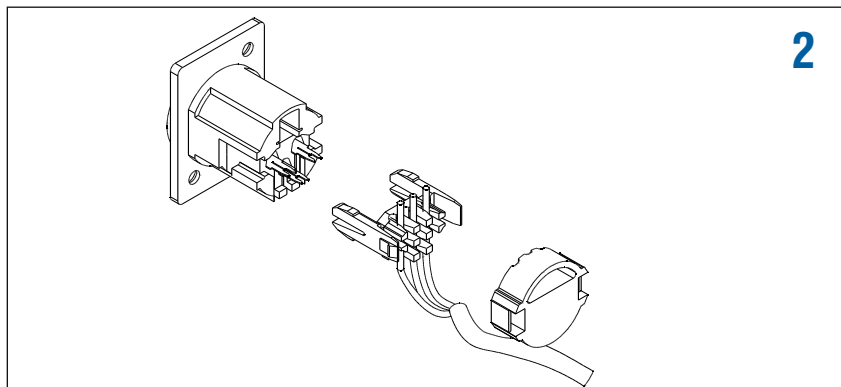

Break the strap off from the wire holder and the cap. Assemble the cap to the wire holder as shown. Push it home until the second snap operates.

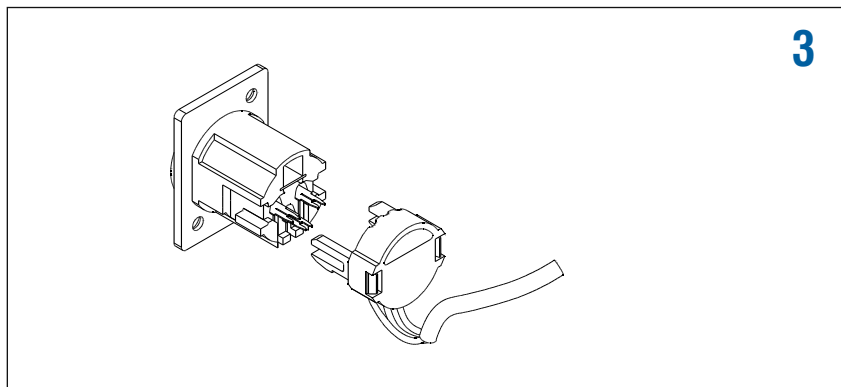

Align the wire holder and cap assembly with the slots down the side of the connector body. Push together, being careful not to damage the IDC blades through misalignment.

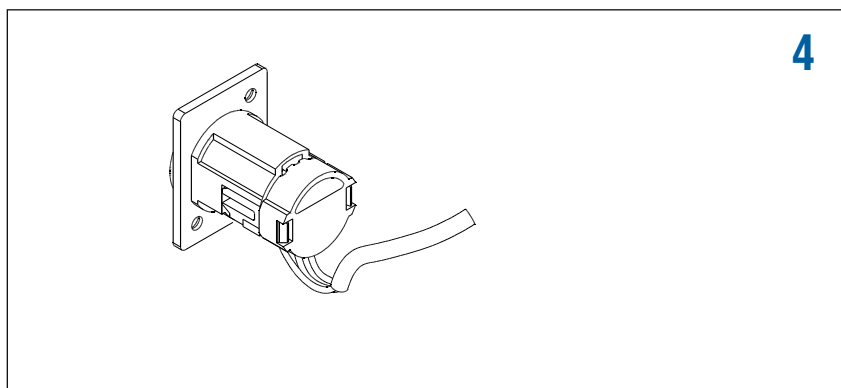

Ensure wire holder snaps into the body.



SP/EP/AP SERIES HIGH POWER / LOUDSPEAKER CONNECTORS

The SP Series are available in 2 or 4 pole chassis mount connectors. The durable thermoplastic housings are fitted with high power contacts to ensure optimal current carrying capacity. Completely intermatable with industry standard loudspeaker connections.

The EP Series incorporates a rugged zinc diecast shell to give it maximum durability when used in demanding situations. The EP cable connector cable flex relief design minimises cable bend stress at point of entry into the connector housing.

The AP Series Shell is manufactured from tough, durable thermoplastic, and ideal for fixed indoor installations. Both the EP and AP Series utilise the same contact and insulator components.

Features

- High current contacts for distortion free signal.
- Tough, durable zinc diecast shell for the EP series.
- Cost effective durable thermoplastic shell for the AP and SP series.
- EP series available in 3, 4, 5, 6 and 8 contact arrangements
- AP series available in 4, 5, 6, and 8 contact arrangements.
- SP series available in 2 and 4 contact arrangements.
- SP Series with overmolded cable support boot or PG gland with or without cable support strain relief.

- EP series cable clamp capable of supporting cables from 9mm (0.35") to 16mm (0.63") in diameter.

- Quick release, vibration resistant latch lock.

- AP & EP series are completely intermatable.

Options

- Solder termination / Tab or Printed Circuit Board versions, Screw Terminals (SP Series)
- Nickel Plated Zinc Alloy shell (EP/SP Series)
- Black finished Zinc Alloy shell (EP/SP Series)
- Precision machined contacts
- Thermoplastic shell (AP/SP Series)

Ordering Codes

We have listed the more common ordering codes in each section. Please contact us if you need any further assistance.

Simple steps to guide you in using this catalogue

- 1) Identify the product group listed in Contents on page 1 and go directly to that page number.
- 2) Each product group cover page then details information and options available.
- 3) Refer to the product detail pages and identify the product you require pictorially.
- 4) Read the product description column for the products standard features.
- 5) Use variations column to determine your choice.
- 6) Identify part number.
- 7) In the event the particular option you require is not listed please refer to the part number breakdown page at the end of each section.
- 8) Please contact us directly if you have any further problems.



SP SERIES LOUDSPEAKER CONNECTORS











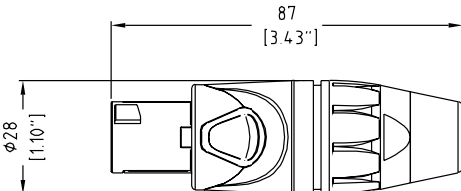

Amphenol's range of loudspeaker connectors have been further enhanced with the introduction of the SP Series. Designed to complement the popular EP/AP Series, we now offer a range of loudspeaker connectors to suit most applications. SP Series chassis connectors are available in industry standard PCB footprints with solder tabs. SP Series cable plugs are available with screw or solder terminals.

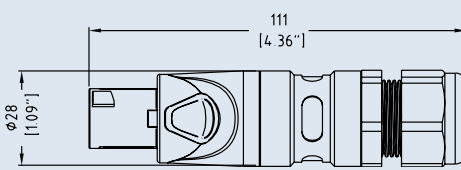
Features:

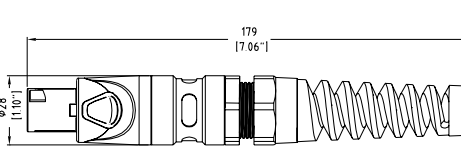
- Quick release, vibration resistant latch lock
- 2 or 4 pole
- Solder tabs, PCB Contacts, Solder or Screw Terminals
- Chuck type or PG Gland cable clamp
- Various mounting hole options
- 30A Current rating
- Thermoplastic or Metal housing (Cable Plugs)
- Industry standard mating

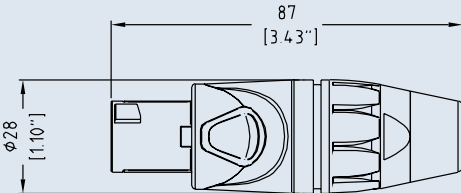
Part Number Breakdown: [page 72](#) **Specifications:** [page 75](#)
PCB Footprints: [page 74](#)

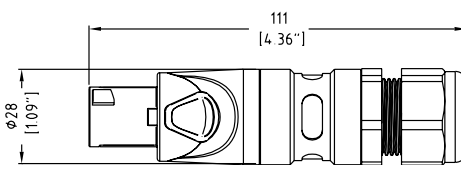

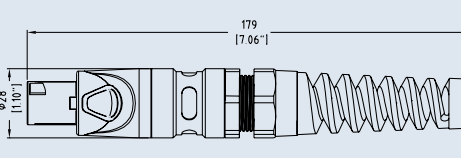



PRODUCT - FIGURE	DRAWING	Dimensions in mm (inches)	DESCRIPTION	CONTACT TYPE	SHELL COLOUR	PART NUMBER
			2 pole, Cable connector, Thermoplastic shell, Blue sleeve	Screw	Black	SP-2-F
				Solder	Black	SP-2-FS
			2 pole, Cable connector, Thermoplastic shell, Blue sleeve, PG Gland	Screw	Black	SP-2-FG
				Solder	Black	SP-2-FSG
			2 pole, Cable connector, Thermoplastic shell, Blue sleeve, PG Gland strain relief	Screw	Black	SP-2-FL
				Solder	Black	SP-2-FSL
			2 pole, Cable connector, Metal shell, Blue sleeve	Screw	Nickel	SP-2-FN
				Solder	Nickel	SP-2-FNS
				Screw	Black	SP-2-FB
				Solder	Black	SP-2-FBS
			2 pole, Cable connector, Metal shell, Blue sleeve, PG Gland	Screw	Nickel	SP-2-FNG
				Solder	Nickel	SP-2-FNSG
				Screw	Black	SP-2-FBG
				Solder	Black	SP-2-FBSG
			2 pole, Cable connector, Metal shell, Blue sleeve, PG Gland strain relief	Screw	Nickel	SP-2-FNL
				Solder	Nickel	SP-2-FNSL
				Screw	Black	SP-2-FBL
				Solder	Black	SP-2-FBSL

PRODUCT - FIGURE	DRAWING	DESCRIPTION	CONTACT TYPE	SHELL COLOUR	PART NUMBER
	 <p style="text-align: center;">Dimensions in mm (inches)</p>	4 pole, Cable connector, Thermoplastic black shell, Blue sleeve	Screw	Black	SP-4-F
			Solder	Black	SP-4-FS
		4 pole, Cable connector, Thermoplastic black shell, Blue sleeve, PG Gland	Screw	Black	SP-4-FG
			Solder	Black	SP-4-FSG
		4 pole, Cable connector, Thermoplastic black shell, Blue sleeve, PG Gland strain relief	Screw	Black	SP-4-FL
			Solder	Black	SP-4-FSL
		4 pole, Cable connector, Metal shell, Blue sleeve	Screw	Nickel	SP-4-FN
			Solder	Nickel	SP-4-FNS
			Screw	Black	SP-4-FB
			Solder	Black	SP-4-FBS
		4 pole, Cable connector, Metal shell, Blue sleeve, PG Gland	Screw	Nickel	SP-4-FNG
			Solder	Nickel	SP-4-FNSG
			Screw	Black	SP-4-FBG
			Solder	Black	SP-4-FBSG
		4 pole, Cable connector, Metal shell, Blue sleeve, PG Gland strain relief	Screw	Nickel	SP-4-FNL
			Solder	Nickel	SP-4-FNSL
			Screw	Black	SP-4-FBL
			Solder	Black	SP-4-FBSL

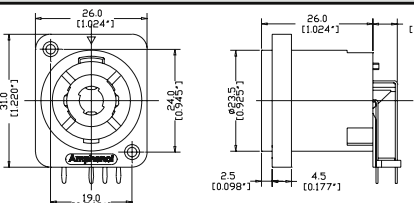

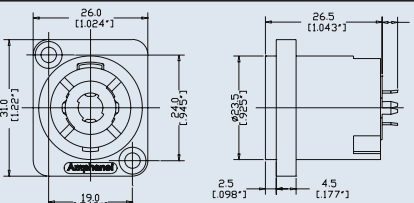
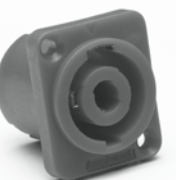
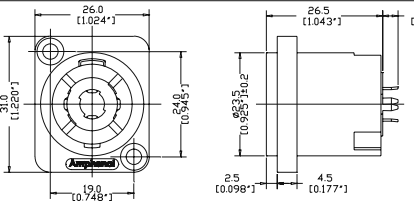
PRODUCT - FIGURE	DRAWING	Dimensions in mm (inches)	DESCRIPTION	VARIATIONS	PART NUMBER
			2 pole, D flange, Thru holes, Solder tabs 3/16"	Black	SP-2-MD
			2 pole, D flange, Thru holes, Horizontal PCB	Black	SP-2-MDH
			2 pole, D flange, Thru holes, Vertical PCB	Black	SP-2-MDV
			4 pole, D flange, Thru holes, Solder tabs 3/16"	Black	SP-4-MD
			4 pole, D flange, Thru holes, Solder tabs 3/16"	Grey	SP-4-MD-8
			4 pole, D flange, Self Tapping holes, Solder tabs 3/16"	Black	SP-4-MDT
			4 pole, D flange, Thru holes, Horizontal PCB	Black	SP-4-MDH
			4 pole, D flange, Self Tapping holes, Horizontal PCB	Grey	SP-4-MDHT-8

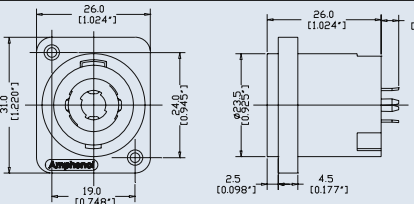

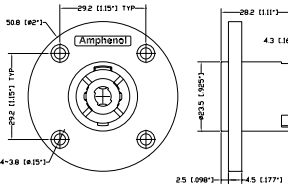
PRODUCT - FIGURE		DESCRIPTION	VARIATIONS	PART NUMBER
		4 pole, D flange, Self Tapping holes, Horizontal PCB	Black	SP-4-MDHT
		4 pole, D flange, Thru holes, Vertical PCB	Black	SP-4-MDV
		4 pole, D flange, Thru holes, Vertical PCB	Red	SP-4-MDV-2
		4 pole, D flange, Self Tapping holes, Vertical PCB	Grey	SP-4-MDVT-8
		4 pole, EP flange, Thru holes, Solder tabs 3/16"	Black	SP-4-MC



PART NUMBER BREAKDOWN

SP SERIES - CABLE CONNECTORS

E. G . **SP-4-FNSG**
SP (Series Prefix), **4** contacts, **F** (Cable Connector), **N** (Metal Shell Nickel Finish),
S (Solder Terminals), **G** (PG Gland)

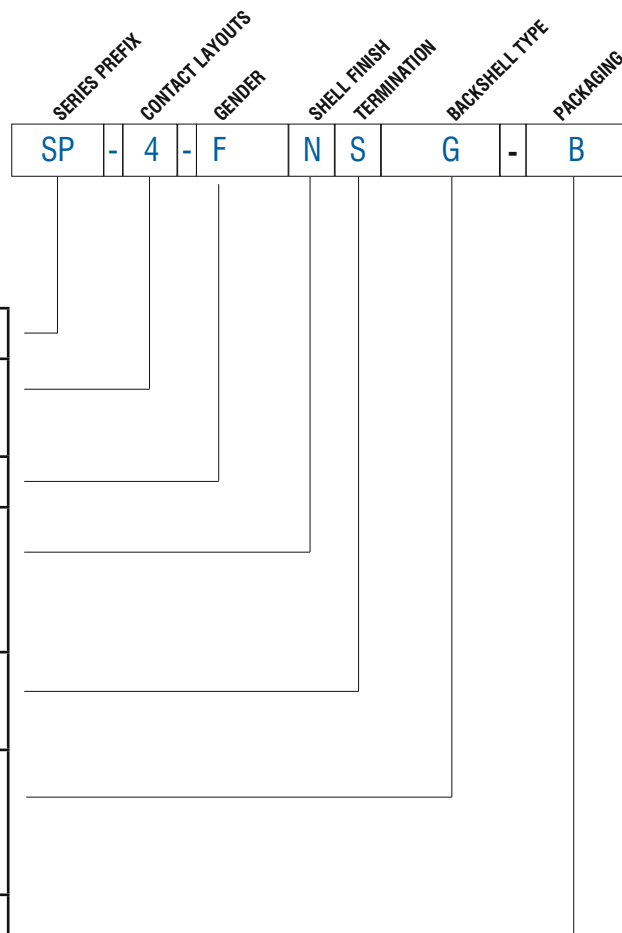

SERIES PREFIX	SP = Series Prefix
CONTACT LAYOUT	2 = 2 Contacts 4 = 4 Contacts
GENDER	F = Cable Connector
SHELL FINISH	Blank = Thermoplastic - Black N = Metal - Nickel Finish B = Metal - Black Finish
TERMINATION	Blank = Screw Terminals S = Solder Terminals
BACKSHELL TYPE	Blank = Standard G = PG Gland L = PG Gland Strain Relief
PACKAGING BACK-SHELL COLOUR	1 = Brown 2 = Red 3 = Orange 4 = Yellow 5 = Green 6 = Blue 7 = Violet 8 = Grey 9 = White
PACKAGING	Blank = Individual Bags B = Bulk Packed



PART NUMBER BREAKDOWN

SP SERIES - CHASSIS CONNECTORS

E. G. **SP-4-MDHT-8B**
SP (Series Prefix), **4** contacts, **M**(Chassis Connector), **D** (D Shell), **H**orizontal Printed Circuit Board, Self **T**apping mounting holes - **8** (Grey), **B**ulk Packaged.

SERIES PREFIX	SP	=	Series Prefix
CONTACT LAYOUT	2	=	2 Contacts
	4	=	4 Contacts
GENDER	M	=	Chassis Connector
SHELL STYLE	D	=	Standard 'D' Type flange
	C	=	EP Series Circular flange
TERMINATION	Blank	=	Solder tabs - 3/16" terminals
	V	=	Vertical Printed Circuit Board
	H	=	Horizontal Printed Circuit Board
MOUNTING HOLE	Blank	=	Thru Hole
	T	=	Self Tapping
SHELL COLOUR	Blank	=	Black
	2	=	Red
	8	=	Grey
PACKAGING	Blank	=	Individual Bags
	B	=	Bulk Packed

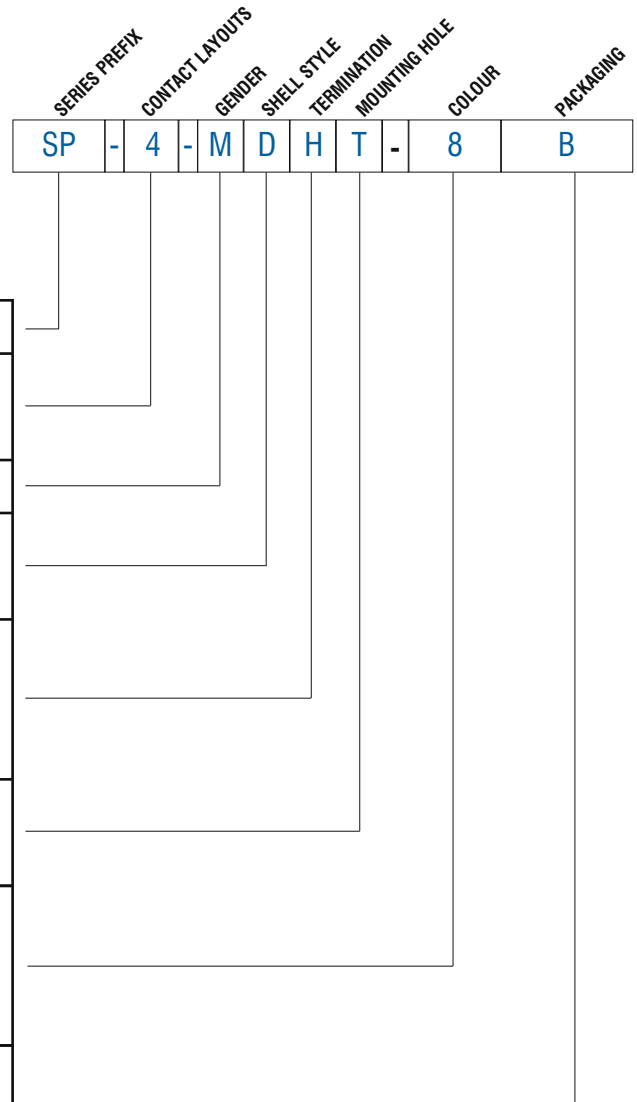

SP SERIES

SP-2-MDH

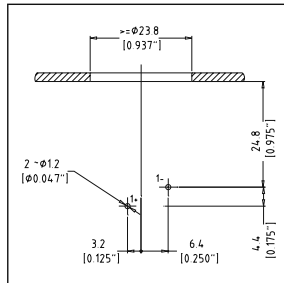

SP-2-MDV

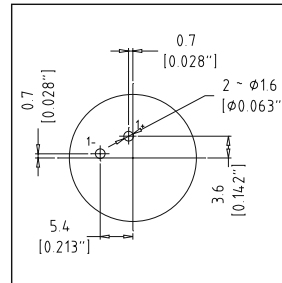

SP-4-MDH
SP-4-MDHT-8
SP-4-MDHT

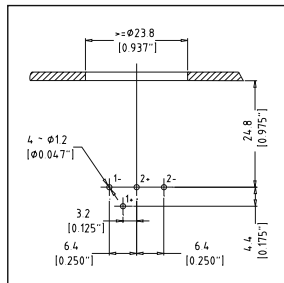

SP-4-MDV
SP-4-MDV-2
SP-4-MDVT-8

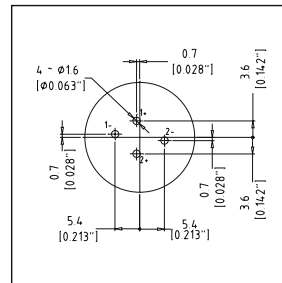

SP SERIES PANEL CUTOUT

SP-2-MD** *
SP-4-MD** *
_

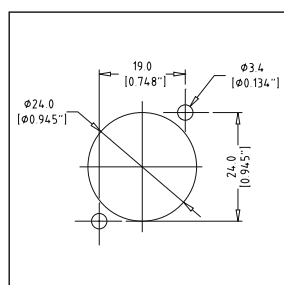

SP-4-MC

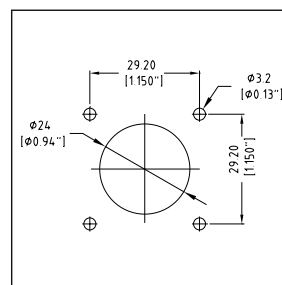

STANDARD DATA SP SERIES CONNECTORS

		VALUE	
GENERAL CHARACTERISTICS	Number of contacts	2 or 4	
	Termination (Chassis)	Printed Circuit Board (PCB) or Solder Tabs 3/16"	
	Termination (Cable Plugs)	Screw or Solder Terminals	
	Flammability	UL94HB	
	Environmental	Complies with EU RoHS 2 Directive 2011/65/EU	
ELECTRICAL CHARACTERISTICS	Service Voltage RMS	133V ¹⁾	
	Test Voltage AC RMS	1500V	
	Current carrying capacity	30A	
	Typical Contact Resistance	≤3mΩ	
	Insulation Resistance (initial)	≥2GΩ	
	Insulation Resistance (after damp heat test)	≥1GΩ	
CLIMATIC CHARACTERISTICS	Protection Class	IP54	
	Operating Temperature	-25 °C to +75 °C (-13°F to +167°F)	
MECHANICAL CHARACTERISTICS	Weight** - Chassis Connectors	12g (0.026lb)	
	Weight** - Cable Plug - Thermoplastic - Metal	44g (0.097lb)	
		65g (0.143lb)	
	Weight** - Cable Plug PG - Thermoplastic - Metal	44g (0.097lb)	
		65g (0.143lb)	
	Weight** - Cable Plug PG S/Relief - Thermoplastic - Metal	68g (0.150lb)	
		89g (0.196lb)	
	Typical Cable retention force	200N (Subject to cable material and O.D.)	
	Cable O.D range - Chuck Clamp - PG16 Gland - PG16 Gland S/Relief	2 pole 5-10mm (0.19" - 0.39")	4 pole 9-14mm (0.35" - 0.55")
		6-12mm (0.23" - 0.47")	8-14mm (0.31" - 0.55")
9-14mm (0.35" - 0.55")		9-14mm (0.35" - 0.55")	
Mechanical Operations	5000		
Fastening (Chassis Self Tapping)	M3 screw		
MATERIALS	Connector Shell / Finish - Chassis - Cable Plug Thermoplastic - Cable Plug Metal	PA66 GF20 / Black PA66 GF30 / Black Diecast Zinc Alloy / Nickel or Black	
	Insulators - Chassis - Cable Plugs	PA66 GF20 PA66 GF30	
	Cable Boot / Backshell	Santoprene / PA6 GF 15	
	Cable Clamp (Chuck)	P.O.M	
	Cable Clamp (PG)	Polyamide / EPDM	
	Sleeve	PBT	
	Contact Chassis - Material / Plating Contact Cable Plug - Material / Plating	Phosphor Bronze / Silver Brass / Silver	

¹⁾Not suitable for domestic applications above 50V







The EP Series has set the standard in high performance speaker connectors. Apart from its durability and strength, it offers consistent superior power handling capabilities.

Features:

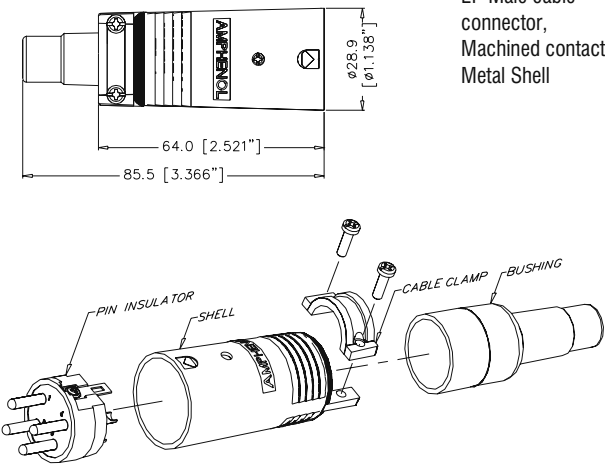

- Solder Bucket connections.
- Precision machined contacts.
- Diecast Metal Housings
- High current contacts
- Male and female cable and chassis connectors available.

Options: Black Finish Shell
Panel Cutouts: page 80

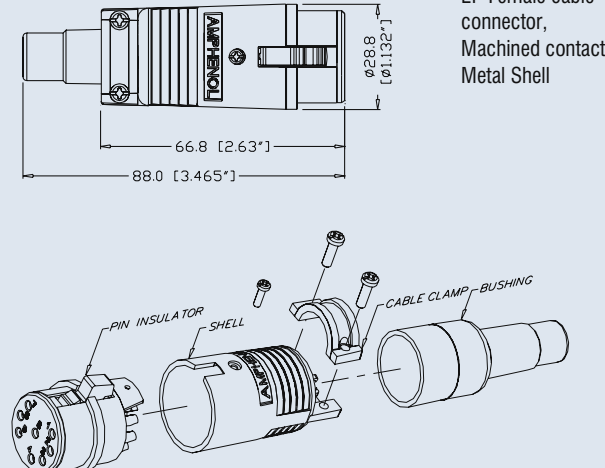
Specifications: page 79

PRODUCT - FIGURE	DRAWING	DESCRIPTION	VARIATIONS	PART NUMBER
 <p>ISO ASSEMBLY OF EP MALE</p>	<p>Dimensions in mm (inches)</p> 	<p>EP Male cable connector, Machined contacts, Metal Shell</p>	3 pole nickel finish	EP-3-12
			3 pole black finish	EP-3-12B
			4 pole nickel finish	EP-4-12
			4 pole black finish	EP-4-12B
			5 pole nickel finish	EP-5-12
			5 pole black finish	EP-5-12B
			6 pole nickel finish	EP-6-12
			6 pole black finish	EP-6-12B
			8 pole nickel finish	EP-8-12
8 pole black finish	EP-8-12B			
 <p>ISO ASSEMBLY OF EP FEMALE</p>		<p>EP Female cable connector, Machined contacts, Metal Shell</p>	3 pole nickel finish	EP-3-11P
			3 pole black finish	EP-3-11PB
			4 pole nickel finish	EP-4-11P
			4 pole black finish	EP-4-11PB
			5 pole nickel finish	EP-5-11P
			5 pole black finish	EP-5-11PB
			6 pole nickel finish	EP-6-11P
			6 pole black finish	EP-6-11PB
			8 pole nickel finish	EP-8-11P
8 pole black finish	EP-8-11PB			

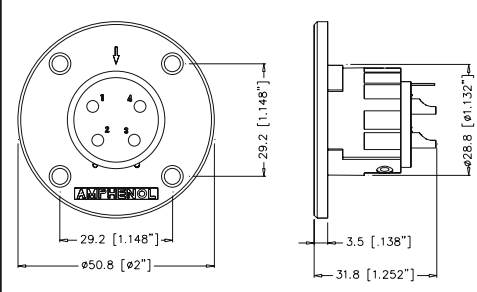

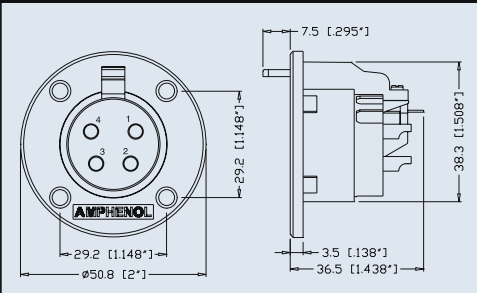
PRODUCT - FIGURE	DRAWING	DESCRIPTION	VARIATIONS	PART NUMBER
	<p style="text-align: center;">Dimensions in mm (inches)</p> 	<p>EP Male chassis mount, Round Flange, Machined contacts, Metal Shell</p>	3 pole nickel finish	EP-3-14
			3 pole black finish	EP-3-14B
			4 pole nickel finish	EP-4-14
			4 pole black finish	EP-4-14B
			5 pole nickel finish	EP-5-14
			5 pole black finish	EP-5-14B
			6 pole nickel finish	EP-6-14
			6 pole black finish	EP-6-14B
			8 pole nickel finish	EP-8-14
			8 pole black finish	EP-8-14B
		<p>EP Female chassis mount, Round Flange, Machined contacts, Metal Shell</p>	3 pole nickel finish	EP-3-13P
			3 pole black finish	EP-3-13PB
			4 pole nickel finish	EP-4-13P
			4 pole black finish	EP-4-13PB
			5 pole nickel finish	EP-5-13P
			5 pole black finish	EP-5-13PB
			6 pole nickel finish	EP-6-13P
			6 pole black finish	EP-6-13PB
			8 pole nickel finish	EP-8-13P
			8 pole black finish	EP-8-13PB





The AP Series provides the same power handling performance as the EP Series in a cost effective, yet durable Thermoplastic housing.

Features:

- Solder Bucket connections.
- Precision machined contacts.
- Thermoplastic Housings
- High current contacts
- Male & Female Cable and Chassis connectors available.

Specifications: page 79

Panel Cutouts: page 80

PRODUCT - FIGURE	DRAWING	Dimensions in mm (inches)	DESCRIPTION	VARIATIONS	PART NUMBER
		28.8 [1.135"] 100.0 [3.937"]	AP Male cable connector, Machined contacts, Thermoplastic Black shell.	4 pole 5 pole 6 pole 8 pole	AP-4-12 AP-5-12 AP-6-12 AP-8-12
		28.8 [1.132"] 98.7 [3.886"]	AP Female cable connector, Machined contacts, Thermoplastic Black shell.	4 pole 5 pole 6 pole 8 pole	AP-4-11 AP-5-11 AP-6-11 AP-8-11
		29.2 [1.15"] 29.2 [1.15"] 432.4 [16.276"] 30.6 [1.204"] 2.8 [0.11"] 6.2 [0.244"] 31.8 [1.252"]	AP Male chassis mount, Round Flange, Machined contacts, Thermoplastic Black shell.	4 pole 5 pole 6 pole 8 pole	AP-4-14 AP-5-14 AP-6-14 AP-8-14
		29.2 [1.148"] 29.2 [1.148"] 432.4 [16.276"] 38.3 [1.508"] 2.8 [0.11"] 6.2 [0.244"] 36.5 [1.438"]	AP Female chassis mount, Round Flange, Machined contacts, Thermoplastic Black shell.	4 pole 5 pole 6 pole 8 pole	AP-4-13 AP-5-13 AP-6-13 AP-8-13
		29.2 [1.148"] 29.2 [1.148"] 50.0 [1.969"] 432.4 [16.276"] 30.6 [1.204"] 2.8 [0.11"] 6.2 [0.244"] 31.8 [1.252"]	AP Male chassis mount, Rectangular Flange, Machined contacts, Thermoplastic Black shell.	4 pole 5 pole 6 pole 8 pole	AP-4-22 AP-5-22 AP-6-22 AP-8-22
		29.2 [1.148"] 29.2 [1.148"] 50.0 [1.969"] 432.4 [16.276"] 38.3 [1.508"] 2.8 [0.11"] 6.2 [0.244"] 36.5 [1.438"]	AP Female chassis mount, Rectangular Flange, Machined contacts, Thermoplastic Black shell.	4 pole 5 pole 6 pole 8 pole	AP-4-21 AP-5-21 AP-6-21 AP-8-21

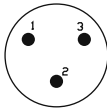
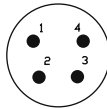
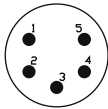
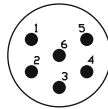
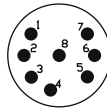

STANDARD DATA EP/AP

		VALUE				
GENERAL CHARACTERISTICS	Number of contacts	3	4	5	6	8
	Contact Arrangements (Front view of pin insert)					
	Termination	SOLDER				
	Wire Gauge - Stranded wire:	12AWG	12AWG	12AWG	12AWG	14AWG
	Flammability	UL94V-0				
Environmental	Complies with EU RoHS 2 Directive 2011/65/EU					
ELECTRICAL CHARACTERISTICS	Service Voltage RMS ¹⁾	460V	660V	200V	200V	100V
	Test Voltage AC RMS	2400V	3000V	1600V	1600V	1300V
	Current carrying capacity	20A	20A	20A	20A	15A
	Typical Contact Resistance	≤3mΩ				
	Insulation Resistance	≥1000MΩ				
CLIMATIC CHARACTERISTICS	Protection Class	IP40				
	Operating Temperature	-25 °C to +75 °C (-13°F to +167°F)				
MECHANICAL CHARACTERISTICS	Weight - EP 11 & 12 ²⁾	80g (0.176lb)	84g (0.185lb)	86g (0.189lb)	86g (0.189lb)	86g (0.189lb)
	Weight - EP 13 & 14 ²⁾	48g (0.105lb)	50g (0.110lb)	54g (0.119lb)	54g (0.119lb)	54g (0.119lb)
	Weight - AP 11 & 12 ²⁾	N/A	42g (0.092lb)	44g (0.097lb)	44g (0.097lb)	44g (0.097lb)
	Weight - AP 13, 14, 21 & 22 ²⁾	N/A	26g (0.057lb)	30g (0.066lb)	30g (0.066lb)	28g (0.061lb)
	Typical Cable retention force	22Kg to 44Kg (50lb to 100lb) - Dependant on cable material and diameter				
	Mechanical operations	1000 mating cycles				

¹⁾ Not suitable for domestic applications above 50V

²⁾ Approximate weight only, does not include packaging. Please contact us for exact weight for shipping purposes.



STANDARD DATA EP/AP (CONT'D)

		DETAILS	
MATERIALS	TYPE	AP	EP
	Connector shell	Modified PPE Resin	Diecast Zinc Alloy
	Shell finish	Black	Satin Nickel or Black
	Insulators	UL94V-0 PBT Resin	
	Cable Bushing	Silicon Rubber	UL94 HB Thermoplastic Elastomer
	Male contact Machined - Solder	Brass / Bright Tin	
	Material / Plating		
	Female contact Machined - Solder	Brass / Bright Tin	
	Material / Plating		
CLAMPING CHARACTERISTICS	Cable OD Range	11mm to 17mm (0.43" to 0.67")	9mm to 16mm (0.35" to 0.63")
	Retention Method	Two opposing plastic screws	Metal saddle clamp

Rev 3 - 03/2013

EP/AP SERIES PANEL CUTOUT DATA - FRONT VIEW

EP 13/AP 13/AP 21

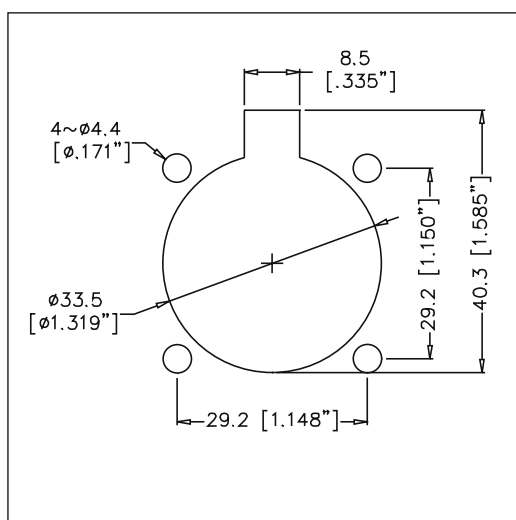

EP 14/AP 14/AP 22

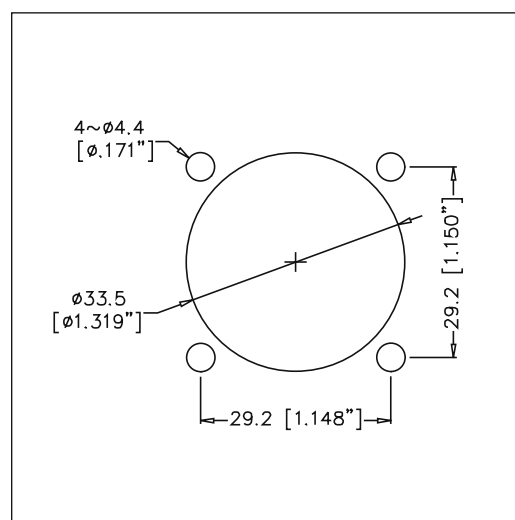

Amphenol

XLRnet CABLE CONNECTORS

METAL SHELL TYPE



XLRnet SERIES

Features/Benefits:

- XLR RJ45 Cable plug housing.
- Designed for pre-assembled RJ45 cables.
- Quick and simple installation.
- Cost effective method for harsh environments.
- No cabling in field required.
- No tools required for installation.
- Available in Nickel or Black housings.
- Coloured boots / Backshells

Specifications: page 82

Part Number Breakdown : page 82

Assembly Instructions: page 83

NOTE*RJ45 preassembled cable sold separately and is not included with the XLRnet connector.

PRODUCT - FIGURE	DRAWING	DESCRIPTION	VARIATIONS	PART NUMBER
	<p>Dimensions in mm (inches)</p>	XLRnet, XLR cable plug housing to suit preassembled RJ45 cables, Nickel Finish	<p>Standard</p> <p>Bulk Pack</p>	<p>RJX8M</p> <p>RJX8M BULK</p>
		XLRnet, XLR cable plug housing to suit preassembled RJ45 cables, Black Finish	<p>Standard</p> <p>Bulk Pack</p>	<p>RJX8MB</p> <p>RJX8MB BULK</p>

ISO VIEW OF RJX8M

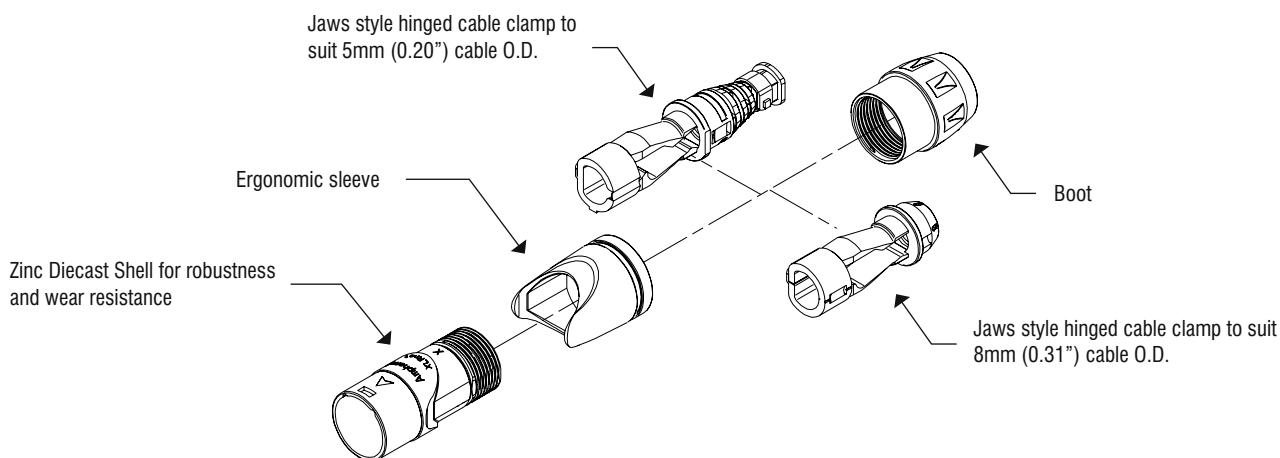

PART NUMBER BREAKDOWN

XLNet SERIES

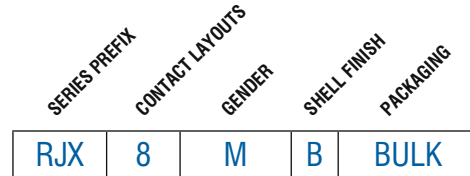

E. G. **RJX8MB BULK**
RJX (Series Prefix), **8** contacts, **M** (Cable Connector), **B** (Black Finish),
Bulk Packaged

SERIES PREFIX	RJX	=	Series Prefix
CONTACT LAYOUT	8	=	RJ45 Cable Housing
GENDER	M	=	Male Cable Plug
SHELL FINISH	Blank	=	Nickel Plated Finish
	B	=	Metal - Black Finish
PACKAGING	Blank	=	Individual Bags
	BULK	=	Bulk Packed

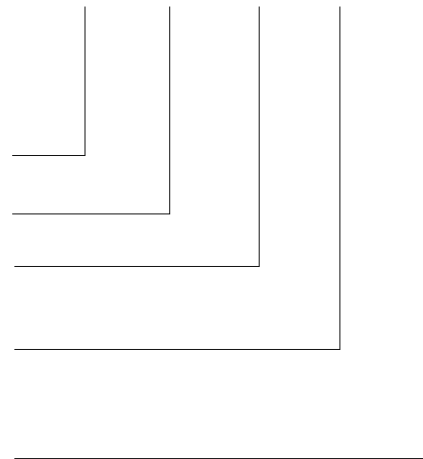

STANDARD DATA XLNet SERIES

		VALUE
GENERAL CHARACTERISTICS	Termination	Preassembled RJ45 Cable (Not supplied)
	Environmental	Complies with EU RoHS 2 Directive 2011/65/EU
CLIMATIC CHARACTERISTICS	Protection Class	IP40
	Operating Temperature	-25 °C to +75 °C (-13°F to -167°F)
MECHANICAL CHARACTERISTICS	Insertion and Withdrawal force	≥10N - ≤20N
	Weight ²⁾	26g (0.057lb)
	Cable O.D. range	5 or 8mm (0.20" or 0.31")
	Mechanical Operations	1000 mating cycles
MATERIALS	Connector shell - Metal Shell finish	Diecast Zinc Alloy Satin nickel or Black
	Boot / Backshell Finish	UL94V-0 Noryl N190 / Valox Black
	Cable clamp	PA6
	Sleeve	Valox

²⁾ Approximate weight only, does not include packaging. Please contact us for exact weight for shipping purposes.

XLrnet SERIES CABLE ASSEMBLY INSTRUCTIONS

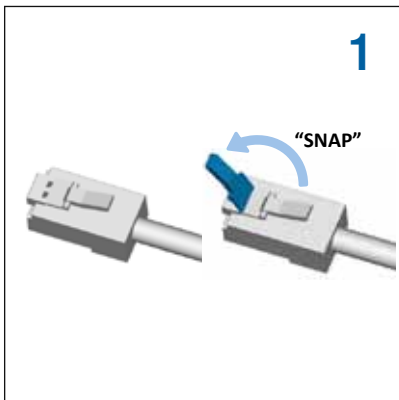

1 Snap or cut off release tab of the RJ45 plug.
 ⚠ Failure to remove the RJ45's Release Tab will make the XLrnet assembly permanently latching. The XLrnet series has an independent panel side latching system.

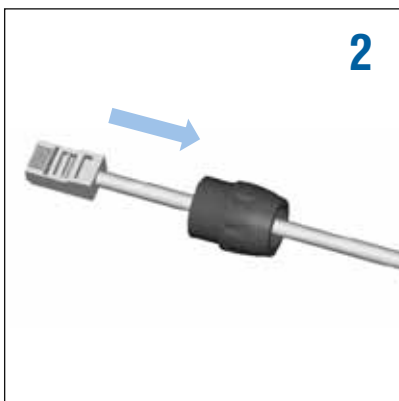

2 Slide the nut (backshell) onto the cable.

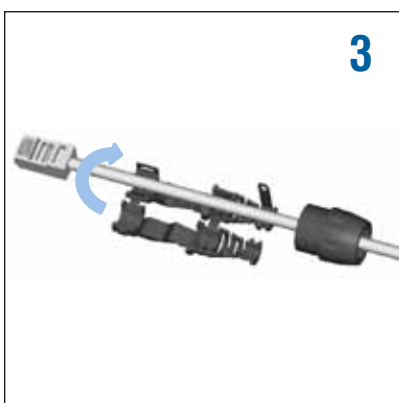

3 Install the cable clamp-boot.



4 Close clamp-boot, fasten the two tabs together to lock.

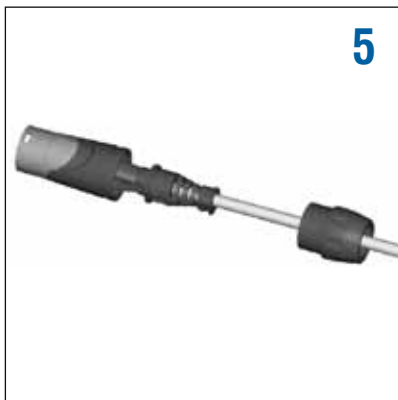

5 Push clamp-boot & cable together into the shell

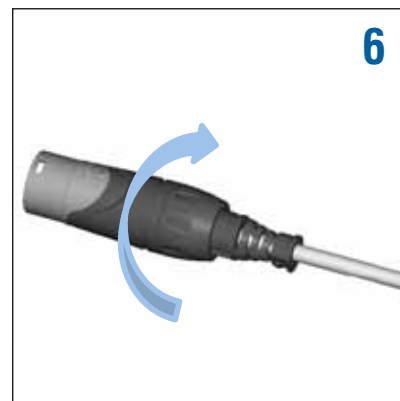

6 Thread the nut (backshell) onto the shell (torque 0.8nM-1.2nM) to close the connector assembly.





XLRnet CONNECTORS

XLRnet was designed in conjunction with the Amphenol Data / Telecom product group of Amphenol Canada Corp., a subsidiary of Amphenol Corporation. Utilising our combined expertise and knowledge of the professional audio and high-speed data markets we are proud to offer the XLRnet series. Featuring Class D or CAT 5E performance in A or B type housings with integrated LED's and complete shielding options we have your high-speed data requirements covered.

Features

- Class D or CAT 5E ethernet performance
- A or B type chassis housings
- Shielded or non-shielded
- LED indicators in a variety of colours.
- Compact design
- Cable plug housings
- Quick and simple installation

Options

- Horizontal PCB contacts
- Bulk Packaging
- LED colour - Red, Green, Yellow or Blue combinations

Ordering Codes

We have listed the more common ordering codes in each section. Please contact us if you need any further assistance.

Simple steps to guide you in using this catalogue

- 1) Identify the product group listed in Contents on page 1 and go directly to that page number.
- 2) Each product group cover page then details information and options available.
- 3) Refer to the product detail pages and identify the product you require pictorially.
- 4) Read the product description column for the products standard features.
- 5) Use variations column to determine your choice.
- 6) Identify part number.
- 7) In the event the particular option you require is not listed please refer to the part number breakdown page at the end of each section.
- 8) Please contact us directly if you have any further problems.



Features:

- RJ45 Class D or CAT 5e performance
- A or B type chassis housings
- Shielded or non-shielded
- LED indicators in a variety of colours.
- Horizontal PCB
- Mates with XLrnet cable plugs or standard RJ45 plug.

Part Number Breakdown: Page 86

Specifications: Page 88

PCB Footprints: Page 87

Recommended Fastener: Page 134

PRODUCT - FIGURE	DRAWING	Dimensions in mm (inches)	DESCRIPTION	PACK	LED* LHD/RHD		PART NUMBER
			XLrnet chassis, Class D, A type, Horizontal PCB	Bulk Pack	-	-	RJX8FA3HB
			XLrnet chassis CAT 5e, B type, Horizontal PCB	Bulk Pack	-	-	RJX8FB5HB
			XLrnet chassis, CAT 5e, B type, LEDs, Horizontal PCB, Bulk packed	Bulk Pack	R	G	RJX8FB5HRGB
					R	Y	RJX8FB5HRYB
					R	R	RJX8FB5HRRB
					G	R	RJX8FB5HGRB
					G	Y	RJX8FB5HGYB
			XLrnet chassis, CAT 5e, B type, Shielded Hood, Horizontal PCB, Bulk packed	Bulk Pack	-	-	RJX8FB5HEB
			XLrnet chassis, CAT 5e, B type, Shielded Hood, LEDs, Horizontal PCB, Bulk packed	Bulk Pack	R	G	RJX8FB5HRGEB
					R	Y	RJX8FB5HRYEB
					R	R	RJX8FB5HRRB
					G	R	RJX8FB5HGREB
					G	Y	RJX8FB5HGYEB
				U	U	RJX8FB5HUUEB	

*Note: LED colours are denoted left to right from the panel side front view. Refer page 87
R = Red, G = Green, Y = Yellow, U = Blue



PART NUMBER BREAKDOWN

XLRnet A AND B TYPE

E. G. **RJX8FB5HLRREB**
RJX (Series Prefix), **8** (Contacts), **F**emale **B** type, **H**orizontal, **L**atchless,
Red - Red LEDs, **E**MI / RFI Hood, **B**ulk Packaged.

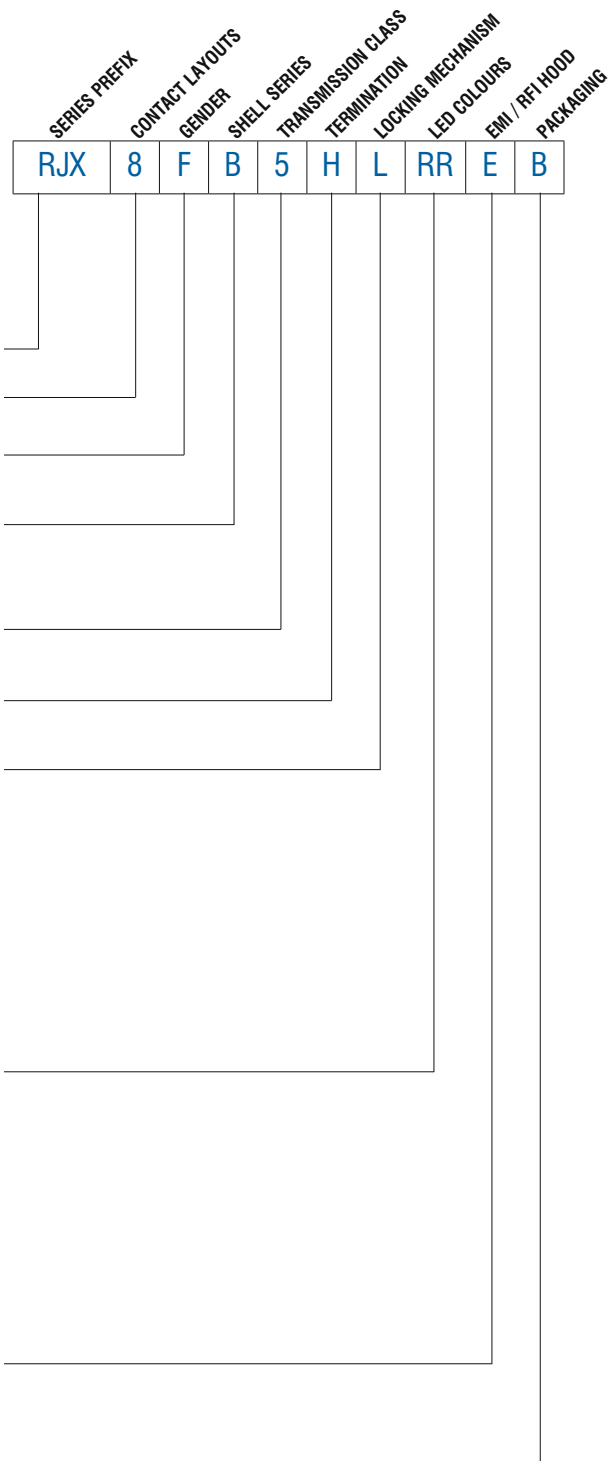

SERIES PREFIX	RJX	=	Series Prefix
CONTACT LAYOUT	8	=	RJ45 type
GENDER	F	=	Receptacle housing
SHELL SERIES	A	=	A Type
	B	=	B Type
TRANSMISSION CLASS	3	=	Class D
	5	=	CAT 5e
TERMINATION	H	=	Horizontal Printed Circuit Board
LOCKING MECHANISM	Blank	=	Latching
	L	=	Latchless
LED COLOUR SEQUENCE*	Blank	=	No LEDs
	RG	=	Red / Green
	RY	=	Red / Yellow
	RR	=	Red / Red
	GR	=	Green / Red
	GY	=	Green / Yellow
	GG	=	Green / Green
	YR	=	Yellow / Red
	YY	=	Yellow / Yellow
	YG	=	Yellow / Green
	UU	=	Blue / Blue
EMI / RFI SHIELDING HOOD	Blank	=	No shield hood
	E	=	EMI / RFI shield hood
PACKAGING	Blank	=	Individual
	B	=	Bulk packed

*Note: LED colours are denoted left to right from the panel side front view. Refer page 87



XLRNET A AND B TYPE SERIES

RJX8FA3H
RJX8FA3HB

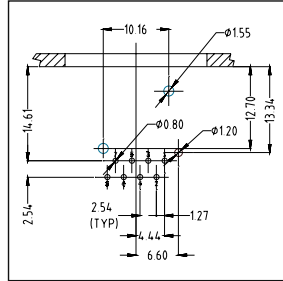

RJX8FB5H
RJX8FB5HB

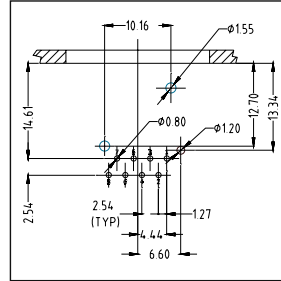

RJX8FB5HRGB
RJX8FB5HRYB
RJX8FB5HRRB
RJX8FB5HGRB
RJX8FB5HGYB
RJX8FB5HGGB

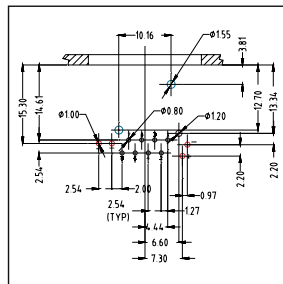

RJX8FB5HEB
RJX8FB5HEB
RJX8FB5HEB
RJX8FB5HEB
RJX8FB5HEB
RJX8FB5HEB

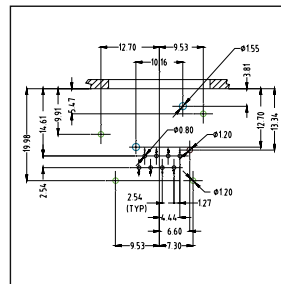

RJX8FB5HRGEB
RJX8FB5HRYEB
RJX8FB5HRREB
RJX8FB5HGREB
RJX8FB5HGYEB
RJX8FB5HGGB

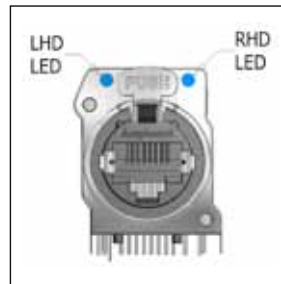
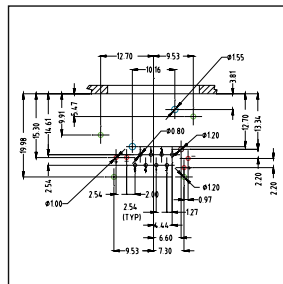

LED Arrangement
(Front view)

XLrnet
PANEL CUTOUT

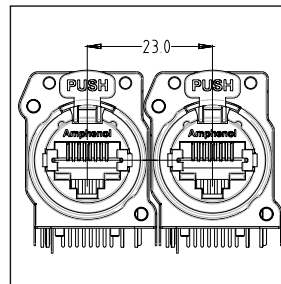
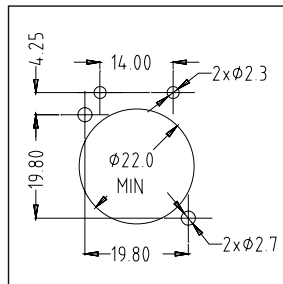

XLrnet MOUNTING
PITCH

XLrnet PoE +
PSE Pinout Alternatives

CONDUCTOR	Alternative-A (MDI-X)	Alternative-A (MDI)	Alternative-A (All)
1	Negative V_{PSE}	Positive V_{PSE}	
2	Negative V_{PSE}	Positive V_{PSE}	
3	Positive V_{PSE}	Negative V_{PSE}	
4			Positive V_{PSE}
5			Positive V_{PSE}
6	Positive V_{PSE}	Negative V_{PSE}	
7			Negative V_{PSE}
8			Negative V_{PSE}



STANDARD DATA XLrnet CHASSIS RECEPTACLES

		VALUE - Class D	VALUE - CAT 5e
GENERAL CHARACTERISTICS	Number of contacts	8	
	Contact Arrangement	RJ45	
	Termination	Printed Circuit Board (PCB) - through hole	
	Flammability	UL94V-0	
	Environmental	Complies with EU RoHS 2 Directive 2011/65/EU	
	Solderability	MIL-STD 202, Method 208	
ELECTRICAL CHARACTERISTICS	Rated current per contact	1.5 A	
	Rated Voltage	125V AC	
	Typical Contact Resistance	20mΩ	
	Insulation Resistance	> 500MΩ	
	Dielectric Strength	1000 VAC, 60 secs	
	Frequency Bandwidth	1 - 100Mhz	1 - 250Mhz
	Transmission Specification / Class	10/100 Base-T	1000 Base-T
	PoE+	802.3at Type 2	
	LED Type	Round, single pole, indicator	
CLIMATIC CHARACTERISTICS	Protection Class	IP40 (with EMI/RFI shield)	
	Operating Temperature	-40°C to +85°C	
MECHANICAL CHARACTERISTICS	Weight** - A & B Housing	11g (0.024lb)	
	- Shielded Housing	17g (0.037lb)	
	Mechanical Operations	1000	
	Insertion and Withdrawal Force	≤ 21N	
	Latch	Spring Steel	
	Panel Thickness	3mm	
	Mounting screw torque max.	1.5Nm	
	Fastener	Self-Tapping screw M2.5	
MATERIALS	Connector Shell / Housing	Thermoplastic, DSM Stanyl UL94V-0, 30% GF	
	Flange (A type)	Thermoplastic, DSM Stanyl UL94V-0, 30% GF	
	Flange (B type)	Diecast Zinc Alloy 3	
	Flange Finish (B type)	Satin Nickel	
	Contact	Phosphor Bronze	
	Contact Finish	0.38μm Au over 1.27μm Ni or 1.27μm Au over 1.27μm Ni	
	Metal Hood Shield EMI/RFI	Brass, nickel plated	
	Latch lock and Spring	Spring steel	

**Approximate weight in grams not including packaging. Please contact us for exact weight for shipping purposes.

Rev 1 - 03/2013



BNC 75 RF CONNECTORS

Amphenol offers a complete range of high-performance BNC plugs for use in digital/HD video applications. Amphenol's True 75 Ohm BNC connectors perform well up to and beyond 3GHz and are designed to terminate to a variety of popular coaxial cable types. We can also offer custom connectors to suit non-standard cables on request. Plugs feature a precision machined brass body and coupling nut plated with cost effective nickel plating.

Applications

- Broadcast
- High bandwidth video equipment
- D1/D2 serial digital
- Graphic work stations
- Telephony / Workstations

Options

- Crimp Plugs
- Jack to Jack adapters
- Patch Panels
- 'D' Shell Jacks
- Plug to Plug U-Link connectors
- Crimp Tools

Ordering Codes

We have listed the more common ordering codes in each section. Amphenol offer an extensive range of RF connectors for most applications.

Please visit www.amphenolconnex.com for further information. Please contact us if you need any further assistance.

Simple steps to guide you in using this catalogue



- 1) Identify the product group listed in Contents on page 1 and go directly to that page number.
- 2) Each product group cover page then details information and options available.
- 3) Refer to the product detail pages and identify the product you require pictorially.
- 4) Read the product description column for the products standard features.
- 5) Use variations column to determine your choice.
- 6) Identify part number.
- 7) In the event the particular option you require is not listed please refer to the part number breakdown page at the end of each section.
- 8) Please contact us directly if you have any further problems.







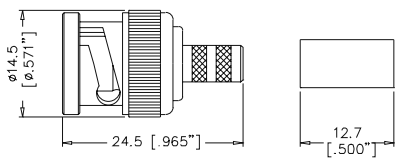
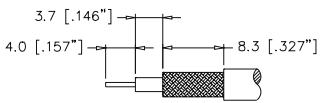

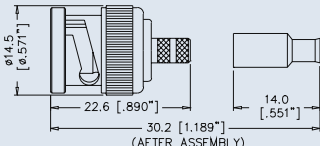
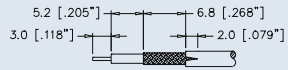



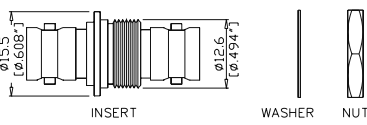

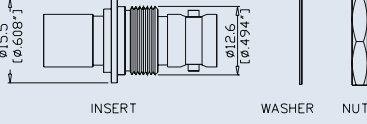

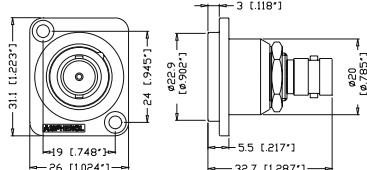

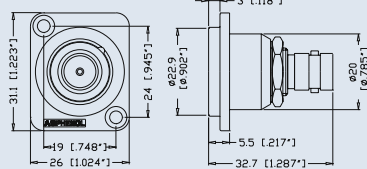
Amphenol manufactures a large range of connectors to suit cables other than those listed below, for example Belden YR23769 and 46899, please contact us to discuss your specific requirements.

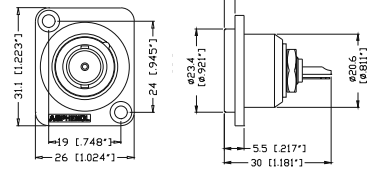
The complete Amphenol Connex catalogue featuring a wide range of RF connector products is available on request. Item code CAT-CONNEX-01.

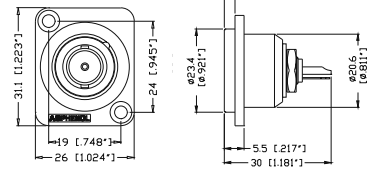
PRODUCT - FIGURE	DRAWING Dimensions in mm (inches)	CABLE TYPE RG-/U	INSULATION	CRIMP TOOL	PART NUMBER	
   <p>RECOMMENDED CABLE STRIPPING DIMS.</p>	<p>Straight Crimp Plug - Captive Contact- Standard Cable</p> <p>Assembly Instruction A - page 89</p>	59/ 62/ 140/ 210	Delrin	A	112119	
			Teflon	E	112952*	
			59/ U-20AWG	Delrin	A	112507
			Teflon	E	112956*	
			11/ U-14AWG/ B8213/ B9292/ B7731/ B1859A	Teflon	D	112606
			6/ 143/ 212	Delrin	E	112508
			B1694A/ B9248	Delrin	E	112565
			Teflon	E	112957*	
			6 PLENUM/ B1695A	Delrin	E	112519
			B8281/ B9231/ B9141	Delrin	E	112509
			Teflon	E	112953*	
			B1505A	Teflon	E	112951*
	B735A1	Teflon	F	112950*		
   <p>RECOMMENDED CABLE STRIPPING DIMS.</p>	<p>Straight Crimp Plug-Captive Contact-Miniature Cable (Remark: With Teflon sleeve / Hex crimp size .178")</p> <p>Assembly Instruction B - page 89</p>	179/ 187/ B9221	Delrin	B	112133	
			180/ 195/ 122/ B8218/ B1865A/ B1855	Delrin	B	112521
			Teflon	F	112955*	

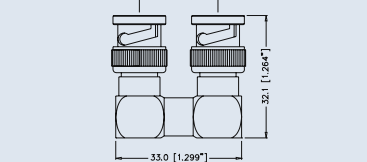
Note: *True 75 ohm.

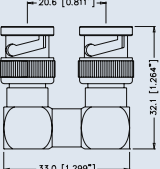
PRODUCT - FIGURE	DRAWING Dimensions in mm (inches)	DESCRIPTION & CABLE TYPE RG-/U	INSULATION	CRIMP TOOL	PART NUMBER
		Bulkhead Adapter -Isolated Jack to Jack - Straight Bayonet Lock to Bayonet Lock	Teflon	N/A	AC-BNC-JJA-75T*
		Bulkhead Adapter -Isolated Jack to Jack - Straight Push on to Bayonet Lock	Teflon	N/A	AC-BNC-PJA-75T*
		Bulkhead Adapter -Isolated, 'D' Shell Housing Jack to Jack, Bayonet Lock to Bayonet Lock, Nickel Finish	Teflon	N/A	AC-BNC-JJ-75*
		Bulkhead Adapter -Isolated, 'D' Shell Housing Jack to Jack, Push on to Bayonet Lock, Nickel Finish	Teflon	N/A	AC-BNC-PJ-75*
		Bulkhead Adapter -Isolated, 'D' Shell Housing Jack to Jack, Push on to Bayonet Lock, Black Finish	Teflon	N/A	AC-BNC-PJ-75B*
		Bulkhead Receptacle -Isolated, 'D' Shell Housing Jack to Solder Bucket with Ground Tag, Nickel Finish	Nylon	N/A	AC-BNC-JS-75
		Bulkhead Receptacle -Isolated, 'D' Shell Housing Jack to Solder Bucket with Ground Tag, Black Finish	Nylon	N/A	AC-BNC-JS-75B
		U - Link Centre to Centre - 20.6 mm Note: Custom Sizes available please contact factory.	Teflon	N/A	BNC-U-LINK 75*1

BNC 75 RF ACCESSORIES AND TOOLING

PRODUCT - FIGURE	DESCRIPTION	DIE CAVITIES	CABLE TYPE RG-/U	CONNECTOR GUIDE	PART NUMBER
	Crimp tool with Die Set	.255 / .213 / .068	59 / 62	A	47-10070
		.178 / .128 / .068	179 / 187 / 180 / 195	B	47-10150
		.429 / .100 / .080	11	D	47-10090
		.324 / .255 / .068 / .042	6 / 59 / B8281	E	47-10110
		.213 / .178 / .068 / .042	AT&T 735A, B1855A, B8218	F	47-10120

Note: *True 75 ohm.



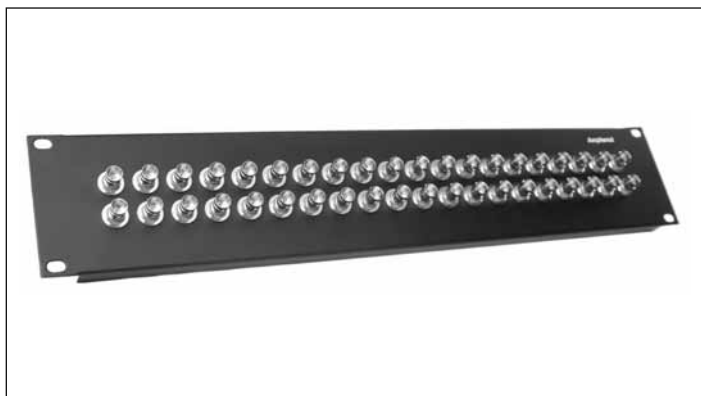

Features:

- Amphenol True 75 Ohm Connectors
- Bayonet lock or Push-on types
- Supplied with adhesive strip ID labels

Options:

- 1RU, 20 BNC connectors or 2RU, 40 BNC connectors
- Aluminium in Clear or Black anodised
- Steel in Black powder coat
- Customised versions available on request

PRODUCT - FIGURE DRAWING	Dimensions in mm (inches)	DESCRIPTION	MATERIAL / FINISH	LOADED WITH <small>(refer to page 84 for specifications)</small>	PART NUMBER
		1RU 1X20 Patch Panel, Supplied with 1 ID label	Steel / Black	Empty Panel	AC-BNC20M
		Steel / Black	AC-BNC-JJA-75	AC-BNC20MJ75	
		Steel / Black	AC-BNC-PJA-75	AC-BNC20MP75	
		Aluminium / Clear	Empty Panel	AC-BNC20A	
		Aluminium / Clear	AC-BNC-JJA-75	AC-BNC20AJ75	
		Aluminium / Clear	AC-BNC-PJA-75	AC-BNC20AP75	
		Aluminium / Black	Empty Panel	AC-BNC20B	
		Aluminium / Black	AC-BNC-JJA-75	AC-BNC20BJ75	
		Aluminium / Black	AC-BNC-PJA-75	AC-BNC20BP75	
		2RU 2X20 Patch Panel, Supplied with 2 ID labels	Steel / Black	Empty Panel	AC-BNC40M
		Steel / Black	AC-BNC-JJA-75	AC-BNC40MJ75	
		Steel / Black	AC-BNC-PJA-75	AC-BNC40MP75	
		Aluminium / Clear	Empty Panel	AC-BNC40A	
		Aluminium / Clear	AC-BNC-JJA-75	AC-BNC40AJ75	
		Aluminium / Clear	AC-BNC-PJA-75	AC-BNC40AP75	
		Aluminium / Black	Empty Panel	AC-BNC40B	
		Aluminium / Black	AC-BNC-JJA-75	AC-BNC40BJ75	
		Aluminium / Black	AC-BNC-PJA-75	AC-BNC40BP75	
Panel ID label		Plastic	Not Applicable	AC-BNC-LABEL	



BNC 75 RF ASSEMBLY INSTRUCTIONS

ASSEMBLY A

STEP 1

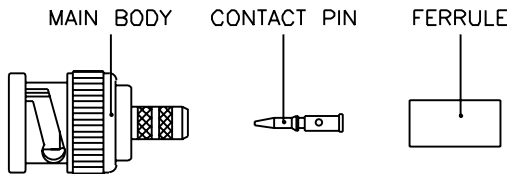

STEP 2

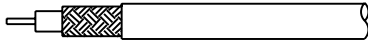

STEP 3

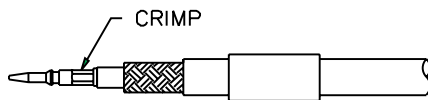

STEP 4

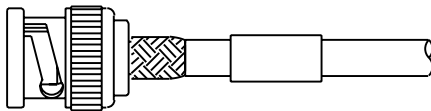

STEP 5

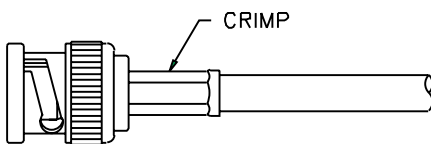

STEP 1. All parts of the connector are shown. A crimp tool is necessary to complete the connection.

STEP 2. Strip the cable inner conductor, dielectric, braid, and jacket as per "RECOMMENDED CABLE STRIPPING DIM'S" in catalogue.

STEP 3. Insert inner conductor into the CONTACT PIN, crimp it with the crimp tool as shown. Then slide the FERRULE onto cable.

STEP 4. Insert the MAIN BODY into braid and dielectric.

STEP 5. Slide the FERRULE over braid, crimp it with the crimp tool as shown.

ASSEMBLY B

STEP 1

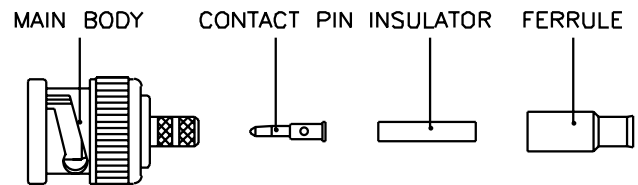

STEP 2

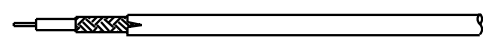

STEP 3

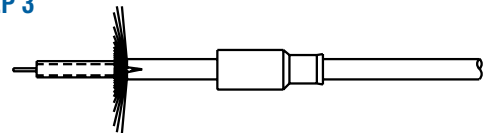

STEP 4

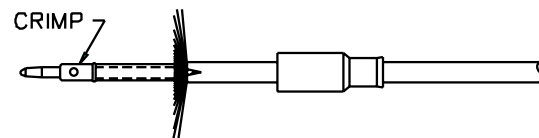

STEP 5

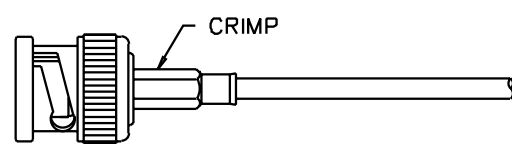

STEP 1. All parts of the connector are shown. A crimp tool is necessary to complete the connection.

STEP 2. Strip the inner conductor, dielectric, and jacket as per "RECOMMENDED CABLE STRIPPING DIM'S" in catalogue.

STEP 3. Slide the FERRULE on to cable, then fold back braid wire and slide the INSULATOR on to dielectric as shown.

STEP 4. Insert inner conductor into the CONTACT PIN, crimp it with crimp tool as shown.

STEP 5. Push cable and parts into the MAIN BODY until it stops. Then slide the FERRULE over braid wire and against the MAIN BODY, crimp it with the crimp tool as shown.



STANDARD DATA BNC 75 RF CONNECTORS

		VALUE	
GENERAL CHARACTERISTICS	Mating	Bayonet Lock	
	Cable Attachment	Crimp - Crimp	
	Environmental	Complies with EU RoHS 2 Directive 2011/65/EU	
ELECTRICAL CHARACTERISTICS	Impedance	75Ω	
	Frequency Range - Standard	0 - 1 GHz	
	- True 75 Ohm	0 - 4 GHz	
	Voltage Rating	500V RMS	
	Dielectric withstanding voltage	1500 Volts RMS	
	VSWR - Standard	1.05+0.1f(GHz) DC to 1 GHz	
	- True 75 Ohm	1.5+0.1f(GHz) DC to 4 GHz	
	Contact Resistance		
Centre Contact	1.5 milliohm		
Outer Contact	1.0 milliohm		
Insulation Resistance	5000 MΩ (min.)		
MATERIALS	Part	Material	Finish
	Body, Coupling sleeves	Brass	Nickel
	Crimp Ferrule	Annealed Copper	Nickel
	Male Contact	Brass	Gold
	Female Contact	Beryllium Copper or Phosphor Bronze	Gold
	XLR Housing	Diecast Zinc Alloy	Satin Nickel or Black Polyester
	Insulators	Teflon or Delrin	Natural

NOTE: These characteristics are typical and may not apply to all connectors.

PANEL CUTOUTS - FRONT VIEW

AC-BNC-PJ-75
AC-BNC-JJ-75

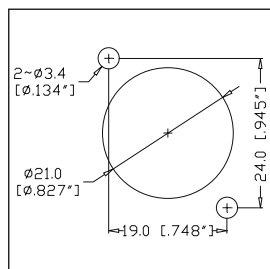

AC-BNC-PJA-75
AC-BNC-JJA-75

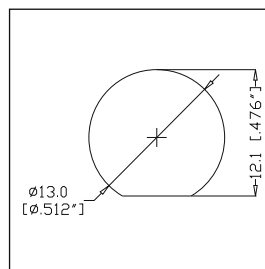

Rev 4 - 03/2013



1/4" PHONE CONNECTORS

Amphenol offers two ranges of 1/4" Phone plug connectors to satisfy the needs of the manufacturer and the end user. The PRO – a heavy duty on-road plug and the MUSICIAN - a solid performing general use plug. Both series offer different features and benefits and the most suitable type will be determined by application, budget and personal choice.

Applications

- Audio Cables and Snakes
- Amplifiers
- Speakers
- Mixing desks
- Rack mount equipment
- Patch panel

Features / Options – PRO RANGE 1/4" Phone Plug T-Series.

- Mono or Stereo (TRS)
- Switching Plugs
- Stylised shell design with Ergonomic grip
- Nickel or Gold contact plating
- Straight or Right Angle
- Keyed Shell
- Optional heavy duty metal backshell / boot
- Great solderability
- Increased solder area on ground contact
- "Jaws" Cable Clamp
- Precision machined contacts
- Coloured Grommet
- JUMBO Series Plugs

Features / Options – MUSICIAN RANGE 1/4" Phone Plug

- Mono or Stereo (TRS)
- Compact Shell
- Straight or Right angle
- Stylish shell design
- Flexible grommet cable protection
- Nickel or Gold contact plating
- Satin Nickel or Black finish
- Diecast shell
- Coloured Grommet

Jaws Cable Clamp Options for T-Series*



Standard Jaws cable clamp (Black), Cable O.D 3mm to 6mm (0.118" to 0.236")



Large Jaws cable clamp (Purple), Cable O.D 6mm to 7mm (0.236" to 0.275")

*Note: Applicable to T-Series straight cable connectors only. Refer to page 98 for right angle connector Jaws cable clamp specifications.

Musician Range Cable Clamp Options



M-Series, Cable O.D 3mm to 6.5mm (0.118" to 0.256")



M-Series II, Cable O.D 6.5mm to 8mm (0.256" to 0.315")

Ordering Codes

We have listed the more common ordering codes in each section. Refer to our 1/4" plug product feature matrix found on the next page for assistance on selecting the right plug for your application.

Simple steps to guide you in using this catalogue

- 1) Identify the product group listed in Contents on page 1 and go directly to that page number.
- 2) Each product group cover page then details information and options available.
- 3) Refer to the product detail pages and identify the product you require pictorially.
- 4) Read the product description column for the products standard features.
- 5) Use variations column to determine your choice.
- 6) Identify part number.
- 7) In the event the particular option you require is not listed please refer to the part number breakdown page at the end of each section.
- 8) Please contact us directly if you have any further problems.



1/4" PLUG FEATURE MATRIX

FEATURES		T SERIES (STRAIGHT)	T SERIES (RIGHT ANGLE)	JUMBO T SERIES	SWITCHPLUG T SERIES (STRAIGHT)	SWITCHPLUG T SERIES (RIGHT ANGLE)	M SERIES	M SERIES II	CUSTOM SERIES ¹
PRECISION MACHINED CONTACTS		X	X	X	X	X	X	X	X
CENTER CONTACT	1 pc. Center Contact	X	X	X	X	X			X*
	2 pc Press Fit Tip/Center Contact					X	X		X*
BARREL:	Machined Tube	X	X	X	X	X			
	Precision Extruded Tube					X	X		X
JAWS CABLE CLAMP		X	X		X	X			
MIN. CABLE OD	Black Jaw: 3mm/0.118"	X	X		X	X			
	Purple Jaw: 6mm/0.236"	X			X				
	Purple Jaw: 5.5mm/0.216"		X			X			
MAX. CABLE OD	Black Jaw: 6mm/0.236"	X			X				
	Black Jaw: 5.5mm/0.216"		X			X			
	Purple Jaw: 7.5mm/0.295"	X			X				
	Purple Jaw: 6.5mm/0.255"		X			X			
STANDARD CABLE CLAMP				X			X	X	X
MIN. CABLE OD	7.5mm/0.295"			X					
MAX. CABLE OD	6mm/0.236"					X			
	8mm/0.315"						X		
	8.8mm/0.345"							X	
	10.5mm/0.413"			X					
BACKSHELL FINISH	Satin Nickel	X	X	X	X	X	X	X	
	Black	X	X	X	X	X	X	X	
	Bright Nickel								X
	Bright Gold								X
CONTACT MATERIAL/ FINISH OPTIONS	Brass/Nickel (Ni)	X	X	X	X	X	X	X	X
	Brass/Gold over 2µm (Ni)	X	X	X	X	X	X	X	X

¹Custom Series - Minimum order quantities apply. Contact us for further details.



Features:

- Mono or Stereo (TRS).
- Stylised shell design with Ergonomic grip.
- Straight or Right Angle.
- Robust diecast shell in Satin nickel or Black finish.
- Nickel or Gold contact plating.
- Keyed shell.
- Optional heavy duty metal backshell / boot.
- Great solderability.
- Increased solder area on ground contact.
- "Jaws" Cable Clamp.
- Precision machined contacts.
- Quick and easy assembly.

Options: Gold Contacts, Large or Small Jaws Cable Clamp, Black Shell, Metal Backshell / Boot, Bulk Pack. Coloured grommets (ordered separately)

Part Number Breakdown: Page 97 Specifications: Page 98

PRODUCT - FIGURE	DRAWING	DESCRIPTION	VARIATIONS	PART NUMBER
		1/4" (6.35mm \varnothing) Mono Phone plug, Jaws cable clamp, Thermoplastic back-shell, Satin finish.	Standard	TM2P
			Gold Plated Contacts	TM2P-AU
			Large Cable Clamp	TM2PJ
			Bulk Pack	TM2P BULK
		1/4" (6.35mm \varnothing) Mono Phone plug, Jaws cable clamp, Thermoplastic back-shell, Black finish.	Standard	TM2PB
			Gold Plated Contacts	TM2PB-AU
			Large Cable Clamp	TM2PBJ
			Bulk Pack	TM2PB BULK
		1/4" (6.35mm \varnothing) Stereo Phone plug, Jaws cable clamp, Thermoplastic back-shell, Satin finish.	Standard	TS3P
			Gold Plated Contacts	TS3P-AU
			Large Cable Clamp	TS3PJ
			Bulk Pack	TS3P BULK
		1/4" (6.35mm \varnothing) Stereo Phone plug, Jaws cable clamp, Thermoplastic back-shell, Black finish.	Standard	TS3PB
			Gold Plated Contacts	TS3PB-AU
			Large Cable Clamp	TS3PBJ
			Bulk Pack	TS3PB BULK



Amphenol

PRODUCT - FIGURE	DRAWING	DESCRIPTION	VARIATIONS	PART NUMBER
		1/4" (6.35mm \varnothing) Mono Phone plug, Jaws cable clamp, Metal backshell, Satin finish.	Standard Gold Plated Contacts Large Cable Clamp Bulk Pack	TM2PN TM2PN-AU TM2PNJ TM2PN BULK
		1/4" (6.35mm \varnothing) Mono Phone plug, Jaws cable clamp, Metal backshell, Black finish.	Standard Gold Plated Contacts Large Cable Clamp Bulk Pack	TM2PBM TM2PBM-AU TM2PBMJ TM2PBM BULK
		1/4" (6.35mm \varnothing) Stereo Phone plug, Jaws cable clamp, Metal backshell, Satin finish.	Standard Gold Plated Contacts Large Cable Clamp Bulk Pack	TS3PN TS3PN-AU TS3PNJ TS3PN BULK
		1/4" (6.35mm \varnothing) Stereo Phone plug, Jaws cable clamp, Metal backshell, Black finish.	Standard Gold Plated Contacts Large Cable Clamp Bulk Pack	TS3PBM TS3PBM-AU TS3PBMJ TS3PBM BULK
		1/4" (6.35mm \varnothing) Mono Phone plug, Right angle, Jaws cable clamp*, Thermoplastic backshell, Satin finish.	Standard Gold Plated Contacts Small Cable Clamp Bulk Pack	TM2RJ TM2RJ-AU TM2R TM2RJ BULK
		1/4" (6.35mm \varnothing) Mono Phone plug, Right angle, Jaws cable clamp*, Thermoplastic backshell, Black finish.	Standard Gold Plated Contacts Small Cable Clamp Bulk Pack	TM2RBJ TM2RBJ-AU TM2RB TM2RBJ BULK
		1/4" (6.35mm \varnothing) Stereo Phone plug, Right angle, Jaws cable clamp*, Thermoplastic backshell, Satin finish.	Standard Gold Plated Contacts Small Cable Clamp Bulk Pack	TS3RJ TS3RJ-AU TS3R TS3RJ BULK
		1/4" (6.35mm \varnothing) Stereo Phone plug, Right angle, Jaws cable clamp*, Thermoplastic backshell, Black finish.	Standard Gold Plated Contacts Small Cable Clamp Bulk Pack	TS3RBJ TS3RBJ-AU TS3RB TS3RBJ BULK

*NOTE: Refer to page 98 for Jaws cable clamp specifications applicable to right angle connectors.



Amphenol

SwitchPlug



1/4" PHONE PLUGS

T-SERIES SWITCHPLUG



The Amphenol T series SwitchPlug uses a unique 360 degree precision sliding helical spring contact design to quietly and accurately switch the signal circuit safely to ground during instrument changes under load, thereby avoiding annoying thumps, pops and squeals. The sliding ring contact self-cleans every time the plug is connected preventing excessive build up of oxidization and contamination. Activation is directly off the jacks full front face assuring a positive reference point every time, and as it works instantaneously on the main circuits there is no need for the use of magnets or other elaborate switching mechanisms.

WARNING!
For use with
instrument (guitar)
applications only.

Part Number Breakdown: page 102
Specifications: page 103

US Patent No.8,162,697

PRODUCT - FIGURE	DRAWING	DESCRIPTION	VARIATIONS	PART NUMBER
		1/4" (6.35mmø) Switch Phone plug, Jaws cable clamp, Thermoplastic back- shell, Satin finish.	Standard Gold Plated Contacts Large Cable Clamp Bulk Pack	TM1P TM1P-AU TM1PJ TM1P BULK
		1/4" (6.35mmø) Switch Phone plug, Jaws cable clamp, Thermoplastic back- shell, Black finish.	Standard Gold Plated Contacts Large Cable Clamp Bulk Pack	TM1PB TM1PB-AU TM1PBJ TM1PB BULK
		1/4" (6.35mmø) Switch Phone plug, Right angle, Jaws cable clamp*, Thermoplastic back- shell, Satin Finish.	Standard Gold Plated Contacts Bulk Pack	TM1RJ* TM1RJ-AU* TM1RJ BULK*
		1/4" (6.35mmø) Switch Phone plug, Right angle, Jaws cable clamp*, Thermoplastic back- shell, Black Finish.	Standard Gold Plated Contacts Bulk Pack	TM1RBJ* TM1RBJ-AU* TM1RBJ BULK*

*NOTE: Refer to page 98 for Jaws cable clamp specifications applicable to right angle connectors.



SwitchPlug - User Instruction

CAUTION! Use with instrument (guitar) cables only. DO NOT connect to amplifier output. Equipment damage may result from incorrect use.

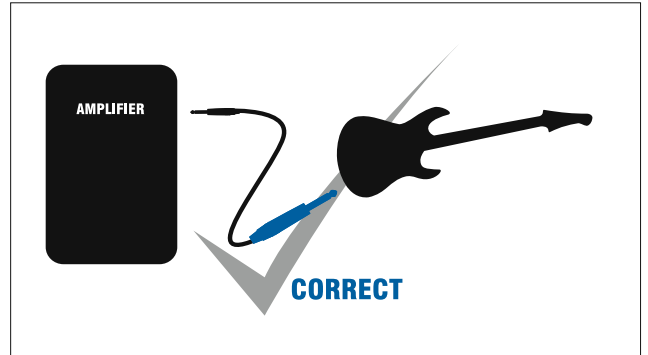
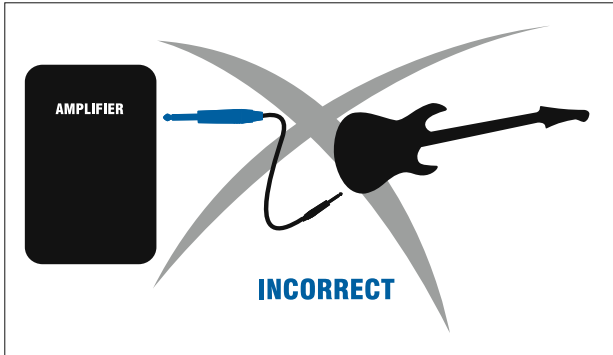

SwitchPlug - Technology*

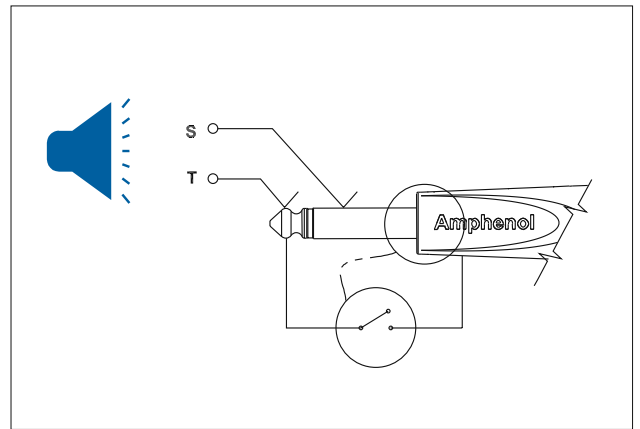
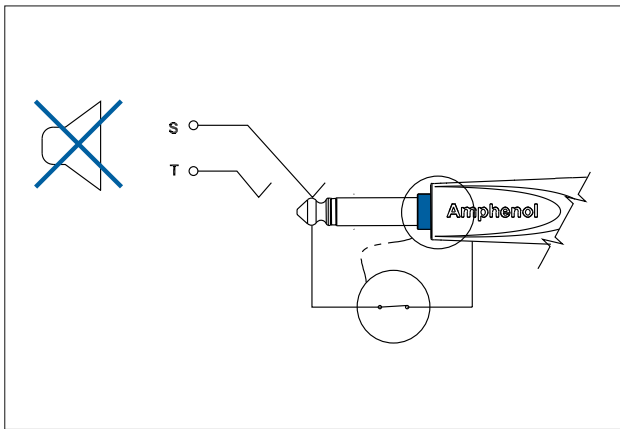

*US Patent No. 8,162,697



Features:

- JUMBO Cable clamping capacity
- Suits Cable OD 7.5mm (0.295") to 10.5mm (0.413")
- Mono or Stereo (TRS).
- Stylised shell design with Ergonomic grip.
- Robust diecast shell in Satin nickel or Black finish.
- Nickel or Gold contact plating.
- Keyed shell.
- Great solderability.
- Increased solder area on ground contact.
- Precision machined contacts.
- Quick and easy assembly.

Options: Gold Contacts, Bulk Pack.

Specifications: page 103

PRODUCT - FIGURE	DRAWING	DESCRIPTION	VARIATIONS	PART NUMBER
		1/4" (6.35mm \varnothing) JUMBO Mono Phone plug, Thermoplastic back- shell, Satin finish.	Standard Gold Plated Contacts Bulk Pack	JM2P JM2P-AU JM2P BULK
		1/4" (6.35mm \varnothing) JUMBO Mono Phone plug, Thermoplastic back- shell, Black finish.	Standard Gold Plated Contacts Bulk Pack	JM2PB JM2PB-AU JM2PB BULK
		1/4" (6.35mm \varnothing) JUMBO Stereo Phone plug, Thermoplastic back- shell, Satin finish.	Standard Gold Plated Contacts Bulk Pack	JS3P JS3P-AU JS3P BULK
		1/4" (6.35mm \varnothing) JUMBO Stereo Phone plug, Thermoplastic back- shell, Black finish.	Standard Gold Plated Contacts Bulk Pack	JS3PB JS3PB-AU JS3P BULK

NOTE: Contact factory for availability of metal backshells.



PART NUMBER BREAKDOWN

T-SERIES (PRO RANGE)

E. G. **TS3PBMJ-AU BULK**
T (Series Prefix), **S3** (Stereo), **P** (Plug Black), **M** (Metal Nut (Black)), **J** (Large Jaws),
- AU (Gold Plated Contacts), **BULK** Packaged.

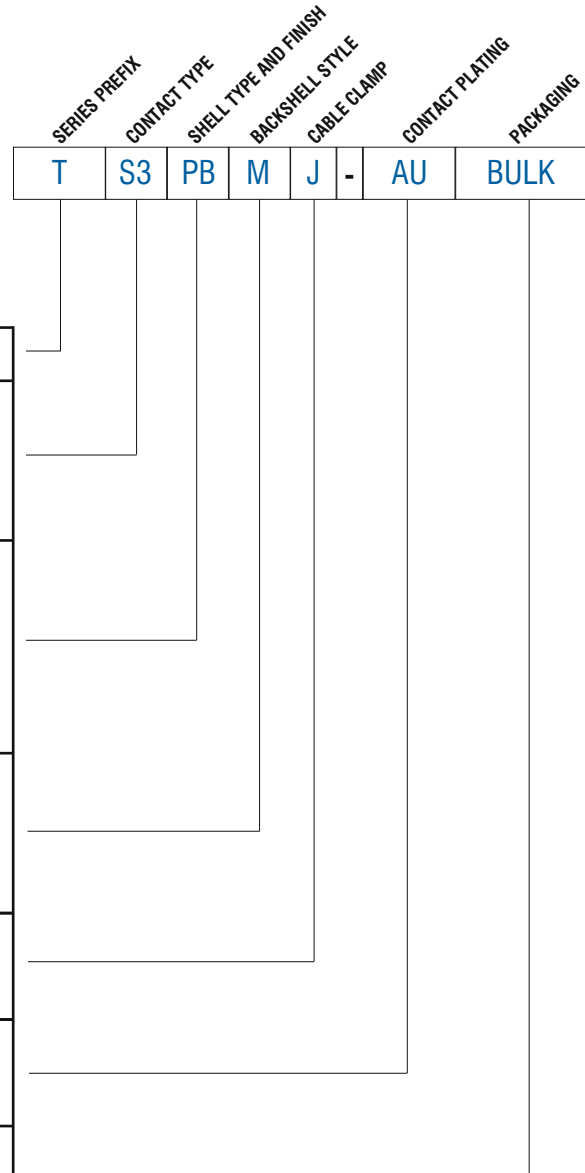

SERIES PREFIX	T	=	Series Prefix
CONTACT TYPE	M1	=	Switch Plug
	M2	=	2 Pole (mono)
	S3	=	3 Pole, tip/ring/sleeve (stereo)
SHELL TYPE AND FINISH	P	=	Plug Satin Nickel
	PB	=	Plug Matt Black
	R	=	Right Angle Plug Satin Nickel
	RB	=	Right Angle Plug Matt Black
BACKSHELL TYPE	Blank	=	Plastic Nut
	M	=	Metal Nut - Black
	N	=	Metal Nut - Satin Nickel
CABLE CLAMP	Blank	=	Small Jaws
	J	=	Large Jaws
CONTACT PLATING	Blank	=	Nickel Plated Contacts (Standard)
	AU	=	Gold Plated Contacts
PACKAGING	Blank	=	Individual Bags
	BULK	=	Bulk Packed

ISO VIEW OF TM2P

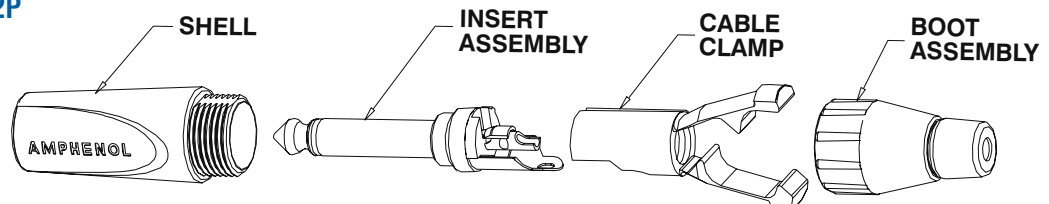

1/4" PHONE PLUG TECHNICAL DATA

		VALUE		
		Straight	Right Angle	Jumbo
GENERAL CHARACTERISTICS	Number of Contacts	3 Pole Tip Ring Sleeve (Stereo)		
	Termination	Solder		
	Max. Wire Gauge - Stranded Wire	2 Pole (Mono): AWG 16 - 1.5mm ² 3 Pole (Stereo): AWG 18 - 1mm ²		
	Flammability rating of insulating plastics	UL94V-0		
	Solderability, complies with	IEC 68-2-20		
	Environmental	Complies with EU RoHS 2 Directive 2011/65/EU		
ELECTRICAL CHARACTERISTICS	Current Carrying Capacity	10A (Depends on Mating Connector and Cable)		
	Typical Contact Resistance	Depends on Mating Connector		
	Insulation resistance (initial)	>2GΩ		
	After Damp Heat Test	≥1GΩ		
	Dielectric Withstand Voltage	2 Pole : 1.5 kV dc 3 Pole : 1 kV dc		
CLIMATIC CHARACTERISTICS	Protection Class	IP40		
	Operating Temperature	-25°C to +75°C (-13°F to + 167°F)		
MECHANICAL CHARACTERISTICS	Insertion and Withdrawal Force	≥10N - ≤30N		
	Weight ¹⁾ - Thermoplastic Backshell	28g (0.061lb)		
	Weight ¹⁾ - Metal Backshell	35g (0.077lb)		
	Typical Cable Retention Force	22kg to 44kg (50lb to 100lb) - Dependent on cable material and diameter.		
	Cable O.D. - Standard Jaw	3mm to 6mm (0.118" to 0.236")	3mm to 5.5mm (0.118" to 0.216")	NA
	Cable O.D. - Large Jaw	6mm to 7mm (0.236" to 0.275")	5.5mm to 6.5mm (0.216" to 0.255")	NA
	Cable O.D. - Jumbo	NA	NA	7.5mm to 10.5mm (0.295" to 0.413")
	Mechanical Operations	1000		
MATERIALS	Connector Shell Material	Diecast Zinc Alloy EZDA No.3		
	Shell Finish	Satin Nickel or Black Polyester		
	Insulators	UL94 V-0 PBT Resin or Modified PPE Resin - Black		
	Boot / Backshell	UL94 V-0 PBT Resin or Modified PPE Resin - Black or Metal CuZn ³⁹ Pb ³		
	Cable Clamp	UL94 V-0 PBT Modified PPO Resin - Black		
	Cable Bushing	Santoprene		
	Contacts / Plating	Brass/Ni or Au over 2μm Ni		

Rev 5 - 03/2013

¹⁾ Approximate weight only, does not include packaging. Please contact us for exact weight for shipping purposes.



Features:

- Mono or Stereo (TRS).
- AX Series inspired shell design.
- Large cable O.D. Entry to 8mm (0.315")
- Robust diecast shell in Satin nickel or Black finish.
- Nickel or Gold contact plating.
- Flexible grommet cable protection.
- Improved solderability.
- Precision machined contacts.
- Standard or Bulk packaging.

Clamp Info:



Cable O.D 6.5mm to 8mm (0.256" to 0.315")

Options: Black Shell, Gold contacts. Coloured grommets (ordered separately)

Specifications: Page 112







PRODUCT - FIGURE	DRAWING	DESCRIPTION	VARIATIONS	PART NUMBER
		1/4" (6.35mmø) Mono Phone plug, Diecast Shell, Satin finish, Flexible grommet.	Standard	ACPM-KN
			Gold Plated Contacts	ACPM-KN-AU
			Bulk Pack	ACPM-KN-BULK
		1/4" (6.35mmø) Mono Phone plug, Diecast Shell, Black finish, Flexible grommet.	Standard	ACPM-KB
			Gold Plated Contacts	ACPM-KB-AU
			Bulk Pack	ACPM-KB BULK
		1/4" (6.35mmø) Stereo Phone plug, Diecast Shell, Satin finish, Flexible grommet.	Standard	ACPS-KN
			Gold Plated Contacts	ACPS-KN-AU
			Bulk Pack	ACPS-KN BULK
		1/4" (6.35mmø) Stereo Phone plug, Diecast Shell, Black finish, Flexible grommet.	Standard	ACPS-KB
			Gold Plated Contacts	ACPS-KB-AU
			Bulk Pack	ACPS-KB BULK

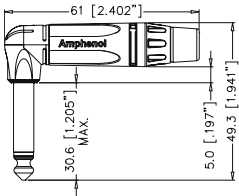

Amphenol

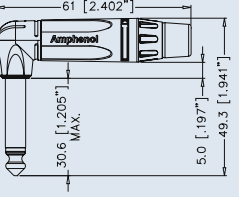
1/4" PHONE PLUGS

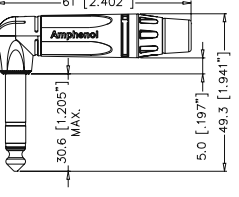
M SERIES II (MUSICIAN RANGE)

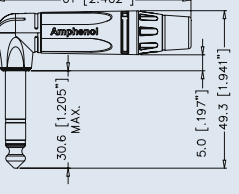
PRODUCT - FIGURE	DRAWING	DESCRIPTION	TYPE	PART NUMBER
		1/4" (6.35mmø) Mono Phone plug, Right angle, Diecast Shell, Satin finish, Flexible grommet.	Standard	ACPM-TN
			Gold contacts	ACPM-TN-AU
			Bulk Pack	ACPM-TN BULK
		1/4" (6.35mmø) Mono Phone plug, Right angle, Diecast Shell, Black finish, Flexible grommet.	Standard	ACPM-TB
			Gold contacts	ACPM-TB-AU
			Bulk Pack	ACPM-TB BULK
		1/4" (6.35mmø) Stereo Phone plug, Right angle, Diecast Shell, Satin finish, Flexible grommet.	Standard	ACPS-TN
			Gold contacts	ACPS-TN-AU
			Bulk Pack	ACPS-TN BULK
		1/4" (6.35mmø) Stereo Phone plug, Right angle, Diecast Shell, Black finish, Flexible grommet.	Standard	ACPS-TB
			Gold contacts	ACPS-TB-AU
			Bulk Pack	ACPS-TB BULK





Features:

- Mono or Stereo (TRS).
- Stylish shell design.
- Robust diecast shell in Satin nickel or Black finish.
- Nickel or Gold contact plating.
- Flexible grommet cable protection.
- Improved solderability.
- Precision machined contacts.
- Standard or Bulk packaging.
- Cable OD Entry to 6.5mm (0.256")

Clamp Info:









Cable O.D 3mm to 6.5mm (0.118" to 0.256")

Options: Black Shell, Gold contacts. Coloured grommets (ordered separately)

Specifications: page 117

PRODUCT - FIGURE	DRAWING	DESCRIPTION	VARIATIONS	PART NUMBER
	<p>Dimensions in mm (inches)</p>	1/4" (6.35mm \varnothing) Mono Phone plug, Diecast Shell, Satin finish, Flexible grommet.	Standard	ACPM-GN
			Gold Plated Contacts	ACPM-GN-AU
			Bulk Pack	ACPM-GN BULK
		1/4" (6.35mm \varnothing) Mono Phone plug, Diecast Shell, Black finish, Flexible grommet.	Standard	ACPM-GB
			Gold Plated Contacts	ACPM-GB-AU
			Bulk Pack	ACPM-GB BULK
		1/4" (6.35mm \varnothing) Stereo Phone plug, Diecast Shell, Satin finish, Flexible grommet.	Standard	ACPS-GN
			Gold Plated Contacts	ACPS-GN-AU
			Bulk Pack	ACPS-GN BULK
		1/4" (6.35mm \varnothing) Stereo Phone plug, Diecast Shell, Black finish, Flexible grommet.	Standard	ACPS-GB
			Gold Plated Contacts	ACPS-GB-AU
			Bulk Pack	ACPS-GB BULK

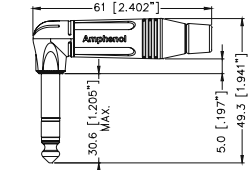

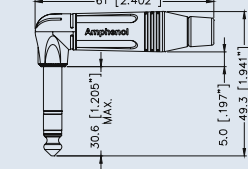
PRODUCT - FIGURE	DRAWING	DESCRIPTION	TYPE	PART NUMBER
		1/4" (6.35mmø) Mono Phone plug, Right angle, Diecast Shell, Satin finish, Flexible grommet.	Standard	ACPM-RN
			Gold contacts	ACPM-RN-AU
			Bulk Pack	ACPM-RN BULK
		1/4" (6.35mmø) Mono Phone plug, Right angle, Diecast Shell, Black finish, Flexible grommet.	Standard	ACPM-RB
			Gold contacts	ACPM-RB-AU
			Bulk Pack	ACPM-RB BULK
		1/4" (6.35mmø) Stereo Phone plug, Right angle, Diecast Shell, Satin finish, Flexible grommet.	Standard	ACPS-RN
			Gold contacts	ACPS-RN-AU
			Bulk Pack	ACPS-RN BULK
		1/4" (6.35mmø) Stereo Phone plug, Right angle, Diecast Shell, Black finish, Flexible grommet.	Standard	ACPS-RB
			Gold contacts	ACPS-RB-AU
			Bulk Pack	ACPS-RB BULK



PART NUMBER BREAKDOWN

M / M SERIES II (MUSICIAN RANGE)

E. G. **ACPM-GB-AU BULK**
ACP (Series Prefix), **M**ale, **G**(Shell Type), **B**lack,
 - **AU** (Gold Plated Contacts), **BULK** Packaged.

SERIES PREFIX	ACP = Series Prefix
CONTACT TYPE	M = 2 pole (Mono) S = 3 pole Tip/Ring/Sleeve (Stereo)
SHELL TYPE	G = M Series Straight K = M Series II Straight R = M Series Right Angle T = M Series II Right Angle
SHELL FINISH	N = Satin Nickel B = Matt Black
CONTACT PLATING	Blank = Nickel Plating AU = Gold Plated
PACKAGING	Blank = Individual Bags BULK = Bulk Packed

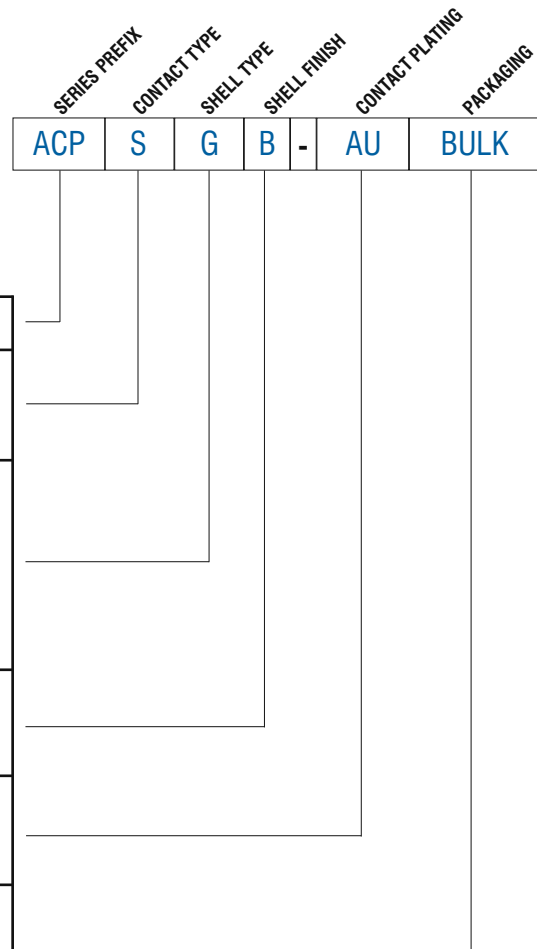



1/4" PHONE JACK CONNECTORS

Amphenol phone connectors are available in 1/4" (6.35mm) and 3.5mm jack sockets or dual jack socket versions featuring combinations of both sizes. The standard heavy duty contacts provide excellent signal performance and the rugged designs excel in professional audio applications. Our wide range of options ensures we have the connector to suit your specific requirements. Custom jacks can also be developed to suit unique applications on request.

Applications

- Audio Cables and Snakes
- Amplifiers
- Speakers
- Mixing desks
- Rack mount equipment
- Patch panel

Features / Options – OEM RANGE Phone Jack

- Mono or Stereo (TRS)
- Stackable (Piggy back) mounting
- Vertical or horizontal PCB mount
- Mono and Stereo switched contacts
- Solder contacts
- Combo Contacts
- Metal nut
- Plastic Nut
- 1/4" (6.35mm)
- 3.5mm
- Dual 1/4" (6.35mm) and 3.5mm
- EMI Shielding plates
- Metal Mounting threads
- Plastic Mounting threads
- Chassis Ground connections
- Half, Full or No threads
- Grounded or Isolated Jacks

1/4" Phone Jack Grounding/ Shielding Options

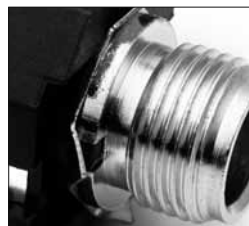

1/4" Gripper - Grounding points

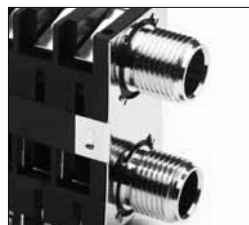

1/4" Shielding Plate

Ordering Codes

We have listed the more common ordering codes in each section. Please contact us if you need any further assistance.

Simple steps to guide you in using this catalogue

- 1) Identify the product group listed in Contents on page 1 and go directly to that page number.
- 2) Each product group cover page then details information and options available.
- 3) Refer to the product detail pages and identify the product you require pictorially.
- 4) Read the product description column for the products standard features.
- 5) Use variations column to determine your choice.
- 6) Identify part number.
- 7) In the event the particular option you require is not listed please refer to the part number breakdown page at the end of each section.
- 8) Please contact us directly if you have any further problems.



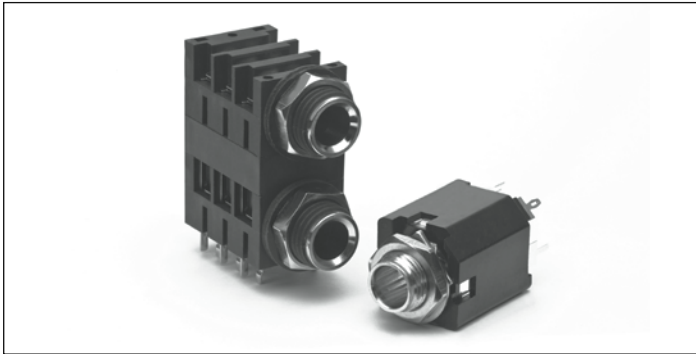

Features:

- 3.5mm and 6.35mm (1/4") options
- Mono or Stereo (TRS)
- Single or Dual mounting
- Vertical or Horizontal PCB mount
- Mono and Stereo with switching contacts
- Solder or Combo contacts
- Various mounting option

Schematic Chart: page 117

Panel Cutouts: page 114

PCB Footprints: page 116

Specifications: page 117

PRODUCT - FIGURE	DRAWING	DESCRIPTION	VARIATIONS	PART NUMBER
3.5MM PHONE JACKS				
		3.5mm Jack, Horizontal PCB, Plastic housing, Metal entry bore	Mono	ACJM-NH35
			Stereo	ACJS-NH35
		3.5mm Jack, Vertical PCB mount, Needle eye contacts, Plastic housing, Metal entry bore	Refer to Schematic Chart on Page 110	ACJM-NV35-2 ACJM-NV35-2S ACJS-NV35-3 ACJS-NV35-3S ACJS-NV35-5
		3.5mm Jack, Vertical PCB mount, Needle eye contacts, Plastic housing, Metal thread and entry bore	Refer to Schematic Chart on Page 110	ACJM-MV35-2 ACJM-MV35-2S ACJS-MV35-3 ACJS-MV35-3S ACJS-MV35-5
		3.5mm / 1/4" (6.35mm) Dual Phone Jack, (Piggy-back), Horizontal PCB, Plastic housing, Metal nut and entry bore	Mono	ACJM-MHD985
			Stereo	ACJS-MHD985
		3.5mm / 1/4" (6.35mm) Dual Phone Jack, Vertical PCB mount, Needle eye contacts, Plastic housing, Metal nut and entry bore	Refer to Schematic Chart on Page 110	ACJM-MVD985-2 ACJM-MVD985-2S ACJS-MVD985-3 ACJS-MVD985-3S ACJS-MVD985-5
1/4" PHONE JACKS HORIZONTAL				
		1/4" (6.35mm) Phone Jack, Horizontal Snap-fit PCB, Plastic housing, Half thread, Metal entry bore. Supplied without mounting hardware.	Mono	ACJM-HHDR
			Stereo	ACJS-HHDR

PRODUCT - FIGURE	DRAWING	Dimensions in mm (inches)	DESCRIPTION	VARIATIONS	PART NUMBER
			1/4" (6.35mmø) Phone Jack, Horizontal Snap-fit PCB, Plastic housing, Metal nut and entry bore	Mono	ACJM-MHDR
				Stereo	ACJS-MHDR
			1/4" (6.35mmø) Phone Jack, Horizontal Snap-fit PCB, Plastic housing, Metal thread, nut, washer and entry bore	Mono	ACJM-MHDRM
				Stereo	ACJS-MHDRM
			1/4" (6.35mmø) Offset Jack, Horizontal PCB mount, Plastic housing and entry bore with Half thread. Supplied without mounting hardware.	Refer to Schematic Chart on Page 110	ACJM-HHOP
					ACJS-HHOP
			1/4" (6.35mmø) Offset Jack, Horizontal PCB mount, Plastic housing and entry bore with Half thread. Supplied without mounting hardware.	Refer to Schematic Chart on Page 110	ACJM-HHOP-1
					ACJS-HHOP-1
			1/4" (6.35mmø) Offset Jack, Horizontal PCB mount, Plastic housing, thread and entry bore	Mono - Plastic Nut	ACJM-PHOP
				Mono - Metal Nut	ACJM-MHOP
				Stereo - Plastic Nut	ACJS-PHOP
				Stereo - Metal Nut	ACJS-MHOP
			1/4" (6.35mmø) Offset Jack, Horizontal PCB mount, Plastic housing, thread and entry bore. Non-switching sleeve contact with separate grounding to panel.	Refer to Schematic Chart on Page 110	ACJM-PHOP-1
				PHOP - Denotes Plastic Nut	ACJM-MHOP-1
				MHOP - Denotes Metal Nut	ACJS-PHOP-1
					ACJS-MHOP-1
			1/4" (6.35mmø) Offset Jack, Horizontal PCB mount, Plastic housing, Metal thread and entry bore with Chassis ground connection	Mono - Metal Nut	ACJM-MHOM
				Stereo - Metal Nut	ACJS-MHOM
			1/4" (6.35mmø) Jack, Horizontal PCB mount, Plastic housing with metal insert	Mono - Plastic Nut	ACJM - PH
				Mono - Metal Nut	ACJM - MH



PRODUCT - FIGURE	DRAWING	Dimensions in mm (inches)	DESCRIPTION	VARIATIONS	PART NUMBER
			1/4" (6.35mmø) Jack, Horizontal PCB mount, Plastic housing with metal insert	Stereo - Plastic Nut	ACJS - PH
				Stereo - Metal Nut	ACJS - MH
			1/4" (6.35mmø) Jack, Horizontal Snap-fit PCB mount, Plastic housing with metal insert	Mono - Plastic Nut	ACJM-PHR
				Mono - Metal Nut	ACJM-MHR
				Stereo - Plastic Nut	ACJS-PHR
				Stereo - Metal Nut	ACJS-MHR
			1/4" (6.35mmø) Jack, Combination Horizontal PCB mount and Solder lug, Plastic housing with metal insert	Mono - Plastic Nut	ACJM-PC
				Mono - Metal Nut	ACJM-MC
				Stereo - Plastic Nut	ACJS-PC
				Stereo - Metal Nut	ACJS-MC
			1/4" (6.35mmø) Jack, Solder Lug, Plastic housing with metal insert	Mono - Plastic Nut	ACJM-PHS
				Mono - Metal Nut	ACJM-MHS
				Stereo - Plastic Nut	ACJS-PHS
				Stereo - Metal Nut	ACJS-MHS
			1/4" (6.35mmø) Jack, Solder Lug, Plastic housing and Bezel with threaded Metal nut.	Mono	ACJM-IHS
				Stereo	ACJS-IHS
			1/4" (6.35mmø) Jack, Horizontal PCB mount, Plastic housing and Bezel with threaded Metal nut.	Mono	ACJM-IH
				Stereo	ACJS-IH
1/4" PHONE JACKS HORIZONTAL DUAL			1/4" (6.35mmø) Dual Phone Jack (Compact Piggyback), Horizontal Snap-fit PCB, Plastic housing, Metal nut and entry bore	Mono	ACJM-MHDC*
				Stereo	ACJS-MHDC*
Stereo	ACJS-MHDCM				

PRODUCT - FIGURE	DRAWING	Dimensions in mm (inches)	DESCRIPTION	VARIATIONS	PART NUMBER
			1/4" (6.35mmØ) Dual Phone Jack (Piggyback) Horizontal Snap-fit PCB, Plastic housing, Metal nut and entry bore	Mono Stereo	ACJM-MHD* ACJS-MHD*
			1/4" (6.35mmØ) Dual Phone Jack (Piggyback) Shielding plate, Horizontal Snap-fit PCB, Plastic housing, Metal nut and entry bore	Mono Stereo	ACJM-MHDE* ACJS-MHDE*
			1/4" (6.35mmØ) Dual Phone Jack (Piggyback), Horizontal Snap-fit PCB, Plastic housing, Metal thread, washer and entry bore	Mono Stereo	ACJM-MHDM* ACJS-MHDM*
			1/4" (6.35mmØ) Dual Phone Jack (Piggyback), Shielding plate Horizontal Snap-fit PCB, Plastic housing, Metal thread, nut and entry bore	Mono Stereo	ACJM-MHDEM* ACJS-MHDEM*
1/4" PHONE JACKS VERTICAL					
			1/4" (6.35mmØ) Jack, Vertical PCB mount, Plastic housing, nut and entry bore	Refer to Schematic Chart on Page 110	ACJM-PVB-2 ACJM-PVB-2S ACJS-PVB-3 ACJS-PVB-3S ACJS-PVB-5
			1/4" (6.35mmØ) Jack, Vertical PCB mount, Needle eye contacts, Plastic thread, Metal nut and insert	Refer to Schematic Chart on Page 110	ACJM-MIV-2 ACJM-MIV-2S ACJS-MIV-3 ACJS-MIV-3S ACJS-MIV-5
			1/4" (6.35mmØ) Jack, Vertical PCB mount, Needle eye contacts, Star washer, Metal nut and insert	Refer to Schematic Chart on Page 110	ACJM-MN-2 ACJS-MN-3 ACJM-MN-2S ACJS-MN-3S ACJS-MN-5
			1/4" (6.35mmØ) Jack, Vertical PCB mount, Metal nut and insert	Refer to Schematic Chart on Page 110	ACJM-MV-2 ACJM-MV-2S ACJS-MV-3 ACJS-MV-3S ACJS-MV-5

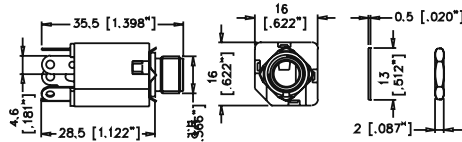

PRODUCT - FIGURE	DRAWING	DESCRIPTION	VARIATIONS	PART NUMBER
	 <p>Dimensions in mm (inches)</p>	1/4" (6.35mm) Jack, Solder Lug, Metal nut and insert	Refer to Schematic Chart on Page 110	<p>ACJM-MVS-2</p> <p>ACJM-MVS-2S</p> <p>ACJS-MVS-3</p> <p>ACJS-MVS-3S</p> <p>ACJS-MVS-5</p>

PANEL CUTOUTS

-FRONT VIEW

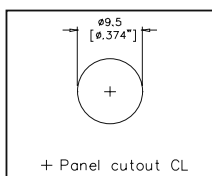

ACJM-MV
ACJS-MV
ACJM-MN-2
ACJS-MN-3
ACJM-MN-2S
ACJS-MN-3S
ACJS-MN-5
ACJM-MIV
ACJS-MIV
ACJM-MVS
ACJS-MVS

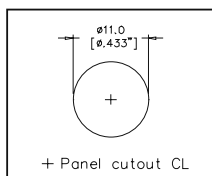

ACJM/S-PH
ACJM/S-MH
ACJM/S-PC
ACJM/S-MC
ACJM/S-PHR
ACJM/S-MHR
ACJM/S-PHS
ACJM/S-MHS

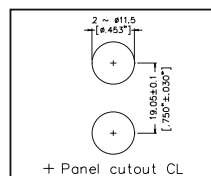

ACJM-MHD
ACJS-MHD
ACJM-MHDE
ACJS-MHDE

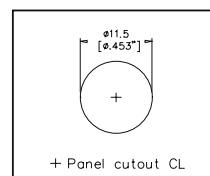

ACJM-MHDR
ACJS-MHDR
ACJS-HHDR

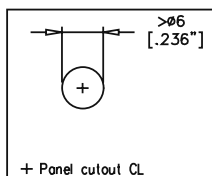

ACJM-NH35
ACJS-NH35

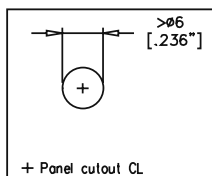

ACJM-NV35-2
ACJM-NV35-2S
ACJS-NV-35-3
ACJS-NV-35-3S
ACJS-NV-35-5
ACJM-MV35-2
ACJM-MV35-2S
ACJS-MV-35-3
ACJS-MV-35-3S
ACJS-MV-35-5

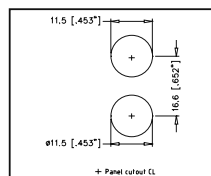

ACJS-MHDC
ACJM-MHDC

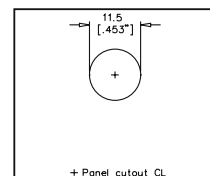

ACJS-IH
ACJM-IH
ACJS-IHS
ACJM-IHS

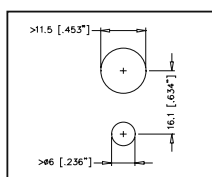

ACJS-MHD985
ACJM-MHD985

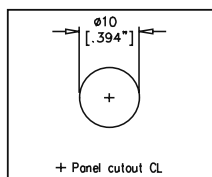

ACJS-MHOM
ACJM-MHOM

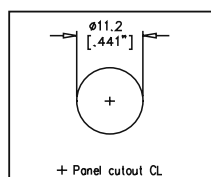

ACJS-MHOP
ACJS-PHOP
ACJM-MHOP
ACJM-PHOP
ACJS-MHOP-1
ACJS-HHOP-1
ACJS-PHOP-1
ACJM-PHOP-1
ACJM-MHOP-1
ACJM-HHOP-1
ACJM-HHOP
ACJS-HHOP

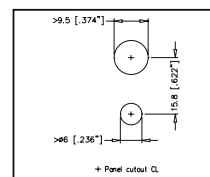

ACJS-MVD985
ACJM-MVD985

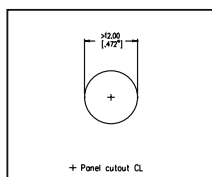

ACJM-PVB-2
ACJM-PVB-2S
ACJS-PVB-3
ACJS-PVB-3S
ACJS-PVB-5

SCHEMATIC CHART

PART NO.	ACJM-MV35-2 ACJM-MN-2 ACJM-NV35-2 ACJM-PVB-2 ACJM-MV-2 ACJM-MVS-2 ACJM-MIV-2	ACJM-MV35-2S ACJM-MN-2S ACJM-NV35-2S ACJM-PVB-2S ACJM-MV-2S ACJM-MVS-2S ACJM-MIV-2S	ACJS-MV35-3 ACJS-MN-3 ACJS-NV35-3 ACJS-PVB-3 ACJS-MV-3 ACJS-MVS-3 ACJS-MIV-3	ACJS-MV35-3S ACJS-MN-3S ACJS-NV35-3S ACJS-PVB-3S ACJS-MV-3S ACJS-MVS-3S ACJS-MIV-3S	ACJS-MV35-5 ACJS-MN-5 ACJS-NV35-5 ACJS-PVB-5 ACJS-MV-5 ACJS-MVS-5 ACJS-MIV-5
GENERAL SCHEMATIC					

PART NO.	ACJM-MVD985-2	ACJM-MVD985-2S	ACJS-MVD985-3	ACJS-MVD985-3S	ACJS-MVD985-5
SCHEMATIC					

PART NO.	ACJM-HHOP-1 ACJM-PHOP-1 ACJM-MHOP-1	ACJS-HHOP-1 ACJS-PHOP-1 ACJS-MHOP-1	ACJM-HHOP ACJM-PHOP CJM-MHOP	ACJS-HHOP ACJS-PHOP ACJS-MHOP
GENERAL SCHEMATIC				



PCB FOOTPRINT - CONNECTOR SIDE OF PCB

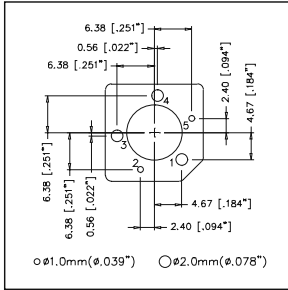

ACJM-MV
ACJS-MV
ACJM-MN-2
ACJS-MN-3
ACJM-MN-2S
ACJS-MN-3S
ACJM-MN-5
ACJS-MN-5
ACJM-NV35-XX
ACJS-NV35-XX
ACJM-MV35-XX
ACJS-MV35-XX
ACJM-MIV-2
ACJS-MIV-2S
ACJM-MIV-3
ACJS-MIV-3S
ACJM-MIV-5

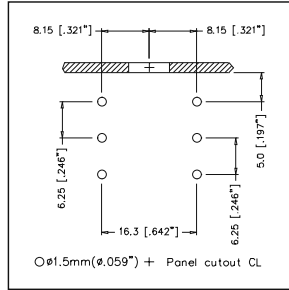

ACJM-PH
ACJS-PH
ACJM-MH
ACJS-MH
ACJM-MC
ACJS-MC

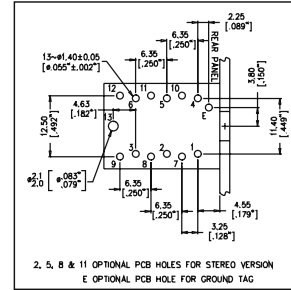

ACJM-MHD
ACJS-MHD
ACJM-MHDE
ACJS-MHDE
ACJM-MHDEM
ACJS-MHDEM
ACJM-MHDC
ACJS-MHDC
ACJM-MHDCM
ACJS-MHDCM
ACJM-MHDM
ACJS-MHDM

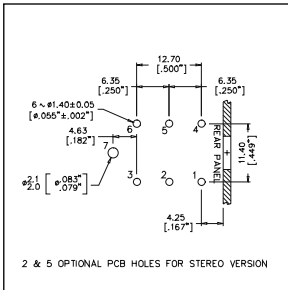

ACJM-MHDR
ACJS-MHDR
ACJM-PHR
ACJS-PHR
ACJM-MHR
ACJS-MHR
ACJM-HHDR
ACJS-HHDR
ACJM-MHDRM
ACJS-MHDRM

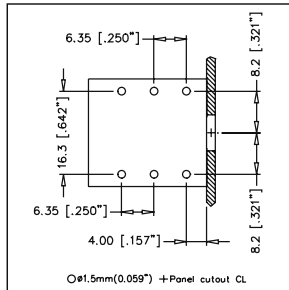

ACJS-IH
ACJM-IH

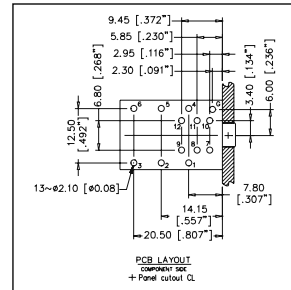

ACJS-MHD985
ACJM-MHD985

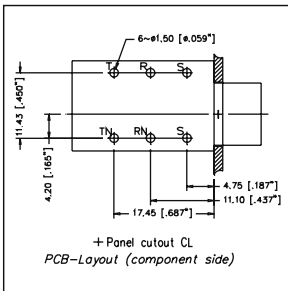

ACJS-MHOM
ACJM-MHOM

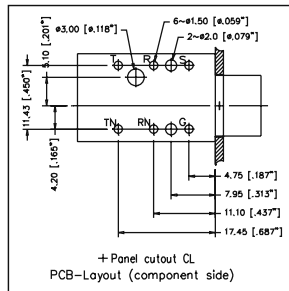

ACJS-MHOP-1
ACJM-MHOP-1
ACJS-PHOP-1
ACJM-PHOP-1
ACJS-HHOP-1
ACJM-HHOP-1

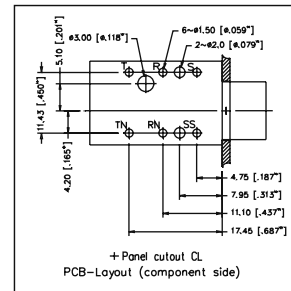

ACJS-MHOP
ACJM-MHOP
ACJS-PHOP
ACJM-PHOP
ACJS-HHOP
ACJM-HHOP

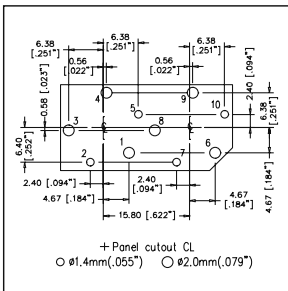

ACJS-MVD985
ACJM-MVD985

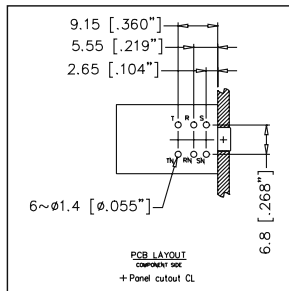

ACJS-NH35
ACJM-NH35

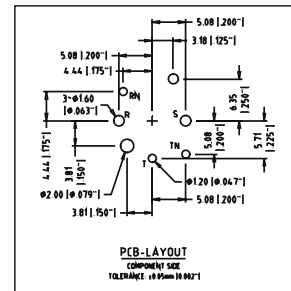

ACJM-PVB-2
ACJS-PVB-2S
ACJM-PVB-3
ACJS-PVB-3S
ACJM-PVB-5
ACJS-PVB-5

PLUG AND JACKS TECHNICAL DATA

		VALUE
GENERAL CHARACTERISTICS	Number of Contacts	2 Pole (Mono) 3 Pole Tip Ring Sleeve (Stereo)
	Termination	Solder, PCB or Combo
	Max. Wire Gauge - Stranded Wire	2 Pole (Mono): AWG 16 - 1.5mm ² 3 Pole (Stereo): AWG 18 - 1mm ²
	Flammability rating of insulating plastics	UL94V-0
	Solderability, complies with	IEC 68-2-20
	Environmental	Complies with EU RoHS 2 Directive 2011/65/EU
ELECTRICAL CHARACTERISTICS	Current Carrying Capacity	10A (Depends on Mating Connector and Cable)
	Typical Contact Resistance	Depends on Mating Connector
	Insulation resistance (initial)	>2GΩ
	After Damp Heat Test	≥1GΩ
	Dielectric Withstand Voltage	2 Pole : 1.5 kV dc 3 Pole : 1 kV dc
CLIMATIC CHARACTERISTICS	Protection Class	IP40
	Operating Temperature	-25°C to +75°C (-13°F to + 167°F)
MECHANICAL CHARACTERISTICS	Insertion and Withdrawal Force	≥10N - ≤30N
	Cable O.D. (Plugs)	6mm (0.236")
MATERIALS	Connector Shell Material (Plugs)	Diecast Zinc Alloy EZDA No.3
	Connector Shell Material (Jacks)	UL94 V-0 PBT Modified PPO Resin - Black
	Connector Shell Finish	Satin Nickel, Nickel or Black Polyester
	Insulators	UL94 V-0 PBT Resin or Modified PPE Resin and fibreglass laminate
	Cable Bushing	Santoprene
	Contacts / Plating (Plugs) Contacts / Plating (Jacks)	Brass / Ni over Cu (Copper) Brass / Sn (Tin) over Cu (Copper)

Rev 3 - 03-2013

¹⁾ Approximate weight only, does not include packaging. Please contact us for exact weight for shipping purposes.





PLUGS AND SOCKETS

Amphenol's plugs and sockets range continually expands to meet the needs of our customers. The success of the M-Series phone plugs led to the RCA series being developed. The Miniature XLR range was a natural progression from our standard XLR series as demand for smaller interconnects increased. The latest addition to the range is a professional grade 3.5mm phone plug designed for applications that require a robust interconnect.

Applications

- Audio Cables and Snakes
- Amplifiers
- Speakers
- Mixing desks
- Rack mount equipment
- Patch panel

Features / Options – RCA Plugs and Jacks

- Red, Black, White, Yellow, Blue or Green shell colours
- Stylish shell design
- Flexible grommet cable protection
- Gold Plated Contacts

Features / Options – Miniature XLR

- 3,4,5, or 6 contacts
- Solder cup
- Printed Circuit Board
- Vertical or Horizontal mounting
- Positive locking latch
- Flexible cable clamp
- Metal cable clamp
- Locking rings
- Chassis front mount
- Chassis middle or rear mount (on request)
- Optional black finish (on request)

Features / Options – 3.5mm Plugs Phone Jack

- Mono / Stereo TRS
- Solder contacts
- Suits cable O.D 2.5mm to 5mm
- Stylised shell design
- Flexible cable grommet
- Metal cable clamp
- Nickel or Gold contact plating
- Satin Nickel or Black finish

Cable Clamp Options



RCA Cable Clamp - M-Series, Cable O.D 3mm to 6.5mm (0.118" to 0.256")

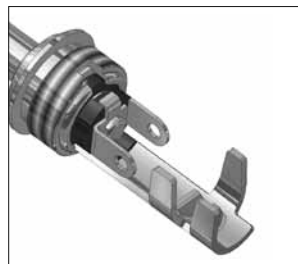

K-Series, Cable O.D 3mm to 5mm (0.118" to 0.196")

Ordering Codes

We have listed the more common ordering codes in each section. Please contact us if you need any further assistance.

Simple steps to guide you in using this catalogue

- 1) Identify the product group listed in Contents on page 1 and go directly to that page number.
- 2) Each product group cover page then details information and options available.
- 3) Refer to the product detail pages and identify the product you require pictorially.
- 4) Read the product description column for the products standard features.
- 5) Use variations column to determine your choice.
- 6) Identify part number.
- 7) In the event the particular option you require is not listed please refer to the part number breakdown page at the end of each section.
- 8) Please contact us directly if you have any further problems.





Features:

- Mono or TRS (Stereo).
- AX Series inspired shell design.
- Suits Cable O.D from 2.5mm to 5mm (0.098" to 0.196")
- Robust diecast shell in Satin nickel or Black finish.
- Nickel or Gold contact plating.
- Flexible grommet cable protection.
- Improved solderability.
- Precision machined contacts.
- Standard or Bulk packaging.

Options: Black Shell, Gold contacts.

PRODUCT - FIGURE	DRAWING	DESCRIPTION	VARIATIONS	PART NUMBER
	<p>Dimensions in mm (inches)</p>	3.5mm, Mono Phone plug, Diecast Shell, Satin finish, Flexible grommet.	Standard Gold Plated Contacts Bulk Pack	KM2P KM2P-AU KM2P BULK
		3.5mm, Mono Phone plug, Diecast Shell, Black finish, Flexible grommet.	Standard Gold Plated Contacts Bulk Pack	KM2PB KM2PB-AU KM2PB BULK
		3.5mm, Stereo Phone plug, Diecast Shell, Satin finish, Flexible grommet.	Standard Gold Plated Contacts Bulk Pack	KS3P KS3P-AU KS3P BULK
		3.5mm, Stereo Phone plug, Diecast Shell, Black finish, Flexible grommet.	Standard Gold Plated Contacts Bulk Pack	KS3PB KS3PB-AU KS3PB BULK
		3.5mm, Stereo Phone plug with extended shaft for mobile phones fitted with covers. Diecast Shell, Black Chrome finish, Flexible grommet	Standard Gold Plated Contacts	KS3PC KS3PC-AU



PART NUMBER BREAKDOWN

K-SERIES

E. G. **KS3P-AU BULK**
K (Series Prefix), **S3** (Stereo), Plug,
AU (Gold Plated Contacts), **Bulk** Packaged.

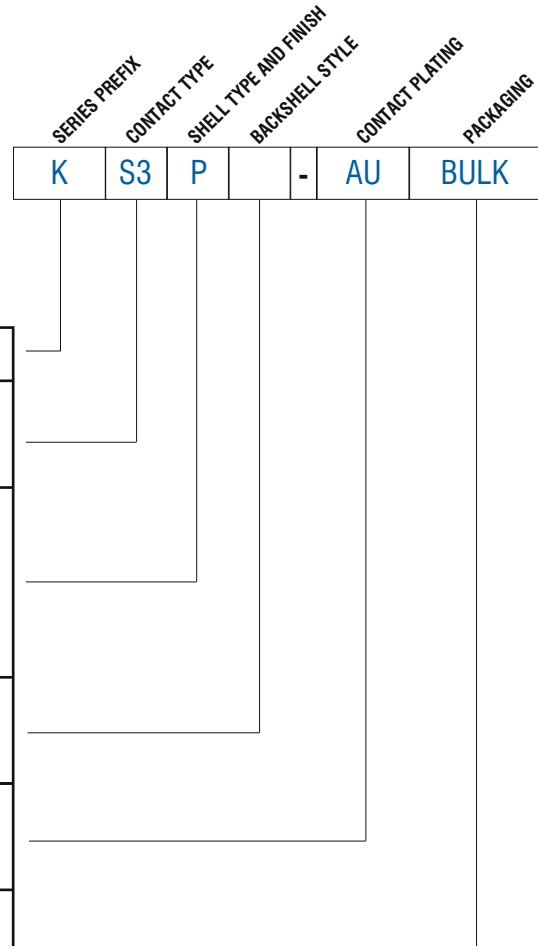

SERIES PREFIX	K	=	Series Prefix
CONTACT TYPE	M2	=	2 Pole (mono)
	S3	=	3 pole TRS (Stereo)
SHELL TYPE AND FINISH	P	=	Plug Satin Nickel
	PB	=	Plug Matt Black
	PC	=	Plug Black Chrome
BACKSHELL TYPE AND CABLE CLAMP	Blank	=	K Series to suit Cable O.D 2.5mm to 5mm (0.098" to 0.196")
CONTACT PLATING	Blank	=	Nickel Plated Contacts (Standard)
	AU	=	Gold Plated Contacts
PACKAGING	Blank	=	Individual Bags
	BULK	=	Bulk Packed

ISO VIEW OF KS3P

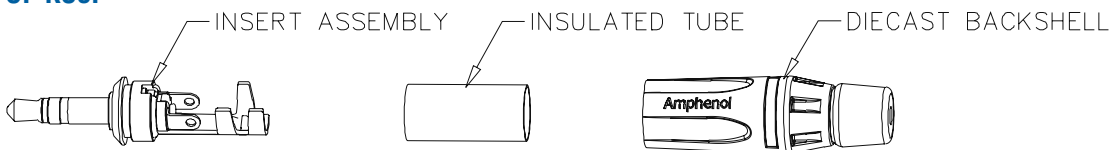

Amphenol

PLUGS AND SOCKETS

RCA SERIES



Features:

- Stylish design
- Flexible grommet cable protection
- Robust diecast shell
- Gold plated contacts
- Colour coded
- Good solderability
- Quick and easy assembly
- Panel mount utilises standard 'D' type housing

Part Number Breakdown: [page 122](#)

PRODUCT - FIGURE	DRAWING	Dimensions in mm (inches)	DESCRIPTION	COLOUR	PART NUMBER
		62 [2.445"] ø13.8 [.543"]	RCA Plug, Diecast Shell, Gold plated contacts, Coloured finish, Flexible coloured grommet.	Red	ACPR-RED
				Black	ACPR-BLK
				Yellow	ACPR-YEL
				White	ACPR-WHT
				Blue	ACPR-BLU
		62 [2.445"] ø13.8 [.543"]	RCA Plug, Diecast Shell, Gold plated contacts, Satin finish, Flexible coloured grommet.	Satin / Red	ACPR-SRD
				Satin / Black	ACPR-SBK
				Satin / Yellow	ACPR-SYL
				Satin / White	ACPR-SWH
				Satin / Blue	ACPR-SBL
		54 [2.130"] ø13.8 [.543"]	RCA Jack, Diecast Shell, Gold plated contacts, Coloured finish, Flexible coloured grommet.	Red	ACJR-RED
				Black	ACJR-BLK
				Yellow	ACJR-YEL
				White	ACJR-WHT
				Blue	ACJR-BLU
		54 [2.130"] ø13.8 [.543"]	RCA Jack, Diecast Shell, Gold plated contacts, Satin finish, Flexible coloured grommet.	Satin / Red	ACJR-SRD
				Satin / Black	ACJR-SBK
				Satin / Yellow	ACJR-SYL
				Satin / White	ACJR-SWH
				Satin / Blue	ACJR-SBL
		50.5 [1.988"] ø13.8 [.543"]	RCA Plug, Shortened Diecast Shell, Gold plated contacts, Black Chrome finish, Flexible coloured grommet.	Red	ACPL-CRD
				Black	ACPL-CBK
				Yellow	ACPL-CYL
				White	ACPL-CWH
				Blue	ACPL-CBL
				Green	ACPL-CGR

NOTE: RCA Series comply with EU RoHS 2 Directive 2011/65/EU

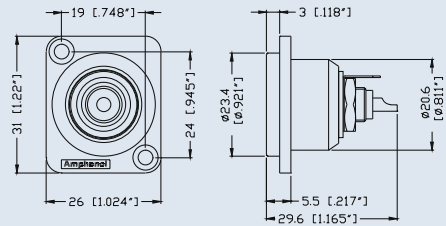

		RCA Jack, Diecast Shell, Gold plated contacts, Nickel finish shell, coloured insulator.	Red	ACJD-RED
			Black	ACJD-BLK
			Yellow	ACJD-YEL
			White	ACJD-WHT
			Blue	ACJD-BLU
			Green	ACJD-GRN

NOTE: RCA Series comply with EU RoHS 2 Directive 2011/65/EU

PART NUMBER BREAKDOWN

M SERIES RCA

E. G. **ACPR-RED BULK**
AC (Series Prefix), **P** (Plug), **R** (Shell type), **RED** (Shell and Grommet Colour), **Bulk** Packaged.

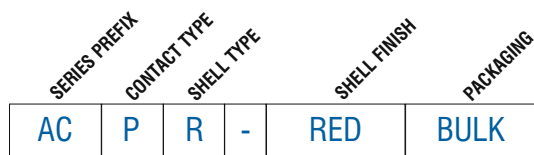

SERIES PREFIX	AC	=	Series Prefix
CONTACT TYPE	J	=	RCA Female Jack
	P	=	RCA Male Plug
SHELL TYPE	R	=	Regular Shell Length
	L	=	Short Shell Length
	D	=	Chassis Jack 'D' Shell
SHELL AND GROMMET COLOUR	RED	=	Red, Red Grommet
	BLK	=	Black, Black Grommet
	YEL	=	Yellow, Yellow Grommet
	WHT	=	White, White Grommet
	BLU	=	Blue, Blue Grommet
	GRN	=	Green, Green Grommet
	SRD	=	Satin Nickel, Red Grommet
	CRD	=	Black Chrome, Red Grommet
	SBK	=	Satin Nickel, Black Grommet
	CBK	=	Black Chrome, Black Grommet
	SYL	=	Satin Nickel, Yellow Grommet
	CYL	=	Black Chrome, Yellow Grommet
	SWH	=	Satin Nickel, White Grommet
	CWH	=	Black Chrome, White Grommet
	SBL	=	Satin Nickel, Blue Grommet
	CBL	=	Black Chrome, Blue Grommet
SGR	=	Satin Nickel, Green Grommet	
CGR	=	Black Chrome, Green Grommet	
NOTE: Denotes colour of insulator only on shell type D, Chassis Jack 'D' Shell. Shell finish is Nickel.			
PACKAGING	Blank	=	Individual Bags
	BULK	=	Bulk Packed





Features:



- Miniature version of the standard XLR series
- Diecast or Precision machined metal housings
- Metal cable clamp
- Precision machined pin contacts
- Stamped socket contacts
- Solder cup or Printed Circuit board contacts
- Available in 3, 4, 5 or 6 contacts
- Postive latchlock
- Flexible cable grommet

Part Number Breakdown: page 124 Specifications: page 125
PCB Footprints: page 126 Panel Cutouts: page 126

PRODUCT - FIGURE	DRAWING	DESCRIPTION	VARIATIONS	PART NUMBER
		Male cable connector, Machined contacts, Nickel Finish	3 pole 4 pole 5 pole 6 pole	AG3M AG4M AG5M AG6M
		Female cable connector, Stamped contacts, Nickel Finish	3 pole 4 pole 5 pole 6 pole	AG3F AG4F AG5F AG6F
		Female cable connector with locking ring, Stamped contacts, Nickel Finish.	3 pole 4 pole 5 pole 6 pole	AG3FL AG4FL AG5FL AG6FL
		Male chassis connector, Machined contacts, Nickel Finish	3 pole 4 pole 5 pole 6 pole	AG3MCC AG4MCC AG5MCC AG6MCC
		Female chassis connector, Stamped contacts, Nickel Finish	3 pole 4 pole 5 pole 6 pole	AG3FCE AG4FCE AG5FCE AG6FCE
		Male chassis connector, Horizontal PCB, Machined contacts, Nickel Finish	3 pole 4 pole 5 pole 6 pole	AG3MCCH AG4MCCH AG5MCCH AG6MCCH
		Female chassis connector, Horizontal PCB, Stamped contacts, Nickel Finish	3 pole 4 pole 5 pole 6 pole	AG3FCCH AG4FCCH AG5FCCH AG6FCCH



Amphenol

		<p>Male chassis connector, Horizontal PCB, Machined contacts, Thermoplastic shell</p>	<p>4 pole</p>	<p>AG4MPCH</p>
		<p>Female chassis connector, Stamped contacts, Nickel Finish</p>	<p>3 pole</p>	<p>AG3FCRV</p>
			<p>4 pole</p>	<p>AG4FCRV</p>
			<p>5 pole</p>	<p>AG5FCRV</p>
			<p>6 pole</p>	<p>AG6FCRV</p>

PART NUMBER BREAKDOWN

G TYPE CONNECTORS

E. G. **AG3MCCHB**
AG (Series Prefix), **3** contacts, **Male**, **Chassis Connector**, **Horizontal PCB Contacts**, **Black** finish.

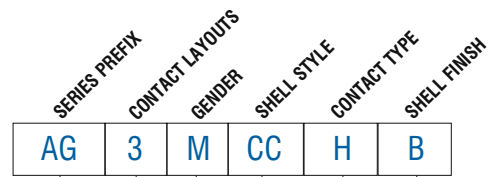

SERIES PREFIX	AG	=	Series Prefix
CONTACT LAYOUTS	3	=	3 Contacts
	4	=	4 Contacts
	5	=	5 Contacts
	6	=	6 Contacts
GENDER	F	=	Female Socket Contacts
	M	=	Male Pin Contacts
	Blank	=	Cable Connector Standard (Male or Female)
SHELL STYLE	J	=	Cable Connector Large Cable clamp / boot O.D (Male or Female)
	L	=	Cable Connector with locking ring (Female)
	LL	=	Latchless (Chassis Connector)
	CC	=	Chassis Connector Circular Metal (Male)
	CE	=	Rear Mount (Chassis Connector)
	CM	=	Mid Mount (Chassis Connector)
	CR	=	Chassis Connector Rectangular Metal (Female)
	PC	=	Chassis Connector Plastic (Male)
	Blank	=	Solder Buckets (All styles except PC, CR)
CONTACT TYPE	H	=	Horizontal PCB (Style CC, PC only)
	V	=	Vertical PCB (Style CR only)
	Blank	=	Nickel Plated Finish
SHELL FINISH	B	=	Black Finish

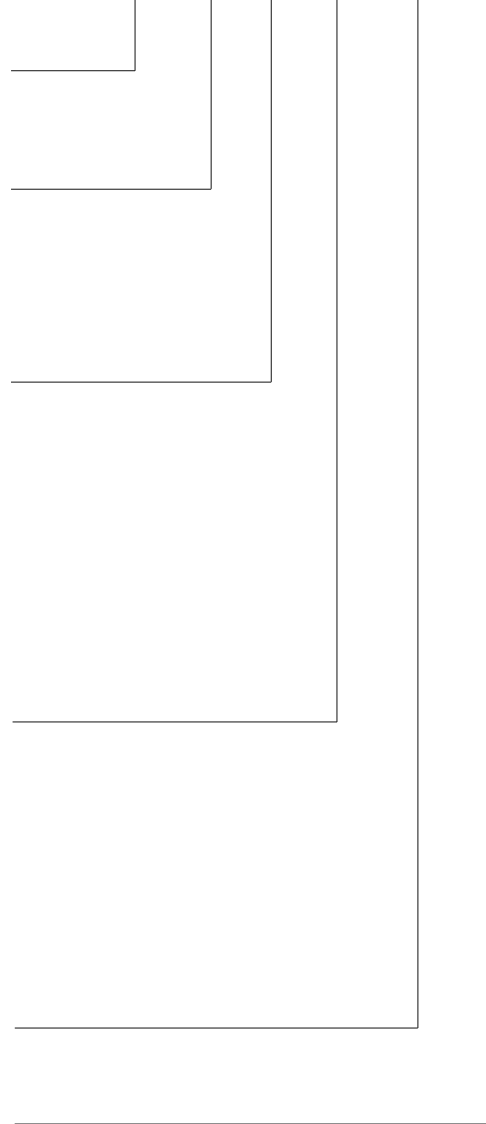

STANDARD DATA G TYPE

		VALUE			
GENERAL CHARACTERISTICS	Number of contacts	3	4	5	6
	Termination	Printed Circuit Board (PCB) or Solder Bucket			
	Flammability	UL94V-0			
	Environmental	Complies with EU RoHS 2 Directive 2011/65/EU			
ELECTRICAL CHARACTERISTICS	Service Voltage RMS ¹⁾	1000V	1000V	1000V	250V
	Test Voltage AC RMS	125V AC			
	Current carrying capacity	5A	5A	4A	1.2A
	Typical Contact Resistance	≤10mΩ			
	Insulation Resistance (initial)	≥510MΩ			
	Insulation Resistance (After damp heat test)	≥10MΩ			
CLIMATIC CHARACTERISTICS	Protection Class	IP00			
	Operating Temperature	-30 °C to +80 °C (-20F - +176F)			
MECHANICAL CHARACTERISTICS	Weight **	13.5g (0.029lb)			
	Insertion Spring Separating Force	≥20N			
	Mechanical Operations	5000 mating cycles	5000 mating cycles	5000 mating cycles	2000 mating cycles
	Cable O.D. range	2mm to 3.5mm (0.078" to 0.137")		3mm to 5mm (0.118" to 0.196")	
MATERIALS	Connector Shell	Bronze & Zinc			
	Shell Finish	Nickel Plated			
	Insulators	PPS - Black			
	Male Contact - Material	Brass C3604			
	- Plating	Gold over Silver plated			
	Female Contact - Material	Brass C5210P			
	- Plating	Gold over Silver plated			
	Latch Lock and Spring	SUS (AISI - 301) - Nickel Plated			
	Adaptor	PPS - Black			
	Cable Clamp	Bronze - Nickel Plated			
Boot/Backshell	ABS - Black				
Grommet	PU - Black				

**Approximate weight in grams not include packaging. Please contact us for exact weight for shipping purposes.

PANEL CUTOUTS - CONNECTOR SIDE OF PCB

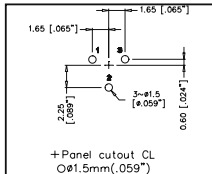

AG3MCC

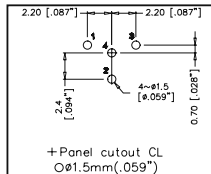

AG4MCC

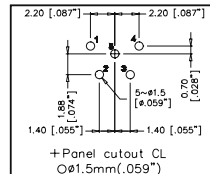

AG5MCC

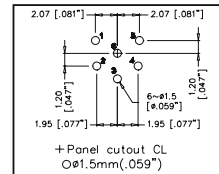

AG6MCC

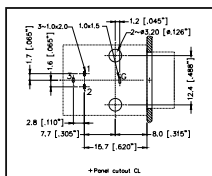

AG3MCC
AG3FCCH

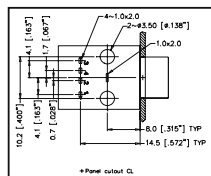

AG4MCC
AG4FCCH

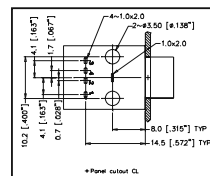

AG5MCC
AG5FCCH

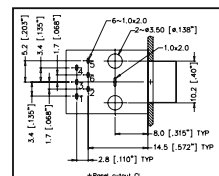

AG6MCC
AG6FCCH

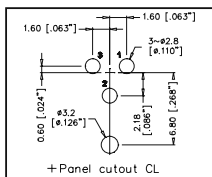

AG3FCRV

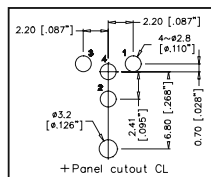

AG4FCRV

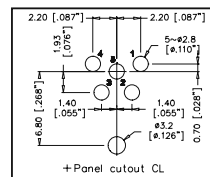

AG5FCRV

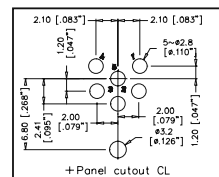

AG6FCRV

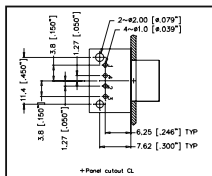

AG4MPCH

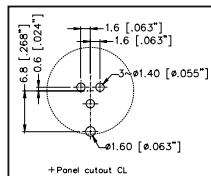

AG3FCE

PANEL CUTOUTS - FRONT VIEW

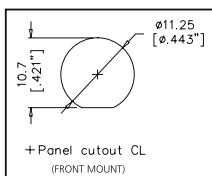

AG3MCC
AG4MCC
AG5MCC
AG6MCC

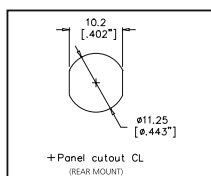

AG3MCC
AG4MCC
AG5MCC
AG6MCC
AG4MPCH

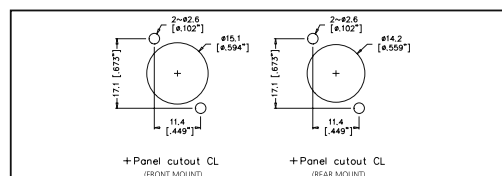

AG3FCRV
AG4FCRV
AG5FCRV
AG6FCRV



MULTIPIN CONNECTORS

Amphenol has an extensive range of circular and rectangular multi-pin connectors ideally suited to the entertainment industry. Featuring rugged housings and precision made contacts these connectors have proven themselves in the most demanding of applications. The extensive arrangement of different connector sizes and contact numbers ensure we can offer a solution to your multi-pin wiring applications.

Applications

- Audio Cables and Snakes
- Lighting control
- Concert Touring Systems
- Outside Broadcast Systems

Features / Options - MP-41 Series

- 13 to 85 pins with Crimp / Solder bucket contacts
- 150 pins with Crimp contacts only
- 4 to 48 channel
- Gold plated contacts
- Synthetic inserts
- Environmental resistant
- Positive Bayonet locking
- PG cable gland
- 2000 mating cycles
- Bayonet wear pins
- Extended coupling ring
- Metal Housings

Features / Options - MP-62 Series

- 39 or 61 Solder bucket contacts
- Gold plated contacts
- Neoprene inserts
- Environmental resistant
- Positive Bayonet locking
- PG cable gland or NPT thread
- Metal Housings

Ordering Codes

We have listed the more common ordering codes in each section. For further options please contact us.

Simple steps to guide you in using this catalogue

- 1) Identify the product group listed in Contents on page 1 and go directly to that page number.
- 2) Each product group cover page then details information and options available.
- 3) Refer to the product detail pages and identify the product you require pictorially.
- 4) Read the product description column for the products standard features.
- 5) Use pins column to determine number of contacts.
- 6) Identify part number.
- 7) In the event the particular option you require is not listed please refer to the part number breakdown page at the end of each section.
- 8) Please contact us directly if you have any further problems.







Amphenol's MP-41 series of multipin connectors utilise the same design principals of the rugged Mil-C-5015 military connectors. They can withstand high shock and vibration environments and are ideal for tough on-road applications. Featuring a quick mating bayonet coupling with an audible full mating feature ensures a positive connection every time. Available from 13 to 150 pins with contacts supplied with each connector as standard.

Features:

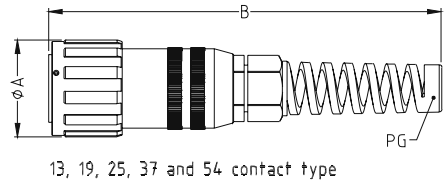
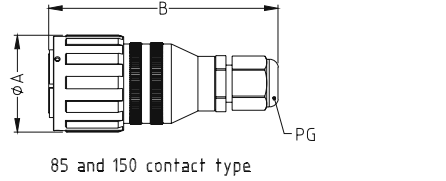

- 13 to 85 pins with Crimp/Solder bucket contacts
- 150 pins with Crimp contacts only
- 4 to 48 channels
- Gold plated contacts
- Synthetic insert
- Protective dust caps
- Industry standard compatible
- 2000 mating cycles
- Black finish
- Positive bayonet locking
- PG cable glands
- IP67 rated
- Metal housings

Options: NPT threaded backshells.

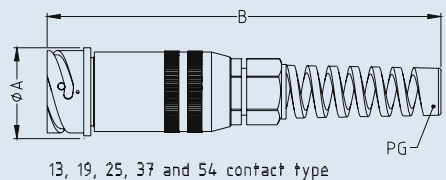
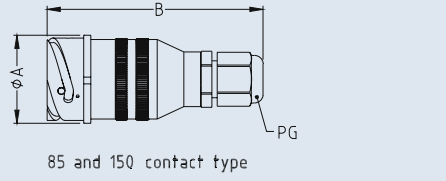

Specifications: page 132 **Crimp Tooling:** page 131
Part Number Breakdown: page 131
Wiring Information: 141

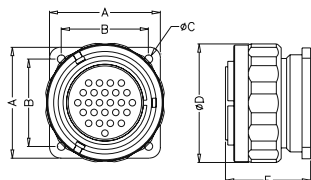
PRODUCT - FIGURE	Dimensions in mm (inches) DRAWING	Dimensions in mm (inches)			PINS	PART NUMBER	PART NUMBER With Dustcap
		A	B	PG			
	Straight cable plug with socket contacts, Black finish, supplied complete with contacts.  13, 19, 25, 37 and 54 contact type  85 and 150 contact type	40.5 (1.60)	160 (6.30)	11	13	MP-4106-13S	MP-4106-13S-C
		44 (1.73)	171 (6.73)	13.5	19	MP-4106-19S	MP-4106-19S-C
		46.6 (1.83)	193 (7.60)	16	25	MP-4106-25S	MP-4106-25S-C
		54.3 (2.14)	210 (8.26)	21	37	MP-4106-37S	MP-4106-37S-C
		60.1 (2.36)	210 (8.26)	21	54	MP-4106-54S	MP-4106-54S-C
		73.3 (2.88)	137 (5.40)	29	85	MP-4106-85S	MP-4106-85S-C
		73.3 (2.88)	145 (5.70)	36	150	MP-4106-150S	MP-4106-150S-C
	Cable connecting receptacle with pin contacts, black finish, supplied complete with contacts.  13, 19, 25, 37 and 54 contact type  85 and 150 contact type	37.8 (1.49)	160 (6.30)	11	13	MP-4101-13P	MP-4101-13P-C
		41.1 (1.62)	171 (6.73)	13.5	19	MP-4101-19P	MP-4101-19P-C
		41.5 (1.63)	193 (7.60)	16	25	MP-4101-25P	MP-4101-25P-C
		51 (2.00)	210 (8.26)	21	37	MP-4101-37P	MP-4101-37P-C
		57.1 (2.25)	210 (8.26)	21	54	MP-4101-54P	MP-4101-54P-C
		70 (2.75)	137 (5.40)	29	85	MP-4101-85P	MP-4101-85P-C
		70 (2.75)	145 (5.70)	36	150	MP-4101-150P	MP-4101-150P-C

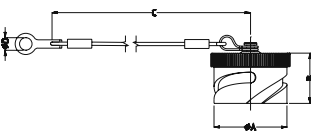
Note: NPT threaded backshells available on request. Please contact us.

PRODUCT - FIGURE	Dimensions in mm (inches) DRAWING	Dimensions in mm (inches)						PINS	PART NUMBER	PART NUMBER With Dustcap
		A	B	C	D	E	F			
	<p>Panel plug with socket contacts, black finish, supplied complete with contacts.</p> 	38 (1.49)	29.4 (1.15)	3.2 (0.13)	40.5 (1.60)	38.8 (1.53)	N/A	13	MP-4164-13S	MP-4164-13S-C
		41 (1.61)	31.8 (1.25)	3.2 (0.13)	44 (1.73)	38.8 (1.53)	N/A	19	MP-4164-19S	MP-4164-19S-C
		44.5 (1.75)	34.9 (1.37)	3.73 (0.14)	48.51 (1.91)	40.6 (1.60)	N/A	25	MP-4164-25S	MP-4164-25S-C
		50.8 (1.99)	39.7 (1.56)	3.73 (0.14)	54.3 (2.14)	42 (1.65)	N/A	37	MP-4164-37S	MP-4164-37S-C
		57 (2.24)	44.5 (1.75)	4.39 (0.17)	60.8 (2.40)	45 (1.77)	N/A	54	MP-4164-54S	MP-4164-54S-C
		69.8 (2.74)	55.5 (2.18)	4.39 (0.17)	73.3 (2.88)	45 (1.77)	N/A	85	MP-4164-85S	MP-4164-85S-C
		69.8 (2.74)	55.5 (2.18)	4.39 (0.17)	73.3 (2.88)	45 (1.77)	N/A	150	MP-4164-150S	MP-4164-150S-C
		38 (1.49)	29.4 (1.15)	3.23 (0.13)	34.2 (1.34)	34.5 (1.35)	29 (1.14)	13	MP-4102-13P	MP-4102-13P-C
		41 (1.61)	31.8 (1.25)	3.23 (0.13)	37.4 (1.47)	34.5 (1.35)	32.2 (1.26)	19	MP-4102-19P	MP-4102-19P-C
		44.5 (1.75)	34.9 (1.37)	3.73 (0.14)	40.9 (1.61)	35.7 (1.40)	35.3 (1.38)	25	MP-4102-25P	MP-4102-25P-C
50.8 (1.99)	39.7 (1.56)	3.73 (0.14)	46.7 (1.83)	36.5 (1.44)	41.4 (1.62)	37	MP-4102-37P	MP-4102-37P-C		
57 (2.24)	44.5 (1.75)	4.30 (0.17)	53.4 (2.10)	38.5 (1.52)	47.8 (1.88)	54	MP-4102-54P	MP-4102-54P-C		
69.8 (2.74)	55.5 (2.18)	4.30 (0.17)	65.5 (2.57)	38.5 (1.52)	59 (2.32)	85	MP-4102-85P	MP-4102-85P-C		
69.8 (2.74)	55.5 (2.18)	4.30 (0.17)	65.5 (2.57)	38.5 (1.52)	59 (2.32)	150	MP-4102-150P	MP-4102-150P-C		
	<p>Plug protective dustcap to suit MP-4164 type.</p> 	34.16 (1.35)	31.5 (1.24)	110 (4.33)	4.7 (0.18)	-	-	13	MP-25042-13S	-
		37.36 (1.47)	31.5 (1.24)	110 (4.33)	4.7 (0.18)	-	-	19	MP-25042-19S	-
		40.87 (1.61)	31.5 (1.24)	110 (4.33)	4.7 (0.18)	-	-	25	MP-25042-25S	-
		46.68 (1.84)	31.5 (1.24)	110 (4.33)	4.7 (0.18)	-	-	37	MP-25042-37S	-
		53.36 (2.10)	31.5 (1.24)	110 (4.33)	5.5 (0.22)	-	-	54	MP-25042-54S	-
		65.48 (2.58)	31.5 (1.24)	110 (4.33)	5.5 (0.22)	-	-	85	MP-25042-85S	-
		65.48 (2.58)	31.5 (1.24)	110 (4.33)	5.5 (0.22)	-	-	150	MP-25042-150S	-
		38.8 (1.53)	20.7 (0.81)	255 (8.07)	-	-	-	13	MP-25042-13L	-
41.6 (1.64)	20.7 (0.81)	255 (8.07)	-	-	-	19	MP-25042-19L	-		
45.3 (1.78)	20.7 (0.81)	255 (8.07)	-	-	-	25	MP-25042-25L	-		
52.15 (2.05)	20.7 (0.81)	255 (8.07)	-	-	-	37	MP-25042-37L	-		
58.6 (2.30)	20.7 (0.81)	255 (8.07)	-	-	-	54	MP-25042-54L	-		
70.7 (2.78)	20.7 (0.81)	255 (8.07)	-	-	-	85	MP-25042-85L	-		
70.7 (2.78)	20.7 (0.81)	255 (8.07)	-	-	-	150	MP-25042-150L	-		

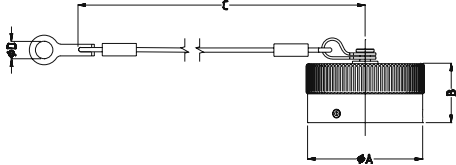

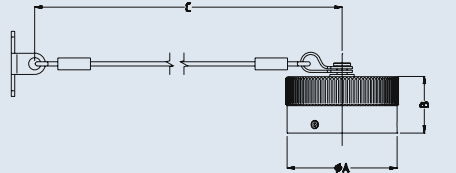
PRODUCT - FIGURE	Dimensions in mm (inches) DRAWING	Dimensions in mm (inches)						PINS	PART NUMBER
		A	B	C	D	E	F		
	Plug protective dustcap to suit MP-4102 types. 	34.16 (1.35)	31.5 (1.24)	110 (4.33)	4.7 (0.18)	-	-	13	MP-25043-13S
		37.36 (1.47)	31.5 (1.24)	110 (4.33)	4.7 (0.18)	-	-	19	MP-25043-19S
		40.87 (1.61)	31.5 (1.24)	110 (4.33)	4.7 (0.18)	-	-	25	MP-25043-25S
		46.68 (1.84)	31.5 (1.24)	110 (4.33)	4.7 (0.18)	-	-	37	MP-25043-37S
		53.36 (2.10)	31.5 (1.24)	110 (4.33)	5.5 (0.22)	-	-	54	MP-25043-54S
		65.48 (2.58)	31.5 (1.24)	110 (4.33)	5.5 (0.22)	-	-	85	MP-25043-85S
		65.48 (2.58)	31.5 (1.24)	110 (4.33)	5.5 (0.22)	-	-	150	MP-25043-150S
			Receptacle protective dustcap to suit MP-4101 types. 	38.8 (1.53)	20.7 (0.81)	255 (8.07)	-	-	-
41.6 (1.64)	20.7 (0.81)			255 (8.07)	-	-	-	19	MP-25043-19L
45.3 (1.78)	20.7 (0.81)			255 (8.07)	-	-	-	25	MP-25043-25L
52.15 (2.05)	20.7 (0.81)			255 (8.07)	-	-	-	37	MP-25043-37L
58.6 (2.30)	20.7 (0.81)			255 (8.07)	-	-	-	54	MP-25043-54L
70.7 (2.78)	20.7 (0.81)			255 (8.07)	-	-	-	85	MP-25043-85L
70.7 (2.78)	20.7 (0.81)			255 (8.07)	-	-	-	150	MP-25043-150L

PRODUCT - FIGURE	DRAWING	DESCRIPTION	NO. OF PINS	PART NUMBER
	N/A	Crimp Tool	All	M22520/1-01
	N/A	Positioner / Turret	All	TH29-1
	N/A	Insertion tool	13-85	MP-INS-16
			150	MP-INS-18
	N/A	Extraction tool	All	MP-EXT-16/18
	N/A	Contact Pilot Pin	13-85	MP-GUIDE-16
			150	MP-GUIDE-18
	N/A	Solder/Crimp Pin Contact	13-85 (Size 16)	MP-108400
		Crimp Pin Contact (Soldering of this contact is not recommended)	150 (Size 18)	MP-108300
	N/A	Solder/Crimp Socket Contact	13-85 (Size 16)	MP-108600
		Crimp Socket Contact (Soldering of this contact is not recommended)	150 (Size 18)	MP-108500

NOTE: Complete instructions for providing reliable crimped wire to contact terminations and inserting proprietary contacts in MP-41 Series connectors are available in publication PI523 located on our website www.amphenolaudio.com.

PART NUMBER BREAKDOWN MP-41 SERIES

MULTIPIN CIRCULAR CONNECTORS

E. G. **MP-4106-85S**
 Multipin, **4106** Cable Plug, **85** Contacts, **S** Female Socket Contacts,

SERIES PREFIX	MP	=	Series Prefix
HOUSING TYPE	4101	=	Inline cable connecting receptacle
	4102	=	Panel receptacle
	4106	=	Cable plug
	4164	=	Panel plug
	25042S	=	Dustcap for panel plug
	25042L	=	Dustcap for cable plug
	25043S	=	Dustcap for panel receptacle
	25043L	=	Dustcap for cable receptacle
NO. OF CONTACTS			13, 19, 25, 37, 54, 85, 150
GENDER *Not required for dustcap part numbers	P	=	Male pin contacts
	S	=	Female socket contacts
OPTIONS	C	=	Supplied with Dustcap

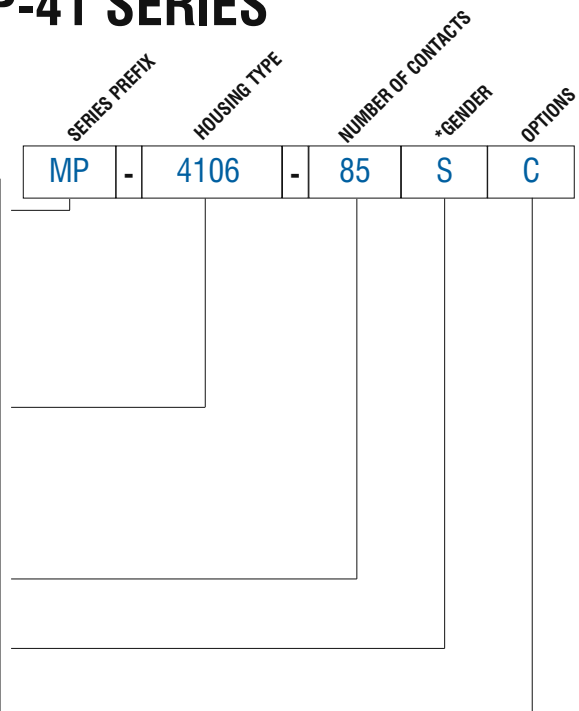

STANDARD DATA MP-41 SERIES

		VALUE						
GENERAL CHARACTERISTICS	Number of contacts	13	19	25	37	54	85	150
	Number of channels	4	6	8	12	16	28	48
	Termination	Solder / Crimp "Combo"						Crimp
	Wire Gauge - Stranded Wire	16AWG - 20AWG						18AWG
	Environmental	Complies with EU RoHS 2 Directive 2011/65/EU						
ELECTRICAL CHARACTERISTICS	Operating Voltage at Sea level - DC	250V*						250V*
	Operating Voltage at Sea level - AC	200V*						200V*
	Test Voltage AC RMS	1000V						1000V
	Current Carrying Capacity	13A						7.5A
	Typical Contact Resistance	3.46mΩ						11.25mΩ
	Insulation Resistance	5000MΩ						
CLIMATIC CHARACTERISTICS	Protection Class	IP67 (when mated)						
	Operating Temperature	-55°C to +125°C (-67°F to +257°F)						
MECHANICAL CHARACTERISTICS	Cable Retention	PG Gland						
	Mechanical Operations	2000 mating cycles						
MATERIALS	Connector / Shell Finish	Aluminium Alloy / Black						
	Insert	Synthetic Insert to MIL-R-3065						
	Male pin contact / Plating	Brass / Gold plated						
	Female socket contact / Plating	Brass / Gold plated						
CLAMPING CHARACTERISTICS	PG Gland	11	13.5	16	21	29	36	
	Cable Clamping range	mm	4-10	5-12	9-14	13-18	14-25	19-32
	(inches)	(0.15"-0.39")	(0.19"-0.47")	(0.35"-0.55")	(0.51"-0.70")	(0.55"-0.98")	(0.74"-1.25")	

Rev 2 - 03/2013

*Not suitable for domestic applications above 50V











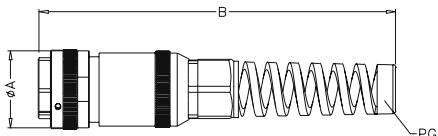

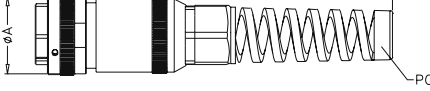

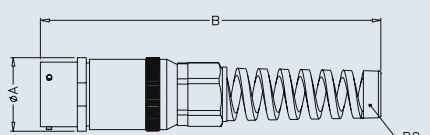

Amphenol's Multipin MP-62 series of circular connectors utilise the same design principles as the Mil-C-26482 military connectors. Featuring a three point quick mating bayonet coupling and five key polarisation ensuring a positive connection every time. Available in two contact pin layouts 39 and 61 with gold plated solder contacts fitted as standard.

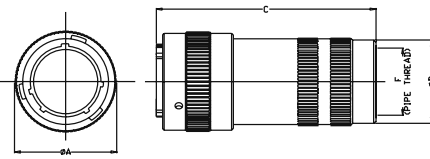

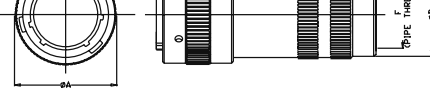

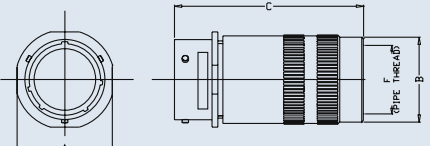

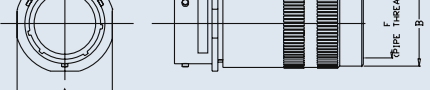
Features:



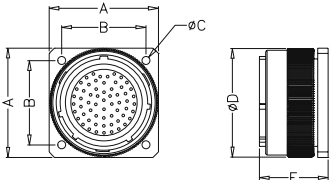

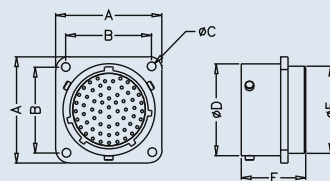

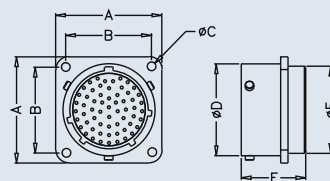

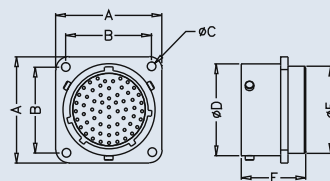

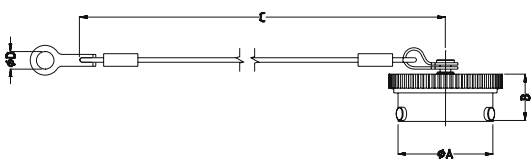

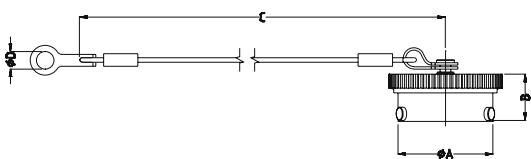

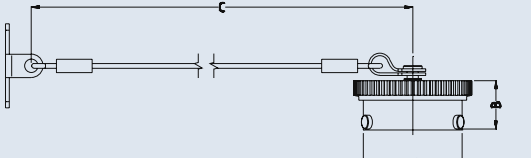
- 39 or 61 pins.
- Gold plated solder contacts.
- Neoprene insert.
- Protective dust caps
- Metal housings
- Environmental resistant.
- Black finish.
- Positive bayonet locking
- PG cable glands

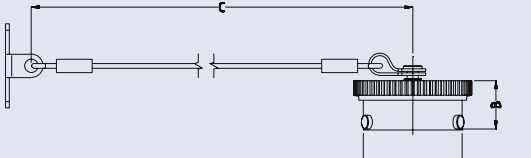
Specifications: page 135 Wiring Info: page 140

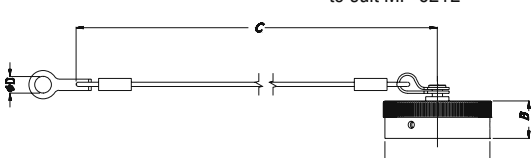
PRODUCT - FIGURE	Dimensions in mm (inches) DRAWING	Dimensions in mm (inches)			PINS	PART NUMBER	PART NUMBER With Dustcap
		A	B	PG			
	Straight cable plug with pin contacts, Black finish, Gold plated solder contacts. 	38.9	181.5	16	39		
		(1.53)	(7.15)			MP-6216-39P	MP-6216-39P-C
		45.5	193	21	61		
		(1.80)	(7.60)			MP-6216-61P	MP-6216-61P-C
	Cable connecting receptacle with socket contacts, Black finish, Gold plated solder contacts. 	36.7	181.5	16	39		
		(1.45)	(7.15)			MP-6211-39S	MP-6211-39S-C
		43.0	193	21	61		
		(1.70)	(7.60)			MP-6211-61S	MP-6211-61S-C
	Straight cable plug with pin contacts, NPT 3/4" threaded backshell, Black finish, Gold plated solder contacts. 	38.9	90	NPT	39		
		(1.53)	(3.54)	3/4"		MP-6516-39P	MP-6516-39P-C
		45.5	100	NPT	61		
		(1.80)	(3.94)	3/4"		MP-6516-61P	MP-6516-61P-C
	Cable connecting receptacle with socket contacts, NPT 3/4" threaded backshell, Black finish, Gold plated solder contacts. 	36.7	90	NPT	39		
		(1.45)	(3.54)	3/4"		MP-6511-39S	MP-6511-39S-C
		43.0	100	NPT	61		
		(1.70)	(3.94)	3/4"		MP-6511-61S	MP-6511-61S-C

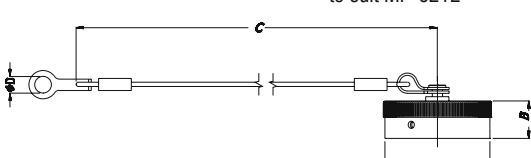

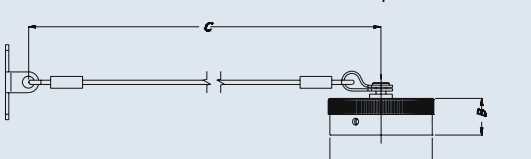
PRODUCT - FIGURE	Dimensions in mm (inches) DRAWING	Dimensions in mm (inches)						PINS	PART NUMBER	PART NUMBER With Dustcap
		A	B	C	D	E	F			
	Panel plug with pin contacts, Black finish, Gold plated solder contacts. 	38.86	29.36	6-32	39.0	32	-	39	MP-6256-39P	MP-6256-39P-C
		(1.53)	(1.16)	UNC	(1.54)	(1.26)	-			
	Panel receptacle plug with socket contacts, Black finish, Gold plated solder contacts. 	43.94	34.93	6-32	45.5	35	-	61	MP-6256-61P	MP-6256-61P-C
		(1.73)	(1.38)	UNC	(1.80)	(1.38)	-			
	Panel receptacle plug with socket contacts, Black finish, Gold plated solder contacts. 	36.7	29.36	3.05	31.8	22.3	30.1	39	MP-6212-39S	MP-6212-39S-C
		(1.44)	(1.15)	(0.12)	(1.25)	(0.87)	(1.18)			
	Panel receptacle plug with socket contacts, Black finish, Gold plated solder contacts. 	43.0	34.93	3.74	38.1	22.3	36.4	61	MP-6212-61S	MP-6212-61S-C
		(1.69)	(1.38)	(0.15)	(1.50)	(0.87)	(1.43)			

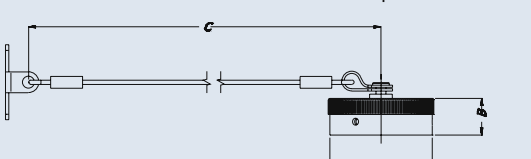
PRODUCT - FIGURE	DRAWING Dimensions in mm (inches)	DESCRIPTION	Dimensions in mm (inches)				PINS	PART NUMBER
			A	B	C	D		
		Plug protective dustcap to suit MP-6256	31.7	15.9	127	4.40	39	MP-742-39S
			(1.25)	(0.62)	(4.99)	(0.17)		
		Plug protective dustcap to suit MP-6256	38.05	16.70	127	4.40	61	MP-742-61S
			(1.50)	(0.66)	(4.99)	(0.17)		
		Receptacle protective dustcap to suit MP-6216	36.9	13.13	127	-	39	MP-742-39L
			(1.45)	(0.52)	(4.99)	-		
		Receptacle protective dustcap to suit MP-6216	43.14	14.15	127	-	61	MP-742-61L
			(1.70)	(0.56)	(4.99)	-		
		Plug protective dustcap to suit MP-6212	31.7	15.9	127	4.40	39	MP-738-39S
			(1.25)	(0.62)	(4.99)	(0.17)		
		Plug protective dustcap to suit MP-6212	38.05	16.70	127	4.40	61	MP-738-61S
			(1.50)	(0.66)	(4.99)	(0.17)		
		Receptacle protective dustcap to suit MP-6211	36.9	13.13	127	-	39	MP-738-39L
			(1.45)	(0.52)	(4.99)	-		
		Receptacle protective dustcap to suit MP-6211	43.14	14.15	127	-	61	MP-738-61L
			(1.70)	(0.56)	(4.99)	-		

STANDARD DATA MP-62 SERIES / MP - 65 SERIES

		VALUE	
GENERAL CHARACTERISTICS	Number of contacts	39	61
	Number of channels	12	20
	Termination	Solder	
	Wire Gauge - Stranded Wire	37 x 24AWG-20AWG 2 x 20AWG-16AWG	24AWG-20AWG
	Environmental	Complies with EU RoHS 2 Directive 2011/65/EU	
ELECTRICAL CHARACTERISTICS	Operating Voltage at Sea level - DC	600V*	
	Operating Voltage at Sea level - AC	600V*	
	Test Voltage AC RMS	1500V	
	Current Carrying Capacity	37 x 7.5A 2 x 13A	7.5A
	Insulation Resistance	5000MΩ	
CLIMATIC CHARACTERISTICS	Protection Class	IP67 (when mated)	
	Operating Temperature	-55°C to +125°C (-67°F to +257°F)	
MECHANICAL CHARACTERISTICS	Cable Retention	PG Gland / NPT Thread	
	Mechanical Operations	500 mating cycles (minimum)	
MATERIALS	Connector / Shell Finish	Aluminium Alloy / Black	
	Insert	Neoprene	
	Male pin contact machined - Plating	Brass / Gold plated	
	Female socket contact machined - Plating	Brass / Gold plated	
CLAMPING CHARACTERISTICS	PG Gland	16	21
	Cable Clamping range mm (inches)	9-14 (0.35"-0.55")	13-18 (0.51"-0.70")

Rev 3 - 03/2013

*Not suitable for domestic applications above 50V





146 SERIES RECTANGULAR CONNECTORS

Amphenol Tuchel C146 series rectangular connectors feature modular components ensuring a vast range of different features and benefits for the end user. The zinc diecast aluminum housings are finished in a durable powder coat and available in either top or side entry. Connector coupling is achieved via a positive locking lever ensuring a positive rapid connection. The C146 series is suitable for general-purpose audio and lighting applications and is completely intermateable with all competitor connectors.



FIBRE OPTIC

Amphenol has over 25 years experience in fibre optics dating back to their development of the first industry standard connector, the SMA. Today we can offer a complete range of products including Hybrid Fibre optic connectors for HDTV broadcast cameras SMPTE 304M compliant and ruggedised connectors and cable assemblies for indoor or outdoor applications.









ACCESSORIES

- Colour coded boots(backshells) and rings to assist in cable identification.
- In-line adaptors. Pre-wired for convenience.
- Termination tool for fast assembly of cable connectors.
- Mounting hardware.
- Metal boots(backshells) for rugged environments.

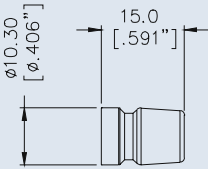

PRODUCT - FIGURE	DRAWING	DESCRIPTION	VARIATIONS	PART NUMBER
	<p>Dimensions in mm (inches)</p> <p>60.4 [2.378"]</p> <p>Ø19.0 [ø.748"]</p>	XLR 3 pole male to 3 pole male adapter, Pre wired, Metal Shell	Nickel Finish Black Finish	AC3M3MW AC3M3MBW
	<p>60.4 [2.378"]</p> <p>86.5 [3.406"]</p> <p>Ø19.0 [ø.748"]</p>	XLR 3 pole female to 3 pole female adapter, Pre wired, Metal Shell	Nickel Finish Black Finish	AC3F3FW AC3F3FBW
	<p>60.4 [2.378"]</p> <p>73.5 [2.892"]</p> <p>Ø19.0 [ø.748"]</p>	XLR 3 pole female to 3 pole male adapter, Pre wired, Metal Shell	Nickel Finish Black Finish	AC3F3MW AC3F3MBW
	<p>62.5 [2.461"]</p> <p>75.7 [2.980"]</p> <p>Ø18.9 [ø.744"]</p>	XLR 3 pole female to 5 pole male adapter, Pre wired, Metal Shell	Nickel Finish	AC3F5MW
	<p>62.5 [2.461"]</p> <p>75.7 [2.980"]</p> <p>Ø18.9 [ø.744"]</p>	XLR 3 pole male to 5 pole female adapter, Pre wired, Metal Shell	Nickel Finish	AC3M5FW
	<p>76 [2.991"]</p> <p>Ø19 [ø.748"]</p>	XLR 5 pole male to 5 pole male adapter, Pre wired, Metal Shell	Nickel Finish	AC5M5MW
	<p>702.3 [2.768"]</p> <p>100 [3.937"]</p> <p>212.0 [8.350"]</p> <p>22 [0.866"]</p> <p>74.9 [2.945"]</p> <p>2-Ø5.1 [ø.199"]</p> <p>1-Ø6.5 [ø.2559"]</p> <p>1-Ø6.5 [ø.2559"]</p>	Termination Tool	For IDC and Solder cable connectors	T2860
	<p>2-Ø5.8 THRU [ø.231"]</p> <p>1-Ø6.8 [ø.268"]</p> <p>44 [1.732"]</p> <p>49.8 [1.957"]</p> <p>70.0 [2.756"]</p> <p>10 [0.394"]</p> <p>215 [8.465"]</p> <p>Ø17</p> <p>END OF STROKE</p>	Termination Tool	For AC Series Right Angle cable connectors	T2880
	<p>2-Ø5.8 THRU [ø.231"]</p> <p>1-Ø6.8 [ø.268"]</p> <p>44 [1.732"]</p> <p>49.8 [1.957"]</p> <p>70.0 [2.756"]</p> <p>10 [0.394"]</p> <p>215 [8.465"]</p> <p>Ø17</p> <p>END OF STROKE</p>	Termination Tool	For AX Series cable connectors	T2890
	<p>2.0 [0.080"]</p> <p>7.8 [0.307"]</p> <p>Ø3.3 [ø.130"]</p> <p>ISO VIEW Ø3.0x0.5</p> <p>SELF-TAPPING SCREW WITH THREAD 2.8x1.04 AND TRI-RONDULAR CONFIGURATION</p>	A Type / C Type Connector Mounting, Self-Tapping Screw	2.9 x 1.06 Tri-rondular	52500002-734
	<p>M2.5 x 0.45</p> <p>Ø4.50</p> <p>17</p> <p>8.0</p>	B Type Connector Mounting, Self-Tapping Screw	M2.5	52500005-732

ACC.

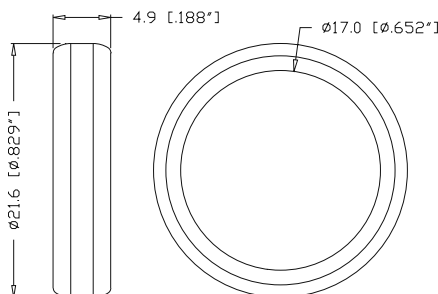
137

PRODUCT - FIGURE	DRAWING Dimensions in mm (inches)	DESCRIPTION	VARIATIONS	PART NUMBER
		AX Series Coloured Boot	Brown	AX-BOOT-1
			Red	AX-BOOT-2
			Orange	AX-BOOT-3
			Yellow	AX-BOOT-4
			Green	AX-BOOT-5
			Blue	AX-BOOT-6
			Violet	AX-BOOT-7
			Grey	AX-BOOT-8
			White	AX-BOOT-9
			Black	AX-BOOT
Clear	AX-BOOT-CLR			
		AC Coloured Boot / Backshell Note: Number Identification optional. (Please contact us.)	Brown	AC-NUT-BRN
			Red	AC-NUT-RED
			Orange	AC-NUT-ORG
			Yellow	AC-NUT-YEL
			Green	AC-NUT-GRN
			Blue	AC-NUT-BLU
			Violet	AC-NUT-VIO
			Grey	AC-NUT-GRY
White	AC-NUT-WHT			
		Description: Coloured Grommets to suit AC Series, T Series and Musician range	Brown	AC-GROMMET-BRN
			Red	AC-GROMMET-RED
			Orange	AC-GROMMET-ORG
			Yellow	AC-GROMMET-YEL
			Green	AC-GROMMET-GRN
			Blue	AC-GROMMET-BLU
			Violet	AC-GROMMET-VIO
			Grey	AC-GROMMET-GRY
White	AC-GROMMET-WHT			
		AC Coloured Identification Rings – Plain and Numbered Note: Custom number Identification optional. (Please contact us.)	Brown	AC-RING-BRN
			Red	AC-RING-RED
			Orange	AC-RING-ORG
			Yellow	AC-RING-YEL
			Green	AC-RING-GRN
			Blue	AC-RING-BLU
			Violet	AC-RING-VIO
			Grey	AC-RING-GRY
			White	AC-RING-WHT
			Red #1-24	AC-RING-RED-PK1
			Yellow #1-24	AC-RING-YEL-PK1
			Blue #1-24	AC-RING-BLU-PK1
			Red #1-48	AC-RING-RED-PK2
			Yellow #1-48	AC-RING-YEL-PK2
Blue #1-48	AC-RING-BLU-PK2			

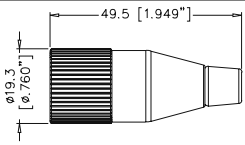
ACC.

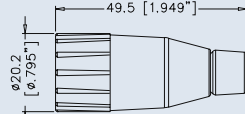
PRODUCT - FIGURE	DRAWING	DESCRIPTION	VARIATIONS	PART NUMBER
	<p style="text-align: center;">Dimensions in mm (inches)</p> 	AC Metal Boot / Backshell, Black Finish	Not Applicable	AC-NUT-METAL
		AC Thermoplastic Boot / Backshell. Suitable for use with 8.5mm (0.33") O.D. cable.	Not Applicable	AC-NUT-J-BLK

ACC.

NOTE: All accessories comply with EU RoHS 2 Directive 2011/65/EU
 NOTE: Please do not refer to this printed catalogue as a colour reference. For exact colours contact your sales representative.

CONNECTOR WIRING INFORMATION

XLR (Microphone / Patch Cables)

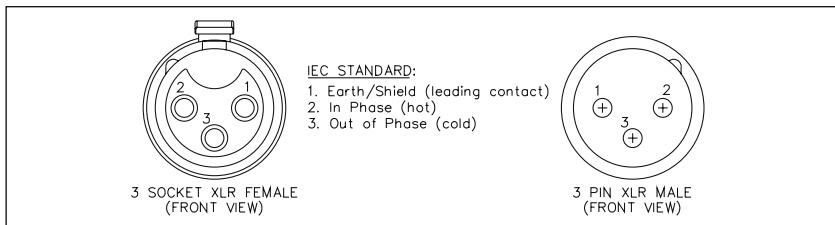

The standard XLR 3 contact pin outs are as shown above for a balanced lead. In such a configuration audio "Hot" (pin 2) is the in-phase connection whilst audio "Cold" (pin 3) is the out-of-phase connection. For an unbalanced lead however, you may connect pin 1 to either pin 2 or pin 3, but not both. In such a configuration the remaining pin is used for the audio signal.

When terminating the cable shielding to pin 1 it is suggested that the shield be only grounded at one end of the cable to avoid inducing "hum". Pin 1 is a leading contact that engages at interconnection, before pin 2 or pin 3.

PDN (Speaker Cables)

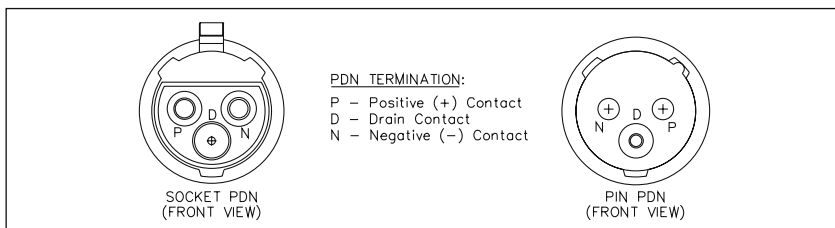

The PDN stands for Positive, Drain and Negative. P pin is used for the Positive (+) line and the N pin is for the return line. D pin is a leading contact that engages at interconnection, before the major contacts. If applicable, solder the cable screen to this contact.

1/4" Phono (6.35mm) (Standard Applications)

MICROPHONE CABLE - BALANCED

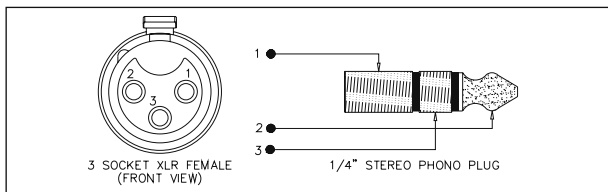

MICROPHONE CABLE - UNBALANCED

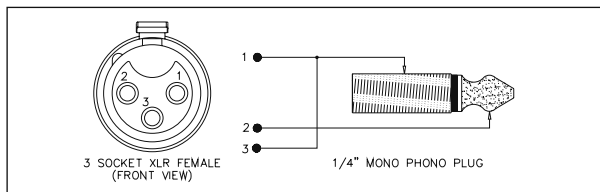

INSTRUMENT / LINE CABLE (MONO)

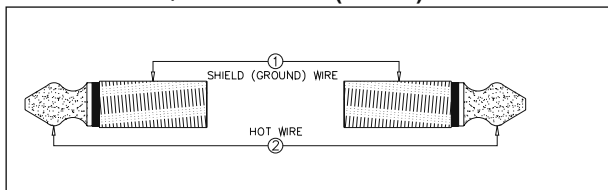

INSTRUMENT / LINE CABLE (STEREO)

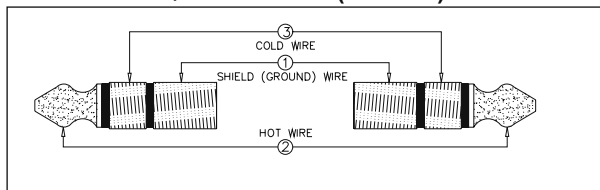

Amphenol

CONNECTOR WIRING INFORMATION

MP Series

MP-41 Series
4 Ch -13 pin

Ch	+	-	G
1	B	C	E
2	F	K	H
3	J	D	A
4	N	M	G
General			
Ground	L		

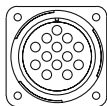

MP-41 Series
6 Ch - 19 pin

Ch	+	-	G
1	L	M	U
2	A	N	B
3	K	J	T
4	V	P	C
5	H	S	G
6	R	D	E
General			
Ground	F		

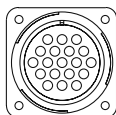

MP-41 Series
8 Ch -25 pin

Ch	+	-	G
1	A	E	F
2	G	C	B
3	D	H	J
4	M	L	K
5	Q	P	N
6	W	S	R
7	T	X	Y
8	Z	V	U
General			
Ground	a		

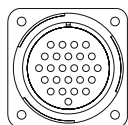

MP-41 Series
12 Ch-37 pin

Ch	+	-	G
1	E	F	A
2	B	C	G
3	H	J	D
4	S	T	K
5	L	M	U
6	V	W	N
7	P	R	X
8	a	b	g
9	c	d	j
10	e	f	m
11	n	p	h
12	r	s	k
General			
Ground	z		

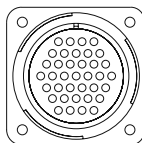

MP-41 Series
16 Ch-54 pin

Ch	+	-	G
1	W	f	r
2	J	R	a
3	k	v	AC
4	E	M	V
5	e	q	y
6	B	H	P
7	Z	j	u
8	D	L	U
9	d	p	x
10	A	G	O
11	Y	h	t
12	C	K	T
13	c	n	w
14	F	N	X
15	g	s	AB
16	S	b	m
General			
Ground	AG		

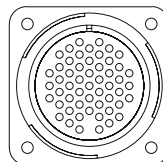

MP-41 Series
28 Ch-85 pin

Ch	+	-	G
1	A	B	C
2	E	F	H
3	J	K	L
4	N	P	R
5	S	T	U
6	X	Y	Z
7	a	b	c
8	d	f	g
9	h	i	j
10	k	m	n
11	p	q	r
12	t	u	v
13	w	x	y
14	z	AA	AB
15	AC	AD	AE
16	AF	AH	AJ
17	AK	AL	AM
18	AP	AR	AS
19	AT	AU	AV
20	AW	AX	AY
21	AZ	BA	BB
22	BC	BD	BE
23	BJ	BK	BL
24	BM	BN	BP
25	BS	BT	BU
26	BV	BR	BF
27	BH	AN	s
28	W	M	D
General			
Ground	V		

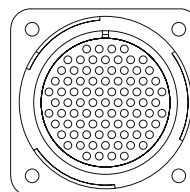

MP-41 Series
48 Ch - 150 pin

Ch	+	-	G
1	1	2	3
2	5	6	7
3	8	9	10
4	11	12	13
5	14	15	16
6	17	18	19
7	21	22	23
8	24	25	26
9	27	28	29
10	20	30	31
11	32	33	34
12	35	36	37
13	38	39	40
14	41	42	43
15	44	45	46
16	47	48	49
17	50	51	52
18	53	54	55
19	57	58	59
20	60	61	62
21	63	64	65
22	66	67	68
23	69	70	71
24	72	73	74
25	75	76	77
26	78	79	80
27	82	83	84
28	85	86	87
29	88	89	90
30	91	92	93
31	94	95	96
32	97	98	99
33	100	101	102
34	103	104	105
35	56	81	106
36	107	108	109
37	110	111	112
38	113	114	115
39	116	117	118
40	119	120	121
41	122	123	124
42	125	126	127
43	139	128	129
44	130	131	132
45	133	134	135
46	136	137	138
47	140	141	142
48	143	144	145
General			
Ground	150		

MP-62 Series
12 Ch-39 pin

Ch	+	-	G
1	p	n	q
2	W	A	X
3	N	f	P
4	L	e	M
5	J	d	K
6	G	c	H
7	E	b	F
8	D	a	Z
9	C	B	Y
10	U	j	V
11	i	h	T
12	R	g	S
General			
Ground	N/A		

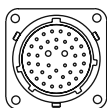

MP-62 Series
20 Ch-61 pin

Ch	+	-	G
1	JJ	HH	NN
2	MM	KK	PP
3	BB	AA	CC
4	s	FF	W
5	r	EE	V
6	e	D	x
7	f	E	y
8	q	DD	U
9	S	p	T
10	P	N	R
11	m	k	n
12	L	K	M
13	J	i	j
14	H	G	h
15	g	F	z
16	d	C	w
17	B	A	c
18	b	a	Z
19	v	u	Y
20	t	GG	X
General			
Ground	N/A		

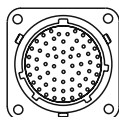

Part Number	Page	Part Number	Page	Part Number	Page	Part Number	Page	Part Number	Page
Symbols		AC3FBVB1-AU-B	41	AC3MAV1-AU-B	36	AC3MMCP BULK	14	AC4FR	15
47-10070	91	AC3FBVB2-AU-B	41	AC3MAV2-AU-B	36	AC3MMCPJ	14	AC4M	11
47-10090	91	AC3FBVB3-AU-B	41	AC3MAV3-AU-B	36	AC3MMDP	60	AC4M-AU	11
47-10110	91	AC3FBVBL1-AU-B	42	AC3MAV4-AU-B	36	AC3MMDP BULK	60	AC4MB	11
47-10120	91	AC3FBVBL2-AU-B	42	AC3MAV-AU-B	36	AC3MMDPL	60	AC4MB-AU	11
47-10150	91	AC3FBVBL3-AU-B	42	AC3MB	10	AC3MMDPL BULK	60	AC4MB BULK	11
112119	90	AC3FBVBL1-AU-B	41	AC3MB-AU	10	AC3MMDZ	23	AC4MBJ	11
112133	90	AC3FBVBL2-AU-B	41	AC3MB BULK	10	AC3MMDZ-AU	23	AC4M BULK	11
112507	90	AC3FBVL1-AU-B	42	AC3MBH1-AU-B	39	AC3MMDZB	23	AC4MDZ	24
112508	90	AC3FBVL2-AU-B	42	AC3MBH2-AU-B	39	AC3MMDZB-AU	23	AC4MDZ-AU	24
112509	90	AC3FBVL3-AU-B	42	AC3MBH3-AU-B	39	AC3MMDZB BULK	23	AC4MDZB	24
112519	90	AC3FBVL-AU-B	41	AC3MBH-AU-B	39	AC3MMDZB BULK	23	AC4MDZB-AU	24
112521	90	AC3FCP	14	AC3MBHB1-AU-B	39	AC3MMDZV	23	AC4MDZB BULK	24
112565	90	AC3FCP-AU	14	AC3MBHB2-AU-B	39	AC3MMDZVB	23	AC4MDZV	24
112606	90	AC3FCP BULK	14	AC3MBHB3-AU-B	39	AC3MMJ	10	AC4MDZVB	24
112950	90	AC3FCPI	18	AC3MBHB-AU-B	39	AC3MMP	26	AC4MJ	11
112951	90	AC3FCPI-AU	18	AC3MBHBL-AU-B	39	AC3MMP-AU	26	AC4MP	27
112952	90	AC3FCPI BULK	18	AC3MBHL-AU-B	39	AC3MMPB	26	AC4MP-AU	27
112953	90	AC3FCPJ	14	AC3MBJ	10	AC3MMPB-AU	26	AC4MPB	27
112955	90	AC3FDP	60	AC3M BULK	10	AC3MMPB BULK	26	AC4MPB-AU	27
112956	90	AC3FDP BULK	60	AC3MBV1-AU-B	40	AC3MMP BULK	26	AC4MPB BULK	27
112957	90	AC3FDPH	60	AC3MBV2-AU-B	40	AC3MMPN	26	AC4MP BULK	27
52500002-734	137	AC3FDPH BULK	60	AC3MBV3-AU-B	40	AC3MMPN-AU	26	AC4MPN	27
52500005-732	137	AC3FDPHL	60	AC3MBV-AU-B	39	AC3MMPN BULK	26	AC4MPN-AU	27
		AC3FDPHL BULK	60	AC3MBVB1-AU-B	40	AC3MMPN BULK	26	AC4MPN BULK	27
		AC3FDPI	62	AC3MBVB2-AU-B	40	AC3MMPN BULK	26	AC4MPN-AU	27
A		AC3FDPI BULK	62	AC3MBVB3-AU-B	40	AC3MMPN BULK	26	AC4MPN BULK	27
AC3F	10	AC3FDPI BULK	62	AC3MBVB-AU-B	39	AC3MMPN BULK	26	AC4MPN BULK	27
AC3F3FBW	137	AC3FDPL	60	AC3MCP	14	AC3MMPN BULK	26	AC4MPN BULK	27
AC3F3FW	137	AC3FDPL BULK	60	AC3MCP-AU	14	AC3MMPN BULK	26	AC4MPN BULK	27
AC3F3MBW	137	AC3FDPL BULK	60	AC3MCP BULK	14	AC3MMPN BULK	26	AC4MPN BULK	27
AC3F3MW	137	AC3FDPV	60	AC3MCP BULK	14	AC3MMPN BULK	26	AC4MPN BULK	27
AC3F5MW	137	AC3FDPV BULK	60	AC3MCP BULK	14	AC3MMPN BULK	26	AC4MPN BULK	27
AC3FAH1-AU-B	36	AC3FDPV BULK	60	AC3MCP BULK	14	AC3MMPN BULK	26	AC4MPN BULK	27
AC3FAH2-AU-B	37	AC3FDPV BULK	60	AC3MCP BULK	14	AC3MMPN BULK	26	AC4MPN BULK	27
AC3FAH3-AU-B	37	AC3FDPV BULK	60	AC3MCP BULK	14	AC3MMPN BULK	26	AC4MPN BULK	27
AC3FAH-AU-B	36	AC3FDPV BULK	60	AC3MCP BULK	14	AC3MMPN BULK	26	AC4MPN BULK	27
AC3FAHL1-AU-B	37	AC3FDPV BULK	60	AC3MCP BULK	14	AC3MMPN BULK	26	AC4MPN BULK	27
AC3FAHL2-AU-B	37	AC3FDPV BULK	60	AC3MCP BULK	14	AC3MMPN BULK	26	AC4MPN BULK	27
AC3FAHL3-AU-B	37	AC3FDPV BULK	60	AC3MCP BULK	14	AC3MMPN BULK	26	AC4MPN BULK	27
AC3FAHL-AU-B	37	AC3FDPV BULK	60	AC3MCP BULK	14	AC3MMPN BULK	26	AC4MPN BULK	27
AC3F-AU	10	AC3FDPV BULK	60	AC3MCP BULK	14	AC3MMPN BULK	26	AC4MPN BULK	27
AC3FAV1-AU-B	37	AC3FDPV BULK	60	AC3MCP BULK	14	AC3MMPN BULK	26	AC4MPN BULK	27
AC3FAV2-AU-B	38	AC3FDPV BULK	60	AC3MCP BULK	14	AC3MMPN BULK	26	AC4MPN BULK	27
AC3FAV3-AU-B	38	AC3FDPV BULK	60	AC3MCP BULK	14	AC3MMPN BULK	26	AC4MPN BULK	27
AC3FAV-AU-B	37	AC3FDPV BULK	60	AC3MCP BULK	14	AC3MMPN BULK	26	AC4MPN BULK	27
AC3FAVL1-AU-B	38	AC3FDPV BULK	60	AC3MCP BULK	14	AC3MMPN BULK	26	AC4MPN BULK	27
AC3FAVL2-AU-B	38	AC3FDPV BULK	60	AC3MCP BULK	14	AC3MMPN BULK	26	AC4MPN BULK	27
AC3FAVL3-AU-B	38	AC3FDPV BULK	60	AC3MCP BULK	14	AC3MMPN BULK	26	AC4MPN BULK	27
AC3FAVL-AU-B	38	AC3FDPV BULK	60	AC3MCP BULK	14	AC3MMPN BULK	26	AC4MPN BULK	27
AC3FB	10	AC3FDPV BULK	60	AC3MCP BULK	14	AC3MMPN BULK	26	AC4MPN BULK	27
AC3FB-AU	10	AC3FDPV BULK	60	AC3MCP BULK	14	AC3MMPN BULK	26	AC4MPN BULK	27
AC3FB BULK	10	AC3FDPV BULK	60	AC3MCP BULK	14	AC3MMPN BULK	26	AC4MPN BULK	27
AC3FBH1-AU-B	40	AC3FDPV BULK	60	AC3MCP BULK	14	AC3MMPN BULK	26	AC4MPN BULK	27
AC3FBH2-AU-B	40	AC3FDPV BULK	60	AC3MCP BULK	14	AC3MMPN BULK	26	AC4MPN BULK	27
AC3FBH3-AU-B	40	AC3FDPV BULK	60	AC3MCP BULK	14	AC3MMPN BULK	26	AC4MPN BULK	27
AC3FBH-AU-B	40	AC3FDPV BULK	60	AC3MCP BULK	14	AC3MMPN BULK	26	AC4MPN BULK	27
AC3FBHB1-AU-B	40	AC3FDPV BULK	60	AC3MCP BULK	14	AC3MMPN BULK	26	AC4MPN BULK	27
AC3FBHB2-AU-B	40	AC3FDPV BULK	60	AC3MCP BULK	14	AC3MMPN BULK	26	AC4MPN BULK	27
AC3FBHB3-AU-B	40	AC3FDPV BULK	60	AC3MCP BULK	14	AC3MMPN BULK	26	AC4MPN BULK	27
AC3FBHB-AU-B	40	AC3FDPV BULK	60	AC3MCP BULK	14	AC3MMPN BULK	26	AC4MPN BULK	27
AC3FBHBL1-AU-B	41	AC3FDPV BULK	60	AC3MCP BULK	14	AC3MMPN BULK	26	AC4MPN BULK	27
AC3FBHBL2-AU-B	41	AC3FDPV BULK	60	AC3MCP BULK	14	AC3MMPN BULK	26	AC4MPN BULK	27
AC3FBHBL3-AU-B	41	AC3FDPV BULK	60	AC3MCP BULK	14	AC3MMPN BULK	26	AC4MPN BULK	27
AC3FBHBL-AU-B	40	AC3FDPV BULK	60	AC3MCP BULK	14	AC3MMPN BULK	26	AC4MPN BULK	27
AC3FBHL1-AU-B	41	AC3FDPV BULK	60	AC3MCP BULK	14	AC3MMPN BULK	26	AC4MPN BULK	27
AC3FBHL2-AU-B	41	AC3FDPV BULK	60	AC3MCP BULK	14	AC3MMPN BULK	26	AC4MPN BULK	27
AC3FBHL3-AU-B	41	AC3FDPV BULK	60	AC3MCP BULK	14	AC3MMPN BULK	26	AC4MPN BULK	27
AC3FBHL-AU-B	40	AC3FDPV BULK	60	AC3MCP BULK	14	AC3MMPN BULK	26	AC4MPN BULK	27
AC3FBJ	10	AC3FDPV BULK	60	AC3MCP BULK	14	AC3MMPN BULK	26	AC4MPN BULK	27
AC3F BULK	10	AC3FDPV BULK	60	AC3MCP BULK	14	AC3MMPN BULK	26	AC4MPN BULK	27
AC3FBV1-AU-B	41	AC3FDPV BULK	60	AC3MCP BULK	14	AC3MMPN BULK	26	AC4MPN BULK	27
AC3FBV2-AU-B	41	AC3FDPV BULK	60	AC3MCP BULK	14	AC3MMPN BULK	26	AC4MPN BULK	27
AC3FBV3-AU-B	41	AC3FDPV BULK	60	AC3MCP BULK	14	AC3MMPN BULK	26	AC4MPN BULK	27
AC3FBV-AU-B	41	AC3FDPV BULK	60	AC3MCP BULK	14	AC3MMPN BULK	26	AC4MPN BULK	27

Amphenol

INDEX

Part Number	Page	Part Number	Page	Part Number	Page	Part Number	Page	Part Number	Page
AC5MDZ BULK	24	AC6AMPNZVB	29	AC-GROMMET-BLU	138	ACJM-MN-2	113	ACJS-NV35-5	110
AC5MDZV	24	AC6AMPV	29	AC-GROMMET-BRN	138	ACJM-MN-2S	113	ACJS-PC	112
AC5MDZVB	24	AC6AMPVB	29	AC-GROMMET-GRN	138	ACJM-MV-2	113	ACJS - PH	112
AC5MJ	11	AC6AMR	15	AC-GROMMET-GRY	138	ACJM-MV-2S	113	ACJS-PHOP	111
AC5MP	28	AC7F	12	AC-GROMMET-ORG	138	ACJM-MV35-2	110	ACJS-PHOP-1	111
AC5MP-AU	28	AC7FB	12	AC-GROMMET-RED	138	ACJM-MV35-2S	110	ACJS-PHR	112
AC5MPB	28	AC7FB BULK	12	AC-GROMMET-VIO	138	ACJM-MVD985-2	110	ACJS-PHS	112
AC5MPB-AU	28	AC7FBJ	12	AC-GROMMET-WHT	138	ACJM-MVD985-2S	110	ACJS-PVB-3	113
AC5MPB BULK	28	AC7F BULK	12	AC-GROMMET-YEL	138	ACJM-MVS-2	114	ACJS-PVB-3S	113
AC5MP BULK	28	AC7FDZ	25	ACJC5H BULK	53	ACJM-MVS-2S	114	ACJS-PVB-5	113
AC5MPNZ	28	AC7FDZB	25	ACJC5HL BULK	53	ACJM-NH35	110	AC-NUT-BLU	138
AC5MPNZ-AU	28	AC7FDZB BULK	25	ACJC5S BULK	53	ACJM-NV35-2	110	AC-NUT-BRN	138
AC5MPNZB	28	AC7FDZ BULK	25	ACJC5SL BULK	53	ACJM-NV35-2S	110	AC-NUT-GRN	138
AC5MPNZB-AU	28	AC7FDZV	25	ACJC5V BULK	53	ACJM-PC	112	AC-NUT-GRY	138
AC5MPNZB BULK	28	AC7FDZVB	25	ACJC5VL BULK	53	ACJM - PH	111	AC-NUT-J-BLK	139
AC5MPNZ BULK	28	AC7FJ	12	ACJC6AH BULK	51	ACJM-PHOP	111	AC-NUT-METAL	139
AC5MPNZV	28	AC7FPZ	30	ACJC6AHL BULK	51	ACJM-PHOP-1	111	AC-NUT-ORG	138
AC5MPNZVB	28	AC7FPZB	30	ACJC6AV BULK	51	ACJM-PHR	112	AC-NUT-RED	138
AC5MPV	28	AC7FPZB BULK	30	ACJC6AVL BULK	51	ACJM-PHS	112	AC-NUT-VIO	138
AC5MPVB	28	AC7FPZ BULK	30	ACJC6H BULK	54	ACJM-PVB-2	113	AC-NUT-WHT	138
AC5MR	15	AC7FPZV	30	ACJC6HL BULK	54	ACJM-PVB-2S	113	AC-NUT-YEL	138
AC6AF	12	AC7FPZVB	30	ACJC6S BULK	54	ACJR-BLK	121	ACPL-CBK	121
AC6AF-AU	12	AC7FR	15	ACJC6SL BULK	54	ACJR-BLU	121	ACPL-CBL	121
AC6AFB	12	AC7M	12	ACJC6V BULK	54	ACJR-GRN	121	ACPL-CGR	121
AC6AFB-AU	12	AC7MB	12	ACJC6VL BULK	54	ACJR-RED	121	ACPL-CRD	121
AC6AFB BULK	12	AC7MB BULK	12	ACJC9AH BULK	51	ACJR-SBK	121	ACPL-CWH	121
AC6AFBJ	12	AC7MBJ	12	ACJC9AHL BULK	51	ACJR-SBL	121	ACPL-CYL	121
AC6AF BULK	12	AC7M BULK	12	ACJC9AV BULK	52	ACJR-SGR	121	ACPM-GB	106
AC6AFDZ	25	AC7MDZ	25	ACJC9AVL BULK	52	ACJR-SRD	121	ACPM-GB-AU	106
AC6AFDZ-AU	25	AC7MDZB	25	ACJC9H BULK	54	ACJR-SWH	121	ACPM-GB BULK	106
AC6AFDZB	25	AC7MDZB BULK	25	ACJC9HL BULK	54	ACJR-SYL	121	ACPM-GN	106
AC6AFDZB-AU	25	AC7MDZ BULK	25	ACJC9M BULK	56	ACJR-WHT	121	ACPM-GN-AU	106
AC6AFDZB BULK	25	AC7MDZV	25	ACJC9S BULK	55	ACJR-YEL	121	ACPM-GN BULK	106
AC6AFDZ BULK	25	AC7MDZVB	25	ACJC9SL BULK	55	ACJS-HHDR	110	ACPM-KB	104
AC6AFDZV	25	AC7MJ	12	ACJC9V BULK	55	ACJS-HHOP	111	ACPM-KB-AU	104
AC6AFDZVB	25	AC7MP	30	ACJC9VL BULK	55	ACJS-HHOP-1	111	ACPM-KB BULK	104
AC6AFJ	12	AC7MPB	30	ACJC10AH BULK	52	ACJS-IH	112	ACPM-KN	104
AC6AFPZ	29	AC7MPB BULK	30	ACJC10AHL BULK	52	ACJS-IHS	112	ACPM-KN-AU	104
AC6AFPZ-AU	29	AC7MP BULK	30	ACJC10AV BULK	52	ACJS-MC	112	ACPM-KN-BULK	104
AC6AFPZB	29	AC7MPNZ	29	ACJC10AVL BULK	52	ACJS - MH	112	ACPM-RB	107
AC6AFPZB-AU	29	AC7MPNZB	29	ACJC10H BULK	55	ACJS-MHD	113	ACPM-RB-AU	107
AC6AFPZB BULK	29	AC7MPNZB BULK	29	ACJC10HL BULK	55	ACJS-MHD985	110	ACPM-RB BULK	107
AC6AFPZ BULK	29	AC7MPNZ BULK	29	ACJC10S BULK	56	ACJS-MHDC*	112	ACPM-RN	107
AC6AFPZV	29	AC7MPNZV	29	ACJC10SL BULK	56	ACJS-MHDCM	112	ACPM-RN-AU	107
AC6AFPZVB	29	AC7MPNZVB	29	ACJC10V BULK	55	ACJS-MHDE	113	ACPM-RN BULK	107
AC6AFR	15	AC7MPV	30	ACJC10VL BULK	55	ACJS-MHDEM	113	ACPM-TB	105
AC6AM	12	AC7MPVB	30	ACJD-BLK	122	ACJS-MHDM	113	ACPM-TB-AU	105
AC6AM-AU	12	AC7MR	15	ACJD-BLU	122	ACJS-MHDR	111	ACPM-TB BULK	105
AC6AMB	12	AC-BNC20A	92	ACJD-GRN	122	ACJS-MHDRM	111	ACPM-TN	105
AC6AMB-AU	12	AC-BNC20AJ75	92	ACJD-RED	122	ACJS-MHOM	111	ACPM-TN-AU	105
AC6AMB BULK	12	AC-BNC20AP75	92	ACJD-WHT	122	ACJS-MHOP	111	ACPM-TN BULK	105
AC6AMBJ	12	AC-BNC20B	92	ACJD-YEL	122	ACJS-MHOP-1	111	ACPR-BLK	121
AC6AM BULK	12	AC-BNC20BJ75	92	ACJM-HHDR	110	ACJS-MHR	112	ACPR-BLU	121
AC6AMDZ	25	AC-BNC20BP75	92	ACJM-HHOP	111	ACJS-MHS	112	ACPR-GRN	121
AC6AMDZ-AU	25	AC-BNC20M	92	ACJM-HHOP-1	111	ACJS-MIV-3	113	ACPR-RED	121
AC6AMDZB	25	AC-BNC20MJ75	92	ACJM-IH	112	ACJS-MIV-3S	113	ACPR-SBK	121
AC6AMDZB-AU	25	AC-BNC20MP75	92	ACJM-IHS	112	ACJS-MIV-5	113	ACPR-SBL	121
AC6AMDZB BULK	25	AC-BNC40A	92	ACJM-MC	112	ACJS-MN-3	113	ACPR-SGR	121
AC6AMDZ BULK	25	AC-BNC40AJ75	92	ACJM-MH	111	ACJS-MN-3S	113	ACPR-SRD	121
AC6AMDZV	25	AC-BNC40AP75	92	ACJM-MHD	113	ACJS-MN-5	113	ACPR-SWH	121
AC6AMDZVB	25	AC-BNC40B	92	ACJM-MHD985	110	ACJS-MV-3	113	ACPR-SYL	121
AC6AMJ	12	AC-BNC40BJ75	92	ACJM-MHDC*	112	ACJS-MV-3S	113	ACPR-WHT	121
AC6AMP	29	AC-BNC40BP75	92	ACJM-MHDCM	112	ACJS-MV-5	113	ACPR-YEL	121
AC6AMP-AU	29	AC-BNC40M	92	ACJM-MHDE	113	ACJS-MV35-3	110	ACPS-GB	106
AC6AMPB	29	AC-BNC40MJ75	92	ACJM-MHDEM	113	ACJS-MV35-3S	110	ACPS-GB-AU	106
AC6AMPB-AU	29	AC-BNC40MP75	92	ACJM-MHDM	113	ACJS-MV35-5	110	ACPS-GB BULK	106
AC6AMPB BULK	29	AC-BNC-JJ-75	91	ACJM-MHDR	111	ACJS-MVD985-3	110	ACPS-GN	106
AC6AMP BULK	29	AC-BNC-JJ-75B	91	ACJM-MHDRM	111	ACJS-MVD985-3S	110	ACPS-GN-AU	106
AC6AMPNZ	29	AC-BNC-JJA-75T	91	ACJM-MHOM	111	ACJS-MVD985-5	110	ACPS-GN BULK	106
AC6AMPNZ-AU	29	AC-BNC-JS-75	91	ACJM-MHOP	111	ACJS-MVS-3	114	ACPS-KB	104
AC6AMPNZB	29	AC-BNC-JS-75B	91	ACJM-MHOP-1	111	ACJS-MVS-3S	114	ACPS-KB-AU	104
AC6AMPNZB-AU	29	AC-BNC-LABEL	92	ACJM-MHR	112	ACJS-MVS-5	114	ACPS-KB BULK	104
AC6AMPNZB BULK	29	AC-BNC-PJ-75	91	ACJM-MHS	112	ACJS-NH35	110	ACPS-KN	104
AC6AMPNZ BULK	29	AC-BNC-PJ-75B	91	ACJM-MIV-2	113	ACJS-NV35-3	110	ACPS-KN-AU	104
AC6AMPNZV	29	AC-BNC-PJA-75T	91	ACJM-MIV-2S	113	ACJS-NV35-3S	110	ACPS-KN BULK	104

Amphenol

INDEX

Part Number	Page	Part Number	Page	Part Number	Page	Part Number	Page	Part Number	Page
ACPS-RB	107	AP-6-14	78	EP-4-13PB	77	MP-4101-37P	128	MP-25042-54S	129
ACPS-RB-AU	107	AP-6-21	78	EP-4-14	77	MP-4101-37P-C	128	MP-25042-85L	129
ACPS-RB BULK	107	AP-6-22	78	EP-4-14B	77	MP-4101-54P	128	MP-25042-85S	129
ACPS-RN	107	AP-8-11	78	EP-5-11P	76	MP-4101-54P-C	128	MP-25042-150L	129
ACPS-RN-AU	107	AP-8-12	78	EP-5-11PB	76	MP-4101-85P	128	MP-25042-150S	129
ACPS-RN BULK	107	AP-8-13	78	EP-5-12	76	MP-4101-85P-C	128	MP-25043-13L	130
ACPS-TB	105	AP-8-14	78	EP-5-12B	76	MP-4101-150P	128	MP-25043-13S	130
ACPS-TB-AU	105	AP-8-21	78	EP-5-13P	77	MP-4101-150P-C	128	MP-25043-19L	130
ACPS-TB BULK	105	AP-8-22	78	EP-5-13PB	77	MP-4102-13P	129	MP-25043-19S	130
ACPS-TN	105	AX3F	4	EP-5-14	77	MP-4102-13P-C	129	MP-25043-25L	130
ACPS-TN-AU	105	AX3F-AU	4	EP-5-14B	77	MP-4102-19P	129	MP-25043-25S	130
ACPS-TN BULK	105	AX3FB	4	EP-6-11P	76	MP-4102-19P-C	129	MP-25043-37L	130
AC-RING-BLU	138	AX3FB-AU	4	EP-6-11PB	76	MP-4102-25P	129	MP-25043-37S	130
AC-RING-BLU-PK1	138	AX3FB BULK	4	EP-6-12	76	MP-4102-25P-C	129	MP-25043-54L	130
AC-RING-BLU-PK2	138	AX3F BULK	4	EP-6-12B	76	MP-4102-37P	129	MP-25043-54S	130
AC-RING-BRN	138	AX3M	4	EP-6-13P	77	MP-4102-37P-C	129	MP-25043-85L	130
AC-RING-GRN	138	AX3M-AU	4	EP-6-13PB	77	MP-4102-54P	129	MP-25043-85S	130
AC-RING-GRY	138	AX3MB	4	EP-6-14	77	MP-4102-54P-C	129	MP-25043-150L	130
AC-RING-ORG	138	AX3MB-AU	4	EP-6-14B	77	MP-4102-85P	129	MP-25043-150S	130
AC-RING-RED	138	AX3MB BULK	4	EP-8-11P	76	MP-4102-85P-C	129	MP-108300	131
AC-RING-RED-PK1	138	AX3M BULK	4	EP-8-11PB	76	MP-4102-150P	129	MP-108400	131
AC-RING-RED-PK2	138	AX4F	5	EP-8-12	76	MP-4102-150P-C	129	MP-108500	131
AC-RING-VIO	138	AX4F-AU	5	EP-8-12B	76	MP-4106-13S	128	MP-108600	131
AC-RING-WHT	138	AX4FB	5	EP-8-13P	77	MP-4106-13S-C	128	MP-EXT-16/18	131
AC-RING-YEL	138	AX4FB-AU	5	EP-8-13PB	77	MP-4106-19S	128	MP-GUIDE-16	131
AC-RING-YEL-PK1	138	AX4FB BULK	5	EP-8-14	77	MP-4106-19S-C	128	MP-GUIDE-18	131
AC-RING-YEL-PK2	138	AX4F BULK	5	EP-8-14B	77	MP-4106-25S	128	MP-INS-16	131
AG3F	123	AX4M	4			MP-4106-25S-C	128	MP-INS-18	131
AG3FCCH	123	AX4M-AU	4	J		MP-4106-37S	128	R	
AG3FCE	123	AX4MB	5	JM2P	101	MP-4106-37S-C	128	RJX8FA3HB	85
AG3FCRV	124	AX4MB-AU	5	JM2P-AU	101	MP-4106-54S	128	RJX8FB5HB	85
AG3FL	123	AX4MB BULK	5	JM2PB	101	MP-4106-54S-C	128	RJX8FB5HEB	85
AG3M	123	AX4M BULK	4	JM2PB-AU	101	MP-4106-85S	128	RJX8FB5HGRB	85
AG3MCC	123	AX5F	5	JM2PB BULK	101	MP-4106-85S-C	128	RJX8FB5HGREG	85
AG3MCCH	123	AX5F-AU	5	JM2P BULK	101	MP-4106-150S	128	RJX8FB5HGYB	85
AG4F	123	AX5FB	5	JS3P	101	MP-4106-150S-C	128	RJX8FB5HGYE	85
AG4FCCH	123	AX5FB-AU	5	JS3P-AU	101	MP-4164-13S	129	RJX8FB5HRGB	85
AG4FCE	123	AX5FB BULK	5	JS3PB	101	MP-4164-13S-C	129	RJX8FB5HRGB	85
AG4FCRV	124	AX5F BULK	5	JS3PB-AU	101	MP-4164-19S	129	RJX8FB5HRGEB	85
AG4FL	123	AX5M	5	JS3PB BULK	101	MP-4164-19S-C	129	RJX8FB5HRRB	85
AG4M	123	AX5M-AU	5			MP-4164-25S	129	RJX8FB5HRRB	85
AG4MCC	123	AX5MB	5	K		MP-4164-25S-C	129	RJX8FB5HRYB	85
AG4MCCH	123	AX5MB-AU	5	KM2P	119	MP-4164-37S	129	RJX8FB5HRYE	85
AG4MPCH	124	AX5MB BULK	5	KM2P-AU	119	MP-4164-37S-C	129	RJX8FB5HUUB	85
AG5F	123	AX5M BULK	5	KM2PB	119	MP-4164-54S	129	RJX8FB5HUU	85
AG5FCCH	123	AX-BOOT	138	KM2PB-AU	119	MP-4164-54S-C	129	RJX8M	81
AG5FCE	123	AX-BOOT-1	138	KM2PB BULK	119	MP-4164-85S	129	RJX8MB	81
AG5FCRV	124	AX-BOOT-2	138	KM2P BULK	119	MP-4164-85S-C	129	RJX8MB BULK	81
AG5FL	123	AX-BOOT-3	138	KS3P	119	MP-4164-150S	129	RJX8M BULK	81
AG5M	123	AX-BOOT-4	138	KS3P-AU	119	MP-4164-150S-C	129		
AG5MCC	123	AX-BOOT-5	138	KS3PB	119	MP-6211-39S	133	S	
AG5MCCH	123	AX-BOOT-6	138	KS3PB-AU	119	MP-6211-39S-C	133	SP-2-F	68
AG6F	123	AX-BOOT-7	138	KS3PB BULK	119	MP-6211-61S	133	SP-2-FB	68
AG6FCCH	123	AX-BOOT-8	138	KS3P BULK	119	MP-6211-61S-C	133	SP-2-FBG	68
AG6FCE	123	AX-BOOT-9	138	KS3P BULK	119	MP-6216-39P	133	SP-2-FBL	68
AG6FCRV	124	AX-BOOT-CLR	138	KS3PC	119	MP-6216-39P-C	133	SP-2-FBS	68
AG6FL	123			KS3PC-AU	119	MP-6216-61P	133	SP-2-FBSG	68
AG6M	123	B				MP-6216-61P-C	133	SP-2-FBSL	68
AG6MCC	123	BNC-U-LINK 75*1	91	M		MP-6511-39S	133	SP-2-FG	68
AG6MCCH	123			M22520/1-01	131	MP-6511-39S-C	133	SP-2-FH	68
AP-4-11	78	E		MP-738-39L	134	MP-6511-61S	133	SP-2-FI	68
AP-4-12	78			MP-738-39S	134	MP-6511-61S-C	133	SP-2-FN	68
AP-4-13	78	EP-3-11P	76	MP-738-61L	134	MP-6516-39P	133	SP-2-FNG	68
AP-4-14	78	EP-3-11PB	76	MP-738-61S	134	MP-6516-39P-C	133	SP-2-FNL	68
AP-4-21	78	EP-3-12	76	MP-742-39L	134	MP-6516-61P	133	SP-2-FNS	68
AP-4-22	78	EP-3-12B	76	MP-742-39S	134	MP-6516-61P-C	133	SP-2-FNSG	68
AP-5-11	78	EP-3-13P	77	MP-742-61L	134	MP-25042-13L	129	SP-2-FNSL	68
AP-5-12	78	EP-3-13PB	77	MP-742-61S	134	MP-25042-13S	129	SP-2-FS	68
AP-5-13	78	EP-3-14	77	MP-4101-13P	128	MP-25042-19L	129	SP-2-FSG	68
AP-5-14	78	EP-3-14B	77	MP-4101-13P-C	128	MP-25042-19S	129	SP-2-FSL	68
AP-5-21	78	EP-4-11P	76	MP-4101-19P	128	MP-25042-25L	129	SP-2-MD	70
AP-5-22	78	EP-4-11PB	76	MP-4101-19P-C	128	MP-25042-25S	129	SP-2-MDH	70
AP-6-11	78	EP-4-12	76	MP-4101-25P	128	MP-25042-37L	129	SP-2-MDV	70
AP-6-12	78	EP-4-12B	76	MP-4101-25P-C	128	MP-25042-37S	129	SP-4-F	69
AP-6-13	78	EP-4-13P	77	MP-4101-25P-C	128	MP-25042-54L	129	SP-4-FB	69



Part Number	Page	Part Number	Page	Part Number	Page	Part Number	Page	Part Number	Page
SP-4-FBG	69	SP-4-MDH	70	TM1PBJ	99	TM2P BULK	97	TS3PBJ	97
SP-4-FBL	69	SP-4-MDHT	71	TM1P BULK	99	TM2PJ	97	TS3PBM	98
SP-4-FBS	69	SP-4-MDHT-8	70	TM1PJ	99	TM2PN	98	TS3PBM-AU	98
SP-4-FBSG	69	SP-4-MDT	70	TM1RBJ	99	TM2PN-AU	98	TS3PBM BULK	98
SP-4-FBSL	69	SP-4-MDV	71	TM1RBJ-AU	99	TM2PN BULK	98	TS3PBMJ	98
SP-4-FG	69	SP-4-MDV-2	71	TM1RBJ BULK	99	TM2PNJ	98	TS3P BULK	97
SP-4-FL	69	SP-4-MDVT-8	71	TM1RJ	99	TM2R	98	TS3PJ	97
SP-4-FN	69			TM1RJ-AU	99	TM2RB	98	TS3PN	98
SP-4-FNG	69	T		TM1RJ BULK	99	TM2RBJ	98	TS3PN-AU	98
SP-4-FNL	69			TM2P	97	TM2RBJ-AU	98	TS3PN BULK	98
SP-4-FNS	69	T2860	137	TM2P-AU	97	TM2RBJ BULK	98	TS3PNJ	98
SP-4-FNSG	69	T2880	137	TM2PB	97	TM2RJ	98	TS3R	98
SP-4-FNSL	69	T2890	137	TM2PB-AU	97	TM2RJ-AU	98	TS3RB	98
SP-4-FS	69	TH29-1	131	TM2PB BULK	97	TM2RJ BULK	98	TS3RBJ	98
SP-4-FSG	69	TM1P	99	TM2PBJ	97	TS3P	97	TS3RBJ-AU	98
SP-4-FSL	69	TM1P-AU	99	TM2PBM	98	TS3P-AU	97	TS3RBJ BULK	98
SP-4-MC	71	TM1PB	99	TM2PBM-AU	98	TS3PB	97	TS3RJ	98
SP-4-MD	70	TM1PB-AU	99	TM2PBM BULK	98	TS3PB-AU	97	TS3RJ-AU	98
SP-4-MD-8	70	TM1PB BULK	99	TM2PBMJ	98	TS3PB BULK	97	TS3RJ BULK	98

PRODUCT SAFETY INFORMATION

This should be read in conjunction with Data Sheet information contained in individual product brochures. Failure to observe the advice in this information sheet and the operating conditions specified in the Data Sheets could result in hazardous situations.

1. Material Content and Physical Form

Electrical connectors do not usually contain hazardous materials. They contain conducting and non-conducting materials. Shells are manufactured in metal and plastic. Insulators can be formed in either natural rubber, synthetic rubber, plastic or glass insulating materials. Contact materials vary with the type of connector and its application. They are usually manufactured from either copper alloys, nickel, alumel, chromel or steel. In special applications, other alloys may be specified.

2. Fire Characteristics and Electric Shock Hazard

There is no fire hazard when the connector is correctly wired and used within the specified parameters. Incorrect wiring or assembly of the connector or careless use of metal tools or conductive fluids, or transit damage to any of the component parts may cause electric shock or burns. Live circuits must not be broken by separating mated connectors as this may cause arcing, ionisation and burning. Heat dissipation is greater at maximum resistance in a circuit. Hot spots may occur when resistance is raised locally by damage, e.g. cracked or deformed contacts, or broken strands of wire. Local overheating may also result from the use of the incorrect application tools or from poor quality soldering.

Overheating may occur if the ratings in the Data Sheets are exceeded and can cause breakdown of insulation and hence electric shock.

If heating is allowed to continue it intensifies by further increasing the local resistance through loss of temper or spring contact, formation of oxide film on contacts and wires, and leakage currents through carbonisation of insulation and tracking points. Fire can then result in the presence of combustible materials and this may release noxious fumes. Overheating may not be visually apparent. Burns may result from touching overheated components.

3. Handling

Care must be taken to avoid damage to any component parts of electrical connectors during installation and use. Although there are normally no sharp edges, care must be taken when handling certain components to avoid injury to fingers. Electrical connectors may be damaged in transit to customers, and damage may result in creation of hazards. Products should therefore be examined prior to installation/use and rejected if found to be damaged.

4. Disposal

Incineration of certain materials may release noxious or even toxic fumes.

5. Application

Connectors with exposed contacts should not be selected for use on the current supply side of an electrical circuit, because an electric shock could result from touching exposed contacts of an unmated connector. Voltages in excess of 30 V.A.C. or 42.5

V.D.C. are potentially hazardous and care should be taken to ensure that such voltages cannot be transmitted in any way to exposed metal parts of the connector body. The connector and wiring should be checked, before making live, to have no damage to metal parts or insulators, no solder blobs, loose strands, conducting lubricants, swarf, or any other undesired conducting particles. Circuit resistance and continuity check should be made to make certain that there are no low resistance joints or spurious conducting paths. Always use the correct application tools as specified in the Data Sheets. Do not permit untrained personnel to wire, assemble or tamper with connectors. For operation voltage please see appropriate national regulations.

Important General Information

A) Air and creepage paths / Operating voltage.

The admissible operating voltages depend on the individual applications and the valid national and other applicable safety regulations. For this reason the air and creepage path data are only reference values. Observe reduction of air and creepage paths due to PC board and/or harnessing.

B) Other important information

Amphenol Australia Pty Ltd continuously endeavours to improve its products. Therefore, products may deviate from the description, technical data and shape as shown in product brochures.

C) Assembly instructions

If applicable, special assembly instructions have been included in or on the connector packaging. See also separate instructions in product brochures.

DISTRIBUTED BY

Amphenol Australia Pty Ltd

20 Industry Blvd.
Carrum Downs VIC 3201
Australia

Phone: +61 3 8796 8888
Fax: +61 3 8796 8801
Email: info@amphenol.com.au
Web: www.amphenolaudio.com

Amphenol Audio USA

Sales Office
P.O. Box 11401
Denver CO 80211 USA

Warehouse
5069 Maureen Lane, Unit B
Moorpark CA 93120 USA

Email: sales@amphenolaudio.com
Web: www.amphenolaudio.com

© 2013 Amphenol Australia Pty Ltd

Subject to all applicable laws and regulations Amphenol Australia Pty Ltd reserves the right to change specifications of any product, system or service contained in this brochure without liability.

Catalogue Part Number: CAT-AUDIO-01

Данный компонент на территории Российской Федерации

Вы можете приобрести в компании MosChip.

Для оперативного оформления запроса Вам необходимо перейти по данной ссылке:

<http://moschip.ru/get-element>

Вы можете разместить у нас заказ для любого Вашего проекта, будь то серийное производство или разработка единичного прибора.

В нашем ассортименте представлены ведущие мировые производители активных и пассивных электронных компонентов.

Нашей специализацией является поставка электронной компонентной базы двойного назначения, продукции таких производителей как XILINX, Intel (ex.ALTERA), Vicor, Microchip, Texas Instruments, Analog Devices, Mini-Circuits, Amphenol, Glenair.

Сотрудничество с глобальными дистрибьюторами электронных компонентов, предоставляет возможность заказывать и получать с международных складов практически любой перечень компонентов в оптимальные для Вас сроки.

На всех этапах разработки и производства наши партнеры могут получить квалифицированную поддержку опытных инженеров.

Система менеджмента качества компании отвечает требованиям в соответствии с ГОСТ Р ИСО 9001, ГОСТ РВ 0015-002 и ЭС РД 009

Офис по работе с юридическими лицами:

105318, г.Москва, ул.Щербаковская д.3, офис 1107, 1118, ДЦ «Щербаковский»

Телефон: +7 495 668-12-70 (многоканальный)

Факс: +7 495 668-12-70 (доб.304)

E-mail: info@moschip.ru

Skype отдела продаж:

moschip.ru

moschip.ru_4

moschip.ru_6

moschip.ru_9