

## CARMEN-W-C-WHT

~55° wide beam. Assembly with holder C compatible with HEKLA sockets and connectors. White version.

### TECHNICAL SPECIFICATIONS:

Dimensions	Ø 69.5 mm
Height	41.5 mm
Fastening	socket
ROHS compliant	yes ⓘ

### MATERIAL SPECIFICATIONS:

Component	Type	Material	Colour	Finish
CARMEN-W	Single lens	PMMA	clear	
CARMEN-HLD-C-WHT	Holder	PC	white	



### ORDERING INFORMATION:

Component		Qty in box	MOQ	MPQ	Box weight (kg)
CP16939_CARMEN-W-C-WHT	Single lens	150	150	15	6.2
» Box size: 476 x 273 x 292 mm					

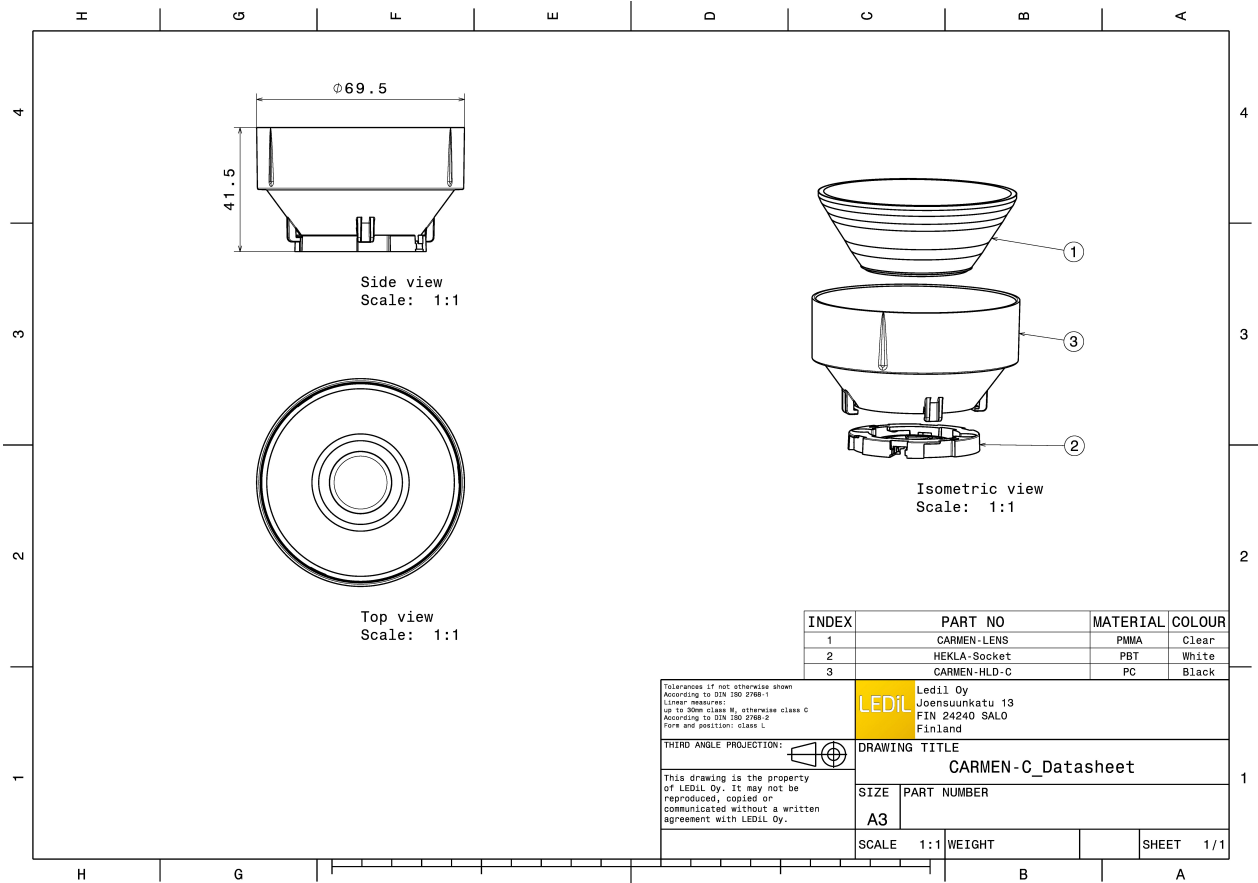

#### PHOTOMETRIC DATA (MEASURED):

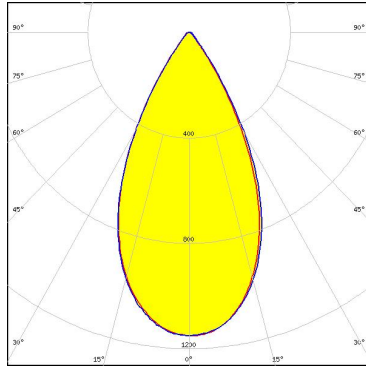
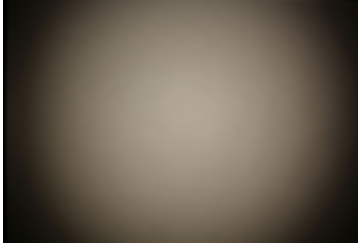
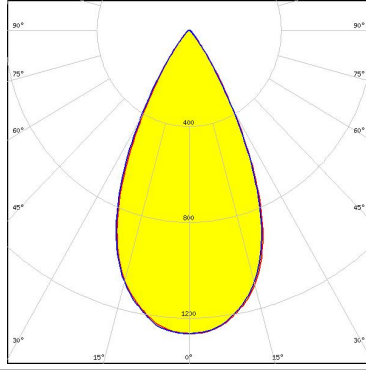
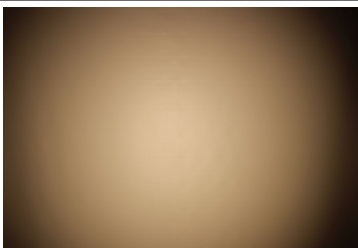
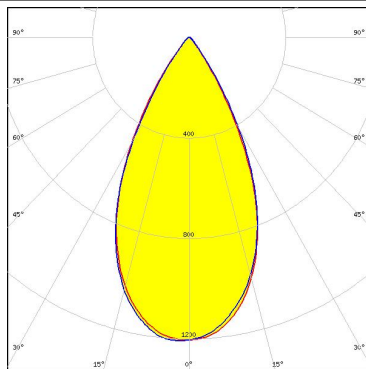
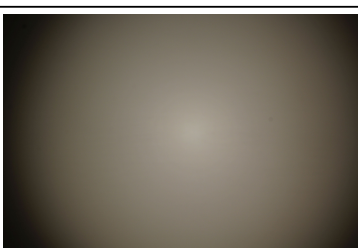
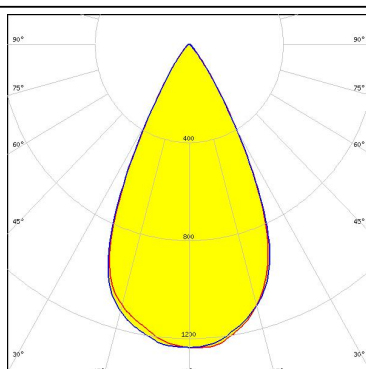
<p>bridgelux</p> <p>LED Vesta TW 9mm (9W) DP            FWHM 52.0°            Efficiency 88 %            Peak intensity 1.2 cd/lm            LEDs/each optic 1            Light colour White            Required components:            C16142_HEKLA-SOCKET-K            Bender Wirth: 489 Typ L8</p>		
<p><b>CITIZEN</b></p> <p>LED CLU700/701/702            FWHM 52.0°            Efficiency 92 %            Peak intensity 1.3 cd/lm            LEDs/each optic 1            Light colour White            Required components:            F15255_HEKLA-SOCKET-C</p>		
<p><b>CITIZEN</b></p> <p>LED CLU710/711            FWHM 53.0°            Efficiency 89 %            Peak intensity 1.2 cd/lm            LEDs/each optic 1            Light colour White            Required components:            F15859_HEKLA-SOCKET-I</p>		
<p><b>CITIZEN</b></p> <p>LED CLU7B2            FWHM 53.0°            Efficiency 93 %            Peak intensity 1.2 cd/lm            LEDs/each optic 1            Light colour White            Required components:            F15255_HEKLA-SOCKET-C</p>		

#### PHOTOMETRIC DATA (MEASURED):



LED CXA/B 15xx  
 FWHM 55.0°  
 Efficiency 91 %  
 Peak intensity 1.1 cd/lm  
 LEDs/each optic 1  
 Light colour White  
 Required components:  
 F15256\_HEKLA-SOCKET-D

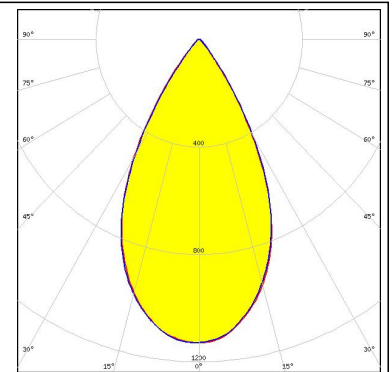
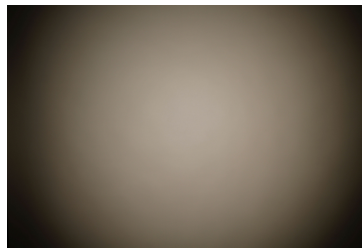

LED LUXEON CX Plus CoB - HD S01H4  
 FWHM 50.0°  
 Efficiency 89 %  
 Peak intensity 1.3 cd/lm  
 LEDs/each optic 1  
 Light colour White  
 Required components:  
 Bender Wirth: 634c Hekla

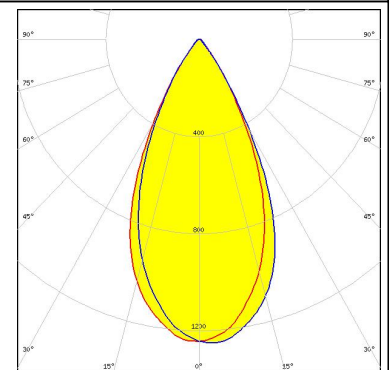
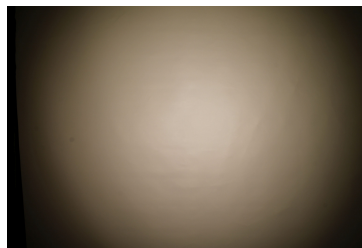

LED LUXEON CX Plus CoB - HD S01H6 / HD S02H6  
 FWHM 51.0°  
 Efficiency 89 %  
 Peak intensity 1.2 cd/lm  
 LEDs/each optic 1  
 Light colour White  
 Required components:  
 Bender Wirth: 634c Hekla

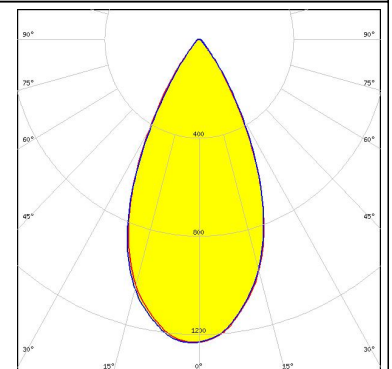

LED LUXEON CX Plus CoB - HD S04H9  
 FWHM 53.0°  
 Efficiency 88 %  
 Peak intensity 1.1 cd/lm  
 LEDs/each optic 1  
 Light colour White  
 Required components:  
 Bender Wirth: 634c Hekla

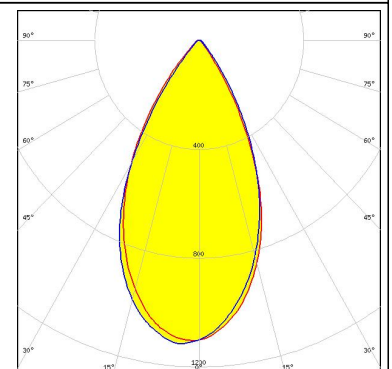
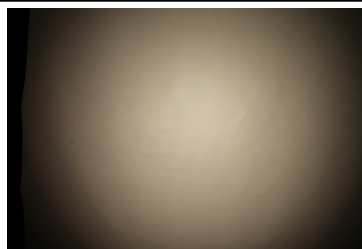

#### PHOTOMETRIC DATA (MEASURED):



LED LUXEON Fusion 21-up (20x24)  
 FWHM 48.0°  
 Efficiency 88 %  
 Peak intensity 1.3 cd/lm  
 LEDs/each optic 21  
 Light colour White  
 Required components:  
 C16142\_HEKLA-SOCKET-K  
 Bender Wirth: 442 Typ L8

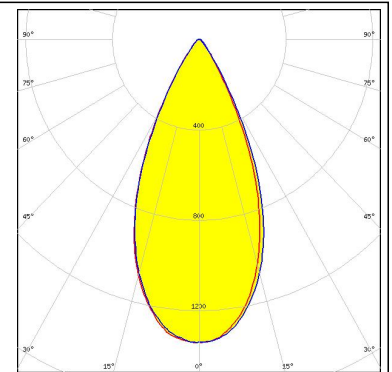
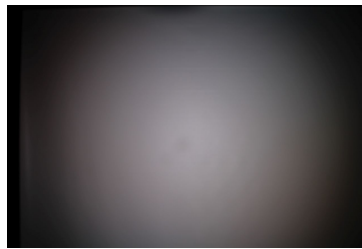

LED CXM-3  
 FWHM 53.0°  
 Efficiency 95 %  
 Peak intensity 1.3 cd/lm  
 LEDs/each optic 1  
 Light colour White  
 Required components:  
 F15255\_HEKLA-SOCKET-C

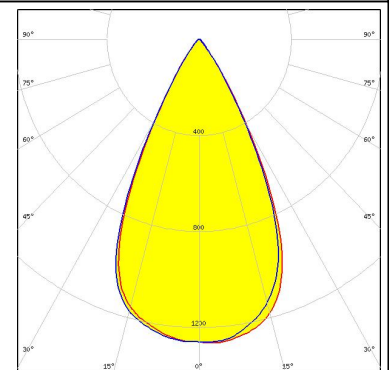
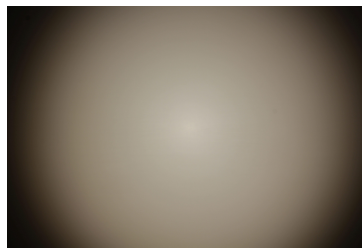

LED CXM-4  
 FWHM 52.0°  
 Efficiency 92 %  
 Peak intensity 1.3 cd/lm  
 LEDs/each optic 1  
 Light colour White  
 Required components:  
 F15255\_HEKLA-SOCKET-C

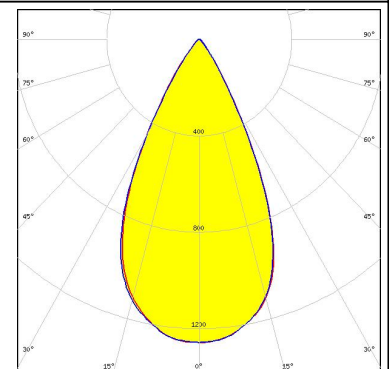
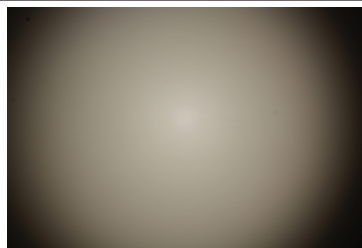

LED LC010T (Tunable White)  
 FWHM 52.0°  
 Efficiency 87 %  
 Peak intensity 1.2 cd/lm  
 LEDs/each optic 1  
 Light colour Tunable White  
 Required components:  
 C16142\_HEKLA-SOCKET-K  
 Bender Wirth: 501 Typ L8

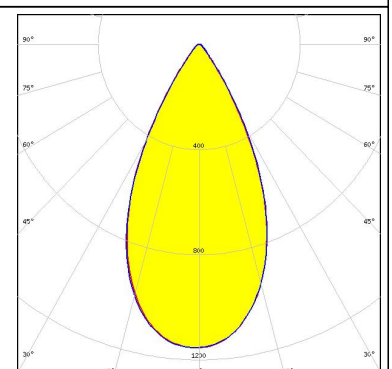
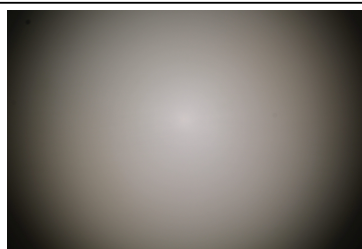

### PHOTOMETRIC DATA (MEASURED):

#### XICATO

LED XOB 6 mm  
FWHM 54.0°  
Efficiency 91 %  
Peak intensity 1.2 cd/lm  
LEDs/each optic 1  
Light colour White  
Required components:  
F15255\_HEKLA-SOCKET-C

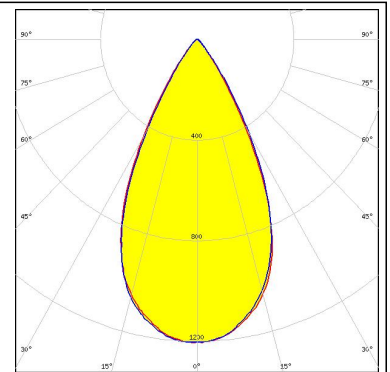

#### XICATO

LED XOB 9.8 mm  
FWHM 54.0°  
Efficiency 90 %  
Peak intensity 1.1 cd/lm  
LEDs/each optic 1  
Light colour White  
Required components:  
F15255\_HEKLA-SOCKET-C

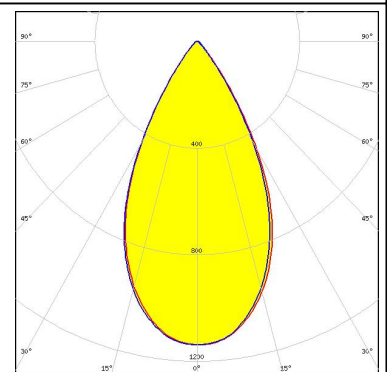
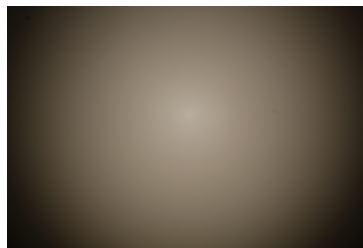

## PHOTOMETRIC DATA (SIMULATED):

### CITIZEN

LED	CLL02x/CLU02x (LES10)
FWHM	54.0°
Efficiency	87 %
Peak intensity	1.2 cd/lm
LEDs/each optic	1
Light colour	White
Required components:	

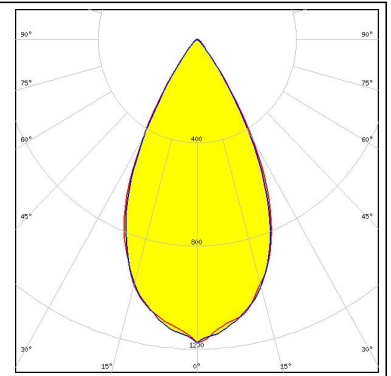

#### GENERAL INFORMATION:

NOTE: The typical beam angle will be changed by different color, chip size and chip position tolerance. The typical total beam angle is the full angle measured where the luminous intensity is half of the peak value.

Due to use of high power COB's with this product, special attention to proper thermal design is highly recommended. LEDiL has no liability for direct, indirect or consecutive damages arising from the LEDiL products being used outside of the recommended temperature range.

#### MATERIALS:

As part of our continuous research and improvement processes, and to ensure the best possible quality and availability of our products, LEDiL reserves the right to change material grades without notice.

#### PRODUCT DATA USER AGREEMENT AND DISCLAIMER:

The measured data in the provided downloadable LEDiL Product Datasheets and Mechanical 2D-Drawings is rounded and provided as reference for planning. LEDiL Oy's optical specifications have been verified by conducting performance testing of the products in accordance with the company's quality system. The reported data are averaged results of multiple measurements with typical variation. LEDiL Oy reserves the right to without prior notification make changes and improvements to its products.

LEDiL Oy assumes neither warranty, nor guarantee nor any other liability of any kind for the contents and correctness of the provided data. The provided data has been generated with highest diligence but the provided data may in reality not represent the complete possible variation range of all intrinsic parameters. Therefore, in certain cases a deviation from the provided data could occur.

LEDiL Oy reserves the right to undertake technical changes of its products without further notification which could lead to changes in the provided data. LEDiL Oy assumes no liability of any kind for the possible deviation from any provided data or any other damage resulting from the usage of the provided data.

The user agrees to this disclaimer and user agreement with the download or usage of the provided files.

#### LEDiL Oy

Joensuunkatu 13  
FI-24240 SALO  
Finland

#### LEDiL Inc.

228 West Page Street  
Suite D  
Sycamore IL 60178  
USA

#### Local sales and technical support

[www.ledil.com/where\\_to\\_buy](http://www.ledil.com/where_to_buy)

#### Shipping locations

Salo, Finland  
Hong Kong, China

#### Distribution Partners

[www.ledil.com/where\\_to\\_buy](http://www.ledil.com/where_to_buy)



## Данный компонент на территории Российской Федерации

### Вы можете приобрести в компании MosChip.

Для оперативного оформления запроса Вам необходимо перейти по данной ссылке:

<http://moschip.ru/get-element>

Вы можете разместить у нас заказ для любого Вашего проекта, будь то серийное производство или разработка единичного прибора.

В нашем ассортименте представлены ведущие мировые производители активных и пассивных электронных компонентов.

Нашей специализацией является поставка электронной компонентной базы двойного назначения, продукции таких производителей как XILINX, Intel (ex.ALTERA), Vicor, Microchip, Texas Instruments, Analog Devices, Mini-Circuits, Amphenol, Glenair.

Сотрудничество с глобальными дистрибьюторами электронных компонентов, предоставляет возможность заказывать и получать с международных складов практически любой перечень компонентов в оптимальные для Вас сроки.

На всех этапах разработки и производства наши партнеры могут получить квалифицированную поддержку опытных инженеров.

Система менеджмента качества компании отвечает требованиям в соответствии с ГОСТ Р ИСО 9001, ГОСТ РВ 0015-002 и ЭС РД 009

### Офис по работе с юридическими лицами:

105318, г.Москва, ул.Щербаковская д.3, офис 1107, 1118, ДЦ «Щербаковский»

Телефон: +7 495 668-12-70 (многоканальный)

Факс: +7 495 668-12-70 (доб.304)

E-mail: [info@moschip.ru](mailto:info@moschip.ru)

Skype отдела продаж:

moschip.ru

moschip.ru\_4

moschip.ru\_6

moschip.ru\_9