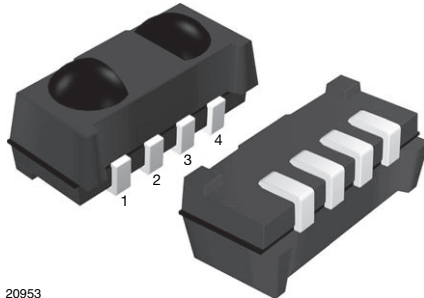


IR Receiver Modules for Remote Control Systems



20953

MECHANICAL DATA

Pinning:

 1, 4 = GND, 2 = V_S , 3 = OUT

ORDERING CODE

Taping:

TSOP75...TT - top view taped

TSOP75...TR - side view taped

FEATURES

- Very low supply current
- Photo detector and preamplifier in one package
- Compatible also with short burst dataformats
- Supply voltage: 2.5 V to 5.5 V
- Improved immunity against ambient light
- Capable of side or top view
- Two lenses for high sensitivity and wide receiving angle
- Insensitive to supply voltage ripple and noise
- Narrow optical filter to reduce interference from plasma TV emissions
- Material categorization: For definitions of compliance please see www.vishay.com/doc?99912



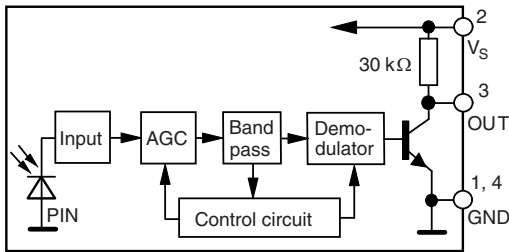
DESCRIPTION

The TSOP753.., TSOP755.. series are a two lens miniaturized receiver module for infrared remote control systems. One PIN diode per lens and a preamplifier are assembled on a leadframe, the epoxy lens cap is designed as an IR filter.

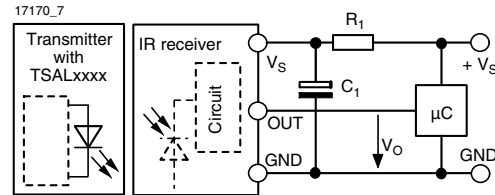
The demodulated output signal can be directly connected to a microprocessor for decoding. The TSOP753.. is optimized to better suppress spurious pulses from energy saving lamps. The TSOP755.. has an excellent noise suppression. It is immune to dimmed LCD backlighting and any fluorescent lamps. AGC3 and AGC5 may also suppress some data signals in case of continuous transmission.

This component has not been qualified according to automotive specifications.

PARTS TABLE			
AGC		NOISY ENVIRONMENTS AND SHORT BURSTS (AGC3)	VERY NOISY ENVIRONMENTS AND SHORT BURSTS (AGC5)
Carrier frequency	30 kHz	TSOP75330	TSOP75530
	33 kHz	TSOP75333	TSOP75533
	36 kHz	TSOP75336 ⁽¹⁾⁽²⁾	TSOP75536 ⁽¹⁾⁽²⁾
	38 kHz	TSOP75338 ⁽³⁾⁽⁴⁾⁽⁵⁾⁽⁶⁾	TSOP75538 ⁽³⁾⁽⁴⁾⁽⁵⁾
	40 kHz	TSOP75340	TSOP75540
	56 kHz	TSOP75356	TSOP75556
Package		Heimdall	
Pinning		1, 4 = GND, 2 = V_S , 3 = OUT	
Dimensions (mm)		6.8 W x 3.0 H x 3.2 D	
Mounting		SMD	
Application		Remote control	
Best remote control code		⁽¹⁾ MCIR ⁽²⁾ RCMM ⁽³⁾ Mitsubishi ⁽⁴⁾ RECS-80 Code ⁽⁵⁾ r-map ⁽⁶⁾ XMP-1, XMP-2	

BLOCK DIAGRAM


20445-1

APPLICATION CIRCUIT


The external components R_1 and C_1 are optional to improve the robustness against electrical overstress (typical values are $R_1 = 100 \Omega$, $C_1 = 0.1 \mu\text{F}$). The output voltage V_O should not be pulled down to a level below 1 V by the external circuit. The capacitive load at the output should be less than 2 nF.

ABSOLUTE MAXIMUM RATINGS

PARAMETER	TEST CONDITION	SYMBOL	VALUE	UNIT
Supply voltage		V_S	-0.3 to +6	V
Supply current		I_S	3	mA
Output voltage		V_O	-0.3 to ($V_S + 0.3$)	V
Output current		I_O	5	mA
Junction temperature		T_j	100	°C
Storage temperature range		T_{stg}	-25 to +85	°C
Operating temperature range		T_{amb}	-25 to +85	°C
Power consumption	$T_{amb} \leq 85 \text{ °C}$	P_{tot}	10	mW

Note

- Stresses beyond those listed under “Absolute Maximum Ratings” may cause permanent damage to the device. This is a stress rating only and functional operation of the device at these or any other conditions beyond those indicated in the operational sections of this specification is not implied. Exposure to absolute maximum rating conditions for extended periods may affect the device reliability.

ELECTRICAL AND OPTICAL CHARACTERISTICS ($T_{amb} = 25 \text{ °C}$, unless otherwise specified)

PARAMETER	TEST CONDITION	SYMBOL	MIN.	TYP.	MAX.	UNIT
Supply voltage		V_S	2.5		5.5	V
Supply current	$E_v = 0, V_S = 3.3 \text{ V}$	I_{SD}	0.27	0.35	0.45	mA
	$E_v = 40 \text{ klx, sunlight}$	I_{SH}		0.45		mA
Transmission distance	$E_v = 0$, test signal see fig. 1, IR diode TSAL6200, $I_F = 200 \text{ mA}$	d		45		m
Output voltage low	$I_{OSL} = 0.5 \text{ mA}$, $E_e = 0.7 \text{ mW/m}^2$, test signal see fig. 1	V_{OSL}			100	mV
Minimum irradiance	Pulse width tolerance: $t_{pi} - 5/f_o < t_{po} < t_{pi} + 6/f_o$, test signal see fig. 1	$E_e \text{ min.}$		0.12	0.25	mW/m^2
Maximum irradiance	$t_{pi} - 5/f_o < t_{po} < t_{pi} + 6/f_o$, test signal see fig. 1	$E_e \text{ max.}$	30			W/m^2
Directivity	Angle of half transmission distance	$\phi_{1/2}$		± 50		deg

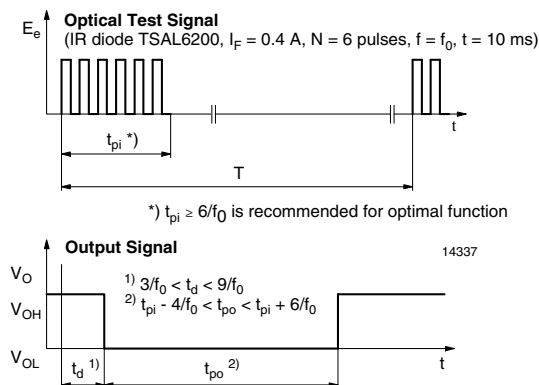
TYPICAL CHARACTERISTICS ($T_{amb} = 25 \text{ °C}$, unless otherwise specified)


Fig. 1 - Output Active Low

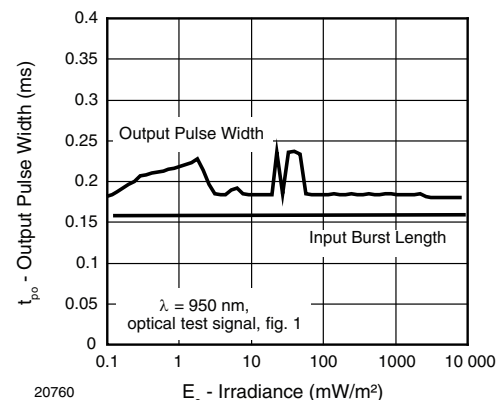


Fig. 2 - Pulse Length and Sensitivity in Dark Ambient

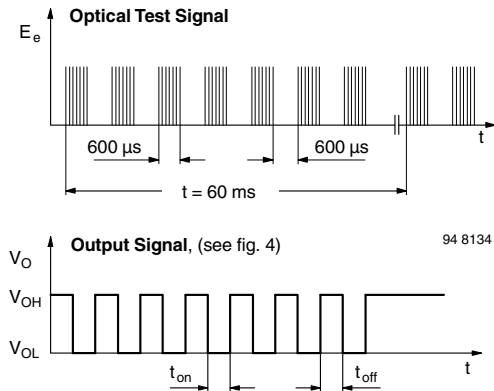


Fig. 3 - Output Function

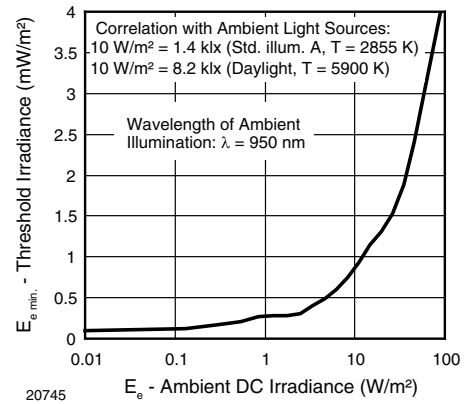


Fig. 6 - Sensitivity in Bright Ambient

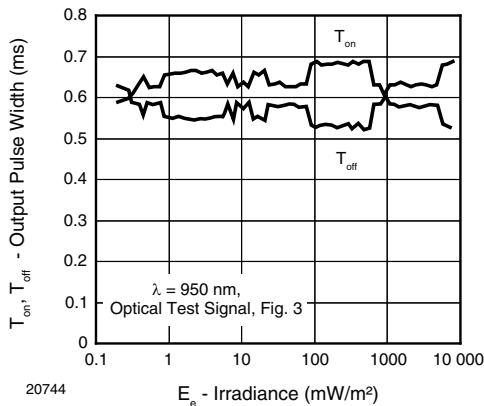


Fig. 4 - Output Pulse Diagram

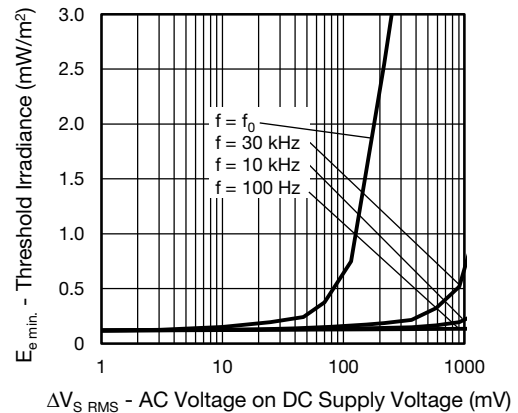


Fig. 7 - Sensitivity vs. Supply Voltage Disturbances

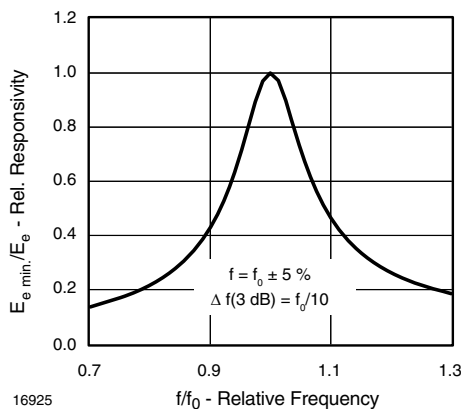


Fig. 5 - Frequency Dependence of Responsivity

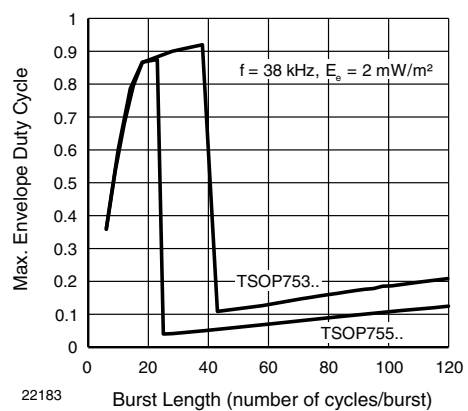


Fig. 8 - Max. Envelope Duty Cycle vs. Burst Length

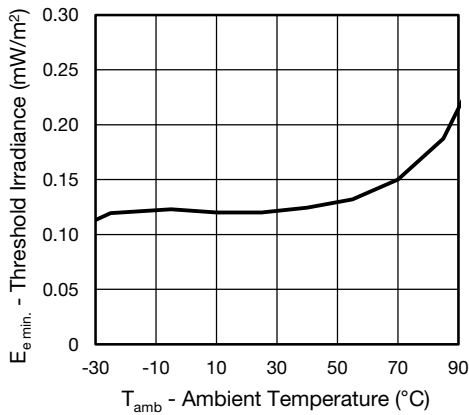


Fig. 9 - Sensitivity vs. Ambient Temperature

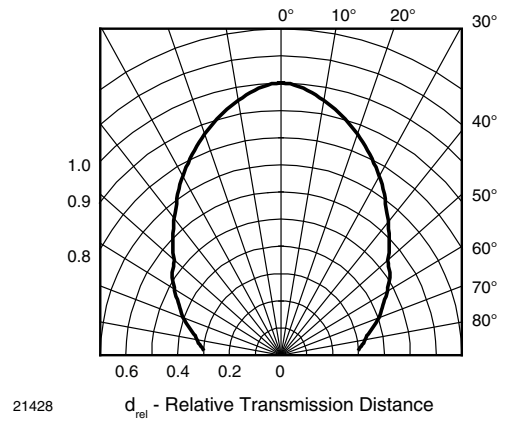


Fig. 12 - Vertical Directivity

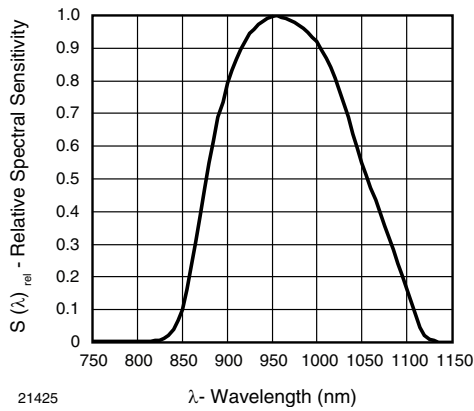


Fig. 10 - Relative Spectral Sensitivity vs. Wavelength

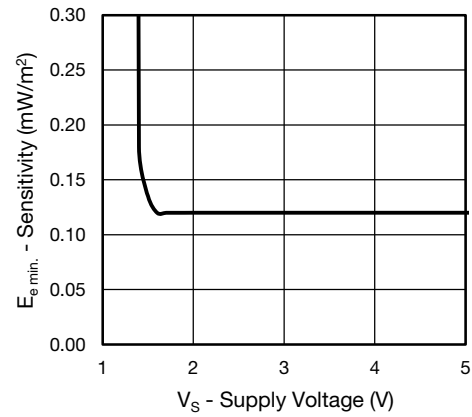


Fig. 13 - Sensitivity vs. Supply Voltage

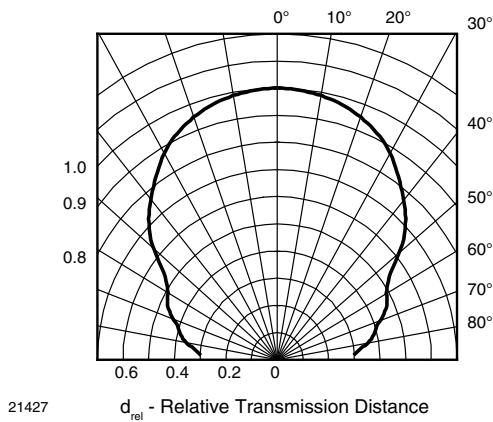


Fig. 11 - Horizontal Directivity

SUITABLE DATA FORMAT

The TSOP753.., TSOP755.. series are designed to suppress spurious output pulses due to noise or disturbance signals. Data and disturbance signals can be distinguished by the devices according to carrier frequency, burst length and envelope duty cycle. The data signal should be close to the band-pass center frequency (e.g. 38 kHz) and fulfill the conditions in the table below.

When a data signal is applied to the TSOP753.. and TSOP755.. in the presence of a disturbance signal, the sensitivity of the receiver is reduced to insure that no spurious pulses are present at the output. Some examples of disturbance signals which are suppressed are:

- DC light (e.g. from tungsten bulb or sunlight)
- Continuous signals at any frequency
- Strongly or weakly modulated pattern from fluorescent lamps with electronic ballasts (see fig. 14 or fig. 15)

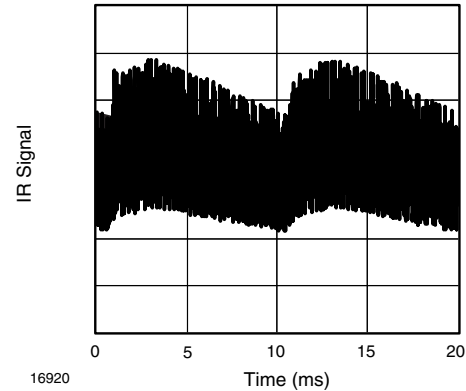


Fig. 14 - IR Discturbance from Fluorescent Lamp with Low Modulation

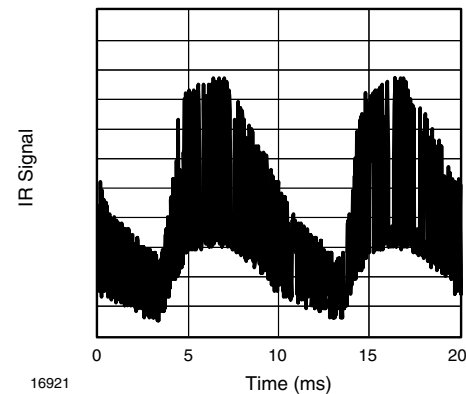


Fig. 15 - IR Discturbance from Fluorescent Lamp with High Modulation

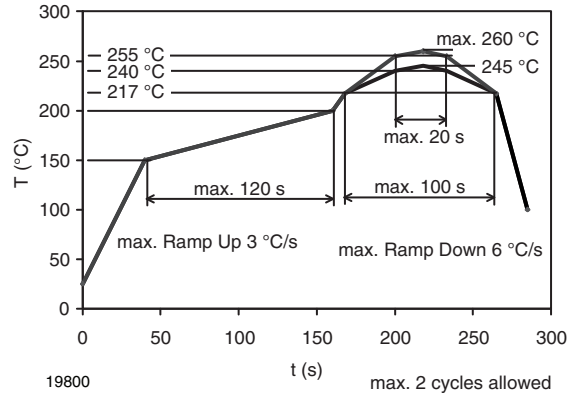
	TSOP753..	TSOP755..
Minimum burst length	6 cycles/burst	6 cycles/burst
After each burst of length a minimum gap time is required of	6 to 35 cycles ≥ 10 cycles	6 to 24 cycles ≥ 10 cycles
For bursts greater than a minimum gap time in the data stream is needed of	35 cycles > 4 x burst length	24 cycles > 25 ms
Maximum number of continuous short bursts/second	2000	2000
MCIR code	preferred	yes
RCMM code	preferred	yes
XMP-1, XMP-2 code	preferred	yes
Suppression of interference from fluorescent lamps	Most common disturbance patterns are suppressed	Most common disturbance patterns are suppressed

Notes

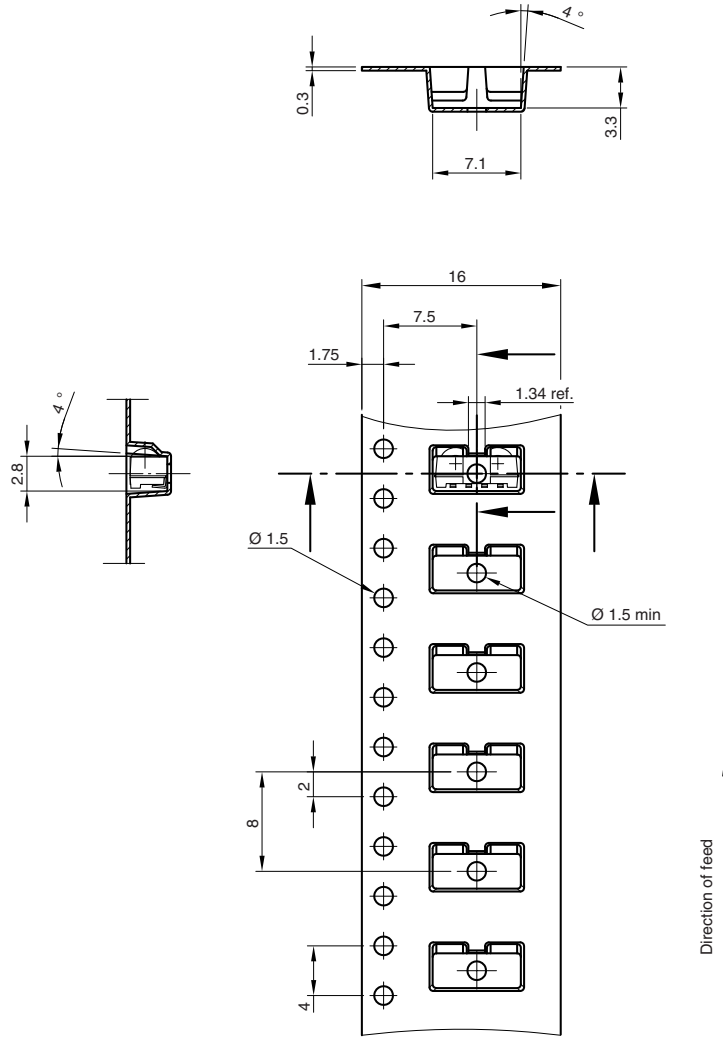
- For data formats with long bursts please see the datasheet for TSOP752.., TSOP754..
- Best choice of AGC for some popular IR-codes:
 - TSOP75336: MCIR, RCMM
 - TSOP75538: Mitsubishi, RECS-80 Code
 - TSOP75338: XMP-1, XMP-2, r-map
- For SIRCS 15 and 20 bit, Sony 12 bit IR-codes, please see the datasheet for TSOP75S40F



VISHAY LEAD (Pb)-FREE REFLOW SOLDER PROFILE



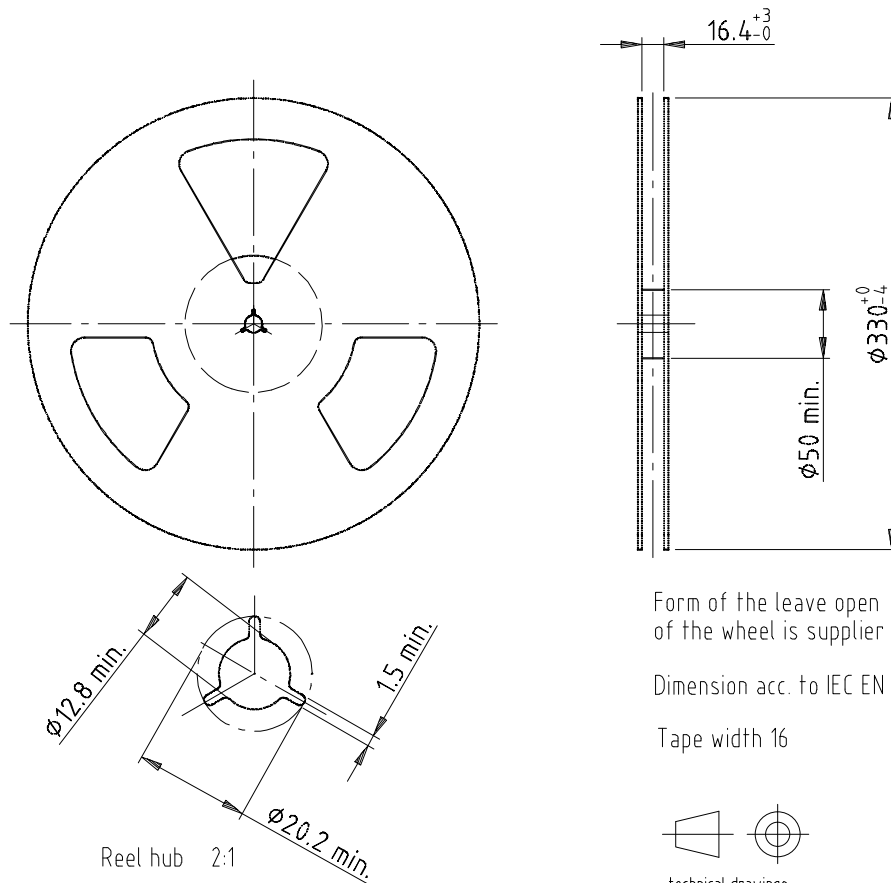
TAPING VERSION TSOP..TR DIMENSIONS in millimeters



technical drawings according to DIN specifications

Drawing-No.: 9.700-5337.01-4
Issue: 1; 16.10.08
21577

REEL DIMENSIONS in millimeters



Drawing-No.: 9.800-5052.V2-4

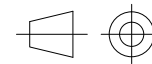
Issue: 1; 07.05.02

16734

Form of the leave open of the wheel is supplier specific.

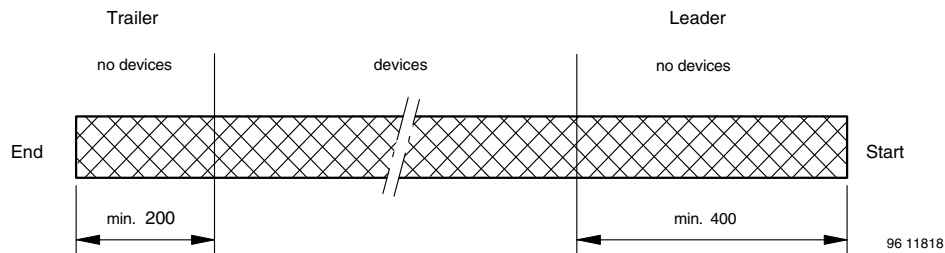
Dimension acc. to IEC EN 60 286-3

Tape width 16



technical drawings according to DIN specifications

LEADER AND TRAILER DIMENSIONS in millimeters



COVER TAPE PEEL STRENGTH

According to DIN EN 60286-3

0.1 N to 1.3 N

300 ± 10 mm/min.

165° to 180° peel angle

LABEL

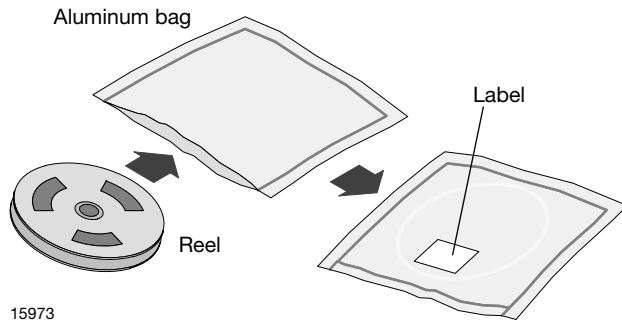
Standard bar code labels for finished goods

The standard bar code labels are product labels and used for identification of goods. The finished goods are packed in final packing area. The standard packing units are labeled with standard bar code labels before transported as finished goods to warehouses. The labels are on each packing unit and contain Vishay Semiconductor GmbH specific data.

VISHAY SEMICONDUCTOR GmbH STANDARD BAR CODE PRODUCT LABEL (Finished goods)		
PLAIN WRITING	ABBREVIATION	LENGTH
Item-description	-	18
Item-number	INO	8
Selection-code	SEL	3
LOT-/serial-number	BATCH	10
Data-code	COD	3 (YWW)
Plant-code	PTC	2
Quantity	QTY	8
Accepted by	ACC	-
Packed by	PCK	-
Mixed code indicator	MIXED CODE	-
Origin	xxxxxxx+	Company logo
LONG BAR CODE TOP	TYPE	LENGTH
Item-number	N	8
Plant-code	N	2
Sequence-number	X	3
Quantity	N	8
Total length	-	21
SHORT BAR CODE BOTTOM	TYPE	LENGTH
Selection-code	X	3
Data-code	N	3
Batch-number	X	10
Filter	-	1
Total length	-	17

DRY PACKING

The reel is packed in an anti-humidity bag to protect the devices from absorbing moisture during transportation and storage.



FINAL PACKING

The sealed reel is packed into a cardboard box. A secondary cardboard box is used for shipping purposes.

RECOMMENDED METHOD OF STORAGE

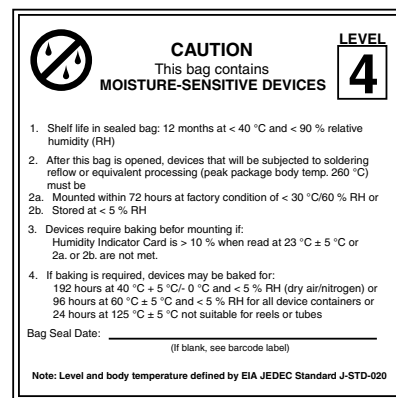
Dry box storage is recommended as soon as the aluminum bag has been opened to prevent moisture absorption. The following conditions should be observed, if dry boxes are not available:

- Storage temperature 10 °C to 30 °C
- Storage humidity ≤ 60 % RH max.

After more than 72 h under these conditions moisture content will be too high for reflow soldering.

In case of moisture absorption, the devices will recover to the former condition by drying under the following condition:
 192 h at 40 °C + 5 °C / - 0 °C and < 5 % RH (dry air/nitrogen) or
 96 h at 60 °C + 5 °C and < 5 % RH for all device containers or
 24 h at 125 °C + 5 °C not suitable for reel or tubes.

An EIA JEDEC® standard J-STD-020 level 4 label is included on all dry bags.



EIA JEDEC standard J-STD-020 level 4 label is included on all dry bags



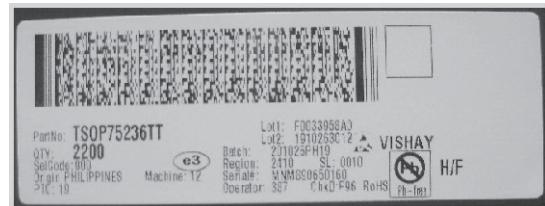
ESD PRECAUTION

Proper storage and handling procedures should be followed to prevent ESD damage to the devices especially when they are removed from the antistatic shielding bag. Electro-static sensitive devices warning labels are on the packaging.

VISHAY SEMICONDUCTORS STANDARD BAR CODE LABELS

The Vishay Semiconductors standard bar code labels are printed at final packing areas. The labels are on each packing unit and contain Vishay Semiconductors specific data.

BAR CODE PRODUCT LABEL (Example)



22178



Disclaimer

ALL PRODUCT, PRODUCT SPECIFICATIONS AND DATA ARE SUBJECT TO CHANGE WITHOUT NOTICE TO IMPROVE RELIABILITY, FUNCTION OR DESIGN OR OTHERWISE.

Vishay Intertechnology, Inc., its affiliates, agents, and employees, and all persons acting on its or their behalf (collectively, "Vishay"), disclaim any and all liability for any errors, inaccuracies or incompleteness contained in any datasheet or in any other disclosure relating to any product.

Vishay makes no warranty, representation or guarantee regarding the suitability of the products for any particular purpose or the continuing production of any product. To the maximum extent permitted by applicable law, Vishay disclaims (i) any and all liability arising out of the application or use of any product, (ii) any and all liability, including without limitation special, consequential or incidental damages, and (iii) any and all implied warranties, including warranties of fitness for particular purpose, non-infringement and merchantability.

Statements regarding the suitability of products for certain types of applications are based on Vishay's knowledge of typical requirements that are often placed on Vishay products in generic applications. Such statements are not binding statements about the suitability of products for a particular application. It is the customer's responsibility to validate that a particular product with the properties described in the product specification is suitable for use in a particular application. Parameters provided in datasheets and/or specifications may vary in different applications and performance may vary over time. All operating parameters, including typical parameters, must be validated for each customer application by the customer's technical experts. Product specifications do not expand or otherwise modify Vishay's terms and conditions of purchase, including but not limited to the warranty expressed therein.

Except as expressly indicated in writing, Vishay products are not designed for use in medical, life-saving, or life-sustaining applications or for any other application in which the failure of the Vishay product could result in personal injury or death. Customers using or selling Vishay products not expressly indicated for use in such applications do so at their own risk. Please contact authorized Vishay personnel to obtain written terms and conditions regarding products designed for such applications.

No license, express or implied, by estoppel or otherwise, to any intellectual property rights is granted by this document or by any conduct of Vishay. Product names and markings noted herein may be trademarks of their respective owners.

Material Category Policy

Vishay Intertechnology, Inc. hereby certifies that all its products that are identified as RoHS-Compliant fulfill the definitions and restrictions defined under Directive 2011/65/EU of The European Parliament and of the Council of June 8, 2011 on the restriction of the use of certain hazardous substances in electrical and electronic equipment (EEE) - recast, unless otherwise specified as non-compliant.

Please note that some Vishay documentation may still make reference to RoHS Directive 2002/95/EC. We confirm that all the products identified as being compliant to Directive 2002/95/EC conform to Directive 2011/65/EU.

Vishay Intertechnology, Inc. hereby certifies that all its products that are identified as Halogen-Free follow Halogen-Free requirements as per JEDEC JS709A standards. Please note that some Vishay documentation may still make reference to the IEC 61249-2-21 definition. We confirm that all the products identified as being compliant to IEC 61249-2-21 conform to JEDEC JS709A standards.

Данный компонент на территории Российской Федерации

Вы можете приобрести в компании MosChip.

Для оперативного оформления запроса Вам необходимо перейти по данной ссылке:

<http://moschip.ru/get-element>

Вы можете разместить у нас заказ для любого Вашего проекта, будь то серийное производство или разработка единичного прибора.

В нашем ассортименте представлены ведущие мировые производители активных и пассивных электронных компонентов.

Нашей специализацией является поставка электронной компонентной базы двойного назначения, продукции таких производителей как XILINX, Intel (ex.ALTERA), Vicor, Microchip, Texas Instruments, Analog Devices, Mini-Circuits, Amphenol, Glenair.

Сотрудничество с глобальными дистрибьюторами электронных компонентов, предоставляет возможность заказывать и получать с международных складов практически любой перечень компонентов в оптимальные для Вас сроки.

На всех этапах разработки и производства наши партнеры могут получить квалифицированную поддержку опытных инженеров.

Система менеджмента качества компании отвечает требованиям в соответствии с ГОСТ Р ИСО 9001, ГОСТ РВ 0015-002 и ЭС РД 009

Офис по работе с юридическими лицами:

105318, г.Москва, ул.Щербаковская д.3, офис 1107, 1118, ДЦ «Щербаковский»

Телефон: +7 495 668-12-70 (многоканальный)

Факс: +7 495 668-12-70 (доб.304)

E-mail: info@moschip.ru

Skype отдела продаж:

moschip.ru

moschip.ru_4

moschip.ru_6

moschip.ru_9