

Please read this notice before using the TAIYO YUDEN products.

REMINDERS

- Product information in this catalog is as of October 2017. All of the contents specified herein are subject to change without notice due to technical improvements, etc. Therefore, please check for the latest information carefully before practical application or use of our products.

Please note that TAIYO YUDEN shall not be in any way responsible for any damages and defects in products or equipment incorporating our products, which are caused under the conditions other than those specified in this catalog or individual product specification sheets.

- Please contact TAIYO YUDEN for further details of product specifications as the individual product specification sheets are available.
- Please conduct validation and verification of our products in actual condition of mounting and operating environment before using our products.
- The products listed in this catalog are intended for use in general electronic equipment (e.g., AV equipment, OA equipment, home electric appliances, office equipment, information and communication equipment including, without limitation, mobile phone, and PC) and medical equipment classified as Class I or II by IMDRF. Please be sure to contact TAIYO YUDEN for further information before using the products for any equipment which may directly cause loss of human life or bodily injury (e.g., transportation equipment including, without limitation, automotive powertrain control system, train control system, and ship control system, traffic signal equipment, disaster prevention equipment, medical equipment classified as Class III by IMDRF, highly public information network equipment including, without limitation, telephone exchange, and base station).

Please do not incorporate our products into any equipment requiring high levels of safety and/or reliability (e.g., aerospace equipment, aviation equipment*, medical equipment classified as Class IV by IMDRF, nuclear control equipment, undersea equipment, military equipment).

*Note: There is a possibility that our products can be used only for aviation equipment that does not directly affect the safe operation of aircraft (e.g., in-flight entertainment, cabin light, electric seat, cooking equipment) if such use meets requirements specified separately by TAIYO YUDEN. Please be sure to contact TAIYO YUDEN for further information before using our products for such aviation equipment.

When our products are used even for high safety and/or reliability-required devices or circuits of general electronic equipment, it is strongly recommended to perform a thorough safety evaluation prior to use of our products and to install a protection circuit as necessary.

Please note that unless you obtain prior written consent of TAIYO YUDEN, TAIYO YUDEN shall not be in any way responsible for any damages incurred by you or third parties arising from use of the products listed in this catalog for any equipment requiring inquiry to TAIYO YUDEN or prohibited for use by TAIYO YUDEN as described above.

- Information contained in this catalog is intended to convey examples of typical performances and/or applications of our products and is not intended to make any warranty with respect to the intellectual property rights or any other related rights of TAIYO YUDEN or any third parties nor grant any license under such rights.
- Please note that the scope of warranty for our products is limited to the delivered our products themselves and TAIYO YUDEN shall not be in any way responsible for any damages resulting from a fault or defect in our products. Notwithstanding the foregoing, if there is a written agreement (e.g., supply and purchase agreement, quality assurance agreement) signed by TAIYO YUDEN and your company, TAIYO YUDEN will warrant our products in accordance with such agreement.
- The contents of this catalog are applicable to our products which are purchased from our sales offices or authorized distributors (hereinafter "TAIYO YUDEN's official sales channel"). Please note that the contents of this catalog are not applicable to our products purchased from any seller other than TAIYO YUDEN's official sales channel.
- Caution for Export
Some of our products listed in this catalog may require specific procedures for export according to "U.S. Export Administration Regulations", "Foreign Exchange and Foreign Trade Control Law" of Japan, and other applicable regulations. Should you have any questions on this matter, please contact our sales staff.

WIRE-WOUND CHIP POWER INDUCTORS(CB SERIES)



REFLOW

■ PARTS NUMBER

* Operating Temp.: -40~+105°C (Including self-generated heat)



△=Blank space

① Series name

Code	Series name
CB	Wound chip power inductor

④ Packaging

Code	Packaging
T	Taping

② Characteristics

Code	Characteristics
△△	Standard
△C	High current
△L	Low profile
MF	Low loss

⑤ Nominal inductance

Code (example)	Nominal inductance [μH]
1R0	1.0
100	10
101	100

※R=Decimal point

③ Dimensions (L × W)

Code	Type (inch)	Dimensions (L × W) [mm]
1608	1608 (0603)	1.6 × 0.8
2012	2012 (0805)	2.0 × 1.25
2016	2016 (0806)	2.0 × 1.6
2518	2518 (1007)	2.5 × 1.8
3225	3225 (1210)	3.2 × 2.5

⑥ Inductance tolerance

Code	Inductance tolerance
K	±10%
M	±20%

⑦ Special code

Code	Special code
△	Standard
R	Low Rdc type

⑧ Internal code

■ STANDARD EXTERNAL DIMENSIONS / STANDARD QUANTITY

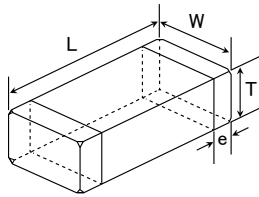

Recommended Land Patterns

Surface Mounting

- Mounting and soldering conditions should be checked beforehand.
- Applicable soldering process to these products is reflow soldering only.

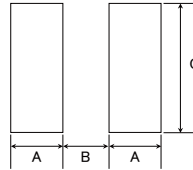

Type	A	B	C
MF1608	0.55	0.7	1.0
2012	0.60	1.0	1.45
2016	0.60	1.0	1.8
2518	0.60	1.5	2.0
3225	0.85	1.7	2.7

Unit: mm

Type	L	W	T	e	Standard quantity [pcs]	
					Paper tape	Embossed tape
CBMF1608	1.6±0.2 (0.063±0.008)	0.8±0.2 (0.031±0.008)	0.8±0.2 (0.031±0.008)	0.45±0.15 (0.016±0.006)	—	3000
CB L2012	2.0±0.2 (0.079±0.008)	1.25±0.2 (0.049±0.008)	0.9±0.1 (0.035±0.004)	0.5±0.2 (0.020±0.008)	4000	—
CB 2012	2.0±0.2	1.25±0.2	1.25±0.2	0.5±0.2	—	3000
CB C2012	(0.079±0.008)	(0.049±0.008)	(0.049±0.008)	(0.020±0.008)	—	3000
CB 2016	2.0±0.2	1.6±0.2	1.6±0.2	0.5±0.2	—	2000
CB C2016	(0.079±0.008)	(0.063±0.008)	(0.063±0.008)	(0.020±0.008)	—	2000
CB 2518	2.5±0.2	1.8±0.2	1.8±0.2	0.5±0.2	—	2000
CB C2518	(0.098±0.008)	(0.071±0.008)	(0.071±0.008)	(0.020±0.008)	—	2000
CB C3225	3.2±0.2 (0.126±0.008)	2.5±0.2 (0.098±0.008)	2.5±0.2 (0.098±0.008)	0.6±0.3 (0.024±0.012)	—	1000

Unit: mm (inch)

► This catalog contains the typical specification only due to the limitation of space. When you consider the purchase of our products, please check our product specification sheets. For details of each product (characteristics graph, reliability information, precautions for use, and so on), see our website (<http://www.ty-top.com/>).

■ PARTS NUMBER

● 1608 (0603) type

Parts number	EHS	Nominal inductance [μ H]	Inductance tolerance	Self-resonant frequency [MHz] (min.)	DC Resistance [Ω] ($\pm 30\%$)	Rated current ※) [mA]		Measuring frequency [MHz]
						Saturation current Idc1	Temperature rise current Idc2	
CBMF1608T1R0M	RoHS	1.0	$\pm 20\%$	100	0.09	290	770	7.96
CBMF1608T2R2M	RoHS	2.2	$\pm 20\%$	80	0.17	190	560	7.96
CBMF1608T3R3M	RoHS	3.3	$\pm 20\%$	60	0.22	170	500	7.96
CBMF1608T4R7M	RoHS	4.7	$\pm 20\%$	45	0.24	145	470	7.96
CBMF1608T100□	RoHS	10	$\pm 10\%, \pm 20\%$	32	0.36	115	380	2.52
CBMF1608T220□	RoHS	22	$\pm 10\%, \pm 20\%$	16	1.0	70	230	2.52
CBMF1608T470□	RoHS	47	$\pm 10\%, \pm 20\%$	11	2.5	50	140	2.52

● 2012 (0805) type

Parts number	EHS	Nominal inductance [μ H]	Inductance tolerance	Self-resonant frequency [MHz] (min.)	DC Resistance [Ω] ($\pm 30\%$)	Rated current ※) [mA]		Measuring frequency [MHz]
						Saturation current Idc1	Temperature rise current Idc2	
CB 2012T1R0M	RoHS	1.0	$\pm 20\%$	100	0.15	500	900	7.96
CB 2012T2R2M	RoHS	2.2	$\pm 20\%$	80	0.23	410	770	7.96
CB 2012T3R3M	RoHS	3.3	$\pm 20\%$	55	0.30	330	650	7.96
CB 2012T4R7M	RoHS	4.7	$\pm 20\%$	45	0.40	300	580	7.96
CB 2012T6R8M	RoHS	6.8	$\pm 20\%$	38	0.47	250	540	7.96
CB 2012T100□	RoHS	10	$\pm 10\%, \pm 20\%$	32	0.70	190	440	2.52
CB 2012T100□R	RoHS	10	$\pm 10\%, \pm 20\%$	32	0.50	200	520	2.52
CB 2012T150□	RoHS	15	$\pm 10\%, \pm 20\%$	28	1.3	170	320	2.52
CB 2012T220□	RoHS	22	$\pm 10\%, \pm 20\%$	16	1.7	135	280	2.52
CB 2012T470□	RoHS	47	$\pm 10\%, \pm 20\%$	11	3.7	90	190	2.52
CB 2012T680□	RoHS	68	$\pm 10\%, \pm 20\%$	10	6.0	70	140	2.52
CB 2012T101□	RoHS	100	$\pm 10\%, \pm 20\%$	8	7.0	60	130	0.796

Parts number	EHS	Nominal inductance [μ H]	Inductance tolerance	Self-resonant frequency [MHz] (min.)	DC Resistance [Ω] ($\pm 30\%$)	Rated current ※) [mA]		Measuring frequency [MHz]
						Saturation current Idc1	Temperature rise current Idc2	
CB C2012T1R0M	RoHS	1.0	$\pm 20\%$	100	0.19	700	840	7.96
CB C2012T2R2M	RoHS	2.2	$\pm 20\%$	70	0.33	530	640	7.96
CB C2012T4R7M	RoHS	4.7	$\pm 20\%$	45	0.50	360	520	7.96
CB C2012T100□	RoHS	10	$\pm 10\%, \pm 20\%$	40	1.2	240	340	2.52
CB C2012T220□	RoHS	22	$\pm 10\%, \pm 20\%$	16	3.7	170	190	2.52
CB C2012T470□	RoHS	47	$\pm 10\%, \pm 20\%$	11	5.8	120	150	2.52

Parts number	EHS	Nominal inductance [μ H]	Inductance tolerance	Self-resonant frequency [MHz] (min.)	DC Resistance [Ω] ($\pm 30\%$)	Rated current ※) [mA]		Measuring frequency [MHz]
						Saturation current Idc1	Temperature rise current Idc2	
CB L2012T1R0M	RoHS	1.0	$\pm 20\%$	100	0.15	620	950	0.1
CB L2012T2R2M	RoHS	2.2	$\pm 20\%$	80	0.39	440	590	0.1
CB L2012T4R7M	RoHS	4.7	$\pm 20\%$	45	0.66	275	490	0.1
CB L2012T100M	RoHS	10	$\pm 20\%$	32	1.0	205	370	0.1
CB L2012T220M	RoHS	22	$\pm 20\%$	23	2.1	150	250	0.1
CB L2012T470M	RoHS	47	$\pm 20\%$	11	4.2	100	140	0.1

● 2016 (0806) type

Parts number	EHS	Nominal inductance [μ H]	Inductance tolerance	Self-resonant frequency [MHz] (min.)	DC Resistance [Ω] ($\pm 30\%$)	Rated current ※) [mA]		Measuring frequency [MHz]
						Saturation current Idc1	Temperature rise current Idc2	
CB 2016T1R0M	RoHS	1.0	$\pm 20\%$	100	0.09	600	1,100	7.96
CB 2016T1R5M	RoHS	1.5	$\pm 20\%$	80	0.11	550	1,000	7.96
CB 2016T2R2M	RoHS	2.2	$\pm 20\%$	70	0.13	510	1,000	7.96
CB 2016T3R3M	RoHS	3.3	$\pm 20\%$	55	0.20	400	800	7.96
CB 2016T4R7M	RoHS	4.7	$\pm 20\%$	45	0.25	340	740	7.96
CB 2016T6R8M	RoHS	6.8	$\pm 20\%$	38	0.35	300	600	7.96
CB 2016T100□	RoHS	10	$\pm 10\%, \pm 20\%$	32	0.50	250	520	2.52
CB 2016T150□	RoHS	15	$\pm 10\%, \pm 20\%$	28	0.70	210	440	2.52
CB 2016T220□	RoHS	22	$\pm 10\%, \pm 20\%$	16	1.0	165	370	2.52
CB 2016T330□	RoHS	33	$\pm 10\%, \pm 20\%$	14	1.7	130	270	2.52
CB 2016T470□	RoHS	47	$\pm 10\%, \pm 20\%$	11	2.4	110	240	2.52
CB 2016T680□	RoHS	68	$\pm 10\%, \pm 20\%$	10	3.0	90	210	2.52
CB 2016T101□	RoHS	100	$\pm 10\%, \pm 20\%$	8	4.5	70	170	0.796

□ Please specify the Inductance tolerance code (Kor M)

- ※) The saturation current value (Idc1) is the DC current value having inductance decrease down to 30%. (at 20°C)
- ※) The temperature rise current value (Idc2) is the DC current value having temperature increase by 40°C. (at 20°C)
- ※) The rated current value is following either Idc1 or Idc2, which is the lower one.

■ PARTS NUMBER

Parts number	EHS	Nominal inductance [μH]	Inductance tolerance	Self-resonant frequency [MHz] (min.)	DC Resistance [Ω] (±30%)	Rated current ※) [mA]		Measuring frequency [MHz]
						Saturation current Idc1	Temperature rise current Idc2	
CB C2016T1R0M	RoHS	1.0	±20%	100	0.10	1,100	1,100	7.96
CB C2016T1R5M	RoHS	1.5	±20%	80	0.15	1,000	1,000	7.96
CB C2016T2R2M	RoHS	2.2	±20%	70	0.20	750	720	7.96
CB C2016T3R3M	RoHS	3.3	±20%	55	0.27	600	610	7.96
CB C2016T4R7M	RoHS	4.7	±20%	45	0.37	550	530	7.96
CB C2016T6R8M	RoHS	6.8	±20%	38	0.59	450	450	7.96
CB C2016T100□	RoHS	10	±10%, ±20%	32	0.82	380	350	2.52
CB C2016T150□	RoHS	15	±10%, ±20%	28	1.2	300	300	2.52
CB C2016T220□	RoHS	22	±10%, ±20%	16	1.8	250	240	2.52
CB C2016T330□	RoHS	33	±10%, ±20%	14	2.8	220	220	2.52
CB C2016T470□	RoHS	47	±10%, ±20%	11	4.3	150	150	2.52
CB C2016T680□	RoHS	68	±10%, ±20%	10	7.0	130	130	2.52
CB C2016T101□	RoHS	100	±10%, ±20%	8	8.0	110	110	0.796

● 2518(1007) type

Parts number	EHS	Nominal inductance [μH]	Inductance tolerance	Self-resonant frequency [MHz] (min.)	DC Resistance [Ω] (±30%)	Rated current ※) [mA]		Measuring frequency [MHz]
						Saturation current Idc1	Temperature rise current Idc2	
CB 2518T1R0M	RoHS	1.0	±20%	100	0.06	1,200	1,500	7.96
CB 2518T1R5M	RoHS	1.5	±20%	80	0.07	650	1,400	7.96
CB 2518T2R2M	RoHS	2.2	±20%	68	0.09	510	1,300	7.96
CB 2518T3R3M	RoHS	3.3	±20%	54	0.11	440	1,200	7.96
CB 2518T4R7MR	RoHS	4.7	±20%	46	0.10	310	1,200	7.96
CB 2518T4R7M	RoHS	4.7	±20%	46	0.13	340	1,100	7.96
CB 2518T6R8M	RoHS	6.8	±20%	38	0.15	270	930	7.96
CB 2518T100□	RoHS	10	±10%, ±20%	30	0.25	250	820	2.52
CB 2518T150□	RoHS	15	±10%, ±20%	23	0.32	180	650	2.52
CB 2518T220□	RoHS	22	±10%, ±20%	19	0.50	165	580	2.52
CB 2518T330□	RoHS	33	±10%, ±20%	15	0.70	130	460	2.52
CB 2518T470□	RoHS	47	±10%, ±20%	12	0.95	110	420	2.52
CB 2518T680□	RoHS	68	±10%, ±20%	9.5	1.5	70	310	2.52
CB 2518T101□	RoHS	100	±10%, ±20%	9.0	2.1	60	260	0.796
CB 2518T151□	RoHS	150	±10%, ±20%	7.0	3.2	55	210	0.796
CB 2518T221□	RoHS	220	±10%, ±20%	5.5	4.5	50	180	0.796
CB 2518T331□	RoHS	330	±10%, ±20%	4.5	7.0	40	140	0.796
CB 2518T471□	RoHS	470	±10%, ±20%	3.5	10	35	120	0.796
CB 2518T681□	RoHS	680	±10%, ±20%	3.0	17	30	90	0.796
CB 2518T102□	RoHS	1000	±10%, ±20%	2.4	24	25	75	0.252

Parts number	EHS	Nominal inductance [μH]	Inductance tolerance	Self-resonant frequency [MHz] (min.)	DC Resistance [Ω] (±30%)	Rated current ※) [mA]		Measuring frequency [MHz]
						Saturation current Idc1	Temperature rise current Idc2	
CB C2518T1R0M	RoHS	1.0	±20%	100	0.08	1,000	1,200	7.96
CB C2518T1R5M	RoHS	1.5	±20%	80	0.11	950	1,190	7.96
CB C2518T2R2M	RoHS	2.2	±20%	68	0.13	890	1,100	7.96
CB C2518T3R3M	RoHS	3.3	±20%	54	0.16	730	1,020	7.96
CB C2518T4R7M	RoHS	4.7	±20%	41	0.20	680	920	7.96
CB C2518T6R8M	RoHS	6.8	±20%	38	0.30	550	740	7.96
CB C2518T100□	RoHS	10	±10%, ±20%	30	0.36	480	680	2.52
CB C2518T150□	RoHS	15	±10%, ±20%	23	0.65	350	500	2.52
CB C2518T220□	RoHS	22	±10%, ±20%	19	0.77	320	460	2.52
CB C2518T330□	RoHS	33	±10%, ±20%	15	1.5	270	320	2.52
CB C2518T470□	RoHS	47	±10%, ±20%	12	1.9	240	290	2.52
CB C2518T680□	RoHS	68	±10%, ±20%	9.5	2.8	200	200	2.52
CB C2518T101□	RoHS	100	±10%, ±20%	9.0	3.7	160	170	0.796
CB C2518T151□	RoHS	150	±10%, ±20%	7.0	6.1	140	130	0.796
CB C2518T221□	RoHS	220	±10%, ±20%	5.5	8.4	115	110	0.796
CB C2518T331□	RoHS	330	±10%, ±20%	4.5	12.3	100	90	0.796
CB C2518T471□	RoHS	470	±10%, ±20%	3.5	22	80	70	0.796
CB C2518T681□	RoHS	680	±10%, ±20%	3.0	28	65	60	0.796

□ Please specify the Inductance tolerance code (Kor M)

※) The saturation current value (Idc1) is the DC current value having inductance decrease down to 30%. (at 20°C)

※) The temperature rise current value (Idc2) is the DC current value having temperature increase by 40°C. (at 20°C)

※) The rated current value is following either Idc1 or Idc2, which is the lower one.

3225 (1210) type

Parts number	EHS	Nominal inductance [μ H]	Inductance tolerance	Self-resonant frequency [MHz] (min.)	DC Resistance [Ω] ($\pm 30\%$)	Rated current ※) [mA]		Measuring frequency [MHz]
						Saturation current Idc1	Temperature rise current Idc2	
CB C3225T1R0MR	RoHS	1.0	$\pm 20\%$	250	0.055	2,000	1,440	0.1
CB C3225T1R5MR	RoHS	1.5	$\pm 20\%$	220	0.060	2,000	1,310	0.1
CB C3225T2R2MR	RoHS	2.2	$\pm 20\%$	190	0.080	2,000	1,130	0.1
CB C3225T3R3MR	RoHS	3.3	$\pm 20\%$	160	0.095	2,000	1,040	0.1
CB C3225T4R7MR	RoHS	4.7	$\pm 20\%$	70	0.100	1,250	1,010	0.1
CB C3225T6R8MR	RoHS	6.8	$\pm 20\%$	50	0.120	950	940	0.1
CB C3225T100□R	RoHS	10	$\pm 10\%$, $\pm 20\%$	23	0.133	900	900	0.1
CB C3225T150□R	RoHS	15	$\pm 10\%$, $\pm 20\%$	20	0.195	730	850	0.1
CB C3225T220□R	RoHS	22	$\pm 10\%$, $\pm 20\%$	17	0.27	620	780	0.1
CB C3225T330□R	RoHS	33	$\pm 10\%$, $\pm 20\%$	13	0.41	500	570	0.1
CB C3225T470□R	RoHS	47	$\pm 10\%$, $\pm 20\%$	10	0.67	390	480	0.1
CB C3225T680□R	RoHS	68	$\pm 10\%$, $\pm 20\%$	8.0	1.0	320	410	0.1
CB C3225T101□R	RoHS	100	$\pm 10\%$, $\pm 20\%$	6.0	1.4	270	340	0.1
CB C3225T221□R	RoHS	220	$\pm 10\%$, $\pm 20\%$	3.0	2.5	190	190	0.1
CB C3225T821□R	RoHS	820	$\pm 10\%$, $\pm 20\%$	1.8	12	110	110	0.1
CB C3225T102□R	RoHS	1000	$\pm 10\%$, $\pm 20\%$	1.6	13	100	100	0.1

□ Please specify the Inductance tolerance code (Kor M)

- ※) The saturation current value (Idc1) is the DC current value having inductance decrease down to 30%. (at 20°C)
 ※) The temperature rise current value (Idc2) is the DC current value having temperature increase by 40°C. (at 20°C)
 ※) The rated current value is following either Idc1 or Idc2, which is the lower one.

WIRE-WOUND CHIP INDUCTORS (LB SERIES), WIRE-WOUND CHIP POWER INDUCTORS (CB SERIES), WIRE-WOUND CHIP INDUCTORS FOR SIGNAL LINES (LB SERIES M TYPE)

PACKAGING

① Minimum Quantity

Type	Standard Quantity [pcs]	
	Paper Tape	Embossed Tape
LB C3225	—	1000
CB C3225	—	1000
LB 3218	—	2000
LB R2518	—	2000
LB C2518	—	2000
LB 2518	—	2000
CB 2518	—	2000
CB C2518	—	2000
LBM2016	—	2000
LB C2016	—	2000
LB 2016	—	2000
CB 2016	—	2000
CB C2016	—	2000
LB 2012	—	3000
LB C2012	—	3000
LB R2012	—	3000
CB 2012	—	3000
CB C2012	—	3000
CB L2012	4000	—
LB 1608	4000	—
LBMF1608	—	3000
CBMF1608	—	3000

② Tape material

● Embossed tape

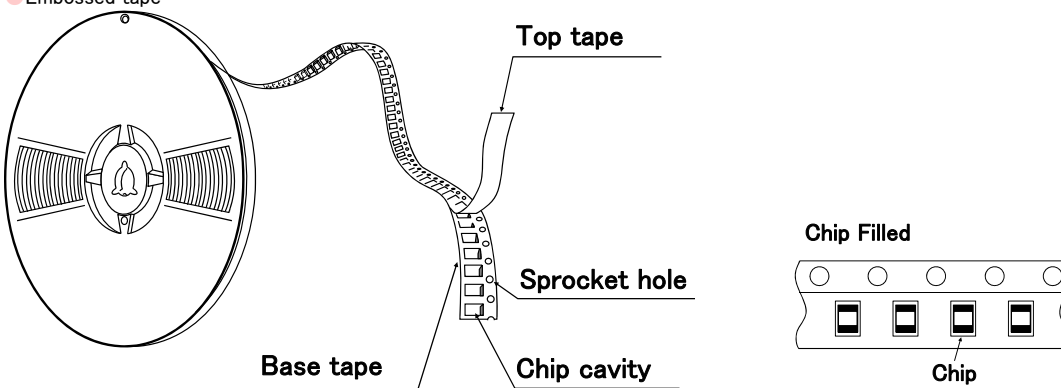

● Card board carrier tape



▶ This catalog contains the typical specification only due to the limitation of space. When you consider the purchase of our products, please check our specification. For details of each product (characteristics graph, reliability information, precautions for use, and so on), see our Web site (<http://www.ty-top.com/>).

③ Taping Dimensions

● Embossed Tape (0.315 inches wide)



Type	Chip cavity		Insertion pitch	Tape thickness	
	A	B	F	T	K
LBM2016	1.75 ± 0.1 (0.069 ± 0.004)	2.1 ± 0.1 (0.083 ± 0.004)	4.0 ± 0.1 (0.157 ± 0.004)	0.3 ± 0.05 (0.012 ± 0.002)	1.9max. (0.075max.)
LB C3225 CB C3225	2.8 ± 0.1 (0.110 ± 0.004)	3.5 ± 0.1 (0.138 ± 0.004)	4.0 ± 0.1 (0.157 ± 0.004)	0.3 ± 0.05 (0.012 ± 0.002)	4.0max. (0.157max.)
LB 3218	2.1 ± 0.1 (0.083 ± 0.004)	3.5 ± 0.1 (0.138 ± 0.004)	4.0 ± 0.1 (0.157 ± 0.004)	0.3 ± 0.05 (0.012 ± 0.002)	2.2max. (0.087max.)
LB 2518 CB 2518 LB C2518 CB C2518 LB R2518	2.15 ± 0.1 (0.085 ± 0.004)	2.7 ± 0.1 (0.106 ± 0.004)	4.0 ± 0.1 (0.157 ± 0.004)	0.3 ± 0.05 (0.012 ± 0.002)	2.2max. (0.087max.)
LB 2016 CB 2016 LB C2016 CB C2016	1.75 ± 0.1 (0.069 ± 0.004)	2.1 ± 0.1 (0.083 ± 0.004)	4.0 ± 0.1 (0.157 ± 0.004)	0.3 ± 0.05 (0.012 ± 0.002)	1.9max. (0.075max.)
LB 2012 CB 2012 LB C2012 CB C2012 LB R2012	1.45 ± 0.1 (0.057 ± 0.004)	2.25 ± 0.1 (0.089 ± 0.004)	4.0 ± 0.1 (0.157 ± 0.004)	0.25 ± 0.05 (0.010 ± 0.002)	1.45max. (0.057max.)
LBMF1608 CBMF1608	1.1 ± 0.1 (0.043 ± 0.004)	1.9 ± 0.1 (0.075 ± 0.004)	4.0 ± 0.1 (0.157 ± 0.004)	0.25 ± 0.05 (0.010 ± 0.002)	1.2max. (0.047max.)

Unit: mm (inch)

● Card board carrier tape (0.315 inches wide)

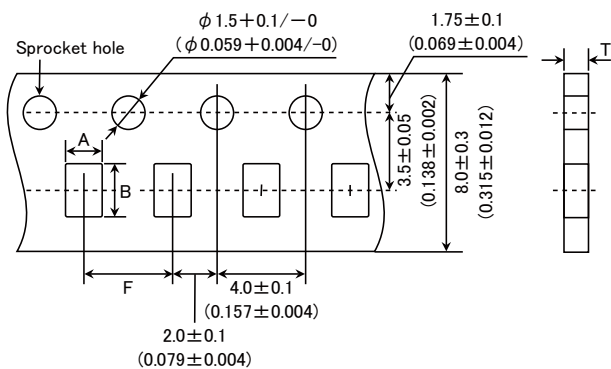

Type	Chip cavity		Insertion pitch	Tape thickness
	A	B	F	T
CB L2012	1.55 ± 0.1 (0.061 ± 0.004)	2.3 ± 0.1 (0.091 ± 0.004)	4.0 ± 0.1 (0.157 ± 0.004)	1.1max. (0.043max.)
LB 1608	1.0 ± 0.1 (0.039 ± 0.004)	1.8 ± 0.1 (0.071 ± 0.004)	4.0 ± 0.1 (0.157 ± 0.004)	1.1max. (0.043max.)

Unit: mm (inch)

④ Leader and Blank Portion

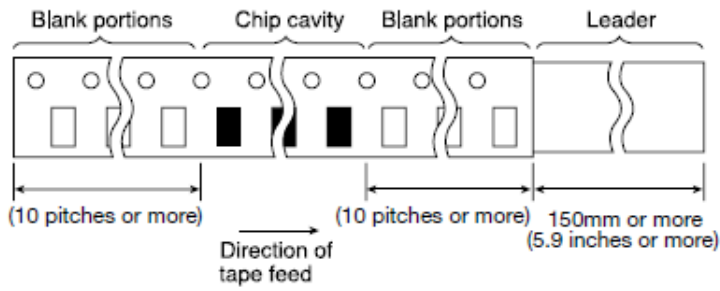

⑤ Reel Size

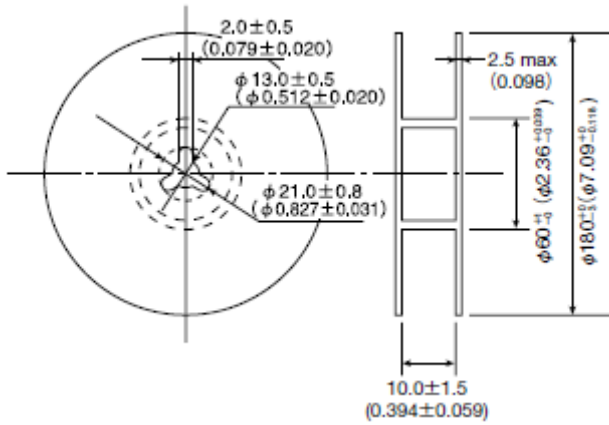

⑥ Top Tape Strength

The top tape requires a peel-off force 0.2 to 0.7N in the direction of the arrow as illustrated below.

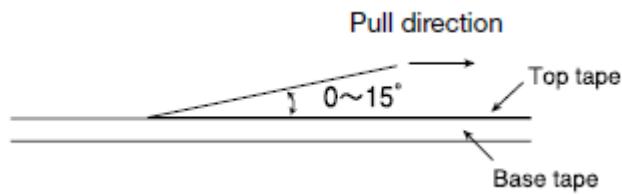

WIRE-WOUND CHIP INDUCTORS (LB SERIES), WIRE-WOUND CHIP POWER INDUCTORS (CB SERIES), WIRE-WOUND CHIP INDUCTORS FOR SIGNAL LINES (LB SERIES M TYPE)

RELIABILITY DATA

1. Operating temperature Range		
Specified Value	LB, LBC, LBR, LBMF Series	-40~ +105°C (Including self-generated heat)
	CB, CBC, CBL, CBMF Series	
	LBM Series	
2. Storage Temperature Range (after soldering)		
Specified Value	LB, LBC, LBR, LBMF Series	-40~ +85°C
	CB, CBC, CBL, CBMF Series	
	LBM Series	
Test Methods and Remarks	LB, CB Series : Please refer the term of "7. storage conditions" in precautions.	
3. Rated Current		
Specified Value	LB, LBC, LBR, LBMF Series	Within the specified tolerance
	CB, CBC, CBL, CBMF Series	
	LBM Series	
4. Inductance		
Specified Value	LB, LBC, LBR, LBMF Series	Within the specified tolerance
	CB, CBC, CBL, CBMF Series	
	LBM Series	
Test Methods and Remarks	LB・LBC・LBR・CB・CBC・CBL・LBMF・CBMF・LBM Series Measuring equipment : LCR Meter (HP4285A or its equivalent) Measuring frequency : Specified frequency	
5. Q		
Specified Value	LB, LBC, LBR, LBMF Series	-
	CB, CBC, CBL, CBMF Series	
	LBM Series	
Test Methods and Remarks	LBM Series Measuring equipment : LCR Meter (HP4285A or its equivalent) Measuring frequency : Specified frequency	
6. DC Resitance		
Specified Value	LB, LBC, LBR, LBMF Series	Within the specified tolerance
	CB, CBC, CBL, CBMF Series	
	LBM Series	
Test Methods and Remarks	Measuring equipment : DC Ohmmeter (HIOKI 3227 or its equivalent)	
7. Self-Resonant Frequency		
Specified Value	LB, LBC, LBR, LBMF Series	Within the specified tolerance
	CB, CBC, CBL, CBMF Series	
	LBM Series	
Test Methods and Remarks	Measuring equipment : Impedance analyzer (HP4291A or its equivalent)	

▶ This catalog contains the typical specification only due to the limitation of space. When you consider the purchase of our products, please check our specification.
For details of each product (characteristics graph, reliability information, precautions for use, and so on), see our Web site (<http://www.ty-top.com/>).

8. Temperature Characteristic					
Specified Value	LBM2016				Inductance change : Within $\pm 5\%$
	LB1608	LB2012	LBR2012	CB2012	Inductance change : Within $\pm 20\%$
	CBL2012	LB2016	CB2016	LB2518	
	LBR2518	CB2518	LBC3225	CBC3225	
	LBMF1608	CBMF1608	LBC2016	CBC2016	Inductance change : Within $\pm 25\%$
LBC2518	CBC2518	LB3218			
Test Methods and Remarks	LBC2012	CBC2012			Inductance change : Within $\pm 35\%$
	Based on the inductance at 20°C and Measured at the ambient of $-40^{\circ}\text{C} \sim +85^{\circ}\text{C}$.				

9. Resistance to Flexure of Substrate			
Specified Value	LB, LBC, LBR, LBMF Series		No damage.
	CB, CBC, CBL, CBMF Series		
	LBM Series		
Test Methods and Remarks	Warp : 2mm (LB·LBC·LBR·CB·CBC·CBL·LBM·LBMF·CBMF Series)		
	Test substrate : Glass epoxy-resin substrate Thickness : 0.8mm (LB1608·LBMF1608·CBMF1608) : 1.0mm (Others)		

10. Body Strength			
Specified Value	LB, LBC, LBR, LBMF Series		No damage.
	CB, CBC, CBL, CBMF Series		
	LBM Series		
Test Methods and Remarks	LB·LBC·LBR·CB·CBC·CBL·LBM		
	Applied force : 10N Duration : 10sec. LB1608·LBMF1608·CBMF1608 Applied force : 5N Duration : 10sec.		

11. Adhesion of terminal electrode			
Specified Value	LB, LBC, LBR, LBMF Series		No abnormality.
	CB, CBC, CBL, CBMF Series		
	LBM Series		
Test Methods and Remarks	LB·LBC·LBR·CB·CBC·CBL·LBM·LBMF·CBMF		
	Applied force : 10N to X and Y directions Duration : 5 sec. Test substrate : Printed board LB1608·CBMF1608·LBMF1608 Applied force : 5N to X and Y directions Duration : 5 sec. Test substrate : Printed board		

▶ This catalog contains the typical specification only due to the limitation of space. When you consider the purchase of our products, please check our specification.
 For details of each product (characteristics graph, reliability information, precautions for use, and so on), see our Web site (<http://www.ty-top.com/>).

12. Resistance to vibration		
Specified Value	LB, LBC, LBR, LBMF Series	Inductance change : Within $\pm 10\%$ No significant abnormality in appearance.
	CB, CBC, CBL, CBMF Series	
	LBM Series	Inductance change : Within $\pm 5\%$ No significant abnormality in appearance.
Test Methods and Remarks	LB·LBR·LBC·CB·CBC·CBL·LBM·LBMF·CBMF : The given sample is soldered to the board and then it is tested depending on the conditions of the following table.	
	Vibration Frequency	10~55Hz
	Total Amplitude	1.5mm (May not exceed acceleration 196m/s ²)
	Sweeping Method	10Hz to 55Hz to 10Hz for 1min.
Time	X	For 2 hours on each X, Y, and Z axis.
	Y	
	Z	
Recovery	: At least 2 hrs of recovery under the standard condition after the test, followed by the measurement within 48 hrs.	

13. Drop test		
Specified Value	LB, LBC, LBR, LBMF Series	—
	CB, CBC, CBL, CBMF Series	
	LBM Series	

14. Solderability		
Specified Value	LB, LBC, LBR, LBMF Series	At least 90% of surface of terminal electrode is covered by new
	CB, CBC, CBL, CBMF Series	
	LBM Series	
Test Methods and Remarks	LB·LBC·LBR·CB·CBC·CBL·LBM·LBMF·CBMF : Solder temperature : 245 \pm 5 $^{\circ}$ C Duration : 5 \pm 0.5sec Flux : Methanol solution with 25% of colophony	

15. Resistance to soldering		
Specified Value	LB, LBC, LBR, LBMF Series	Inductance change : Within $\pm 10\%$
	CB, CBC, CBL, CBMF Series	
	LBM Series	Inductance change : Within $\pm 5\%$
Test Methods and Remarks	LB·LBC·LBR·CB·CBC·CBL·LBM·LBMF·CBMF : 3 times of reflow oven at 230 $^{\circ}$ C MIN for 40sec. with peak temperature at 260 $^{\circ}$ C for 5sec. Recovery : At least 2 hrs of recovery under the standard condition after the test, followed by the measurement within 48 hrs.	

16. Resistance to solvent		
Specified Value	LB, LBC, LBR, LBMF Series	—
	CB, CBC, CBL, CBMF Series	
	LBM Series	
Test Methods and Remarks	Solvent temperature : Room temperature Type of solvent : Isopropyl alcohol Cleaning conditions : 90s. Immersion and cleaning.	

17. Thermal shock			
Specified Value	LB, LBC, LBR, LBMF Series	Inductance change : Within $\pm 10\%$ No significant abnormality in appearance.	
	CB, CBC, CBL, CBMF Series		
	LBM Series		
Test Methods and Remarks	LB·LBC·LBR·CB·CBC·CBL·LBM·LBMF·CBMF : The given sample is soldered to the board and then its Inductance is measured after 100cycles of the following conditions.		
	Conditions of 1 cycle		
	Step	Temperature ($^{\circ}$ C)	Duration (min)
	1	-40 \pm 3	30 \pm 3
	2	Room temperature	Within 3
	3	+85 \pm 2	30 \pm 3
4	Room temperature	Within 3	
Recovery	: At least 2 hrs of recovery under the standard condition after the test, followed by the measurement within 48 hrs.		

▶ This catalog contains the typical specification only due to the limitation of space. When you consider the purchase of our products, please check our specification.
For details of each product (characteristics graph, reliability information, precautions for use, and so on), see our Web site (<http://www.ty-top.com/>).

18.Damp heat life test		
Specified Value	LB, LBC, LBR, LBMF Series	Inductance change : Within $\pm 10\%$ No significant abnormality in appearance.
	CB, CBC, CBL, CBMF Series	
	LBM Series	
Test Methods and Remarks	Temperature : $60 \pm 2^\circ\text{C}$ Humidity : $90 \sim 95\% \text{RH}$ Duration : 1000 hrs Recovery : At least 2 hrs of recovery under the standard condition after the test, followed by the measurement within 48 hrs.	

19.Loading under damp heat life test		
Specified Value	LB, LBC, LBR, LBMF Series	Inductance change : Within $\pm 10\%$ No significant abnormality in appearance.
	CB, CBC, CBL, CBMF Series	
	LBM Series	
Test Methods and Remarks	Temperature : $60 \pm 2^\circ\text{C}$ Humidity : $90 \sim 95\% \text{RH}$ Duration : 1000 hrs Applied current : Rated current Recovery : At least 2 hrs of recovery under the standard condition after the test, followed by the measurement within 48 hrs.	

20.High temperature life test		
Specified Value	LB, LBC, LBR, LBMF Series	—
	CB, CBC, CBL, CBMF Series	Inductance change : Within $\pm 10\%$ No significant abnormality in appearance.
	LBM Series	
Test Methods and Remarks	Temperature : $85 \pm 2^\circ\text{C}$ Duration : 1000 hrs Recovery : At least 2 hrs of recovery under the standard condition after the test, followed by the measurement within 48 hrs.	

21.Loading at high temperature life test		
Specified Value	LB, LBC, LBR, LBMF Series	Inductance change : Within $\pm 10\%$ (LBC3225 Series : Within $\pm 20\%$) No significant abnormality in appearance.
	CB, CBC, CBL, CBMF Series	
	LBM Series	—
Test Methods and Remarks	Temperature : $85 \pm 2^\circ\text{C}$ Duration : 1000 hrs Applied current : Rated current Recovery : At least 2 hrs of recovery under the standard condition after the test, followed by the measurement within 48 hrs.	

22.Low temperature life test		
Specified Value	LB, LBC, LBR, LBMF Series	Inductance change : Within $\pm 10\%$ No significant abnormality in appearance.
	CB, CBC, CBL, CBMF Series	
	LBM Series	
Test Methods and Remarks	Temperature : $-40 \pm 2^\circ\text{C}$ Duration : 1000 hrs Recovery : At least 2 hrs of recovery under the standard condition after the test, followed by the measurement within 48 hrs.	

23.Standard condition		
Specified Value	LB, LBC, LBR, LBMF Series	Standard test conditions Unless specified, Ambient temperature is $20 \pm 15^\circ\text{C}$ and the Relative humidity is $65 \pm 20\%$. If there is any doubt about the test results, further measurement shall be had within the following limits: Ambient Temperature: $20 \pm 2^\circ\text{C}$ Relative humidity: $65 \pm 5\%$ Inductance value is based on our standard measurement systems.
	CB, CBC, CBL, CBMF Series	
	LBM Series	

▶ This catalog contains the typical specification only due to the limitation of space. When you consider the purchase of our products, please check our specification.
For details of each product (characteristics graph, reliability information, precautions for use, and so on), see our Web site (<http://www.ty-top.com/>).

WIRE-WOUND CHIP INDUCTORS (LB SERIES), WIRE-WOUND CHIP POWER INDUCTORS (CB SERIES), WIRE-WOUND CHIP INDUCTORS FOR SIGNAL LINES (LB SERIES M TYPE)

■ PRECAUTIONS

1. Circuit Design	
Precautions	<p>◆Operating environment</p> <p>1. The products described in this specification are intended for use in general electronic equipment, (office supply equipment, telecommunications systems, measuring equipment, and household equipment). They are not intended for use in mission-critical equipment or systems requiring special quality and high reliability (traffic systems, safety equipment, aerospace systems, nuclear control systems and medical equipment including life-support systems,) where product failure might result in loss of life, injury or damage. For such uses, contact TAIYO YUDEN Sales Department in advance.</p>
2. PCB Design	
Precautions	<p>◆Land pattern design</p> <p>1. Please contact any of our offices for a land pattern, and refer to a recommended land pattern of a right figure or specifications.</p>
Technical considerations	<p>PRECAUTIONS 【Recommended Land Patterns】</p> <p>Surface Mounting</p> <ul style="list-style-type: none"> • Mounting and soldering conditions should be checked beforehand. • Applicable soldering process to those products is reflow soldering only.
3. Considerations for automatic placement	
Precautions	<p>◆Adjustment of mounting machine</p> <p>1. Excessive impact load should not be imposed on the products when mounting onto the PC boards.</p> <p>2. Mounting and soldering conditions should be checked beforehand.</p>
Technical considerations	<p>1. When installing products, care should be taken not to apply distortion stress as it may deform the products.</p>
4. Soldering	
Precautions	<p>◆Reflow soldering(LB and CB Types)</p> <p>1. For reflow soldering with either leaded or lead-free solder, the profile specified in "point for controlling" is recommended.</p> <p>◆Recommended conditions for using a soldering iron</p> <p>1. Put the soldering iron on the land-pattern. Soldering iron's temperature - Below 350°C Duration-3 seconds or less. The soldering iron should not come in contact with inductor directly.</p>
Technical considerations	<p>◆Reflow soldering(LB and CB Types)</p> <p>1. Reflow profile</p> <p>Temperature [°C]</p> <p>Heating Time [sec]</p> <p>150~180</p> <p>90±30sec</p> <p>30±10sec</p> <p>230°C min</p> <p>5sec max</p> <p>Peak: 260+0/-5°C</p> <p>◆Recommended conditions for using a soldering iron</p> <p>1. Components can be damaged by excessive heat where soldering conditions exceed the specified range.</p>
5. Cleaning	
Precautions	<p>◆Cleaning conditions</p> <p>Washing by supersonic waves shall be avoided.</p>
Technical considerations	<p>◆Cleaning conditions</p> <p>If washed by supersonic waves, the products might be broken.</p>

6. Handling	
Precautions	<ul style="list-style-type: none"> ◆ Handling <ol style="list-style-type: none"> 1. Keep the inductors away from all magnets and magnetic objects. ◆ Breakaway PC boards (splitting along perforations) <ol style="list-style-type: none"> 1. When splitting the PC board after mounting inductors, care should be taken not to give any stresses of deflection or twisting to the board. 2. Board separation should not be done manually, but by using the appropriate devices. ◆ Mechanical considerations <ol style="list-style-type: none"> 1. Please do not give the inductors any excessive mechanical shocks.
Technical considerations	<ul style="list-style-type: none"> ◆ Handling <ol style="list-style-type: none"> 1. There is a case that a characteristic varies with magnetic influence. ◆ Breakaway PC boards (splitting along perforations) <ol style="list-style-type: none"> 1. Planning pattern configurations and the position of products should be carefully performed to minimize stress. ◆ Mechanical considerations <ol style="list-style-type: none"> 1. There is a case to be damaged by a mechanical shock.

7. Storage conditions	
Precautions	<ul style="list-style-type: none"> ◆ Storage <ol style="list-style-type: none"> 1. To maintain the solderability of terminal electrodes and to keep the packing material in good condition, temperature and humidity in the storage area should be controlled. <ul style="list-style-type: none"> • Recommended conditions <ul style="list-style-type: none"> Ambient temperature : 0~40°C Humidity : Below 70% RH • The ambient temperature must be kept below 30°C. Even under ideal storage conditions, solderability of products electrodes may decrease as time passes. <ul style="list-style-type: none"> For this reason, product should be used within 6 months from the time of delivery. In case of storage over 6 months, solderability shall be checked before actual usage.
Technical considerations	<ul style="list-style-type: none"> ◆ Storage <ol style="list-style-type: none"> 1. Under a high temperature and humidity environment, problems such as reduced solderability caused by oxidation of terminal electrodes and deterioration of taping/packaging materials may take place.

Данный компонент на территории Российской Федерации

Вы можете приобрести в компании MosChip.

Для оперативного оформления запроса Вам необходимо перейти по данной ссылке:

<http://moschip.ru/get-element>

Вы можете разместить у нас заказ для любого Вашего проекта, будь то серийное производство или разработка единичного прибора.

В нашем ассортименте представлены ведущие мировые производители активных и пассивных электронных компонентов.

Нашей специализацией является поставка электронной компонентной базы двойного назначения, продукции таких производителей как XILINX, Intel (ex.ALTERA), Vicor, Microchip, Texas Instruments, Analog Devices, Mini-Circuits, Amphenol, Glenair.

Сотрудничество с глобальными дистрибьюторами электронных компонентов, предоставляет возможность заказывать и получать с международных складов практически любой перечень компонентов в оптимальные для Вас сроки.

На всех этапах разработки и производства наши партнеры могут получить квалифицированную поддержку опытных инженеров.

Система менеджмента качества компании отвечает требованиям в соответствии с ГОСТ Р ИСО 9001, ГОСТ РВ 0015-002 и ЭС РД 009

Офис по работе с юридическими лицами:

105318, г.Москва, ул.Щербаковская д.3, офис 1107, 1118, ДЦ «Щербаковский»

Телефон: +7 495 668-12-70 (многоканальный)

Факс: +7 495 668-12-70 (доб.304)

E-mail: info@moschip.ru

Skype отдела продаж:

moschip.ru

moschip.ru_4

moschip.ru_6

moschip.ru_9