

**Variable Transformers
Series 6000 • 35.0 to 315.0 Amperes**

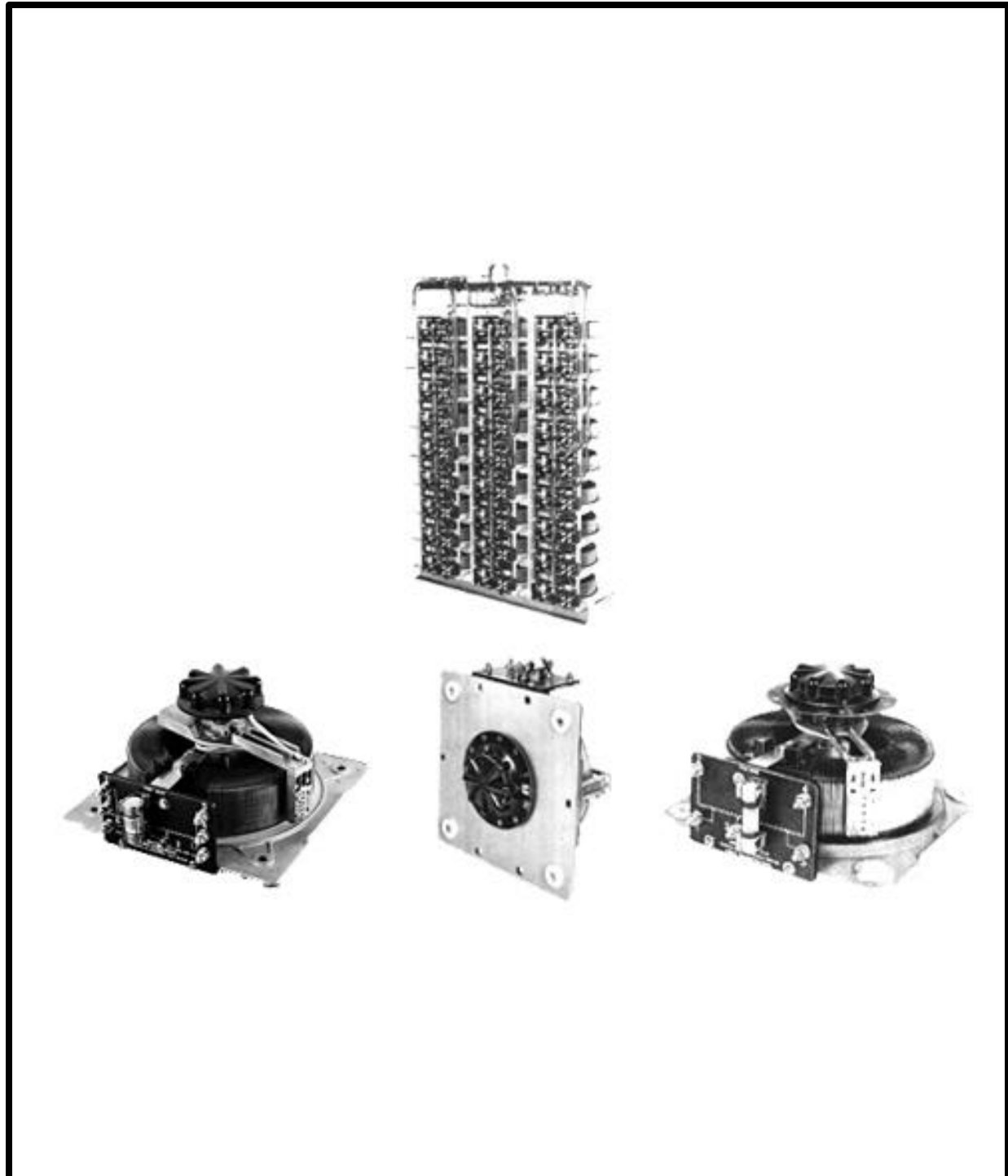

5000/6000 Series



Manual Single, Uncased



Manual Single, Cased



Manual Two-Ganged, Cased

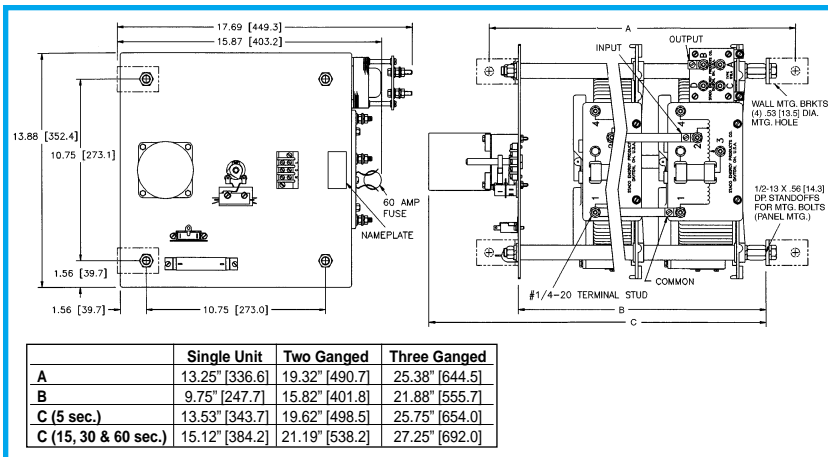

	Single Unit	Two Ganged	Three Ganged
A	13.25" [336.6]	19.32" [490.7]	25.38" [644.5]
B	9.75" [247.7]	15.82" [401.8]	21.88" [555.7]
C (5 sec.)	13.53" [343.7]	19.62" [498.5]	25.75" [654.0]
C (15, 30 & 60 sec.)	15.12" [384.2]	21.19" [538.2]	27.25" [692.0]

Motor Driven, Single, Two and Three-Ganged, Uncased



Manual Two and Three-Ganged, Uncased

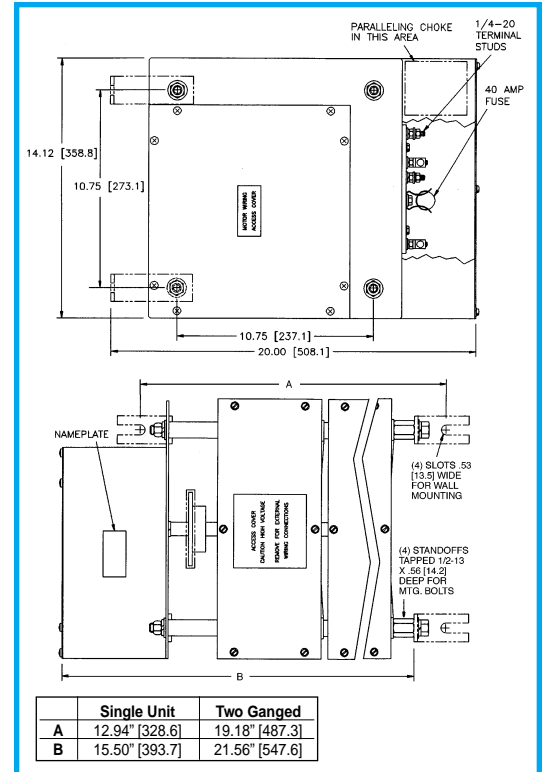

Motor Driven, Single and Two-Ganged, Cased

5000/6000 Series



Manual Three to Nine-Ganged, Cased



Motor-Driven Three to Nine-Ganged, Cased



Motor-Driven 10, 12, 14, 16 & 18-Ganged Open Delta and Parallel, Cased



Manual Four to Nine-Ganged, Uncased



5021-3Y

5000/6000 Series

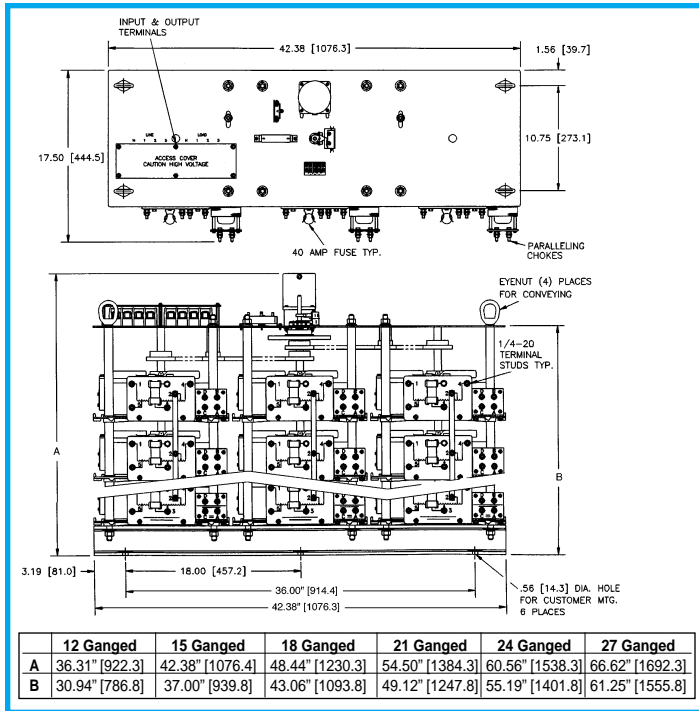

Motor-Driven 12, 15, 18, 21, 24 & 27-Ganged, Uncased

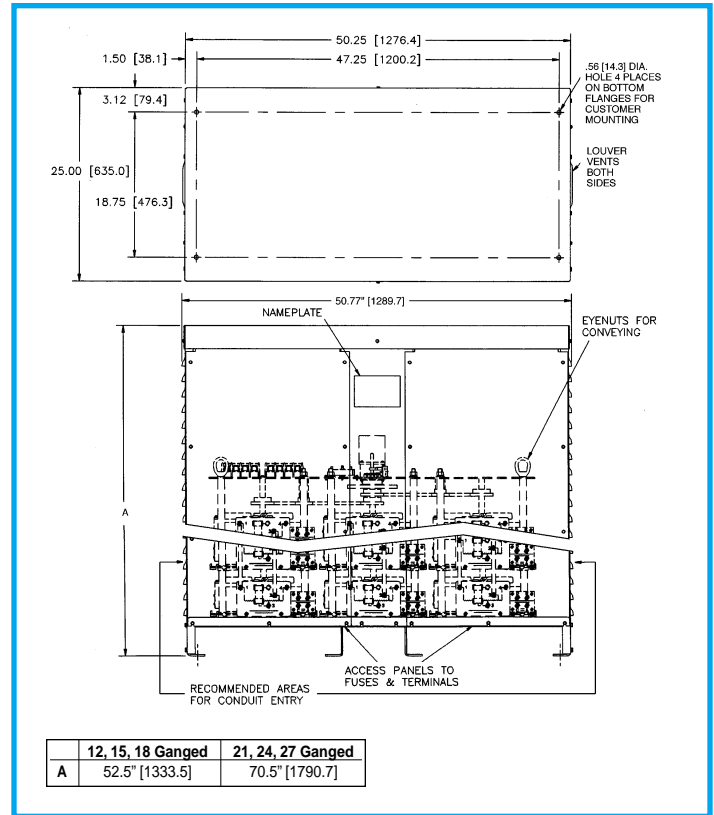

Motor-Driven 12, 15, 18, 21, 24 & 27-Ganged, Cased

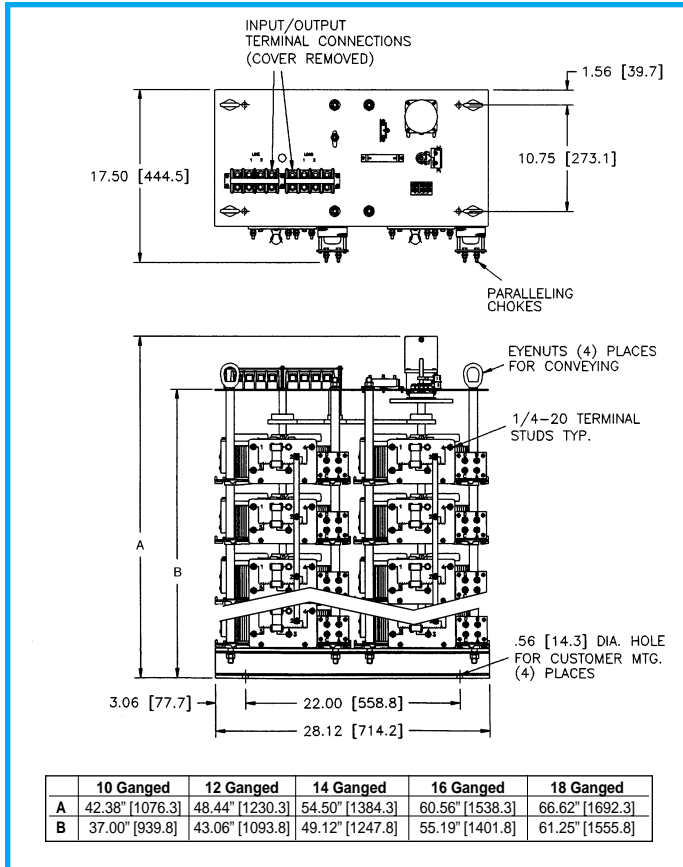

Motor-Driven 10, 12, 14, 16 & 18-Ganged Open Delta & Parallel, Uncased

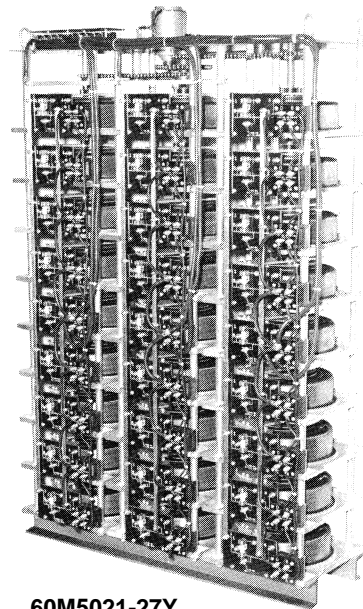

60M5021-27Y

6000 Series

Variable transformers of the 6011/6020 Series are designed for larger KVA requirements. The 6011, 120 volt unit is rated for constant current of 60 amperes. The 6020, 240 volt unit is rated at 35 amperes for constant current loads. All single units have coil tapping arrangements allowing output voltage from 0 to line voltage or 17% above line voltage.

Adjustable shaft design on manually operated models permits back-of-panel or bench mounting. Terminals are 1/4" screw type. For single and two ganged units, case styles are available in either "C" style, which encloses only the coil, or the "CT" style, which provides protective housing for both the coil and terminal board. Knockouts are provided in the terminal board

housing to accommodate conduit or cable connections. For three ganged and above, we offer our Nema 1, dripproof, fully front accessible "E" enclosure.

Motor-driven models are available from single thru 27 ganged assemblies; cased or uncased (identified with the prefix "M" in the part number). The synchronous motor is designed for operation on 120 volt, 50/60 Hertz lines and draws approximately 0.3 amperes. To meet a wide range of application requirements, standard motor speeds of 5, 15, 30 and 60 seconds are available depending upon the size of the variable transformer.

PART NUMBER		WIRING	INPUT		OUTPUT			SHAFT ROTATION FOR VOLTAGE INCREASE	TERMINAL CONNECTIONS For Increasing Voltage As Viewed from Rotor End		SCHEMATIC (Pg 8 & 9)	NET WEIGHT IN LBS. (MAX)			
MANUALLY OPERATED	MOTOR DRIVEN		VOLTS	HERTZ	VOLTS	MAX AMPS	MAX KVA		INPUT	OUTPUT		MAN-UAL	MOTOR DRIVEN		
6011 6011C 6011CT	M6011 M6011C M6011CT	Single Phase	120	50/60	0-120	60	7.2	CW	2-4	2-3	19	67	88		
								CCW	4-2	4-3					
					0-140	60	8.4	CW	2-5	2-3					
								CCW	4-1	4-3					
6020 6020C 6020CT	M6020 M6020C M6020CT	Single Phase	240	50/60	0-240	35	8.4	CW	2-4	2-3	19	63	84		
								CCW	4-2	4-3					
					0-280	35	9.8	CW	2-5	2-3					
								CCW	4-1	4-3					
					120	50/60	0-280	35*-15 V.D.	4.2‡	CW				2-6	2-3
										CCW				4-7	4-3
6011-2D 6011C-2D 6011CT-2D	M6011-2D M6011C-2D M6011CT-2D	Three Phase Open Delta	120	50/60	0-120	60	12.5	CW	4-1-4	3-1-3	20 & 5	154	175		
					0-140	60	14.5	CW	2-1-2	3-1-3					
6011-2P 6011C-2P 6011CT-2P	M6011-2P M6011C-2P M6011CT-2P	Single Phase Parallel	120	50/60	0-120	120	14.4	CW	1-4	1-B	21	156	177		
					0-140	120	16.8	CW	1-2	1-B					
6011-2S 6011C-2S 6011CT-2S	M6011-2S M6011C-2S M6011CT-2S	Single Phase Series	240	50/60	0-240	60	14.4	CW	4-4	3-3	20 & 4	154	175		
					0-280	60	16.8	CW	2-2	3-3					
6020-2D 6020C-2D 6020CT-2D	M6020-2D M6020C-2D M6020CT-2D	Three Phase Open Delta	240	50/60	0-240	35	14.5	CW	4-1-4	3-1-3	20 & 5	146	167		
					0-280	35	16.9	CW	2-1-2	3-1-3					
6020-2P 6020C-2P 6020CT-2P	M6020-2P M6020C-2P M6020CT-2P	Single Phase Parallel	240	50/60	0-240	70	16.8	CW	1-4	1-B	21	148	169		
					0-280	70	19.6	CW	1-2	1-B					
6020-2S 6020C-2S 6020CT-2S	M6020-2S M6020C-2S M6020CT-2S	Single Phase Series	480	50/60	0-480	35	16.8	CW	4-4	3-3	20 & 4	146	167		
					0-560	35	19.6	CW	2-2	3-3					
6011-3P 6011E-3P	M6011-3P M6011E-3P	Single Phase Parallel	120	50/60	0-120	180	21.6	CW	1-4	1-D	22	246	267		
					0-140	180	25.2	CW	1-2	1-D					
6011-3Y 6011E-3Y	M6011-3Y M6011E-3Y	Three Phase Wye	240	60	0-240	60	24.9	CW	4-4-4	3-3-3	20 & 6	242	263		
					0-280	60	29.1	CW	2-2-2	3-3-3					



6011

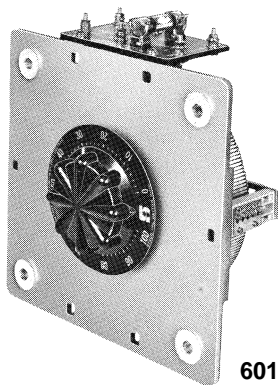

6011

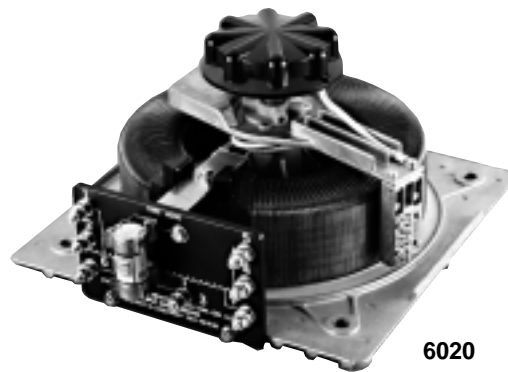

6020

6000 Series



PART NUMBER		WIRING	INPUT		OUTPUT			SHAFT ROTATION FOR VOLTAGE INCREASE	TERMINAL CONNECTIONS For Increasing Voltage As Viewed from Rotor End		SCHEMATIC (Pg 8 & 9)	NET WEIGHT IN LBS. (MAX)	
MANUALLY OPERATED	MOTOR DRIVEN		VOLTS	HERTZ	VOLTS	MAX AMPS	MAX KVA		INPUT	OUTPUT		MANUAL	MOTOR DRIVEN
6020-3P 6020E-3P	M6020-3P M6020E-3P	Single Phase Parallel	240	50/60	0-240	105	25.2	CW	1-4	1-D	22	246	267
					0-280	105	29.4	CW	1-2	1-D			
			120	50/60	0-280	105*-45 V.D.	12.6‡	CW	1-5	1-D			
6020-3Y 6020E-3Y	M6020-3Y M6020E-3Y	Three Phase Wye	480	50/60	0-480	35	29.1	CW	4-4-4	3-3-3	20 & 6	240	261
				60	0-560	35	33.9	CW	2-2-2	3-3-3			
			240	60	0-560	35*-15 V.D.	14.5‡	CW	5-5-5	3-3-3			
6011-4D 6011E-4D	M6011-4D M6011E-4D	Three Phase Open Delta	120	50/60	0-120	120	24.9	CW	4-1-4	B-1-B	21 & 5	354	375
					0-140	120	29.1	CW	2-1-2	B-1-B			
			120	50/60	0-140	120	33.6	CW	1-2	1-D			
6011-4P 6011E-4P	M6011-4P M6011E-4P	Single Phase Parallel	120	50/60	0-120	240	28.8	CW	1-4	1-D	22	356	377
					0-140	240	33.6	CW	1-2	1-D			
			240	50/60	0-240	120	28.8	CW	4-4	B-B			
			240	50/60	0-280	120	33.6	CW	2-2	B-B			
6011-4PS 6011E-4PS	M6011-4PS M6011E-4PS	Single Phase Series Parallel	240	50/60	0-240	120	28.8	CW	4-4	B-B	21 & 4	354	375
					0-280	120	33.6	CW	2-2	B-B			
			240	50/60	0-240	70	29.1	CW	4-1-4	B-1-B			
			240	50/60	0-280	70	33.9	CW	2-1-2	B-1-B			
6020-4D 6020E-4D	M6020-4D M6020E-4D	Three Phase Open Delta	240	50/60	0-240	70	29.1	CW	4-1-4	B-1-B	21 & 5	338	359
					0-280	70	33.9	CW	2-1-2	B-1-B			
			120	50/60	0-280	70*-30 V.D.	14.5‡	CW	5-1-5	B-1-B			
6020-4P 6020E-4P	M6020-4P M6020E-4P	Single Phase Parallel	240	50/60	0-240	140	33.6	CW	1-4	1-D	22	340	361
					0-280	140	39.2	CW	1-2	1-D			
			120	50/60	0-280	140*-60 V.D.	16.8‡	CW	1-5	1-D			
6020-4PS 6020E-4PS	M6020-4PS M6020E-4PS	Single Phase Series Parallel	480	50/60	0-480	70	33.6	CW	4-4	B-B	21 & 4	338	359
					0-560	70	39.2	CW	2-2	B-B			
			240	50/60	0-560	70*-30 V.D.	16.8‡	CW	5-5	B-B			
6011-5P 6011E-5P	M6011-5P M6011E-5P	Single Phase Parallel	120	50/60	0-120	300	36.0	CW	1-4	1-D	22	450	471
					0-140	300	42.0	CW	1-2	1-D			
			240	50/60	0-240	175	42.0	CW	1-4	1-D			
			240	50/60	0-280	175	49.0	CW	1-2	1-D			
6020-5P 6020E-5P	M6020-5P M6020E-5P	Single Phase Parallel	120	50/60	0-280	175*-75 V.D.	21.0‡	CW	1-5	1-D	22	430	451
6011-6D 6011E-6D	M6011-6D M6011E-6D	Three Phase Open Delta	120	50/60	0-120	180	37.4	CW	4-1-4	D-1-D	22 & 5	541	562
					0-140	180	43.6	CW	2-1-2	D-1-D			
			120	50/60	0-140	180	50.4	CW	1-2	1-D			
6011-6P 6011E-6P	M6011-6P M6011E-6P	Single Phase Parallel	120	50/60	0-120	360	43.2	CW	1-4	1-D	22	543	564
					0-140	360	50.4	CW	1-2	1-D			
			240	50/60	0-240	180	43.2	CW	4-4	D-D			
			240	50/60	0-280	180	50.4	CW	2-2	D-D			
6011-6PS 6011E-6PS	M6011-6PS M6011E-6PS	Single Phase Series Parallel	240	50/60	0-240	180	43.2	CW	4-4	D-D	22 & 4	541	562
					0-280	180	50.4	CW	2-2	D-D			
6011-6Y 6011E-6Y	M6011-6Y M6011E-6Y	Three Phase Wye	240	60	0-240	120	49.8	CW	4-4-4	B-B-B	21 & 6	539	560
					0-280	120	58.1	CW	2-2-2	B-B-B			

6000 Series

PART NUMBER		WIRING	INPUT		OUTPUT			SHAFT ROTATION FOR VOLTAGE INCREASE	TERMINAL CONNECTIONS For Increasing Voltage As Viewed from Rotor End		SCHEMATIC (Pg 8 & 9)	NET WEIGHT IN LBS. (MAX)	
MANUALLY OPERATED	MOTOR DRIVEN		VOLTS	HERTZ	VOLTS	MAX AMPS	MAX KVA		INPUT	OUTPUT		MANUAL	MOTOR DRIVEN
6020-6D 6020E-6D	M6020-6D M6020E-6D	Three Phase Open Delta	240	50/60	0-240	105	43.6	CW	4-1-4	D-1-D	22 & 5	517	538
					0-280	105	50.9	CW	2-1-2	D-1-D			
6020-6P 6020E-6P	M6020-6P M6020E-6P	Single Phase Parallel	240	50/60	0-240	210	50.4	CW	1-4	1-D	22	489	510
					0-280	210	58.8	CW	1-2	1-D			
6020-6PS 6020E-6PS	M6020-6PS M6020E-6PS	Single Phase Series Parallel	240	50/60	0-240	105	50.4	CW	4-4	D-D	22 & 4	487	508
					0-560	105	58.8	CW	2-2	D-D			
6020-6Y 6020E-6Y	M6020-6Y M6020E-6Y	Three Phase Wye	480	50/60	0-480	70	58.1	CW	4-4-4	B-B-B	21 & 6	485	506
				60	0-560	70	67.8	CW	2-2-2	B-B-B			
6011-7P 6011E-7P	M6011-7P M6011E-7P	Single Phase Parallel	120	50/60	0-120	420	50.4	CW	1-4	1-D	22	633	654
					0-140	420	58.8	CW	1-2	1-D			
6020-7P 6020E-7P	M6020-7P M6020E-7P	Single Phase Parallel	240	50/60	0-240	245	58.8	CW	1-4	1-D	22	598	619
					0-280	245	68.6	CW	1-2	1-D			
6011-8D 6011E-8D	M6011-8D M6011E-8D	Three Phase Open Delta	120	50/60	0-120	240	49.8	CW	4-1-4	D-1-D	22 & 5	720	741
					0-140	240	58.1	CW	2-1-2	D-1-D			
6011-8P 6011E-8P	M6011-8P M6011E-8P	Single Phase Parallel	120	50/60	0-120	480	57.6	CW	1-4	1-D	22	722	743
					0-140	480	67.2	CW	1-2	1-D			
6011-8PS 6011E-8PS	M6011-8PS M6011E-8PS	Single Phase Series Parallel	240	50/60	0-240	240	57.6	CW	4-4	D-D	22 & 4	720	741
					0-280	240	67.2	CW	2-2	D-D			
6020-8D 6020E-8D	M6020-8D M6020E-8D	Three Phase Open Delta	240	50/60	0-240	140	58.1	CW	4-1-4	D-1-D	22 & 5	688	709
					0-280	140	67.8	CW	2-1-2	D-1-D			
6020-8P 6020E-8P	M6020-8P M6020E-8P	Single Phase Parallel	240	50/60	0-240	280	67.2	CW	1-4	1-D	22	690	711
					0-280	280	78.4	CW	1-2	1-D			
6020-8PS 6020E-8PS	M6020-8PS M6020E-8PS	Single Phase Series Parallel	480	50/60	0-480	140	67.2	CW	4-4	D-D	22 & 4	688	709
					0-560	140	78.4	CW	2-2	D-D			
6011-9P 6011E-9P	M6011-9P M6011E-9P	Single Phase Parallel	120	50/60	0-120	540	64.8	CW	1-4	1-D	22	811	832
					0-140	540	75.6	CW	1-2	1-D			
6011-9Y 6011E-9Y	M6011-9Y M6011E-9Y	Three Phase Wye	240	60	0-240	180	74.7	CW	4-4-4	D-D-D	22 & 6	807	828
					0-280	180	87.2	CW	2-2-2	D-D-D			
6020-9P 6020E-9P	M6020-9P M6020E-9P	Single Phase Parallel	240	50/60	0-240	315	75.6	CW	1-4	1-D	22	775	796
					0-280	315	88.2	CW	1-2	1-D			
6020-9Y 6020E-9Y	M6020-9Y M6020E-9Y	Three Phase Wye	480	50/60	0-480	105	87.2	CW	4-4-4	D-D-D	22 & 6	771	792
				60	0-560	105	101.7	CW	2-2-2	D-D-D			
—	M6011-10D M6011E-10D	Three Phase Open Delta	120	50/60	0-120	300	62.3	CW	4-1-4	D-1-D	22 & 5	—	912
					0-140	300	72.7	CW	2-1-2	D-1-D			
—	M6011-10PS M6011E-10PS	Single Phase Series Parallel	240	50/60	0-240	300	72.0	CW	4-4	D-D	22 & 4	—	912
					0-280	300	84.0	CW	2-2	D-D			
—	M6020-10D M6020E-10D	Three Phase Open Delta	240	50/60	0-240	175	72.7	CW	4-1-4	D-1-D	22 & 5	—	912
					0-280	175	84.8	CW	2-1-2	D-1-D			
			120	50/60	0-280	175*75 V.D.	36.3‡	CW	5-1-5	D-1-D			

6000 Series

PART NUMBER		WIRING	INPUT		OUTPUT			SHAFT ROTATION FOR VOLTAGE INCREASE	TERMINAL CONNECTIONS For Increasing Voltage As Viewed from Rotor End		SCHE-MATIC (Pg 8 & 9)	NET WEIGHT IN LBS. (MAX)	
MANUALLY OPERATED	MOTOR DRIVEN		VOLTS	HERTZ	VOLTS	MAX AMPS	MAX KVA		INPUT	OUTPUT		MAN-UAL	MOTOR DRIVEN
—	M6020-10PS M6020E-10PS	Single Phase Series Parallel	480	50/60	0-480 0-560	175 175	84.0 98.0	CW CW	4-4 2-2	D-D D-D	22 & 4	—	872
			240	50/60	0-560	175* ⁷⁵ V.D.	42.0‡	CW	5-5	D-D			
—	M6011-12D M6011E-12D	Three Phase Open Delta	120	50/60	0-120	360	74.7	CW	4-1-4	D-1-D	22 & 5	—	1060
					0-140	360	87.2	CW	2-1-2	D-1-D			
—	M6011-12PS M6011E-12PS	Single Phase Series Parallel	240	50/60	0-240	360	86.4	CW	4-4	D-D	22 & 4	—	1060
					0-280	360	100.8	CW	2-2	D-D			
—	M6020-12D M6020E-12D	Three Phase Open Delta	240	50/60	0-240 0-280	210 210	87.2 101.7	CW CW	4-1-4 2-1-2	D-1-D D-1-D	22 & 5	—	1012
			120	50/60	0-280	210* ⁹⁰ V.D.	43.6‡	CW	5-1-5	D-1-D			
—	M6020-12PS M6020E-12PS	Single Phase Series Parallel	480	50/60	0-480 0-560	210 210	100.8 117.6	CW CW	4-4 2-2	D-D D-D	22 & 4	—	1012
			240	50/60	0-560	210* ⁹⁰ V.D.	50.4‡	CW	5-5	D-D			
—	M6011-14D M6011E-14D	Three Phase Open Delta	120	50/60	0-120	420	87.2	CW	4-1-4	D-1-D	22 & 5	—	1237
					0-140	420	101.7	CW	2-1-2	D-1-D			
—	M6011-14PS M6011E-14PS	Single Phase Series Parallel	240	50/60	0-240	420	100.8	CW	4-4	D-D	22 & 4	—	1237
					0-280	420	117.6	CW	2-2	D-D			
—	M6020-14D M6020E-14D	Three Phase Open Delta	240	50/60	0-240 0-280	245 245	101.7 118.7	CW CW	4-1-4 2-1-2	D-1-D D-1-D	22 & 5	—	1181
			120	50/60	0-280	245* ¹⁰⁵ V.D.	50.9‡	CW	5-1-5	D-1-D			
—	M6020-14PS M6020E-14PS	Single Phase Series Parallel	480	50/60	0-480 0-560	245 245	117.6 137.2	CW CW	4-4 2-2	D-D D-D	22 & 4	—	1181
			240	50/60	0-560	245* ¹⁰⁵ V.D.	58.8‡	CW	5-5	D-D			
—	M6011-16D M6011E-16D	Three Phase Open Delta	120	50/60	0-120	480	99.6	CW	4-1-4	D-1-D	22 & 5	—	1414
					0-140	480	116.3	CW	2-1-2	D-1-D			
—	M6011-16PS M6011E-16PS	Single Phase Series Parallel	240	50/60	0-240	480	115.2	CW	4-4	D-D	22 & 4	—	1414
					0-280	480	134.4	CW	2-2	D-D			
—	M6020-16D M6020E-16D	Three Phase Open Delta	240	50/60	0-240 0-280	280 280	116.3 135.6	CW CW	4-1-4 2-1-2	D-1-D D-1-D	22 & 5	—	1350
			120	50/60	0-280	280* ¹²⁰ V.D.	58.1‡	CW	5-1-5	D-1-D			
—	M6020-16PS M6020E-16PS	Single Phase Series Parallel	480	50/60	0-480 0-560	280 280	134.4 156.8	CW CW	4-4 2-2	D-D D-D	22 & 4	—	1350
			240	50/60	0-560	280* ¹²⁰ V.D.	67.2‡	CW	5-5	D-D			
—	M6011-18D M6011E-18D	Three Phase Open Delta	120	50/60	0-120	540	112.1	CW	4-1-4	D-1-D	22 & 5	—	1597
					0-140	540	130.8	CW	2-1-2	D-1-D			
—	M6011-18PS M6011E-18PS	Single Phase Series Parallel	240	50/60	0-240	540	129.6	CW	4-4	D-D	22 & 4	—	1597
					0-280	540	151.2	CW	2-2	D-D			
—	M6020-18D M6020E-18D	Three Phase Open Delta	240	50/60	0-240 0-280	315 315	130.8 152.6	CW CW	4-1-4 2-1-2	D-1-D D-1-D	22 & 5	—	1525
			120	50/60	0-280	315* ¹³⁵ V.D.	94.5‡	CW	5-1-5	D-1-D			
—	M6020-18PS M6020E-18PS	Single Phase Series Parallel	480	50/60	0-480 0-560	315 315	151.2 176.4	CW CW	4-4 2-2	D-D D-D	22 & 4	—	1525
			240	50/60	0-560	315* ¹³⁵ V.D.	75.6‡	CW	5-5	D-D			
—	M6011-12Y M6011E-12Y	Three Phase Wye	240	60	0-240	240	99.6	CW	4-4-4	D-D-D	22 & 6	—	1062
					0-280	240	116.3	CW	2-2-2	D-D-D			

6000 Series

PART NUMBER		WIRING	INPUT		OUTPUT			SHAFT ROTATION FOR VOLTAGE INCREASE	TERMINAL CONNECTIONS For Increasing Voltage As Viewed from Rotor End		SCHEMATIC (Pg 8 & 9)	NET WEIGHT IN LBS. (MAX)	
MANUALLY OPERATED	MOTOR DRIVEN		VOLTS	HERTZ	VOLTS	MAX AMPS	MAX KVA		INPUT	OUTPUT		MANUAL	MOTOR DRIVEN
—	M6020-12Y M6020E-12Y	Three Phase Wye	480	50/60 60	0-480 0-560	140 140	116.3 135.6	CW CW	4-4-4 2-2-2	D-D-D D-D-D	22 & 6	—	1014
			240	60	0-560	140* 60 V.D.	58.1‡	CW	5-5-5	D-D-D			
—	M6011-15Y M6011E-15Y	Three Phase Wye	240	60	0-240 0-280	300 300	124.6 145.3	CW CW	4-4-4 2-2-2	D-D-D D-D-D	22 & 6	—	1329
—	M6020-15Y M6020E-15Y	Three Phase Wye	480	50/60 60	0-480 0-560	175 175	145.3 169.5	CW CW	4-4-4 2-2-2	D-D-D D-D-D	22 & 6	—	1269
			240	60	0-560	175* 75 V.D.	72.7‡	CW	5-5-5	D-D-D			
—	M6011-18Y M6011E-18Y	Three Phase Wye	240	60	0-240 0-280	360 360	149.5 174.4	CW CW	4-4-4 2-2-2	D-D-D D-D-D	22 & 6	—	1595
—	M6020-18Y M6020E-18Y	Three Phase Wye	480	50/60 60	0-480 0-560	210 210	174.6 203.4	CW CW	4-4-4 2-2-2	D-D-D D-D-D	22 & 6	—	1523
			240	60	0-560	210* 90 V.D.	87.2‡	CW	5-5-5	D-D-D			
—	M6011-21Y M6011E-21Y	Three Phase Wye	240	60	0-240 0-280	420 420	174.4 203.4	CW CW	4-4-4 2-2-2	D-D-D D-D-D	22 & 6	—	1864
—	M6020-21Y M6020E-21Y	Three Phase Wye	480	50/60 60	0-480 0-560	245 245	203.4 237.4	CW CW	4-4-4 2-2-2	D-D-D D-D-D	22 & 6	—	1780
			240	60	0-560	245* 105 V.D.	101.7‡	CW	5-5-5	D-D-D			
—	M6011-24Y M6011E-24Y	Three Phase Wye	240	60	0-240 0-280	480 480	199.3 232.5	CW CW	4-4-4 2-2-2	D-D-D D-D-D	22 & 6	—	2132
—	M6020-24Y M6020E-24Y	Three Phase Wye	480	50/60 60	0-480 0-560	280 280	232.5 271.3	CW CW	4-4-4 2-2-2	D-D-D D-D-D	22 & 6	—	2036
			240	60	0-560	280* 120 V.D.	116.3‡	CW	5-5-5	D-D-D			
—	M6011-27Y M6011E-27Y	Three Phase Wye	240	60	0-240 0-280	540 540	224.2 261.6	CW CW	4-4-4 2-2-2	D-D-D D-D-D	22 & 6	—	2401
—	M6020-27Y M6020E-27Y	Three Phase Wye	480	50/60 60	0-480 0-560	315 315	261.6 305.2	CW CW	4-4-4 2-2-2	D-D-D D-D-D	22 & 6	—	2293
			240	60	0-560	315* 135 V.D.	130.8‡	CW	5-5-5	D-D-D			

* Maximum output current in output voltage range from 0 to 25 percent above line voltage. At higher output voltages, output current must be reduced according to rating curve Figure B, page 6.

‡ Maximum KVA at maximum output and corresponding de-rated current. Maximum KVA at lower output voltages may be calculated from rating curve Figure B, page 6.

V.D. Voltage Doubler

Данный компонент на территории Российской Федерации

Вы можете приобрести в компании MosChip.

Для оперативного оформления запроса Вам необходимо перейти по данной ссылке:

<http://moschip.ru/get-element>

Вы можете разместить у нас заказ для любого Вашего проекта, будь то серийное производство или разработка единичного прибора.

В нашем ассортименте представлены ведущие мировые производители активных и пассивных электронных компонентов.

Нашей специализацией является поставка электронной компонентной базы двойного назначения, продукции таких производителей как XILINX, Intel (ex.ALTERA), Vicor, Microchip, Texas Instruments, Analog Devices, Mini-Circuits, Amphenol, Glenair.

Сотрудничество с глобальными дистрибьюторами электронных компонентов, предоставляет возможность заказывать и получать с международных складов практически любой перечень компонентов в оптимальные для Вас сроки.

На всех этапах разработки и производства наши партнеры могут получить квалифицированную поддержку опытных инженеров.

Система менеджмента качества компании отвечает требованиям в соответствии с ГОСТ Р ИСО 9001, ГОСТ РВ 0015-002 и ЭС РД 009

Офис по работе с юридическими лицами:

105318, г.Москва, ул.Щербаковская д.3, офис 1107, 1118, ДЦ «Щербаковский»

Телефон: +7 495 668-12-70 (многоканальный)

Факс: +7 495 668-12-70 (доб.304)

E-mail: info@moschip.ru

Skype отдела продаж:

moschip.ru

moschip.ru_4

moschip.ru_6

moschip.ru_9