

MINIMUM INSERTION LOSS IN dB LINE TO GROUND IN 50 OHM CIRCUIT								MINIMUM INSERTION LOSS IN dB LINE TO LINE IN 50 OHM CIRCUIT							
CURRENT RATING	FREQUENCY MHz							CURRENT RATING	FREQUENCY MHz						
	0.15	0.5	1	3	5	10	30		0.15	0.5	1	3	5	10	30
H MODELS															
3 AMP	21	27	30	29	26	23	15	3 AMP	4	12	18	31	40	48	41
6 AMP	11	15	17	19	18	16	13	6 AMP	4	12	16	26	35	40	35
10 AMP	5	8	10	12	11	11	10	10 AMP	4	12	16	26	33	40	32
S MODELS															
3 AMP	21	27	33	40	44	50	32	3 AMP	4	12	15	30	48	50	45
6 AMP	12	17	23	32	36	44	30	6 AMP	4	12	15	22	42	55	45
10 AMP	5	10	13	23	27	35	27	10 AMP	4	12	15	22	42	55	45

STYLE	DIMENSION 'A'		DIMENSION B
	UNSHIELDED	SHIELDED	
	PS	1.06	1.12
PSL	1.12		2.201 *
PE	1.12	1.12	2.201 *
PM	1.06	1.12	2.13
PSC	1.06	1.12	2.52
PSJ	1.06	1.12	2.6

* FOR PANEL THICKNESS OF 0.031"-0.079" ONLY.
USE 2.213 FOR PANEL THICKNESS OF 0.083"-0.114"

SHEET 1 OF 2			
ECN#	APPRVD	DATE	REV
10-002963	ELC	19AUG10	C
12-015327	TAM	22AUG12	D

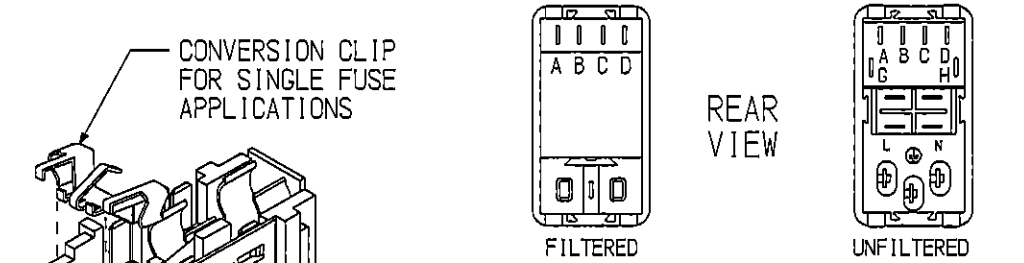
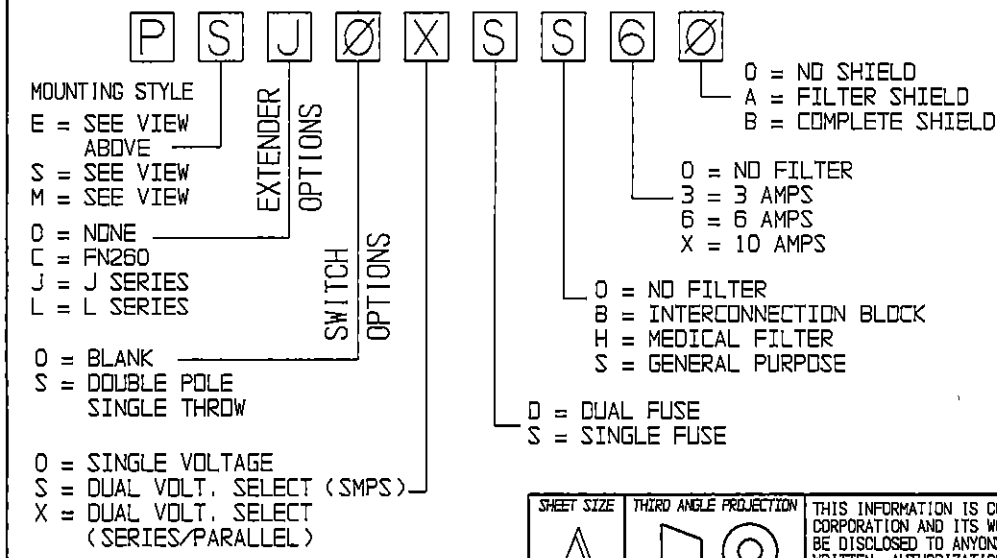
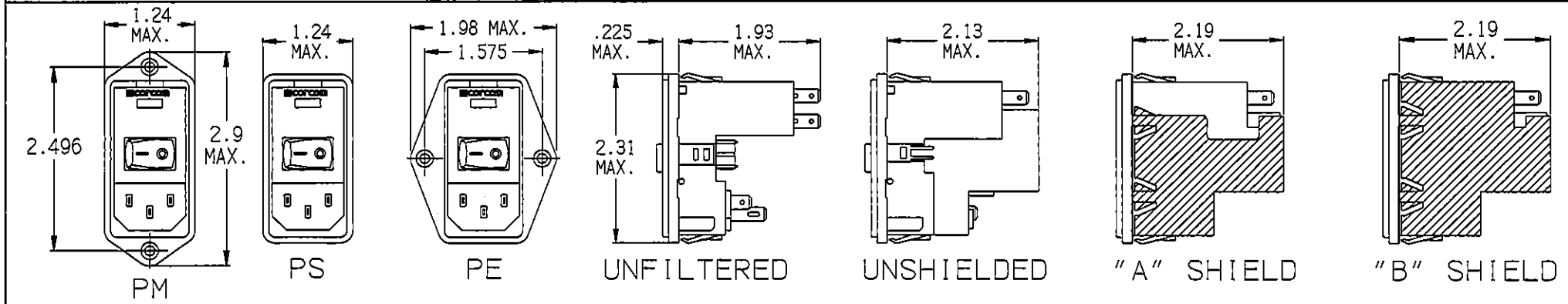
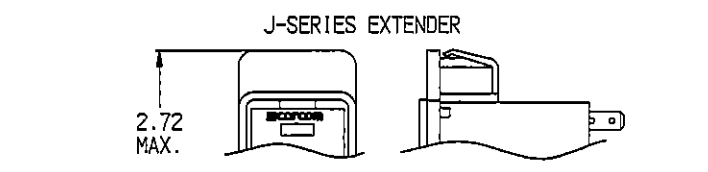
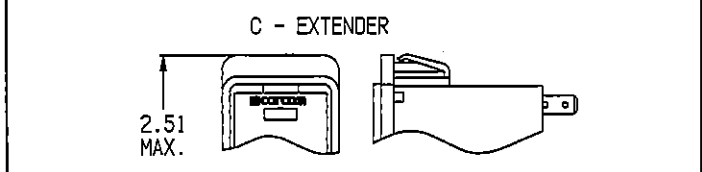
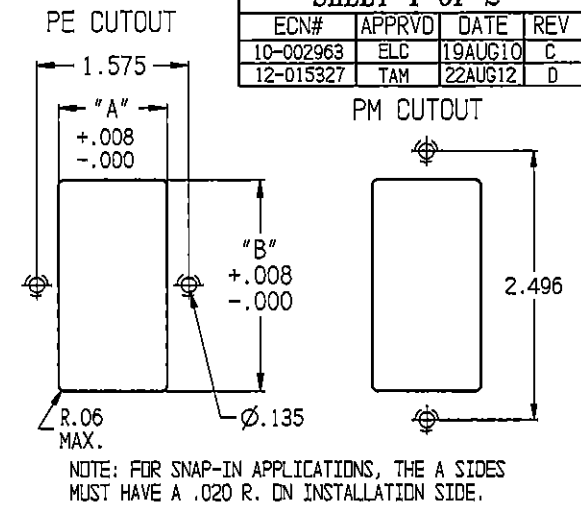

Tyco Electronics
 CORCOM PRODUCTS, 620 S. BUTTERFIELD RD. MUNDLEIN IL 60060

CUSTOMER DRAWING
P-SERIES

TYCO ELECTRONICS PART NO.

SCALE: 1:2	DATE: 2-4-97	DRAWING NUMBER: P-SERIES	REV. D
DRW. BY:	ORIG:		

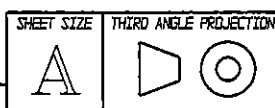

THIS INFORMATION IS CONFIDENTIAL AND PROPRIETARY TO TYCO ELECTRONICS CORPORATION AND ITS WORLDWIDE SUBSIDIARIES AND AFFILIATES. IT MAY NOT BE DISCLOSED TO ANYONE OTHER THAN TYCO ELECTRONICS PERSONNEL, WITHOUT WRITTEN AUTHORIZATION FROM TYCO ELECTRONICS CORPORATION, HARRISBURG, PENNSYLVANIA USA.

SPECIFICATIONS

HIPOT RATING (ONE MINUTE)	
LINE TO GROUND:	1500 VAC
LINE TO LINE:	1450 VDC
OPERATING FREQUENCY:	50/60 Hz
RATED VOLTAGE:	120/250 VAC
OPERATING VOLTAGES:	115/230 VAC
SELECTABLE OR FIXED:	SELECTABLE FUSEHOLDER ACCEPTS 1 OR 2 FUSES 1/4" x 1-1/4" OR 5 x 20mm
OPERATING AMBIENT TEMP.:	-10°C TO +40°C
STORAGE TEMPERATURE:	-40°C TO +85°C
HUMIDITY:	21 DAYS, 40°C @95% RH.
CURRENT OVERLOAD TEST:	6 TIMES I _R FOR 8 SECONDS



NOTE 1: JUMPERS ARE REQUIRED IF A FILTER OR INTERCONNECTION MODULE IS NOT USED.
 NOTE 2: LOCATION OF OPTIONAL FILTER. JUMPERS ARE REQUIRED IF A FILTER OR INTERCONNECTION MODULE IS NOT USED.

NONFILTERED MODELS

RATED CURRENT; I _R :	10A @ 120 VAC 10A @ 250 VAC
---------------------------------	--------------------------------

FILTERED MODELS

MAXIMUM LEAKAGE CURRENT, EACH LINE TO GROUND	
@ 120 VAC 60Hz:	H MODELS 2µA S MODELS 0.25m
@ 250 VAC 50Hz:	H MODELS 5µA S MODELS 0.50mA

RATED CURRENT; I _R :	3, 6 & 10 AMP MODELS AVAILABLE
---------------------------------	-----------------------------------

GENERAL NOTES:
 CONVERSION CLIP PROVIDED ON FUSEHOLDER FOR SINGLE FUZE MODELS.
 SWITCH: DOUBLE INSULATED RATED FOR 10,000 OPERATIONS AT FULL LOAD.
 51 AMP INRUSH CAPABILITY.
 TERMINALS: FOUR 0.187" x 0.032" QUICK CONNECT TABS
 ONE SOLDER TERMINAL

SAFETY ORGANIZATIONS

THIS FILTER HAS BEEN FORMALLY RECOGNIZED, CERTIFIED OR APPROVED BY THE LISTED AGENCY. THEREFORE, ALL TEST/REQUIREMENTS SPECIFIED IN THE LATEST REVISION OF THE FOLLOWING AGENCY STANDARDS HAVE BEEN MET:

UL RECOGNIZED
 CSA CERTIFIED
 VDE APPROVED



SEE INDIVIDUAL CUSTOMER DRAWINGS FOR OTHER (L AND Z) P-SERIES VERSIONS.

Tyco Electronics
 CORCOM PRODUCTS, 620 S. BUTTERFIELD RD. MUNDELEIN IL 60060

CUSTOMER DRAWING
 P-SERIES

TYCO ELECTRONICS PART NO.

SCALE: NA	DATE: 2/4/97	DRAWING NUMBER: P-SERIES	REV. D
DRW. BY:	ORIG:		

SHEET SIZE A	THIRD ANGLE PROJECTION
-----------------	------------------------

THIS INFORMATION IS CONFIDENTIAL AND PROPRIETARY TO TYCO ELECTRONICS CORPORATION AND ITS WORLDWIDE SUBSIDIARIES AND AFFILIATES. IT MAY NOT BE DISCLOSED TO ANYONE OTHER THAN TYCO ELECTRONICS PERSONNEL, WITHOUT WRITTEN AUTHORIZATION FROM TYCO ELECTRONICS CORPORATION, HARRISBURG, PENNSYLVANIA USA.

Данный компонент на территории Российской Федерации

Вы можете приобрести в компании MosChip.

Для оперативного оформления запроса Вам необходимо перейти по данной ссылке:

<http://moschip.ru/get-element>

Вы можете разместить у нас заказ для любого Вашего проекта, будь то серийное производство или разработка единичного прибора.

В нашем ассортименте представлены ведущие мировые производители активных и пассивных электронных компонентов.

Нашей специализацией является поставка электронной компонентной базы двойного назначения, продукции таких производителей как XILINX, Intel (ex.ALTERA), Vicor, Microchip, Texas Instruments, Analog Devices, Mini-Circuits, Amphenol, Glenair.

Сотрудничество с глобальными дистрибьюторами электронных компонентов, предоставляет возможность заказывать и получать с международных складов практически любой перечень компонентов в оптимальные для Вас сроки.

На всех этапах разработки и производства наши партнеры могут получить квалифицированную поддержку опытных инженеров.

Система менеджмента качества компании отвечает требованиям в соответствии с ГОСТ Р ИСО 9001, ГОСТ РВ 0015-002 и ЭС РД 009

Офис по работе с юридическими лицами:

105318, г.Москва, ул.Щербаковская д.3, офис 1107, 1118, ДЦ «Щербаковский»

Телефон: +7 495 668-12-70 (многоканальный)

Факс: +7 495 668-12-70 (доб.304)

E-mail: info@moschip.ru

Skype отдела продаж:

moschip.ru

moschip.ru_4

moschip.ru_6

moschip.ru_9