



## IR Receiver Modules for Remote Control Systems



22531-1



### FEATURES

- Height of 0.8 mm
- ± 75° half angle sensitivity
- Low supply current
- Photo detectors and preamplifier in one package
- Internal filter for PCM frequency
- Supply voltage: 2.5 V to 5.5 V, typically even 2.0 V to 5.5 V is possible
- Improved immunity against ambient light
- Insensitive to supply voltage ripple and noise
- Material categorization: for definitions of compliance please see [www.vishay.com/doc?99912](http://www.vishay.com/doc?99912)



**RoHS**  
COMPLIANT  
HALOGEN  
**FREE**  
**GREEN**  
(5-2008)

### ORDERING CODE

#### Taping:

TSOP57...TT1 - top view taped

TSOP57...TT2 - top view taped

### DESCRIPTION

The TSOP57... series are miniaturized SMD IR receiver modules for infrared remote control systems. A PIN diode and a preamplifier are assembled on a PCB, the epoxy package contains an IR filter.

The demodulated output signal can be directly connected to a microprocessor for decoding.

The TSOP572.., TSOP574.. are optimized to suppress almost all spurious pulses from energy saving lamps like CFLs. The AGC4 used in the TSOP574.. may suppress some data signals. The TSOP572.. is a legacy product for all common IR remote control data formats. Between these two receiver types, the TSOP574.. is preferred. Customers should initially try the TSOP574.. in their design.

These components have not been qualified according to automotive specifications.

PARTS TABLE			
AGC		LEGACY, FOR LONG BURST REMOTE CONTROLS (AGC2)	RECOMMENDED FOR LONG BURST CODES (AGC4) (1)
Carrier frequency	36 kHz	TSOP57236	TSOP57436 (2)(3)(4)
	38 kHz	TSOP57238	TSOP57438 (5)(6)
	40 kHz	TSOP57240	TSOP57440
	56 kHz	TSOP57256	TSOP57456 (7)(8)
Package		Belobog	
Pinning		1 = OUT, 2, 3, 6, 7, 8 = GND, 4, 5 = V <sub>S</sub>	
Dimensions (mm)		3.95 W x 3.95 H x 0.8 D	
Mounting		SMD	
Application		Remote control	
Best remote control code		(2) RC-5 (3) RC-6 (4) Panasonic (5) NEC (6) Sharp (7) r-step (8) Thomson RCA	

#### Note

(1) We advise try AGC4 first if the burst length is unknown.

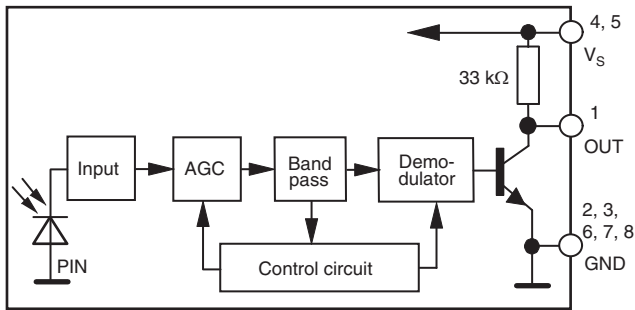
**BLOCK DIAGRAM**

20445-6

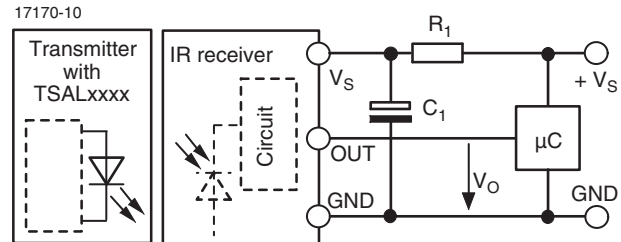
**APPLICATION CIRCUIT**

The external components  $R_1$  and  $C_1$  are optional to improve the robustness against electrical overstress (typical values are  $R_1 = 100 \Omega$ ,  $C_1 = 0.1 \mu\text{F}$ ).

**ABSOLUTE MAXIMUM RATINGS**

PARAMETER	TEST CONDITION	SYMBOL	VALUE	UNIT
Supply voltage		$V_S$	-0.3 to +6	V
Supply current		$I_S$	5	mA
Output voltage		$V_O$	-0.3 to $(V_S + 0.3)$	V
Output current		$I_O$	5	mA
Junction temperature		$T_j$	100	$^{\circ}\text{C}$
Storage temperature range		$T_{\text{stg}}$	-25 to +85	$^{\circ}\text{C}$
Operating temperature range		$T_{\text{amb}}$	-25 to +85	$^{\circ}\text{C}$
Power consumption	$T_{\text{amb}} \leq 85 \text{ }^{\circ}\text{C}$	$P_{\text{tot}}$	10	mW

**Note**

- Stresses beyond those listed under "Absolute Maximum Ratings" may cause permanent damage to the device. This is a stress rating only and functional operation of the device at these or any other conditions beyond those indicated in the operational sections of this specification is not implied. Exposure to absolute maximum rating conditions for extended periods may affect the device reliability.

**ELECTRICAL AND OPTICAL CHARACTERISTICS** ( $T_{\text{amb}} = 25 \text{ }^{\circ}\text{C}$ , unless otherwise specified)

PARAMETER	TEST CONDITION	SYMBOL	MIN.	TYP.	MAX.	UNIT
Supply voltage		$V_S$	2.5		5.5	V
Supply current	$V_S = 5 \text{ V}$ , $E_v = 0$	$I_{\text{SD}}$	0.55	0.7	0.9	mA
	$E_v = 40 \text{ klx}$ , sunlight	$I_{\text{SH}}$		0.8		mA
Transmission distance	$E_v = 0$ , IR diode TSAL6200, $I_F = 250 \text{ mA}$ , test signal see fig. 1	$d$		40		m
Output voltage low	$I_{\text{OSL}} = 0.5 \text{ mA}$ , $E_e = 0.7 \text{ mW/m}^2$ , test signal see fig. 1	$V_{\text{OSL}}$			100	mV
Minimum irradiance	Pulse width tolerance: $t_{\text{pi}} - 5/f_o < t_{\text{po}} < t_{\text{pi}} + 6/f_o$ , test signal see fig. 1	$E_e \text{ min.}$		0.2	0.4	$\text{mW/m}^2$
Maximum irradiance	$t_{\text{pi}} - 5/f_o < t_{\text{po}} < t_{\text{pi}} + 6/f_o$ , test signal see fig. 1	$E_e \text{ max.}$	50			$\text{W/m}^2$
Directivity	Angle of half transmission distance	$\phi_{1/2}$		$\pm 75$		deg

**TYPICAL CHARACTERISTICS** ( $T_{amb} = 25\text{ }^{\circ}\text{C}$ , unless otherwise specified)

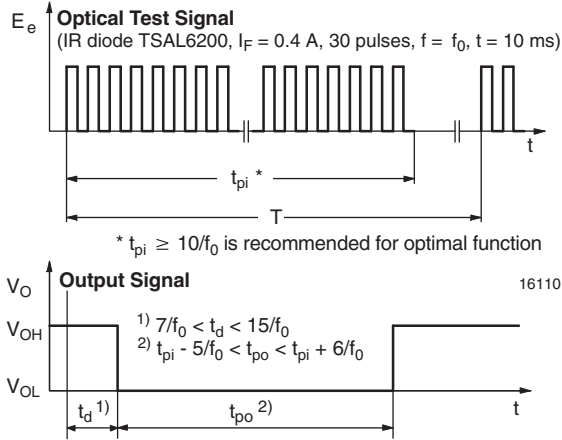

Fig. 1 - Output Active Low

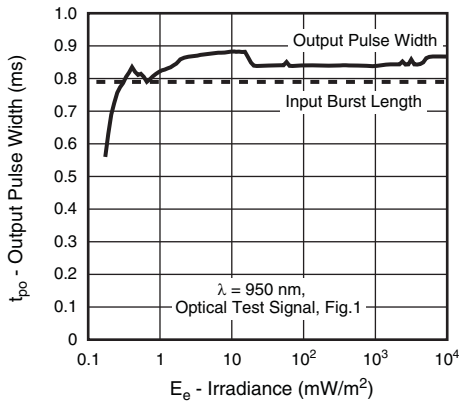

Fig. 2 - Pulse Length and Sensitivity in Dark Ambient

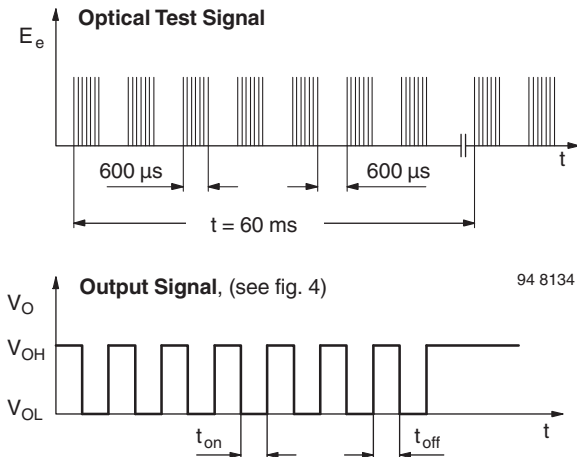

Fig. 3 - Output Function

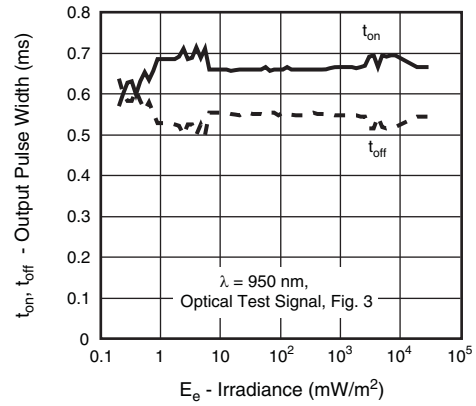

Fig. 4 - Output Pulse Diagram

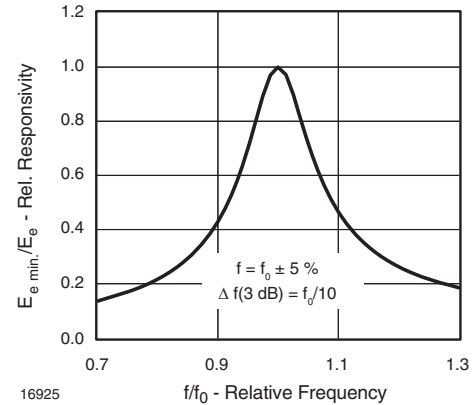

Fig. 5 - Frequency Dependence of Responsivity

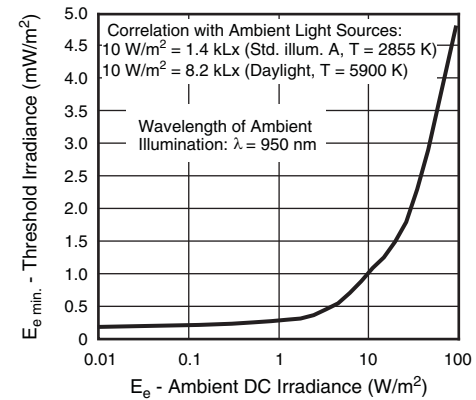

Fig. 6 - Sensitivity in Bright Ambient

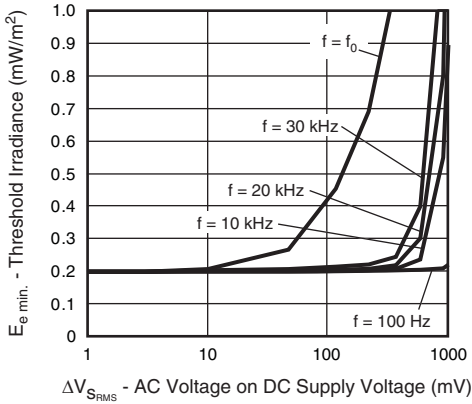

Fig. 7 - Sensitivity vs. Supply Voltage Disturbances

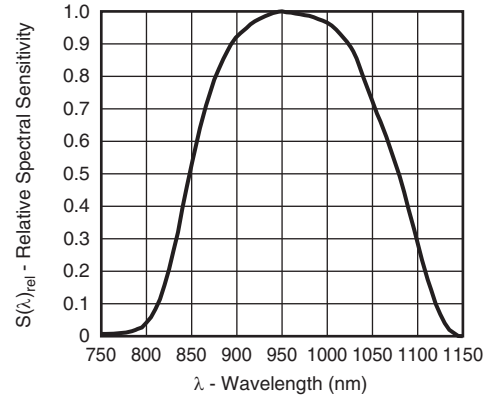

Fig. 10 - Relative Spectral Sensitivity vs. Wavelength

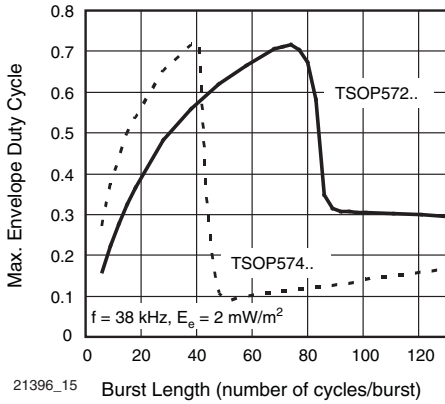

Fig. 8 - Max. Envelope Duty Cycle vs. Burst Length

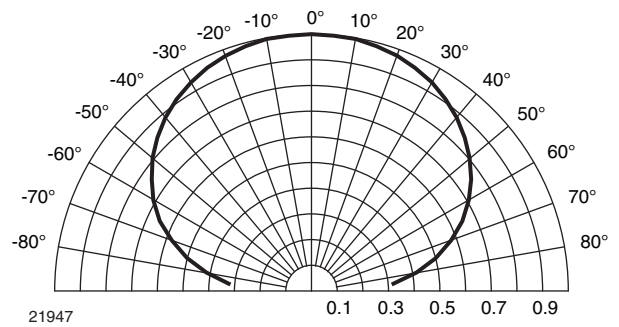

Fig. 11 - Horizontal Directivity

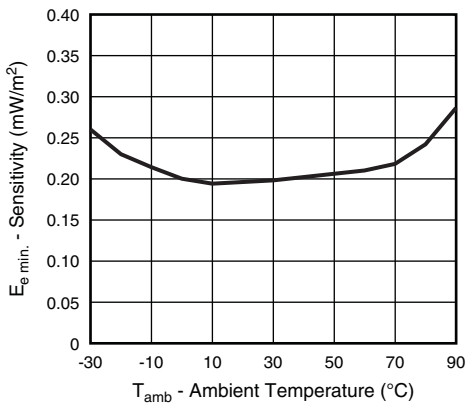

Fig. 9 - Sensitivity vs. Ambient Temperature

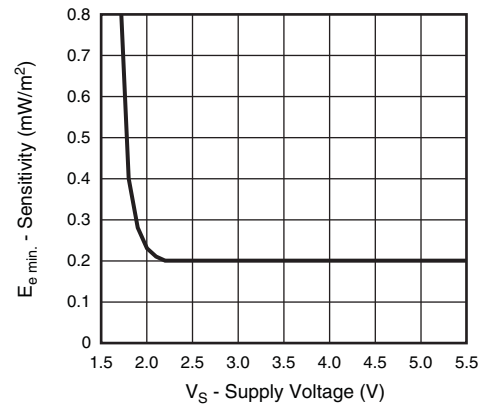

Fig. 12 - Sensitivity vs. Supply Voltage

**SUITABLE DATA FORMAT**

The TSOP572.., TSOP574.. series is designed to suppress spurious output pulses due to noise or disturbance signals. The devices can distinguish data signals from noise due to differences in frequency, burst length, and envelope duty cycle. The data signal should be close to the device's band-pass center frequency (e.g. 38 kHz) and fulfill the conditions in the table below.

When a data signal is applied to the TSOP572.., TSOP574.. in the presence of a disturbance, the sensitivity of the receiver is automatically reduced by the AGC to insure that no spurious pulses are present at the receiver's output. Some examples which are suppressed are:

- DC light (e.g. from tungsten bulbs sunlight)
- Continuous signals at any frequency
- Strongly or weakly modulated patterns from fluorescent lamps with electronic ballasts (see figure 12 or figure 13)

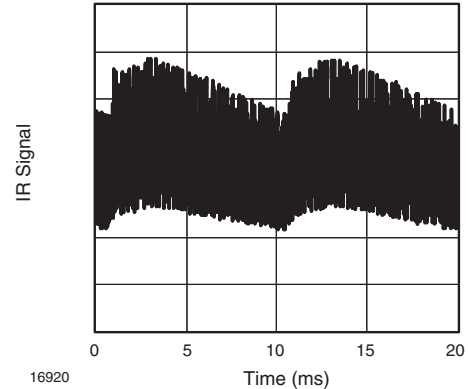

Fig. 13 - IR Signal from Fluorescent Lamp with Low Modulation

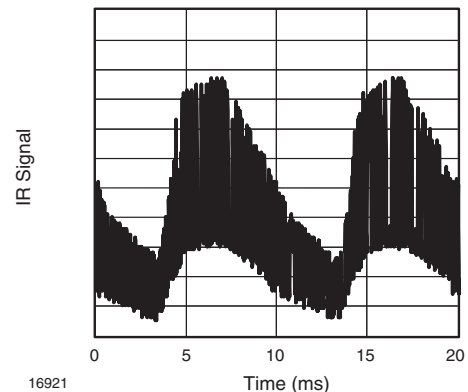

Fig. 14 - IR Signal from Fluorescent Lamp with High Modulation

	<b>TSOP572..</b>	<b>TSOP574..</b>
Minimum burst length	10 cycles/burst	10 cycles/burst
After each burst of length a minimum gap time is required of	10 to 70 cycles ≥ 10 cycles	10 to 42 cycles ≥ 10 cycles
For bursts greater than a minimum gap time in the data stream is needed of	70 cycles > 4 x burst length	42 cycles > 10 x burst length
Maximum number of continuous short bursts/second	800	1300
NEC code	yes	preferred
RC5/RC6 code	yes	preferred
Thomson 56 kHz code	yes	preferred
Suppression of interference from fluorescent lamps	Most common disturbance patterns are suppressed	Even extreme disturbance patterns are suppressed

**Notes**

- For data formats with short bursts please see the datasheet for TSOP573..
- Best choice of AGC for some popular IR-codes:  
 TSOP57436: RC-5, RC-6, Panasonic;  
 TSOP57438: NEC, Sharp, r-step;  
 TSOP57456: r-step, Thomson RCA

**PACKAGE DIMENSIONS** in millimeters

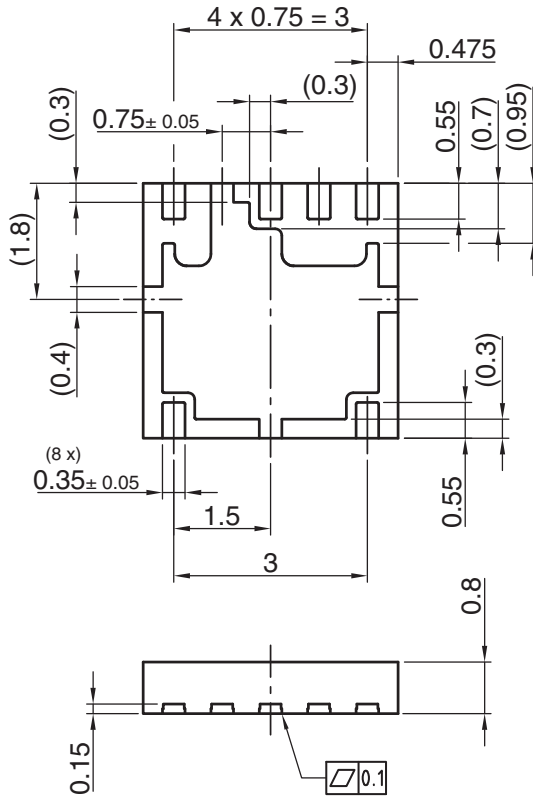

All dimensions in mm  
Not indicated tolerances  $\pm 0.1$

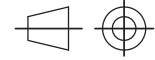

technical drawings according to DIN specifications

(2) Pins connected internally. It is not necessary to connect externally.

**Pinning from Topview**

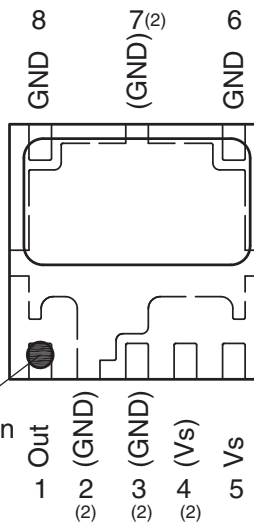

(1) optically effective area

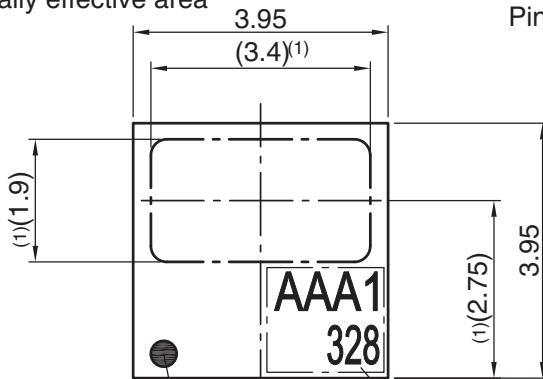

Drawing refers to following types: TSOP37... / TSOP57...

Drawing-No.: 6.550-5315.01-4

Issue: 2; 12.02.14

Proposed pad layout from component side (dim. for reference only)

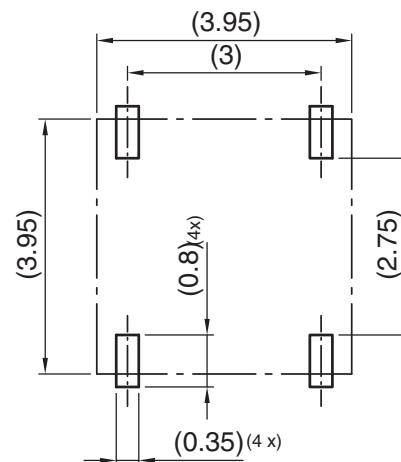



### ASSEMBLY INSTRUCTIONS

#### Reflow Soldering

- Reflow soldering must be done within 168 h while stored under a max. temperature of 30 °C, 60 % RH after opening the dry pack envelope
- Set the furnace temperatures for pre-heating and heating in accordance with the reflow temperature profile as shown in the diagram. Exercise extreme care to keep the maximum temperature below 260 °C. The temperature shown in the profile means the temperature at the device surface. Since there is a temperature difference between the component and the circuit board, it should be verified that the temperature of the device is accurately being measured
- Handling after reflow should be done only after the work surface has been cooled off

#### Manual Soldering

- Use a soldering iron of 25 W or less. Adjust the temperature of the soldering iron below 300 °C
- Finish soldering within 3 s
- Handle products only after the temperature has cooled off

### VISHAY LEAD (Pb)-FREE REFLOW SOLDER PROFILE

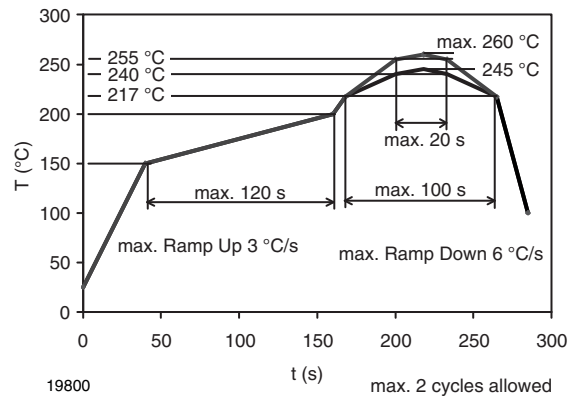

ORDERING INFORMATION			
ORDERING CODE	PACKAGING	VOLUME <sup>(1)</sup>	REMARKS
TSOP57..TT1	Tape and reel	MOQ: 1800 pcs	3.95 mm x 3.95 mm x 0.75 mm
TSOP57..TT2		MOQ: 7000 pcs	

#### Note

<sup>(1)</sup> MOQ: minimum order quantity

## TAPING VERSION TSOP57... DIMENSIONS in millimeters



Drawing-No.: 9.700-5347.01-4  
 Issue: 1; 14.11.11

Not indicated tolerances  $\pm 0.1$



**LABEL**
**Standard bar code labels for finished goods**

The standard bar code labels are product labels and used for identification of goods. The finished goods are packed in final packing area. The standard packing units are labeled

with standard bar code labels before transported as finished goods to warehouses. The labels are on each packing unit and contain Vishay Semiconductor GmbH specific data.

<b>VISHAY SEMICONDUCTOR GmbH STANDARD BAR CODE PRODUCT LABEL (finished goods)</b>		
<b>PLAIN WRITING</b>	<b>ABBREVIATION</b>	<b>LENGTH</b>
Item-description	-	18
Item-number	INO	8
Selection-code	SEL	3
LOT-/serial-number	BATCH	10
Data-code	COD	3 (YWW)
Plant-code	PTC	2
Quantity	QTY	8
Accepted by	ACC	-
Packed by	PCK	-
Mixed code indicator	MIXED CODE	-
Origin	xxxxxxx+	Company logo
<b>Long bar code top</b>	<b>Type</b>	<b>Length</b>
Item-number	N	8
Plant-code	N	2
Sequence-number	X	3
Quantity	N	8
Total length	-	21
<b>Short bar code bottom</b>	<b>Type</b>	<b>Length</b>
Selection-code	X	3
Data-code	N	3
Batch-number	X	10
Filter	-	1
Total length	-	17

**DRY PACKING**

The reel is packed in an anti-humidity bag to protect the devices from absorbing moisture during transportation and storage.

**FINAL PACKING**

The sealed reel is packed into a cardboard box. A secondary cardboard box is used for shipping purposes.

**RECOMMENDED METHOD OF STORAGE**

Dry box storage is recommended as soon as the aluminum bag has been opened to prevent moisture absorption. The following conditions should be observed, if dry boxes are not available:

- Storage temperature 10 °C to 30 °C
- Storage humidity ≤ 60 % RH max.

After more than 168 h under these conditions moisture content will be too high for reflow soldering.

In case of moisture absorption, the devices will recover to the former condition by drying under the following condition: 192 h at 40 °C + 5 °C / - 0 °C and < 5 % RH (dry air / nitrogen) or

96 h at 60 °C + 5 °C and < 5 % RH for all device containers or

24 h at 125 °C + 5 °C not suitable for reel or tubes.

An EIA JEDEC® standard J-STD-020 level 3 label is included on all dry bags.





**Caution**  
This bag contains  
**MOISTURE-SENSITIVE DEVICES**

**LEVEL**  
**3**

If blank, see adjacent bar code label

1. Calculated shelf life in sealed bag: 12 months at <40°C and <90% relative humidity (RH)
2. Peak package body temperature: 260 °C  
If blank, see adjacent bar code label
3. After bag is opened, devices that will be subjected to reflow solder or other high temperature process must be
  - a) Mounted within: 168 hours of factory conditions  
If blank, see adjacent bar code label  
<30°C/60% RH, or
  - b) Stored per J-STD-033
4. Devices require bake, before mounting, if:
  - a) Humidity Indicator Card reads > 10% for level 2a - 5a devices or >60% for level 2 devices when read at 23±5°C
  - b) 3a or 3b are not met
5. If baking is required, refer to IPC/JEDEC J-STD-033 for bake procedure

Bag Seal Date: \_\_\_\_\_  
If blank, see adjacent bar code label

Note: Level and body temperature defined by IPC/JEDEC J-STD-020

22650

EIA JEDEC standard J-STD-020 level 3 label is included on all dry bags

### ESD PRECAUTION

Proper storage and handling procedures should be followed to prevent ESD damage to the devices especially when they are removed from the antistatic shielding bag. Electrostatic sensitive devices warning labels are on the packaging.

### VISHAY SEMICONDUCTORS STANDARD BAR CODE LABELS

The Vishay Semiconductors standard bar code labels are printed at final packing areas. The labels are on each packing unit and contain Vishay Semiconductors specific data.

### BAR CODE PRODUCT LABEL (example)



22178



## Disclaimer

ALL PRODUCT, PRODUCT SPECIFICATIONS AND DATA ARE SUBJECT TO CHANGE WITHOUT NOTICE TO IMPROVE RELIABILITY, FUNCTION OR DESIGN OR OTHERWISE.

Vishay Intertechnology, Inc., its affiliates, agents, and employees, and all persons acting on its or their behalf (collectively, "Vishay"), disclaim any and all liability for any errors, inaccuracies or incompleteness contained in any datasheet or in any other disclosure relating to any product.

Vishay makes no warranty, representation or guarantee regarding the suitability of the products for any particular purpose or the continuing production of any product. To the maximum extent permitted by applicable law, Vishay disclaims (i) any and all liability arising out of the application or use of any product, (ii) any and all liability, including without limitation special, consequential or incidental damages, and (iii) any and all implied warranties, including warranties of fitness for particular purpose, non-infringement and merchantability.

Statements regarding the suitability of products for certain types of applications are based on Vishay's knowledge of typical requirements that are often placed on Vishay products in generic applications. Such statements are not binding statements about the suitability of products for a particular application. It is the customer's responsibility to validate that a particular product with the properties described in the product specification is suitable for use in a particular application. Parameters provided in datasheets and/or specifications may vary in different applications and performance may vary over time. All operating parameters, including typical parameters, must be validated for each customer application by the customer's technical experts. Product specifications do not expand or otherwise modify Vishay's terms and conditions of purchase, including but not limited to the warranty expressed therein.

Except as expressly indicated in writing, Vishay products are not designed for use in medical, life-saving, or life-sustaining applications or for any other application in which the failure of the Vishay product could result in personal injury or death. Customers using or selling Vishay products not expressly indicated for use in such applications do so at their own risk. Please contact authorized Vishay personnel to obtain written terms and conditions regarding products designed for such applications.

No license, express or implied, by estoppel or otherwise, to any intellectual property rights is granted by this document or by any conduct of Vishay. Product names and markings noted herein may be trademarks of their respective owners.

## Material Category Policy

**Vishay Intertechnology, Inc. hereby certifies that all its products that are identified as RoHS-Compliant fulfill the definitions and restrictions defined under Directive 2011/65/EU of The European Parliament and of the Council of June 8, 2011 on the restriction of the use of certain hazardous substances in electrical and electronic equipment (EEE) - recast, unless otherwise specified as non-compliant.**

**Please note that some Vishay documentation may still make reference to RoHS Directive 2002/95/EC. We confirm that all the products identified as being compliant to Directive 2002/95/EC conform to Directive 2011/65/EU.**

**Vishay Intertechnology, Inc. hereby certifies that all its products that are identified as Halogen-Free follow Halogen-Free requirements as per JEDEC JS709A standards. Please note that some Vishay documentation may still make reference to the IEC 61249-2-21 definition. We confirm that all the products identified as being compliant to IEC 61249-2-21 conform to JEDEC JS709A standards.**

## Данный компонент на территории Российской Федерации

### Вы можете приобрести в компании MosChip.

Для оперативного оформления запроса Вам необходимо перейти по данной ссылке:

<http://moschip.ru/get-element>

Вы можете разместить у нас заказ для любого Вашего проекта, будь то серийное производство или разработка единичного прибора.

В нашем ассортименте представлены ведущие мировые производители активных и пассивных электронных компонентов.

Нашей специализацией является поставка электронной компонентной базы двойного назначения, продукции таких производителей как XILINX, Intel (ex.ALTERA), Vicor, Microchip, Texas Instruments, Analog Devices, Mini-Circuits, Amphenol, Glenair.

Сотрудничество с глобальными дистрибьюторами электронных компонентов, предоставляет возможность заказывать и получать с международных складов практически любой перечень компонентов в оптимальные для Вас сроки.

На всех этапах разработки и производства наши партнеры могут получить квалифицированную поддержку опытных инженеров.

Система менеджмента качества компании отвечает требованиям в соответствии с ГОСТ Р ИСО 9001, ГОСТ РВ 0015-002 и ЭС РД 009

### Офис по работе с юридическими лицами:

105318, г.Москва, ул.Щербаковская д.3, офис 1107, 1118, ДЦ «Щербаковский»

Телефон: +7 495 668-12-70 (многоканальный)

Факс: +7 495 668-12-70 (доб.304)

E-mail: [info@moschip.ru](mailto:info@moschip.ru)

Skype отдела продаж:

moschip.ru

moschip.ru\_4

moschip.ru\_6

moschip.ru\_9