

## High Sensitivity Omni-Polar Hall Effect Switch

### TO-92S



#### Pin Definition:

1. V<sub>CC</sub>
2. GND
3. Output

### SOT-23



#### Pin Definition:

1. V<sub>CC</sub>
2. Output
3. GND

## Description

TSH253 Hall-effect sensor is a temperature stable, stress-resistant switch. Superior high-temperature performance is made possible through a dynamic offset cancellation that utilizes chopper-stabilization. This method reduces the offset voltage normally caused by device over molding, temperature dependencies, and thermal stress. TSH253 includes the following on a single silicon chip: voltage regulator, Hall voltage generator, small-signal amplifier, chopper stabilization, Schmitt trigger, open-drain output. Advanced CMOS wafer fabrication processing is used to take advantage of low-voltage requirements, component matching, very low input-offset errors, and small component geometries.

## Features

- CMOS Hall IC Technology
- Solid-State Reliability much better than reed switch
- Omni polar output switches with absolute value of North or South pole from magnet
- Operation down to 1.8 V and Max at 6V.
- High Sensitivity for reed switch replacement
- ESD HBM ±4KV Min

## Ordering Information

Part No.	Package	Packing
TSH253CT B0G	TO-92S	1Kpcs / Bulk Bag
TSH253CX RFG	SOT-23	3Kpcs / 7" Reel

**Note:** "G" denote for Halogen Free Product

## Application

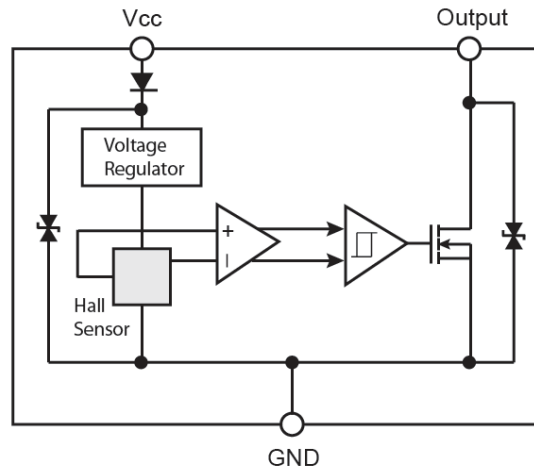
- Solid state switch, Revolution counter
- Lid close sensor for power supply devices
- Magnet proximity sensor for reed switch replacement in high duty cycle applications.
- Safety Key on sporting equipment
- Speed sensor, Position Sensor, Rotation Sensor

## Absolute Maximum Rating (T<sub>a</sub> = 25°C unless otherwise noted)

Characteristics	Limit	Value	Unit
Supply voltage	V <sub>CC</sub>	6	V
Output Voltage	V <sub>OUT</sub>	6	V
Reverse voltage	V <sub>CC/OUT</sub>	-0.3	V
Magnetic flux density		Unlimited	Gauss
Output current	I <sub>OUT</sub>	1	mA
Operating Temperature Range	T <sub>OPR</sub>	-40 to +85	°C
Storage temperature range	T <sub>STG</sub>	-55 to +150	°C
Maximum Junction Temp	T <sub>J</sub>	150	°C
Thermal Resistance - Junction to Ambient	TO-92S	206	°C/W
	SOT-23	543	
Thermal Resistance - Junction to Case	TO-92S	148	°C/W
	SOT-23	410	
Package Power Dissipation	TO-92S	606	mW
	SOT-23	230	

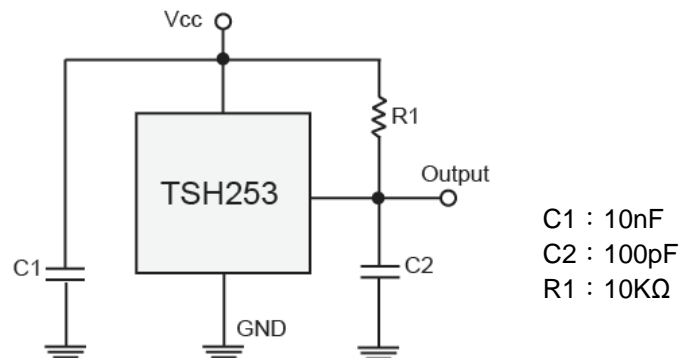
**Note:** Exceeding the absolute maximum ratings may cause permanent damage. Exposure to absolute maximum-rated conditions for extended periods may affect device reliability.

### Block Diagram



**Note:** Static sensitive device; please observe ESD precautions. Reverse VDD protection is not included. For reverse voltage protection, a 100Ω resistor in series with VDD is recommended.

### Typical Application Circuit



### Electrical Specifications (DC Operating Parameters : $T_A=+25^{\circ}\text{C}$ , $V_{CC}=5\text{V}$ )

Parameters	Test Conditions	Min	Typ	Max	Units
Supply Voltage	Operating	1.8	--	6	V
Supply Current	Average	--	2.6	6.0	mA
Output Low Voltage	$I_{OUT}=0.5\text{mA}$	--	--	200	mV
Output Leakage Current	$I_{OFF} \quad B < B_{RP}, \quad V_{OUT} = 3\text{V}$	--	--	10	uA
Output Rise Time	$R_L=10\text{k}\Omega, \quad C_L=20\text{pF}$	--	--	0.45	uS
Output Fall Time	$R_L=10\text{k}\Omega; \quad C_L=20\text{pF}$	--	--	0.45	uS
Electro-Static Discharge	HBM	4	--	--	KV

### Magnetic Specifications (TSH253CT)

Parameter	Symbol	Test Conditions	Min.	Typ.	Max.	Units
Operating Point	B <sub>OPS</sub>	S pole to branded side, B > B <sub>OP</sub> , Vout On		30	60	Gauss
	B <sub>OPN</sub>	N pole to branded side, B > B <sub>OP</sub> , Vout On	-60	-30		Gauss
Release Point	B <sub>RPS</sub>	S pole to branded side, B < B <sub>RP</sub> , Vout Off	5	25		Gauss
	B <sub>RPN</sub>	N pole to branded side, B < B <sub>RP</sub> , Vout Off		-25	-5	Gauss
Hysteresis	B <sub>HYS</sub>	BOP <sub>x</sub> - BRP <sub>x</sub>		5		Gauss

Note: 1G (Gauss) = 0.1mT (millitesta)

### Magnetic Specifications (TSH253CX)

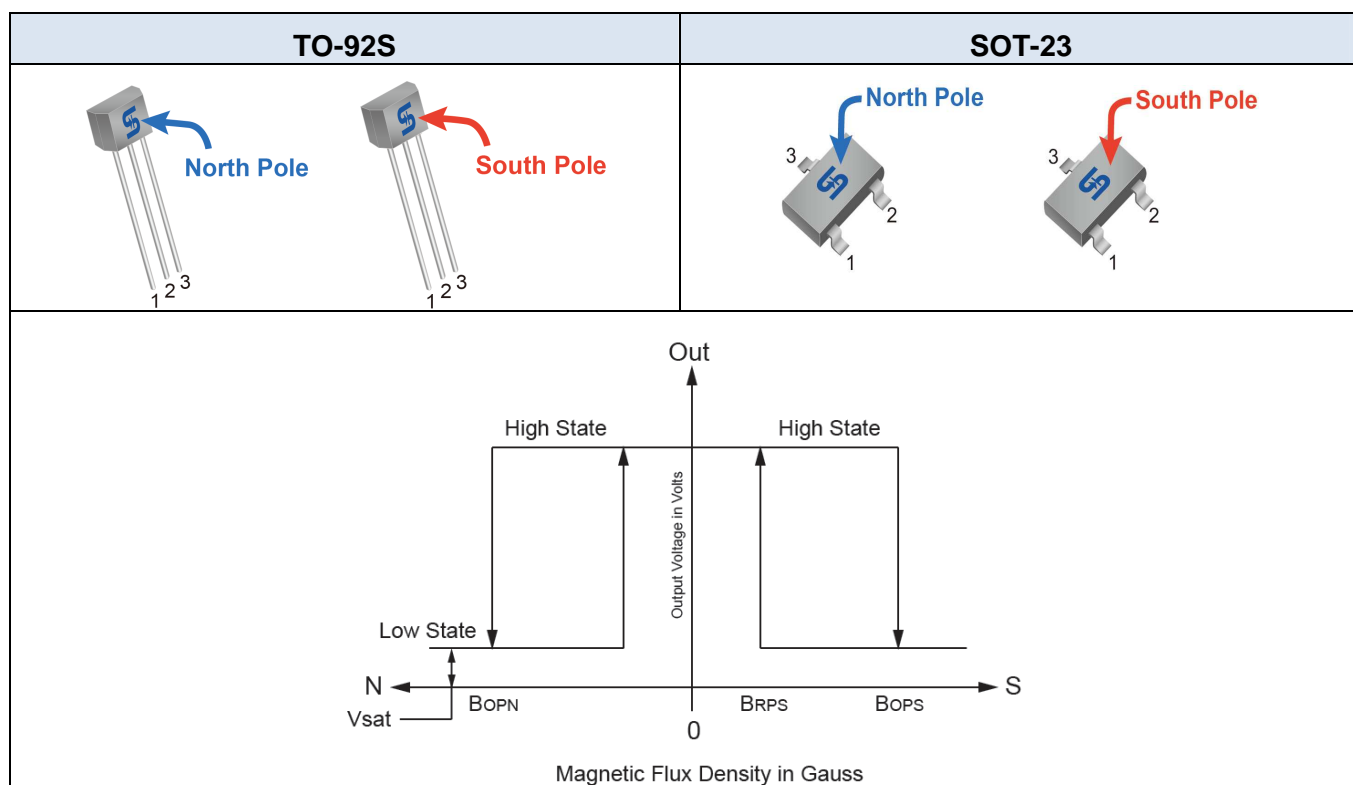
Parameter	Symbol	Test Conditions	Min.	Typ.	Max.	Units
Operating Point	B <sub>OPS</sub>	N pole to branded side, B > B <sub>OP</sub> , Vout On	--	30	60	Gauss
	B <sub>OPN</sub>	S pole to branded side, B > B <sub>OP</sub> , Vout On	-60	-30	--	Gauss
Release Point	B <sub>RPS</sub>	N pole to branded side, B < B <sub>RP</sub> , Vout Off	5	25	--	Gauss
	B <sub>RPN</sub>	S pole to branded side, B < B <sub>RP</sub> , Vout Off	--	-25	-5	Gauss
Hysteresis	B <sub>HYS</sub>	BOP <sub>x</sub> - BRP <sub>x</sub>	--	5	--	Gauss

Note: 1G (Gauss) = 0.1mT (millitesta)

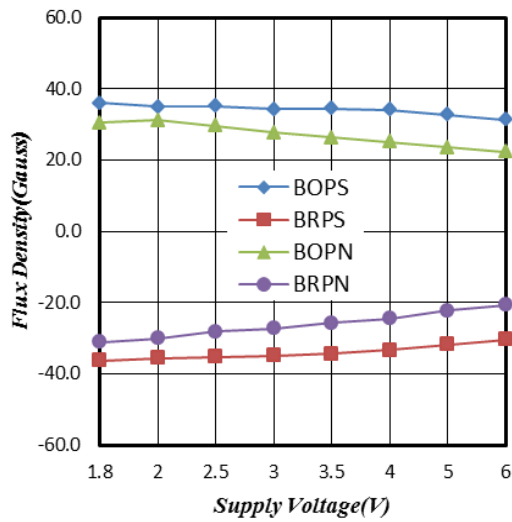
### Output Behavior versus Magnetic Pole

DC Operating Parameters: T<sub>A</sub> = -40 to 125°C, V<sub>CC</sub> = 1.8V ~ 6V

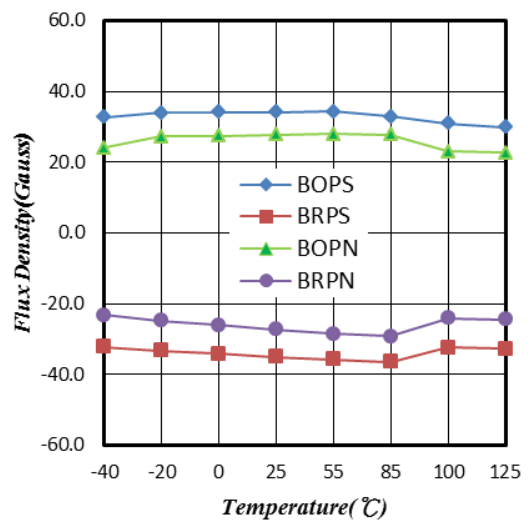
Parameter	Test condition	OUT
South pole	B < Bop[(-60)~(-5)]	Low
Null or weak magnetic field	B=0 or B < BRP	Open(Pull-up Voltage)
North pole	B > Bop(60~5)	Low



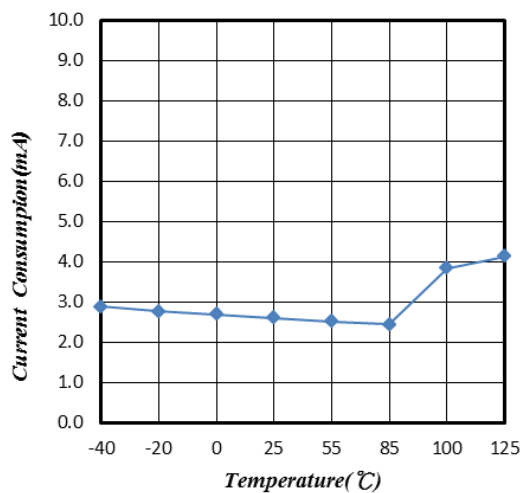
**Characteristic Performance**



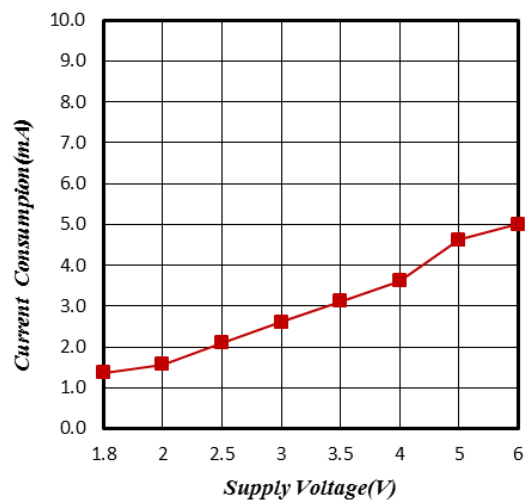
**Figure 1. Supply Voltage vs. Flux Density**



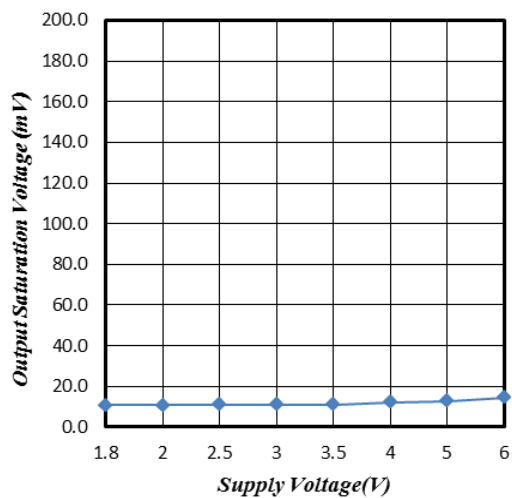
**Figure 2. Temperature vs. Flux Density**



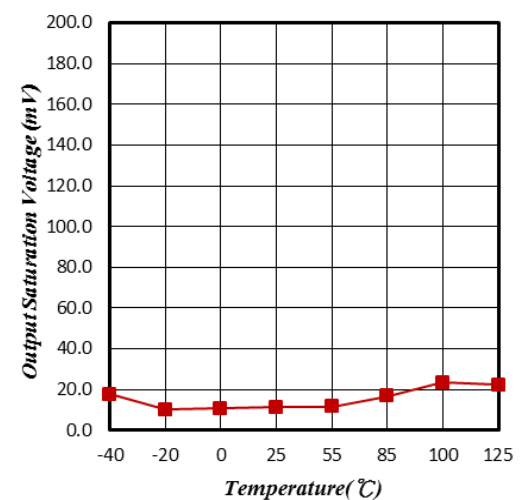
**Figure 3. Supply Current vs. Temperature**



**Figure 4. Supply Current vs. Supply Voltage**

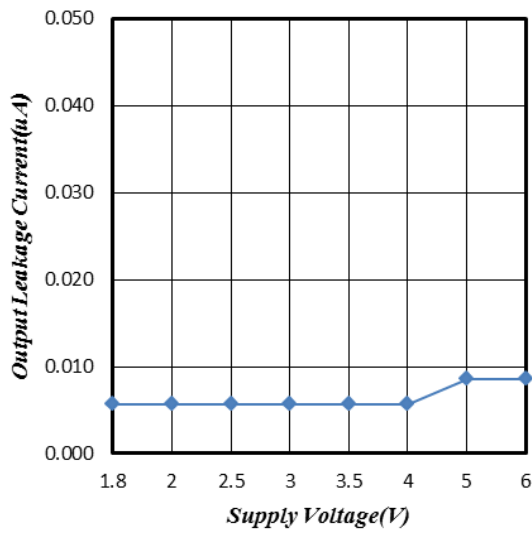


**Figure 5. Output Saturation Voltage vs. Supply Voltage**

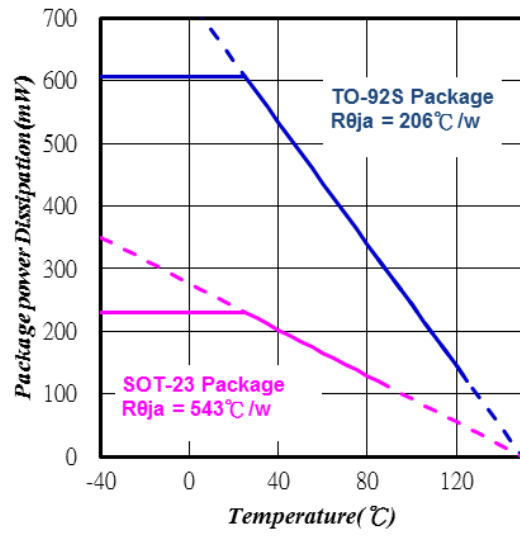


**Figure 6. Output Saturation Voltage vs. Temperature**

**Characteristic Performance**



**Figure 7. Output Leakage Current vs. Supply Voltage**



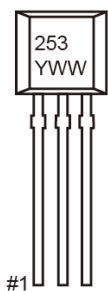
**Figure 8. Power Dissipation vs. Temperature**

**TO-92S Mechanical Drawing**



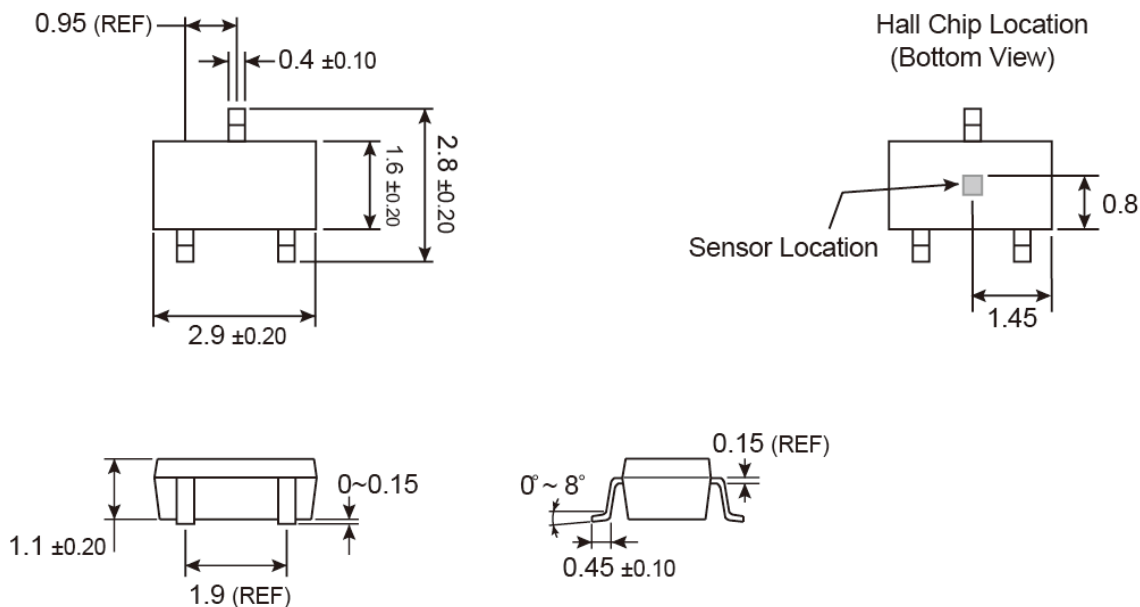
Unit: Millimeters

**Marking Diagram**



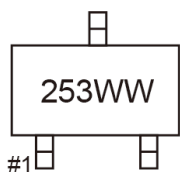
**253** = Device Code  
**Y** = Year Code (3=2013, 4=2014....)  
**WW** = Week Code (01~52)

**SOT-23 Mechanical Drawing**



Unit: Millimeters

**Marking Diagram**



**253** = Device Code  
**WW** = Week Code Table

week	1	2	3	4	5	6	7	8	9	10	11	12	13
code	OA	OB	OC	OD	OE	OF	OG	OH	OI	OJ	OK	OL	OM
week	14	15	16	17	18	19	20	21	22	23	24	25	26
code	ON	OO	OP	OQ	OR	OS	OT	OU	OV	OW	OX	OY	OZ
week	27	28	29	30	31	32	33	34	35	36	37	38	39
code	PA	PB	PC	PD	PE	PF	PG	PH	PI	PJ	PK	PL	PM
week	40	41	42	43	44	45	46	47	48	49	50	51	52
code	PN	PO	PP	PQ	PR	PS	PT	PU	PV	PW	PX	PY	PZ

## Notice

Specifications of the products displayed herein are subject to change without notice. TSC or anyone on its behalf, assumes no responsibility or liability for any errors or inaccuracies.

Information contained herein is intended to provide a product description only. No license, express or implied, to any intellectual property rights is granted by this document. Except as provided in TSC's terms and conditions of sale for such products, TSC assumes no liability whatsoever, and disclaims any express or implied warranty, relating to sale and/or use of TSC products including liability or warranties relating to fitness for a particular purpose, merchantability, or infringement of any patent, copyright, or other intellectual property right.

The products shown herein are not designed for use in medical, life-saving, or life-sustaining applications. Customers using or selling these products for use in such applications do so at their own risk and agree to fully indemnify TSC for any damages resulting from such improper use or sale.



## Данный компонент на территории Российской Федерации

### Вы можете приобрести в компании MosChip.

Для оперативного оформления запроса Вам необходимо перейти по данной ссылке:

<http://moschip.ru/get-element>

Вы можете разместить у нас заказ для любого Вашего проекта, будь то серийное производство или разработка единичного прибора.

В нашем ассортименте представлены ведущие мировые производители активных и пассивных электронных компонентов.

Нашей специализацией является поставка электронной компонентной базы двойного назначения, продукции таких производителей как XILINX, Intel (ex.ALTERA), Vicor, Microchip, Texas Instruments, Analog Devices, Mini-Circuits, Amphenol, Glenair.

Сотрудничество с глобальными дистрибьюторами электронных компонентов, предоставляет возможность заказывать и получать с международных складов практически любой перечень компонентов в оптимальные для Вас сроки.

На всех этапах разработки и производства наши партнеры могут получить квалифицированную поддержку опытных инженеров.

Система менеджмента качества компании отвечает требованиям в соответствии с ГОСТ Р ИСО 9001, ГОСТ РВ 0015-002 и ЭС РД 009

### Офис по работе с юридическими лицами:

105318, г.Москва, ул.Щербаковская д.3, офис 1107, 1118, ДЦ «Щербаковский»

Телефон: +7 495 668-12-70 (многоканальный)

Факс: +7 495 668-12-70 (доб.304)

E-mail: [info@moschip.ru](mailto:info@moschip.ru)

Skype отдела продаж:

moschip.ru

moschip.ru\_4

moschip.ru\_6

moschip.ru\_9