

## Description

The AP2552/53 and AP2552A/53A are single channel precision adjustable current-limited switches optimized for the applications require precision current limiting or to provide up to 2.1A of continuous load current during heavy loads/short circuits. These devices offer a programmable current-limit threshold between 75mA and 2.35A (typ) via an external resistor. Current limit accuracy  $\pm 6\%$  can be achieved at high current-limit settings. The rise and fall times are controlled to minimize current surges during turn on/off.

The devices have fast short-circuit response time for improved overall system robustness. They provide a complete protection solution for applications subject to heavy capacitive loads and the prospect of short circuit, offering reverse current blocking and limiting, over-current, over-temperature and short-circuit protection, as well as controlled rise time and under-voltage lockout functionality. A 7ms deglitch capability on the open-drain Flag output prevents false over-current reporting and does not require any external components.

AP2552/53 limits the output current to a safe level when the output current exceeds current-limit threshold.

AP2552A/53A provides latch-off function during over-current or reverse-voltage conditions.

All devices are available in SOT26 and U-DFN2020C-6 packages.

## Applications

- Set-Top-Boxes
- LCD TVs & Monitors
- Residential Gateways
- Laptops, Desktops, Servers, e-Readers, Printers, Docking Stations, HUBs

## Pin Assignments

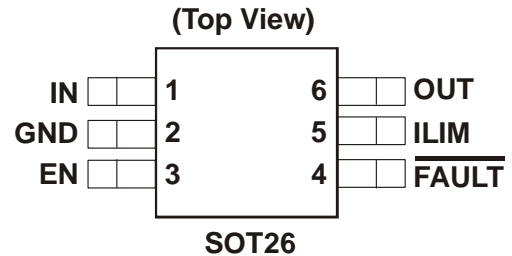
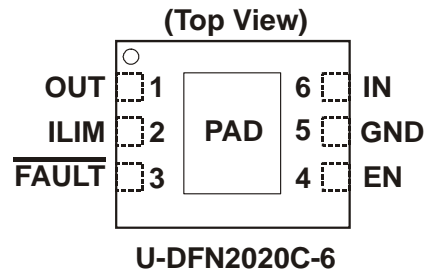

## Features

- Up to 2.1A maximum load current
- Accurate adjustable current limit, 75mA - 2350mA
- $\pm 6\%$  accurate adjustable current limit, 1.61A with  $R_{LIM} = 15k\Omega$
- Constant-current (AP2552/53) during over-current
- Output latch-off (AP2552A/53A) at over-current
- Fast short-circuit response time: 2 $\mu$ s (typ)
- Reverse current blocking during shutdown and reverse current limiting during enable
- Operating range: 2.7V – 5.5V
- Built-in soft-start with 3ms typical rise time
- Over-current, output over-voltage and thermal protection
- Fault report (FAULT) with blanking time
- ESD protection: 2kV HBM, 500V CDM
- Active low (AP2552/52A) or active high (AP2553/53A) enable
- Ambient temperature range: -40°C to +85°C
- SOT26 and DFN2020-6 package: Available in "Green" Molding Compound (No Br, Sb)
- **Totally Lead-Free & Fully RoHS Compliant (Notes 1 & 2)**
- **Halogen and Antimony Free. "Green" Device (Note 3)**
- 15kV ESD Protection per IEC 61000-4-2 (with external capacitance)
- UL Recognized, File Number (to be completed)
- IEC60950-1 CB Scheme Certified (to be completed)

Notes: 1. No purposely added lead. Fully EU Directive 2002/95/EC (RoHS) & 2011/65/EU (RoHS 2) compliant.  
2. See <http://www.diodes.com> for more information about Diodes Incorporated's definitions of Halogen- and Antimony-free, "Green" and Lead-free.  
3. Halogen- and Antimony-free "Green" products are defined as those which contain <900ppm bromine, <900ppm chlorine (<1500ppm total Br + Cl) and <1000ppm antimony compounds.

### Typical Applications Circuit

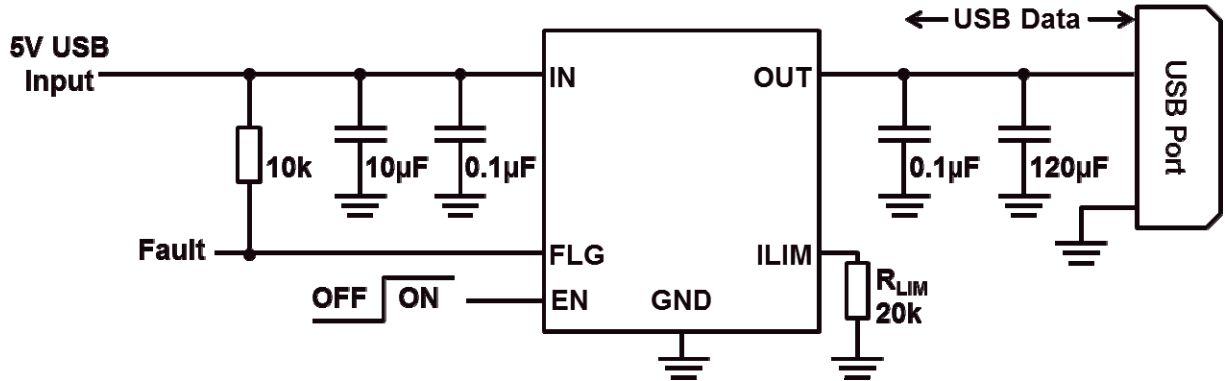

120µF Output Capacitance is a Requirement of USB

### Available Options

Part Number	Channel	Enable Pin (EN)	Recommended Maximum Continuous Load Current (A)	Current-Limit Protection	Package
AP2552	1	Active Low	2.1	Constant-Current	U-DFN2020C-6 SOT26
AP2553	1	Active High			
AP2552A	1	Active Low	2.1	Latch-Off	U-DFN2020C-6 SOT26
AP2553A	1	Active High			

### Pin Descriptions

Pin Name	Pin Number				I/O	Function
	AP2552W6-7	AP2553W6-7	AP2552FDCG-7	AP2553FDCG-7		
IN	1	1	6	6	I	Input, connect a 0.1µF or greater ceramic capacitor from IN to GND as close to IC as possible.
GND	2	2	5	5	—	Ground, connect to external exposed pad.
$\overline{\text{EN}}$	3	—	4	—	I	Enable input, logic low turns on power switch.
EN	—	3	—	4	I	Enable input, logic high turns on power switch.
$\overline{\text{FAULT}}$	4	4	3	3	O	Active-low open-drain output, asserted during over-current, over-temperature, or reverse-voltage conditions.
ILIM	5	5	2	2	O	Use external resistor to set current-limit threshold; recommended $10\text{k}\Omega \leq R_{\text{LIM}} \leq 232\text{k}\Omega$ .
OUT	6	6	1	1	O	Output
Exposed Pad	—	—	Pad	Pad	—	No internal connection; recommend to connect to GND externally for improved power dissipation.



**Absolute Maximum Ratings** (@T<sub>A</sub> = +25°C, unless otherwise specified.)

Symbol	Parameter	Ratings	Unit
ESD HBM	Human Body Model ESD Protection	2	kV
ESD CDM	Charged Device Model ESD Protection	500	V
V <sub>IN</sub> , V <sub>out</sub> , V <sub>FAULT</sub> , V <sub>ILIM</sub> , V <sub>EN</sub> , V <sub>EN</sub>	Voltage on IN, OUT, FAULT, ILIM, EN, EN	-0.3 to +6.5	V
	Continuous FAULT sink current	25	mA
	ILIM source current	1	mA
I <sub>load</sub>	Maximum Continuous Load Current	Internal Limited	A
T <sub>Jmax</sub>	Maximum Junction Temperature	-40 to +150	°C
T <sub>ST</sub>	Storage Temperature Range (Note 4)	-65 to +150	°C

Note: 4. UL Recognized Rating from -30°C to +70°C (Diodes qualified T<sub>ST</sub> from -65°C to +150°C)

Caution: Stresses greater than the 'Absolute Maximum Ratings' specified above, may cause permanent damage to the device. These are stress ratings only; functional operation of the device at these or any other conditions exceeding those indicated in this specification is not implied. Device reliability may be affected by exposure to absolute maximum rating conditions for extended periods of time.  
Semiconductor devices are ESD sensitive and may be damaged by exposure to ESD events. Suitable ESD precautions should be taken when handling and transporting these devices.

**Dissipation Rating Table**

Board	Package	Thermal Resistance θ <sub>JA</sub>	Thermal Resistance θ <sub>JC</sub>	T <sub>A</sub> ≤ +25°C Power Rating	Derating Factor Above T <sub>A</sub> = +25°C	T <sub>A</sub> = +70°C Power Rating	T <sub>A</sub> = +85°C Power Rating
High-K (Note 5)	W6	160°C/W	55°C/W	625mW	6.25mW/°C	340mW	250mW
High-K (Note 5)	FDC	120°C/W	34°C/W	833mW	8.33mW/°C	450mW	330mW

Note: 5. The JEDEC high-K (2s2p) board used to derive this data was a 3in x 3in, multilayer board with 1-ounce internal power and ground planes with 2-ounce copper traces on top and bottom of the board.

**Recommended Operating Conditions** (@T<sub>A</sub> = +25°C, unless otherwise specified.)

Symbol	Parameter	Min	Max	Unit
V <sub>IN</sub>	Input Voltage	2.7	5.5	V
I <sub>OUT</sub>	Continuous Output Current (-40°C ≤ T <sub>A</sub> ≤ +85°C)	0	2.1	A
V <sub>EN</sub> , V <sub>EN</sub>	Enable Voltage	0	5.5	V
V <sub>IH</sub>	High-Level Input Voltage on EN or EN	2.0	V <sub>IN</sub>	V
V <sub>IL</sub>	Low-Level Input Voltage on EN or EN	0	0.8	V
R <sub>LIM</sub>	Current-Limit Threshold Resistor Range (1% initial tolerance)	10	210	kΩ
I <sub>O</sub>	Continuous FAULT Sink Current	0	10	mA
	Input De-Coupling Capacitance, IN to GND	0.1		μF
T <sub>A</sub>	Operating Ambient Temperature	-40	+85	°C
T <sub>J</sub>	Operating Junction Temperature	-40	+125	°C

**Electrical Characteristics** (@T<sub>A</sub> = +25°C, V<sub>IN</sub> = 2.7V to 5.5V, V<sub>EN</sub> = 0V or V<sub>EN</sub> = V<sub>IN</sub>, R<sub>FAULT</sub> = 10kΩ, unless otherwise specified.)

Symbol	Parameter	Test Conditions (Note 6)	Min	Typ	Max	Unit	
<b>Supply</b>							
V <sub>UVLO</sub>	Input UVLO	V <sub>IN</sub> rising		2.4	2.65	V	
ΔV <sub>UVLO</sub>	Input UVLO Hysteresis	V <sub>IN</sub> decreasing		25		mV	
I <sub>SHDN</sub>	Input Shutdown Current	V <sub>IN</sub> = 5.5V, disabled, OUT = open		0.1	1	μA	
I <sub>Q</sub>	Input Quiescent Current	V <sub>IN</sub> = 5.5V, enabled, OUT = open, R <sub>LIM</sub> = 20kΩ		100	140	μA	
		V <sub>IN</sub> = 5.5V, enabled, OUT = open, R <sub>LIM</sub> = 210kΩ		80	120	μA	
I <sub>REV</sub>	Reverse Leakage Current	Disabled, V <sub>IN</sub> = 0V, V <sub>OUT</sub> = 6V, I <sub>REV</sub> at V <sub>IN</sub>		0.01	1	μA	
<b>Power Switch</b>							
R <sub>DS(ON)</sub>	Switch On-Resistance	SOT26 package,	T <sub>J</sub> = +25°C, V <sub>IN</sub> = 5.0V		70	95	mΩ
			-40°C ≤ T <sub>A</sub> ≤ +85°C			135	
		U-DFN2020-6 package	T <sub>J</sub> = +25°C, V <sub>IN</sub> = 5.0V		80	105	
			-40°C ≤ T <sub>A</sub> ≤ +85°C			150	
t <sub>R</sub>	Output Turn-On Rise Time	V <sub>IN</sub> = 5.5V, C <sub>L</sub> = 1μF, R <sub>LOAD</sub> = 100Ω. See Figure 1			1.1	1.5	ms
		V <sub>IN</sub> = 2.7V, C <sub>L</sub> = 1μF, R <sub>LOAD</sub> = 100Ω.			0.7	1	ms
t <sub>F</sub>	Output Turn-Off Fall Time	V <sub>IN</sub> = 5.5V, C <sub>L</sub> = 1μF, R <sub>LOAD</sub> = 100Ω. See Figure 1		0.1		0.5	ms
		V <sub>IN</sub> = 2.7V, C <sub>L</sub> = 1μF, R <sub>LOAD</sub> = 100Ω.		0.1		0.5	ms
<b>Current Limit</b>							
I <sub>LIMIT</sub>	Current-Limit Threshold (maximum DC output current), V <sub>OUT</sub> = V <sub>IN</sub> - 0.5V	R <sub>LIM</sub> = 10kΩ	-40°C ≤ T <sub>A</sub> ≤ +85°C	2200	2365	2542	mA
		R <sub>LIM</sub> = 15kΩ	-40°C ≤ T <sub>A</sub> ≤ +85°C	1540	1632	1730	
		R <sub>LIM</sub> = 20kΩ	T <sub>J</sub> = +25°C	1180	1251	1326	
			-40°C ≤ T <sub>A</sub> ≤ +85°C	1160	1251	1340	
		R <sub>LIM</sub> = 49.9kΩ	T <sub>J</sub> = +25°C	500	530	562	
			-40°C ≤ T <sub>A</sub> ≤ +85°C	485	529	573	
		R <sub>LIM</sub> = 210kΩ		121	142	162	
I <sub>LIM</sub> shorted to IN or GND		50	75	100			
I <sub>SHORT</sub>	Short-Circuit Current Limit, OUT connected to GND	R <sub>LIM</sub> = 10kΩ			2620		mA
		R <sub>LIM</sub> = 15kΩ			1820		
		R <sub>LIM</sub> = 20kΩ			1380		
		R <sub>LIM</sub> = 49.9kΩ			570		
		R <sub>LIM</sub> = 210kΩ			150		
		I <sub>LIM</sub> shorted to IN or GND			75		
t <sub>SHORT</sub>	Short-Circuit Response Time	V <sub>OUT</sub> = 0V to I <sub>OUT</sub> = I <sub>LIMIT</sub> (OUT shorted to ground) See Figure 2			2		μs
<b>Enable Pin</b>							
I <sub>LEAK-EN</sub>	EN Input Leakage Current	V <sub>IN</sub> = 5V, V <sub>EN</sub> = 0V and 6V		-0.5		0.5	μA
t <sub>ON</sub>	Turnon Time	C <sub>L</sub> = 1μF, R <sub>L</sub> = 100Ω. See Figure 1				3	ms
t <sub>OFF</sub>	Turnoff Time	C <sub>L</sub> = 1μF, R <sub>L</sub> = 100Ω. See Figure 1				1	ms
<b>Output Discharge</b>							
R <sub>DIS</sub>	Discharge Resistance (Note 7)	V <sub>IN</sub> = 5V, disabled, I <sub>OUT</sub> = 1mA			600		Ω
R <sub>DIS_LATCH</sub>	Discharge Resistance During Latch-Off	V <sub>IN</sub> = 5V, latch-off, AP2552A/53A only			1000		Ω

Notes: 6. Pulse-testing techniques maintain junction temperature close to ambient temperature; thermal effects must be taken into account separately.  
 7. The discharge function is active when the device is disabled (when enable is de-asserted or during power-up power-down when V<sub>IN</sub> < V<sub>UVLO</sub>).  
 The discharge function offers a resistive discharge path for the external storage capacitor for limited time.

**Electrical Characteristics** (cont.)

(@T<sub>A</sub> = +25°C, V<sub>IN</sub> = 2.7V to 5.5V, V<sub>EN</sub> = 0V or V<sub>EN</sub> = V<sub>IN</sub>, R<sub>FAULT</sub> = 10kΩ, unless otherwise specified.)

Symbol	Parameter	Test Conditions (Note 6)	Min	Typ	Max	Unit
<b>Reverse Voltage Protection</b>						
V <sub>RVP</sub>	Reverse-Voltage Comparator Trip Point	V <sub>OUT</sub> – V <sub>IN</sub>	95	135	190	mV
I <sub>ROCP</sub>	Reverse Current Limit	V <sub>OUT</sub> – V <sub>IN</sub> = 200mV		0.72		A
t <sub>TRIG</sub>	Time from Reverse-Voltage Condition to MOSFET Turn Off (AP2552A/AP2553A)	V <sub>IN</sub> = 5V	3	4.75	7	ms
<b>Fault Flag</b>						
V <sub>OL</sub>	FAULT Output Low Voltage	I <sub>FAULT</sub> = 1mA			180	mV
I <sub>FOH</sub>	FAULT Off Current	V <sub>FAULT</sub> = 6V			1	μA
t <sub>blank_OC</sub>	FAULT Blanking and Latch Off Time (Over-Current)	Assertion or deassertion due to overcurrent	5	7.5	10	ms
t <sub>blank_RV</sub>	FAULT Blanking Time (Reverse-Voltage)	Assertion or deassertion due to reverse-voltage	2	3.75	6	ms
<b>Thermal Shutdown</b>						
T <sub>SHDN</sub>	Thermal Shutdown Threshold	Enabled, R <sub>LOAD</sub> = 1kΩ		160		°C
T <sub>SHDN_OCP</sub>	Thermal Shutdown Threshold under Current Limit	Enabled, R <sub>LOAD</sub> = 1kΩ		140		°C
T <sub>HYS</sub>	Thermal Shutdown Hysteresis			20		°C

Note: 6. Pulse-testing techniques maintain junction temperature close to ambient temperature; thermal effects must be taken into account separately.

**Typical Performance Characteristics**

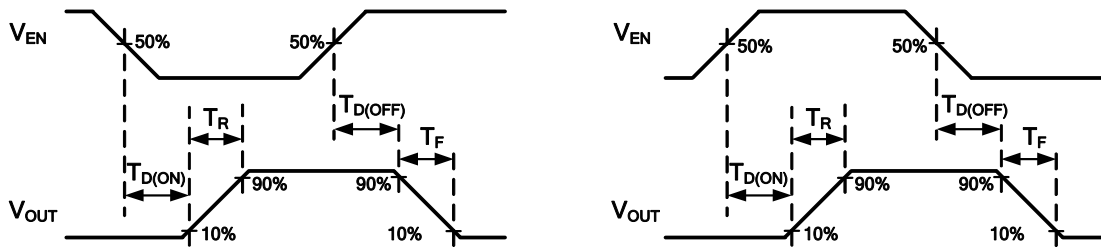

Figure 1. Voltage Waveforms: AP2552/52A (left), AP2553/53A (right)

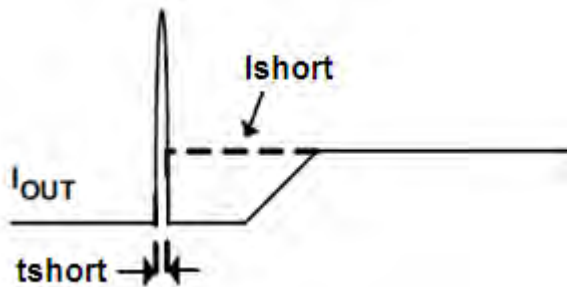

Figure 2. Response Time to Short Circuit Waveform

**Typical Performance Characteristics**

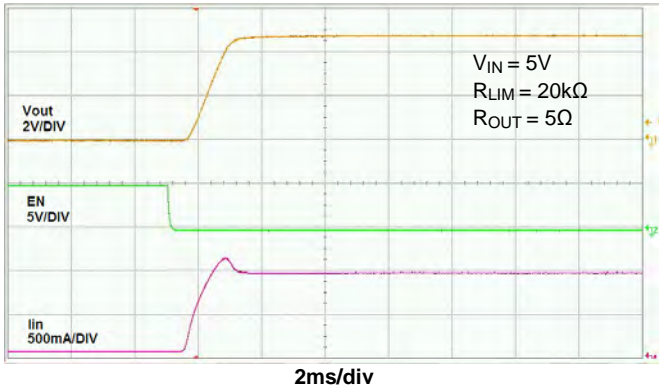

Figure 3. Turn-On Delay and Rise Time

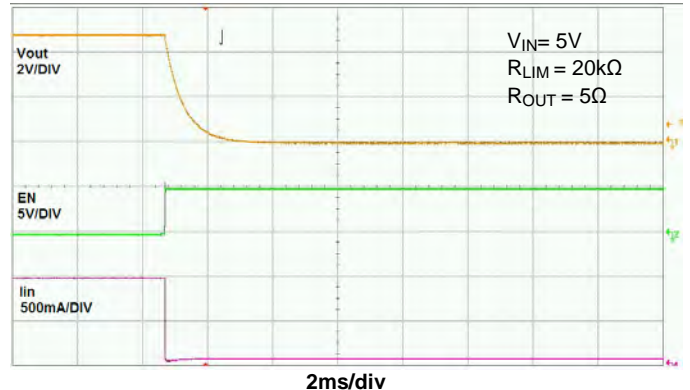

Figure 4. Turn-Off Delay and Fall Time

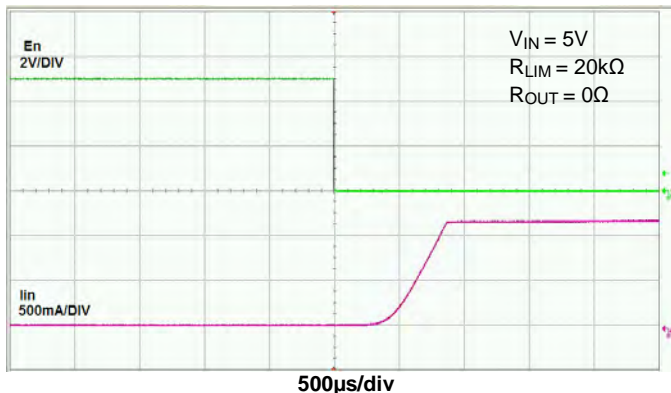

Figure 5. Device Enabled into Short-circuit

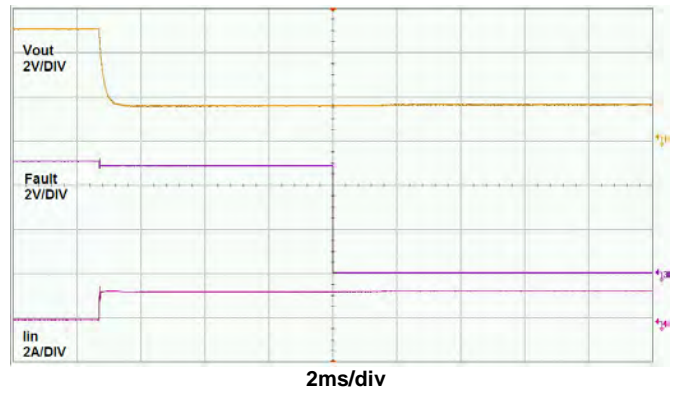

Figure 6. No Load to 1Ω Transient Response

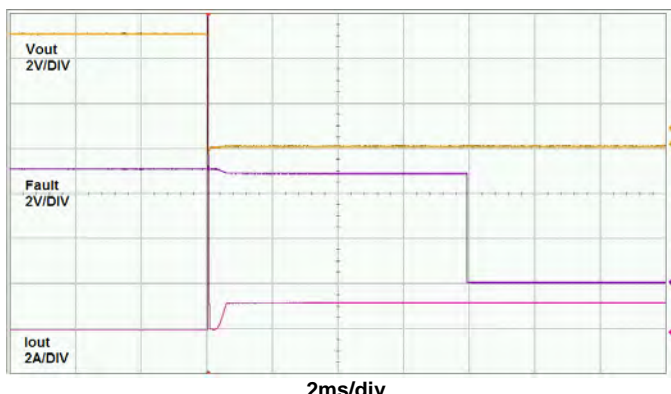

Figure 7. Short-Circuit Current Limit Response

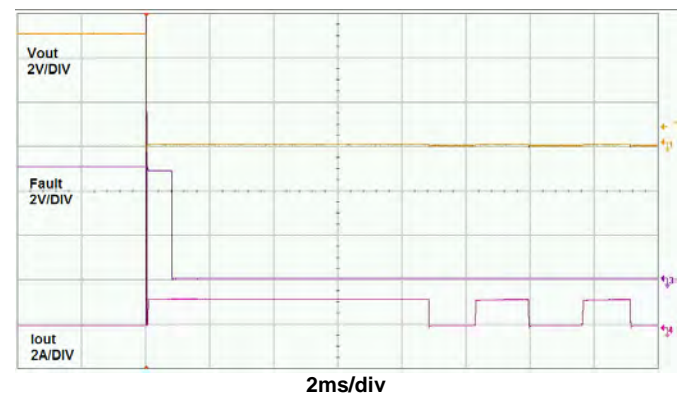

Figure 8. Extended Short-Circuit into Thermal Cycles

**Typical Performance Characteristics (cont.)**

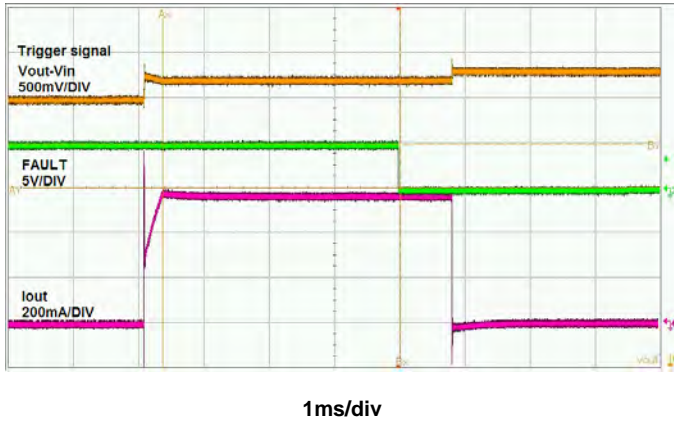

Figure 9. Reverse Current Limit Response(AP2552A/AP2553A)

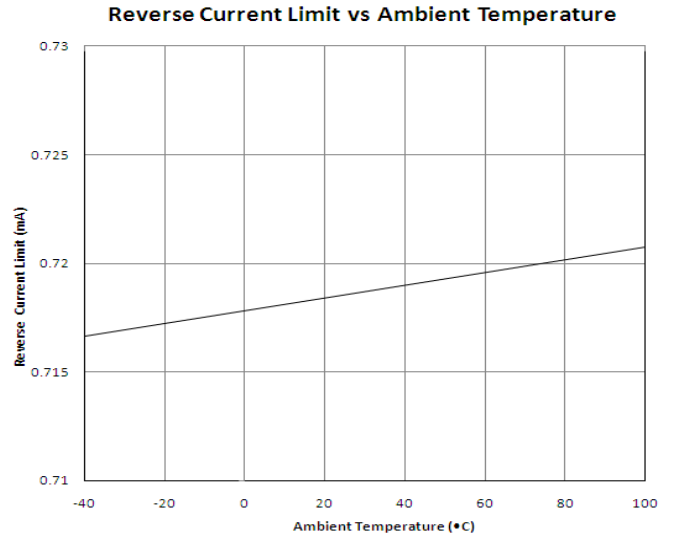

Figure 10. Reverse Current Limit vs. Ambient Temperature

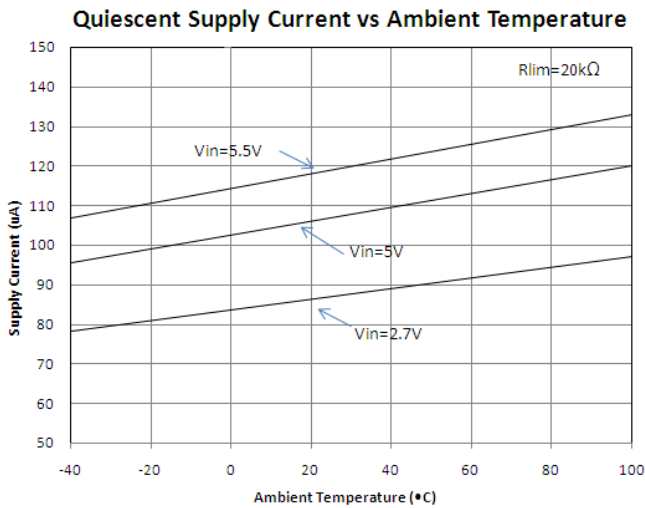

Figure 11. Quiescent Current vs. Ambient Temperature

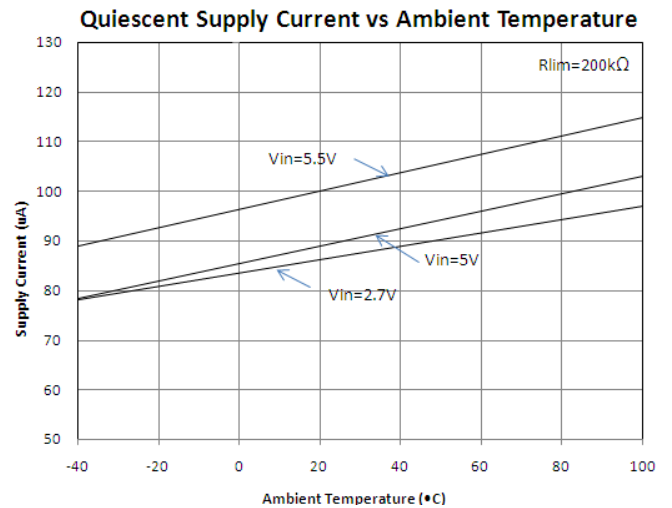

Figure 12. Quiescent Current vs. Ambient Temperature

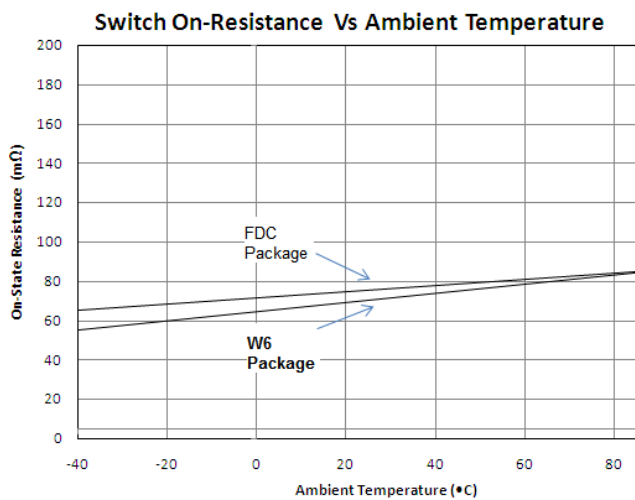

Figure 13. Switch On-Resistance vs. Ambient Temperature

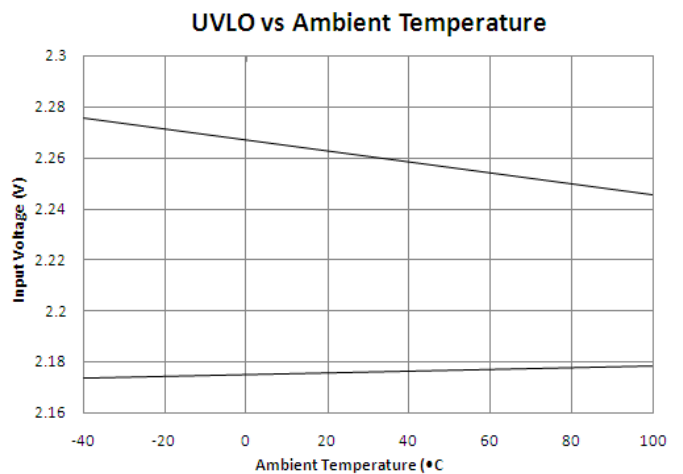

Figure 14. Under-Voltage Lock Out vs. Ambient Temperature



## Application Note

The AP2552/53 AND AP2552A/53A are integrated high-side power switches optimized for Universal Serial Bus (USB) that requires protection functions. The power switches are equipped with a driver that controls the gate voltage and incorporates slew-rate limitation. This, along with the various protection features and special functions, makes these power switches ideal for hot-swap or hot-plug applications.

### Protection Features:

#### Under-Voltage Lockout (UVLO)

Whenever the input voltage falls below UVLO threshold (~2.5V), the power switch is turned off. This facilitates the design of hot-insertion systems where it is not possible to turn off the power switch before input power is removed.

#### Over-Current and Short-Circuit Protection

An internal sensing FET is employed to check for over-current conditions. Unlike current-sense resistors, sense FETs do not increase the series resistance of the current path. When an overcurrent condition is detected, the device maintains a constant output current and reduces the output voltage accordingly. Complete shutdown occurs only if the fault stays long enough to activate thermal limiting.

The different overload conditions and the corresponding response of the AP2552/53 AND AP2552A/53A are outlined below:

S.NO	Conditions	Explanation	Behavior of the AP2552/53 AND AP2552A/53A
1	Short-circuit condition at start-up	Output is shorted before input voltage is applied or before the part is enabled	The IC senses the short circuit and immediately clamps output current to a certain safe level namely $I_{SHORT}$ .
2	Short-circuit or overcurrent condition	Short-Circuit or Overload condition that occurs when the part is enabled.	<ul style="list-style-type: none"> <li>At the instance the overload occurs, higher current may flow for a very short period of time before the current limit function can react.</li> <li>After the current limit function has tripped (reached the over-current trip threshold), the device switches into current limiting mode and the current is clamped at <math>I_{SHORT} / I_{LIMIT}</math>.</li> </ul>
3	Gradual increase from nominal operating current to $I_{LIMIT}$	Load increases gradually until the current-limit threshold. ( $I_{TRIG}$ )	The current rises until $I_{LIMIT}$ or thermal limit. Once the threshold has been reached, the device switches into its current limiting mode and is set at $I_{LIMIT}$ .

Note that when the output has been shorted to GND at extremely low temperature (< -30°C), a minimum 120- $\mu$ F electrolytic capacitor on the output pin is recommended. A correct capacitor type with capacitor voltage rating and temperature characteristics must be properly chosen so that capacitance value does not drop too low at the extremely low temperature operation. A recommended capacitor should have temperature characteristics of less than 10% variation of capacitance change when operated at extremely low temp. Our recommended aluminum electrolytic capacitor type is Panasonic FC series.

#### Current-Limit Threshold Programming

The current-limit threshold can be programmed using an external resistor. The current-limit threshold is proportional to the current sourced out of  $I_{LIM}$ .

The recommended 1% resistor range for  $R_{LIM}$  is  $10k\Omega \leq R_{LIM} \leq 210k\Omega$ . Figure 15 includes current-limit tolerance due to variations caused by temperature and process. This graph does not include the external resistor tolerance. The traces routing the  $R_{LIM}$  resistor to the AP2552/53 and AP2552A/53A should be as short as possible to reduce parasitic effects on the current-limit accuracy.

To design below a maximum current-limit threshold, find the intersection of  $R_{LIM}$  and the maximum desired load current on the  $I_{OS(max)}$  ( $I_{LIM}$ ) curve and choose a value of  $R_{LIM}$  above this value. Programming the current limit below a maximum threshold is important to avoid current limiting upstream power supplies causing the input voltage bus to droop. The resulting minimum current-limit threshold is the intersection of the selected value of  $R_{LIM}$  and the  $I_{OS(min)}$  ( $I_{LIM}$ ) curve.

**Application Note** (cont.)

**Current-Limit Threshold Programming** (cont.)

Current-Limit Threshold Equations ( $I_{LIM}$ ):

$$I_{LIM(MAX)}(mA) = \frac{20200}{R_{LIM}^{0.91} k\Omega}$$

$$I_{LIM(TYP)}(mA) = \frac{20620}{R_{LIM}^{0.94} k\Omega}$$

$$I_{LIM(MIN)}(mA) = \frac{20211}{R_{LIM}^{0.96} k\Omega}$$

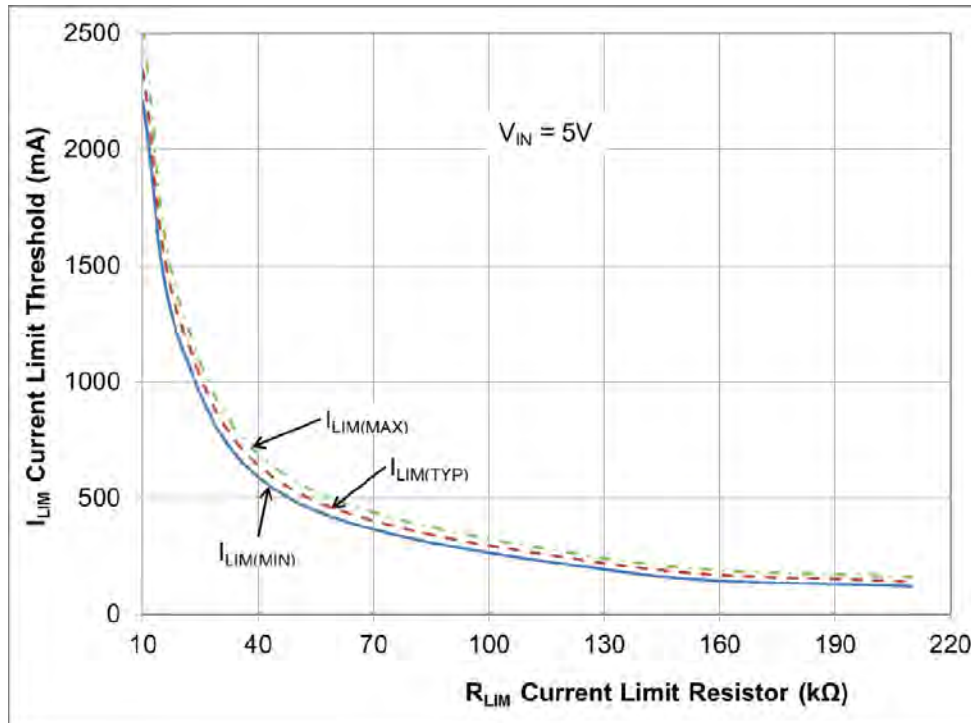

Figure 15. Current-Limit Threshold vs  $R_{LIM}$

**Thermal Protection**

Thermal protection prevents the IC from damage when the die temperature exceeds safe margins. This mainly occurs when heavy-overload or short-circuit faults are present for extended periods of time. The AP2552/53 AND AP2552A/53A implements a thermal sensing to monitor the operating junction temperature of the power distribution switch. Once the die temperature rises to approximately +160°C (140°C in case the part is under current limit), the thermal protection feature gets activated as follows: The internal thermal sense circuitry turns the power switch off and the FAULT output is asserted thus preventing the power switch from damage. Hysteresis in the thermal sense circuit allows the device to cool down by approximately +20°C before the output is turned back on. This built-in thermal hysteresis feature is an excellent feature, as it avoids undesirable oscillations of the thermal protection circuit. The switch continues to cycle in this manner until the load fault is removed, resulting in a pulsed output.

**Reverse-Current and Reverse-Voltage Protection**

The USB specification does not allow an output device to source current back into the USB port. In a normal MOSFET switch, current will flow in reverse direction (from the output side to the input side) when the output side voltage is higher than the input side. A reverse-current limit (ROCP) feature is implemented in the AP2552/53 AND AP2552A/53A to limit such back currents. The ROCP circuit is activated when the output voltage is higher than the input voltage. After the reverse current circuit has tripped (reached the reverse current trip threshold), the current is clamped at this IROCP level.

In addition to ROCP, reverse over-voltage protection (ROVP) is also implemented. The ROVP circuit is activated by the **reverse voltage comparator trip point** ie; the difference between the output voltage and the input voltage.

For AP2552/53, once ROVP is activated, FAULT assertion occurs at a de-glitch time of 4ms. Recovery from ROVP is automatic when the fault is removed. FAULT de-assertion de-glitch time is same as the de-assertion time.

## Application Note (cont.)

### Reverse-Current and Reverse-Voltage Protection (cont.)

For AP2552A/53A, once ROVP is activated and when the condition exists for more than 5ms (TYP), output device is disabled and shutdown. This is called the "Time from Reverse-Voltage Condition to MOSFET Turn Off". FAULT assertion occurs at a de-glitch time of 4ms after ROVP is reached. Recovery from this fault is achieved by recycling power or toggling EN. FAULT de-assertion de-glitch time is same as the de-assertion time.

### Special Functions:

#### Discharge Function

When enable is de-asserted, or when the input voltage is under UVLO level, the discharge function is active. The output capacitor is discharged through an internal NMOS that has a discharge resistance of 100Ω. Hence, the output voltage drops down to zero. The time taken for discharge is dependent on the RC time constant of the resistance and the output capacitor.

#### FAULT Response

The FAULT open-drain output goes active low for any of following faults: Current limit threshold, short-circuit current limit, reverse-voltage condition or thermal shutdown. The time from when a fault condition is encountered to when the FAULT output goes low is 7ms (TYP). The FAULT output remains low until over-current, short-circuit current limit and over-temperature conditions are removed. Connecting a heavy capacitive load to the output of the device can cause a momentary Over-current condition, which does not trigger the FAULT due to the 7ms deglitch timeout. This 7-ms timeout is also applicable for over-current recovery and over-temperature recovery. The AP2552/53 and AP2552-2/53A are designed to eliminate erroneous over-current reporting without the need for external components, such as an RC delay network.

For the AP2552/53 and AP2552A/53A when the reverse voltage condition is triggered, FAULT output goes low after 4ms (TYP). This 4ms (TYP) timeout is also applicable for the recovery from reverse voltage fault.

When the ILIM pin is shorted to IN or GND, current-limit threshold and short-circuit current limit will be clamped at typically 75mA. When the ILIM pin is shorted to IN or GND the AP2552/53 and AP2552A/53A FAULT pin will not assert during current limiting conditions; The FAULT pin will assert during short circuit conditions.

#### Power Supply Considerations

A 0.01-μF to 0.1-μF X7R or X5R ceramic bypass capacitor between IN and GND, close to the device, is recommended. This limits the input voltage drop during line transients. Placing a high-value electrolytic capacitor on the input (10μF minimum) and output pin(120μF) is recommended when the output load is heavy. This precaution also reduces power-supply transients that may cause ringing on the input. Additionally, bypassing the device output with a 0.1μF to 4.7μF ceramic capacitor improves the immunity of the device to short-circuit transients. This capacitor also prevents output from going negative during turn-off due to parasitic inductance.

#### Power Dissipation and Junction Temperature

The low on-resistance of the internal MOSFET allows the small surface-mount packages to pass large current. Using the maximum operating ambient temperature ( $T_A$ ) and  $R_{DS(ON)}$ , the power dissipation can be calculated by:

$$P_D = R_{DS(ON)} \times I^2$$

Finally, calculate the junction temperature:

$$T_J = P_D \times \theta_{JA} + T_A$$

Where:

$T_A$  = Ambient temperature °C

$\theta_{JA}$  = Thermal resistance

$P_D$  = Total power dissipation

#### Generic Hot-Plug Applications

In many applications it may be necessary to remove modules or pc boards while the main unit is still operating. These are considered hot-plug applications. Such implementations require the control of current surges seen by the main power supply and the card being inserted. The most effective way to control these surges is to limit and slowly ramp the current and voltage being applied to the card, similar to the way in which a power supply normally turns on. Due to the controlled rise times and fall times of the AP2552/53 AND AP2552A/53A, these devices can be used to provide a softer start-up to devices being hot-plugged into a powered system. The UVLO feature of the AP2552/53 AND AP2552A/53A also ensures that the switch is off after the card has been removed, and that the switch is off during the next insertion.

## Application Note (cont.)

### Generic Hot-Plug Applications

By placing the AP2552/53 AND AP2552A/53A between the V<sub>CC</sub> input and the rest of the circuitry, the input power reaches these devices first after insertion. The typical rise time of the switch is approximately 1ms, providing a slow voltage ramp at the output of the device. This implementation controls system surge current and provides a hot-plugging mechanism for any device.

## Ordering Information

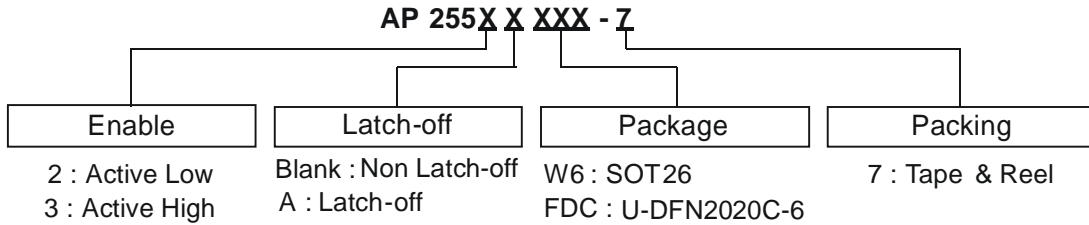

Part Number	Enable Active	Output Fault Condition	Package Code	Packaging	7" Tape and Reel	
					Quantity	Part Number Suffix
AP2552W6-7	Low	Output Current Limits	W6	SOT26	3000/Tape & Reel	-7
AP2552FDC-7			FDC	U-DFN2020C-6	3000/Tape & Reel	-7
AP2553W6-7	High		W6	SOT26	3000/Tape & Reel	-7
AP2553FDC-7			FDC	U-DFN2020C-6	3000/Tape & Reel	-7
AP2552AW6-7	Low	Output Latches Off	W6	SOT26	3000/Tape & Reel	-7
AP2552AFDC-7			FDC	U-DFN2020C-6	3000/Tape & Reel	-7
AP2553AW6-7	High		W6	SOT26	3000/Tape & Reel	-7
AP2553AFDC-7			FDC	U-DFN2020C-6	3000/Tape & Reel	-7

## Marking Information

(1) SOT26

( Top View )

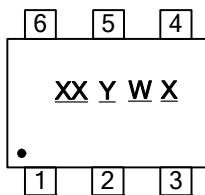

**XX** : Identification Code  
**Y** : Year 0~9  
**W** : Week : A~Z : 1~26 week;  
           a~z : 27~52 week; z represents  
           52 and 53 week  
**X** : Internal Code

Device	Package	Identification Code
AP2552W6	SOT26	BJ
AP2553W6	SOT26	BK
AP2552AW6	SOT26	BM
AP2553AW6	SOT26	BN

**Marking Information** (cont.)

(2) U-DFN2020C-6

**( Top View )**

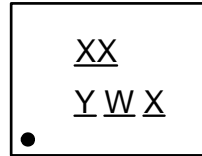

XX : Identification Code  
Y : Year : 0~9  
W : Week : A~Z : 1~26 week;  
a~z : 27~52 week; z represents  
52 and 53 week  
X : Internal Code

Device	Package	Identification Code
AP2552FDC	U-DFN2020C-6	BJ
AP2553FDC	U-DFN2020C-6	BK
AP2552AFDC	U-DFN2020C-6	BM
AP2553AFDC	U-DFN2020C-6	BN

**Package Outline Dimensions** (All dimensions in mm.)

Please see AP02002 at <http://www.diodes.com/datasheets/ap02002.pdf> for latest version.

(1) Package Type: SOT26

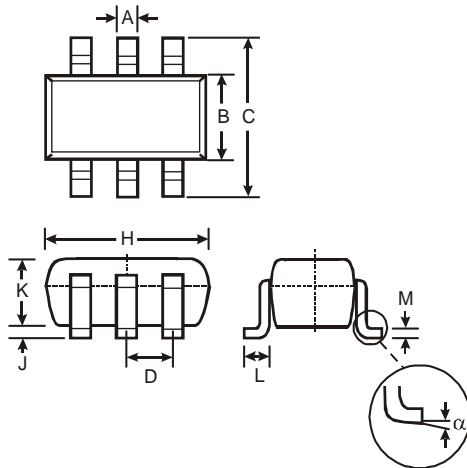

SOT26			
Dim	Min	Max	Typ
A	0.35	0.50	0.38
B	1.50	1.70	1.60
C	2.70	3.00	2.80
D	—	—	0.95
H	2.90	3.10	3.00
J	0.013	0.10	0.05
K	1.00	1.30	1.10
L	0.35	0.55	0.40
M	0.10	0.20	0.15
α	0°	8°	—
All Dimensions in mm			

(2) Package Type: U-DFN2020-6

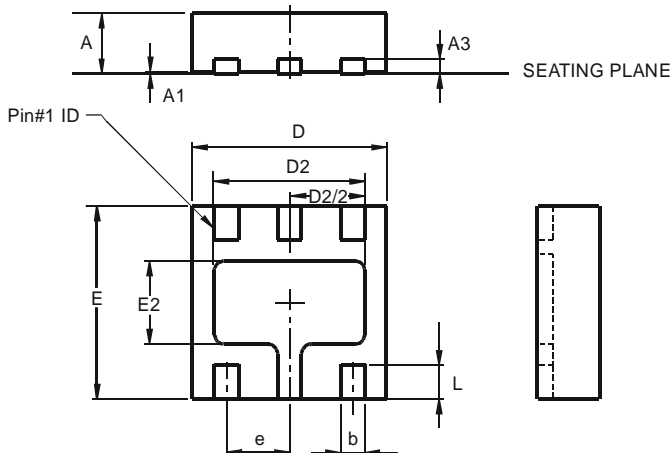

U-DFN2020-6			
Dim	Min	Max	Typ
A	0.57	0.63	0.60
A1	0	0.05	0.03
A3	—	—	0.15
b	0.20	0.30	0.25
D	1.95	2.075	2.00
D2	1.45	1.65	1.55
e	—	—	0.65
E	1.95	2.075	2.00
E2	0.76	0.96	0.86
L	0.30	0.40	0.35
All Dimensions in mm			

**Suggested Pad Layout**

Please see AP02001 at <http://www.diodes.com/datasheets/ap02001.pdf> for the latest version.

(1) Package Type: SOT26

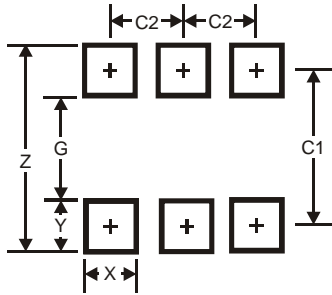

Dimensions	Value (in mm)
Z	3.20
G	1.60
X	0.55
Y	0.80
C1	2.40
C2	0.95

(2) Package Type: U-DFN2020-6

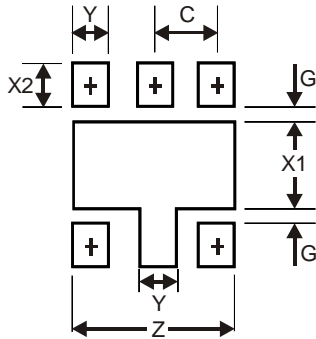

Dimensions	Value (in mm)
Z	1.67
G	0.15
X1	0.90
X2	0.45
Y	0.37
C	0.65

**Taping Orientation** (Note 11)

(1) Package Type: SOT26

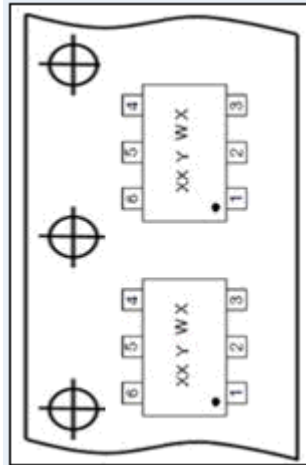

(2) Package Type: U-DFN2020-6

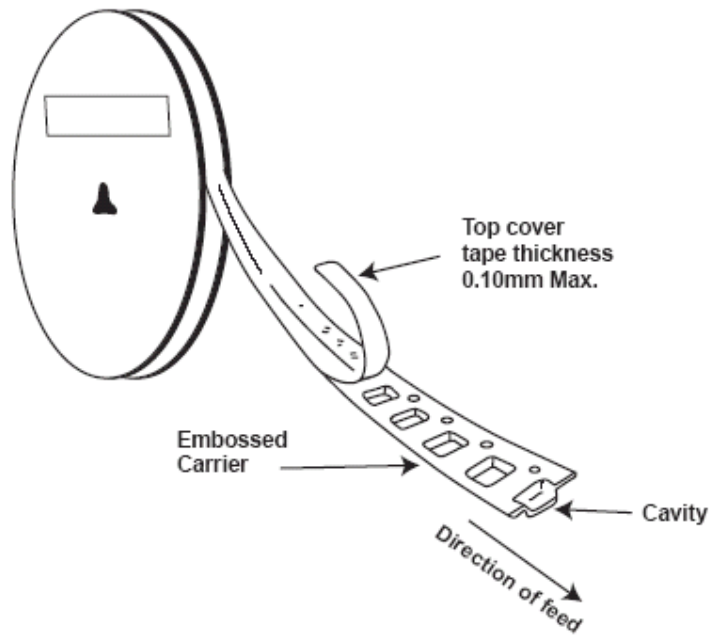
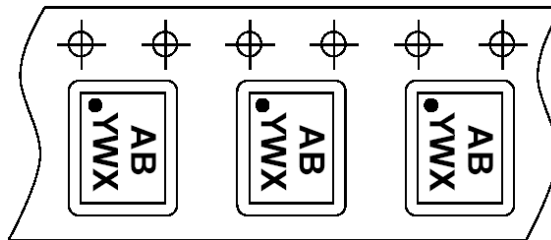

Notes: 11. The taping orientation of the other package type can be found on our website at <http://www.diodes.com/datasheets/ap02007.pdf>

**IMPORTANT NOTICE**

DIODES INCORPORATED MAKES NO WARRANTY OF ANY KIND, EXPRESS OR IMPLIED, WITH REGARDS TO THIS DOCUMENT, INCLUDING, BUT NOT LIMITED TO, THE IMPLIED WARRANTIES OF MERCHANTABILITY AND FITNESS FOR A PARTICULAR PURPOSE (AND THEIR EQUIVALENTS UNDER THE LAWS OF ANY JURISDICTION).

Diodes Incorporated and its subsidiaries reserve the right to make modifications, enhancements, improvements, corrections or other changes without further notice to this document and any product described herein. Diodes Incorporated does not assume any liability arising out of the application or use of this document or any product described herein; neither does Diodes Incorporated convey any license under its patent or trademark rights, nor the rights of others. Any Customer or user of this document or products described herein in such applications shall assume all risks of such use and will agree to hold Diodes Incorporated and all the companies whose products are represented on Diodes Incorporated website, harmless against all damages.

Diodes Incorporated does not warrant or accept any liability whatsoever in respect of any products purchased through unauthorized sales channel. Should Customers purchase or use Diodes Incorporated products for any unintended or unauthorized application, Customers shall indemnify and hold Diodes Incorporated and its representatives harmless against all claims, damages, expenses, and attorney fees arising out of, directly or indirectly, any claim of personal injury or death associated with such unintended or unauthorized application.

Products described herein may be covered by one or more United States, international or foreign patents pending. Product names and markings noted herein may also be covered by one or more United States, international or foreign trademarks.

This document is written in English but may be translated into multiple languages for reference. Only the English version of this document is the final and determinative format released by Diodes Incorporated.

**LIFE SUPPORT**

Diodes Incorporated products are specifically not authorized for use as critical components in life support devices or systems without the express written approval of the Chief Executive Officer of Diodes Incorporated. As used herein:

A. Life support devices or systems are devices or systems which:

1. are intended to implant into the body, or
2. support or sustain life and whose failure to perform when properly used in accordance with instructions for use provided in the labeling can be reasonably expected to result in significant injury to the user.

B. A critical component is any component in a life support device or system whose failure to perform can be reasonably expected to cause the failure of the life support device or to affect its safety or effectiveness.

Customers represent that they have all necessary expertise in the safety and regulatory ramifications of their life support devices or systems, and acknowledge and agree that they are solely responsible for all legal, regulatory and safety-related requirements concerning their products and any use of Diodes Incorporated products in such safety-critical, life support devices or systems, notwithstanding any devices- or systems-related information or support that may be provided by Diodes Incorporated. Further, Customers must fully indemnify Diodes Incorporated and its representatives against any damages arising out of the use of Diodes Incorporated products in such safety-critical, life support devices or systems.

Copyright © 2012, Diodes Incorporated

[www.diodes.com](http://www.diodes.com)



## Данный компонент на территории Российской Федерации

### Вы можете приобрести в компании MosChip.

Для оперативного оформления запроса Вам необходимо перейти по данной ссылке:

<http://moschip.ru/get-element>

Вы можете разместить у нас заказ для любого Вашего проекта, будь то серийное производство или разработка единичного прибора.

В нашем ассортименте представлены ведущие мировые производители активных и пассивных электронных компонентов.

Нашей специализацией является поставка электронной компонентной базы двойного назначения, продукции таких производителей как XILINX, Intel (ex.ALTERA), Vicor, Microchip, Texas Instruments, Analog Devices, Mini-Circuits, Amphenol, Glenair.

Сотрудничество с глобальными дистрибьюторами электронных компонентов, предоставляет возможность заказывать и получать с международных складов практически любой перечень компонентов в оптимальные для Вас сроки.

На всех этапах разработки и производства наши партнеры могут получить квалифицированную поддержку опытных инженеров.

Система менеджмента качества компании отвечает требованиям в соответствии с ГОСТ Р ИСО 9001, ГОСТ РВ 0015-002 и ЭС РД 009

### Офис по работе с юридическими лицами:

105318, г.Москва, ул.Щербаковская д.3, офис 1107, 1118, ДЦ «Щербаковский»

Телефон: +7 495 668-12-70 (многоканальный)

Факс: +7 495 668-12-70 (доб.304)

E-mail: [info@moschip.ru](mailto:info@moschip.ru)

Skype отдела продаж:

moschip.ru

moschip.ru\_4

moschip.ru\_6

moschip.ru\_9