

LOC		DIST		REVISIONS			
P	LR	DESCRIPTION	DATE	DWN	APVD	REV	AA2
AD	00	AA2	REVISED PER ECO-11-004917	11MAR11	RK	HMR	

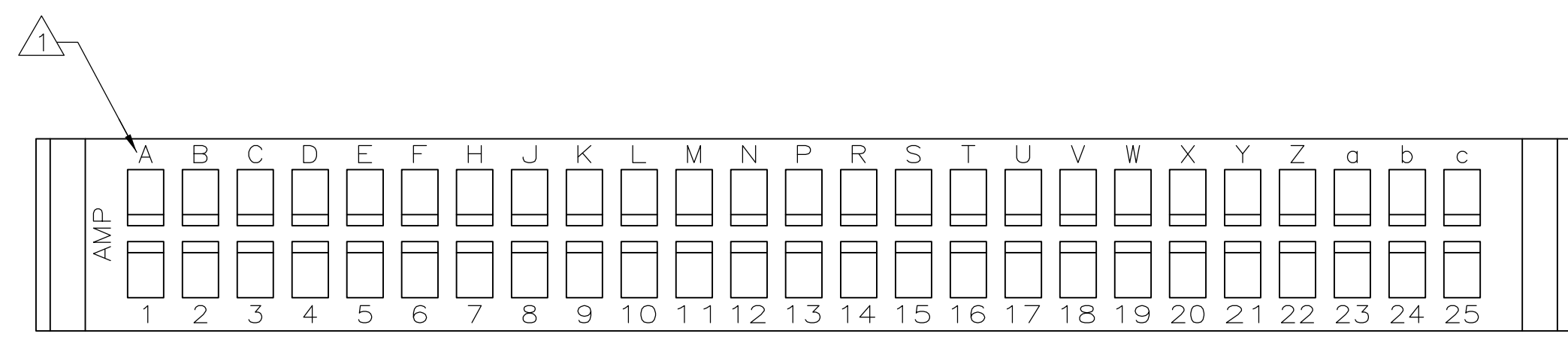

THIS DRAWING IS A CONTROLLED DOCUMENT FOR AMP INCORPORATED. IT IS SUBJECT TO CHANGE AND THE CONTROLLING ENGINEERING ORGANIZATION SHOULD BE CONTACTED FOR THE LATEST REVISION.

THIS DRAWING IS A CONTROLLED DOCUMENT.		DWN J. GALLUCCI BG 12-10-92		CHK H. ROSE 2/18/94		APVD H. ROSE 2/18/94		NAME		STE TE Connectivity	
DIMENSIONS: MM(INCHES)		TOLERANCES UNLESS OTHERWISE SPECIFIED:		PRODUCT SPEC		APPLICATION SPEC		WEIGHT		SIZE CAGE CODE DRAWING NO	
0 PLC ± -		1 PLC ± -		2 PLC ± -		3 PLC ± 0.13(.005)		4 PLC ± -		A1 00779 C=583717	
MATERIAL: GLASS FILLED POLYESTER		FINISH: -		CUSTOMER DRAWING		SCALE: 4:1		SHEET 1 OF 2		REV AA2	

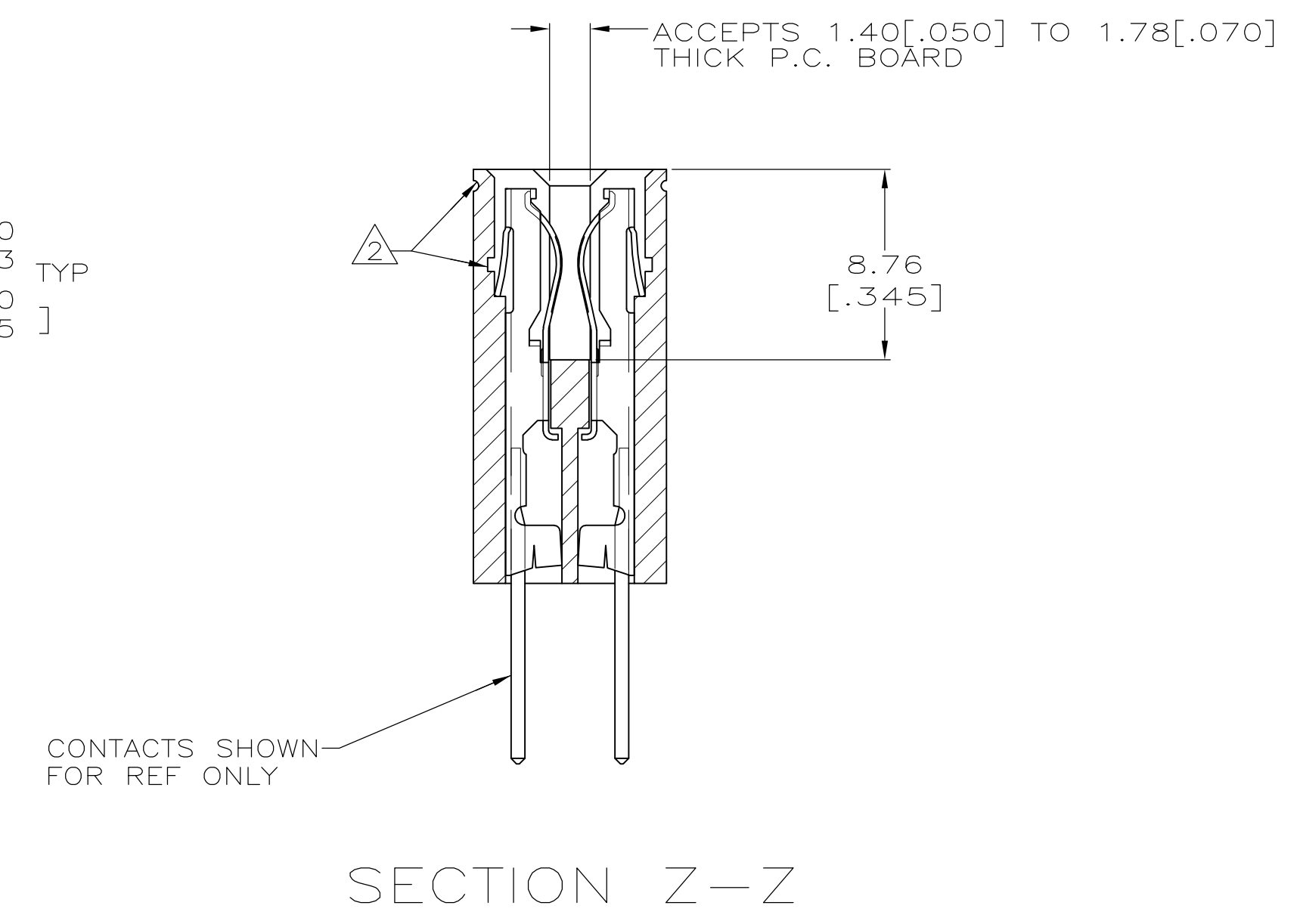
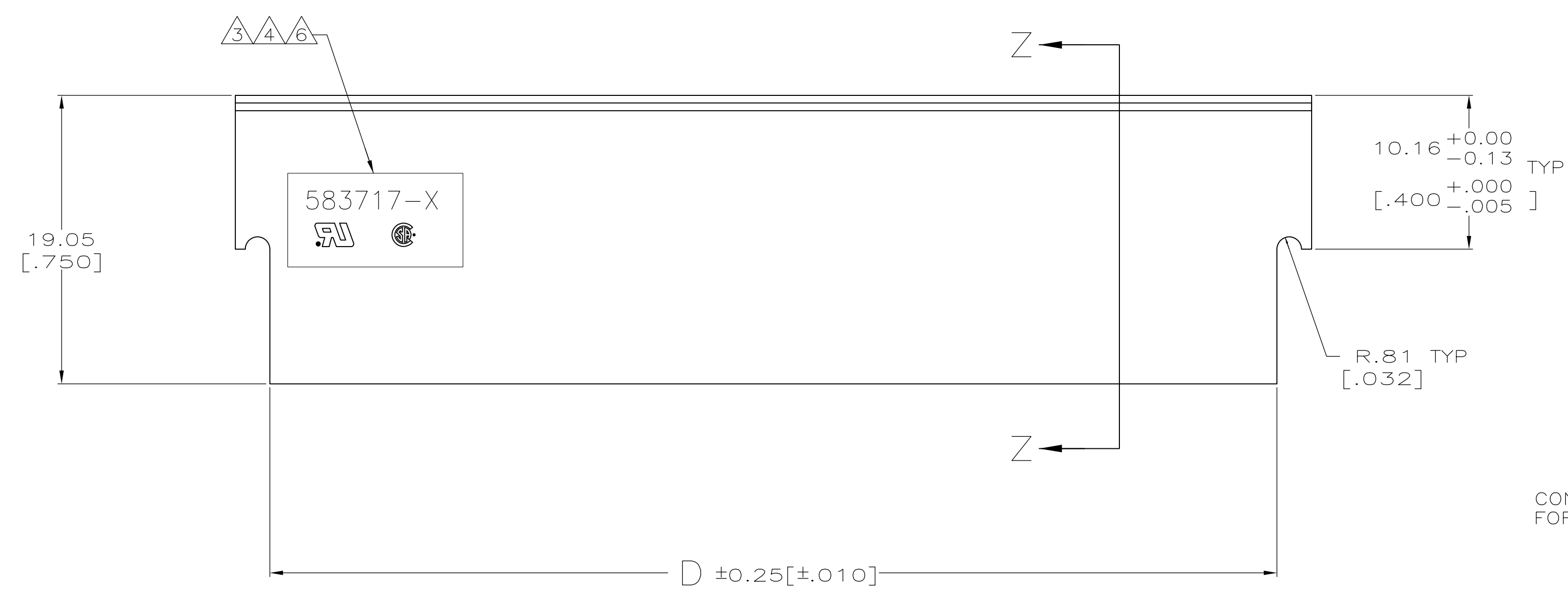
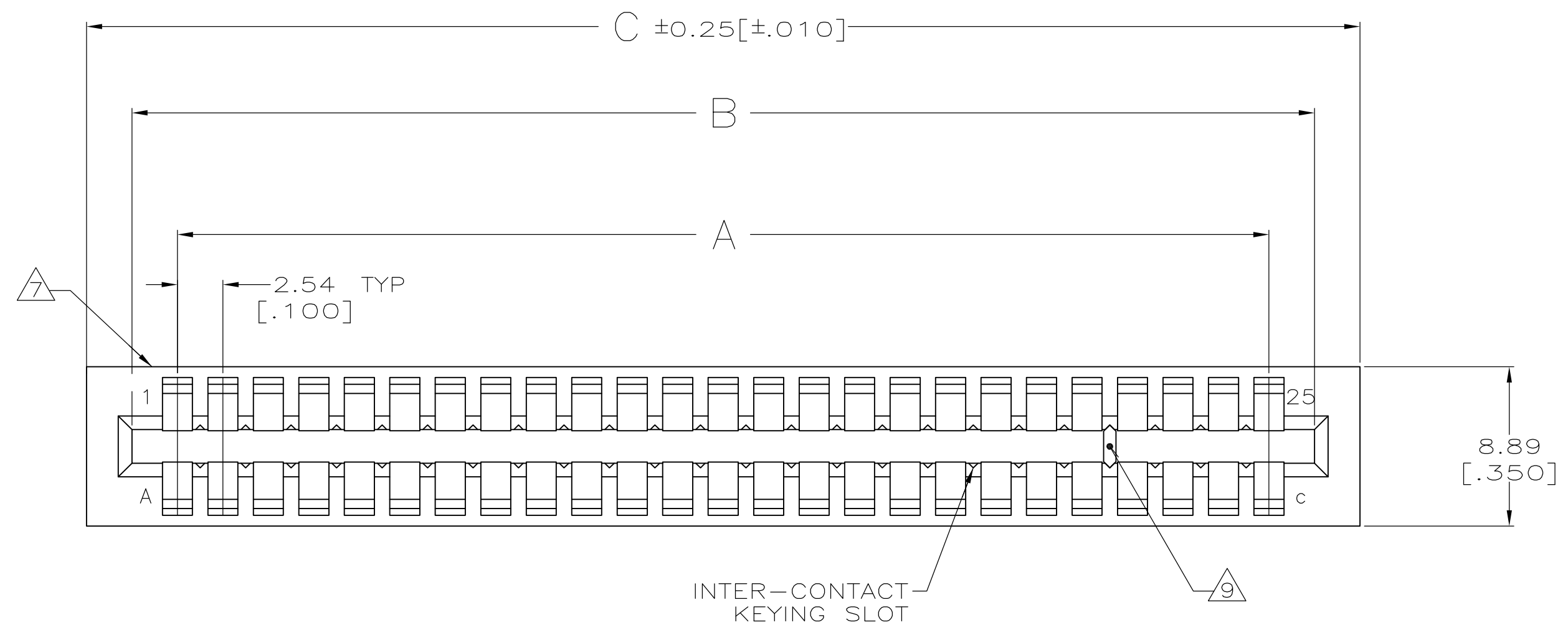
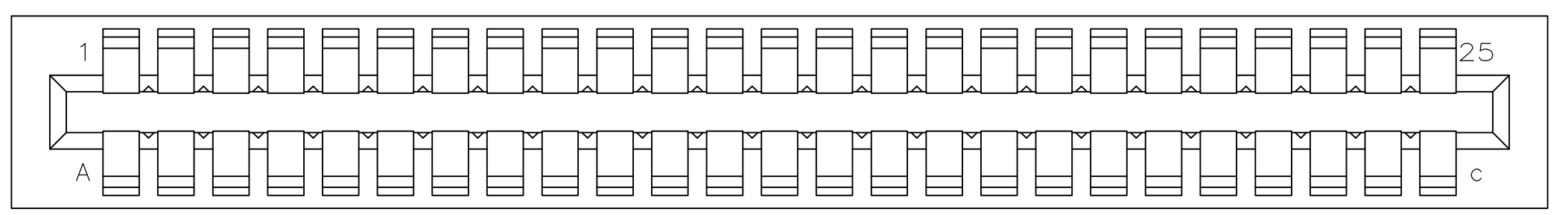
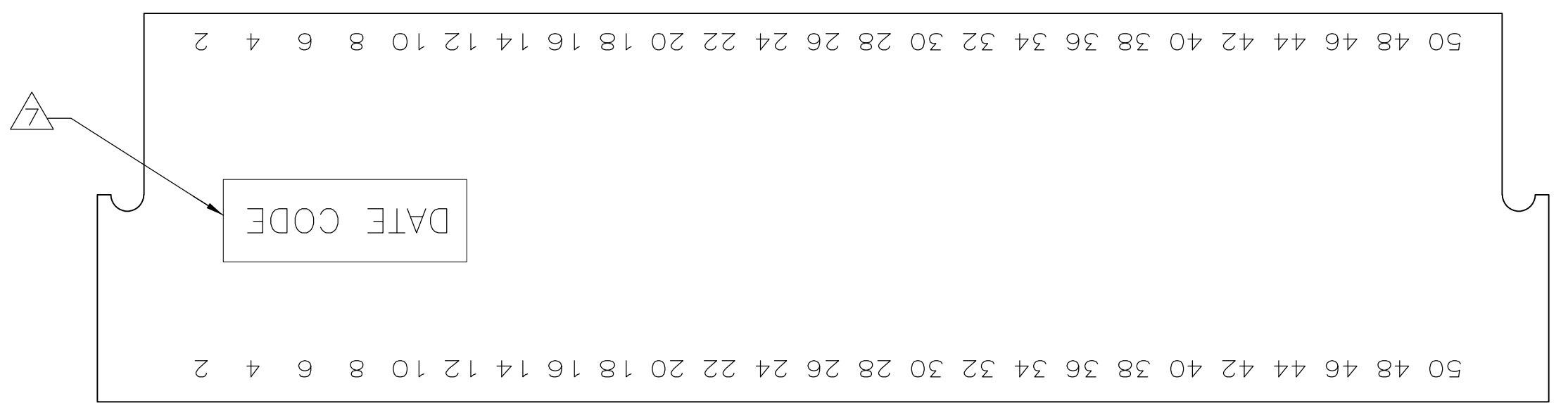
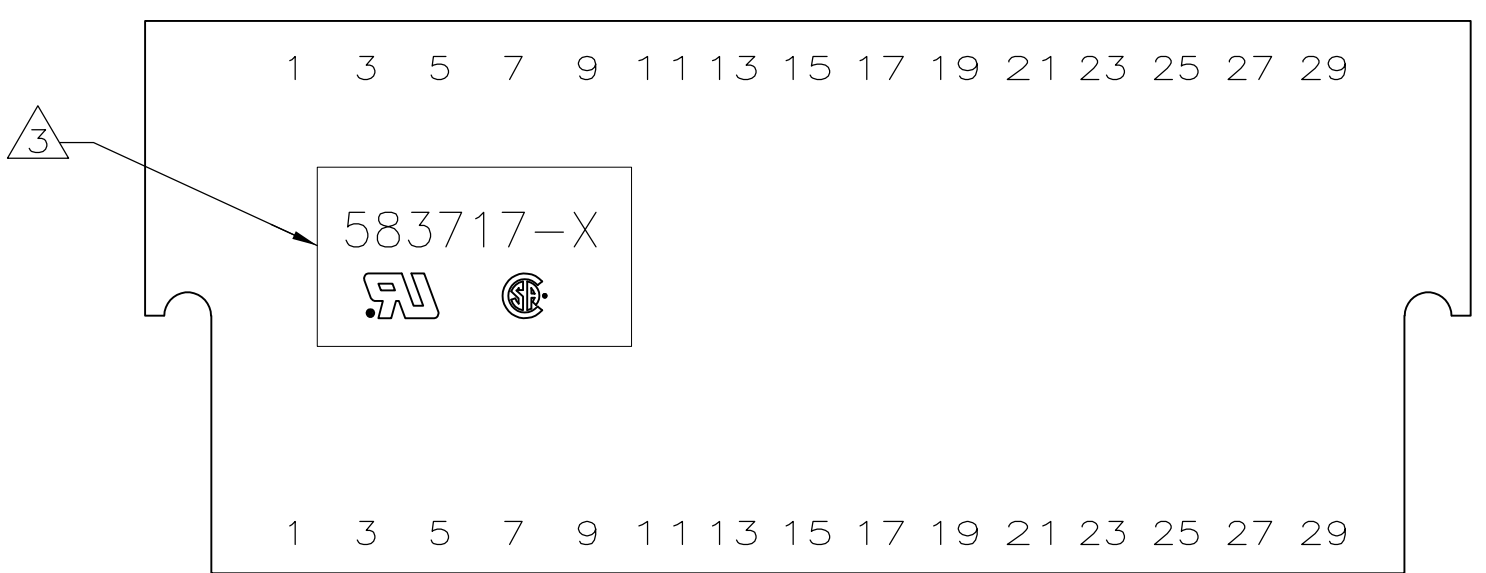
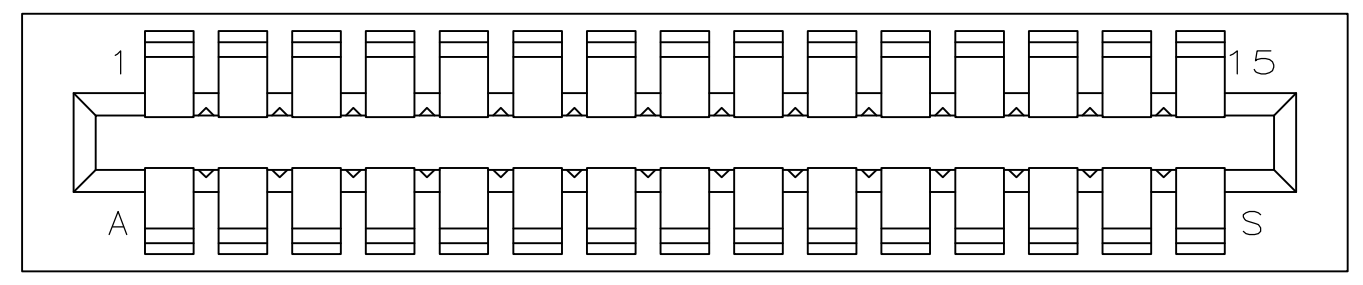
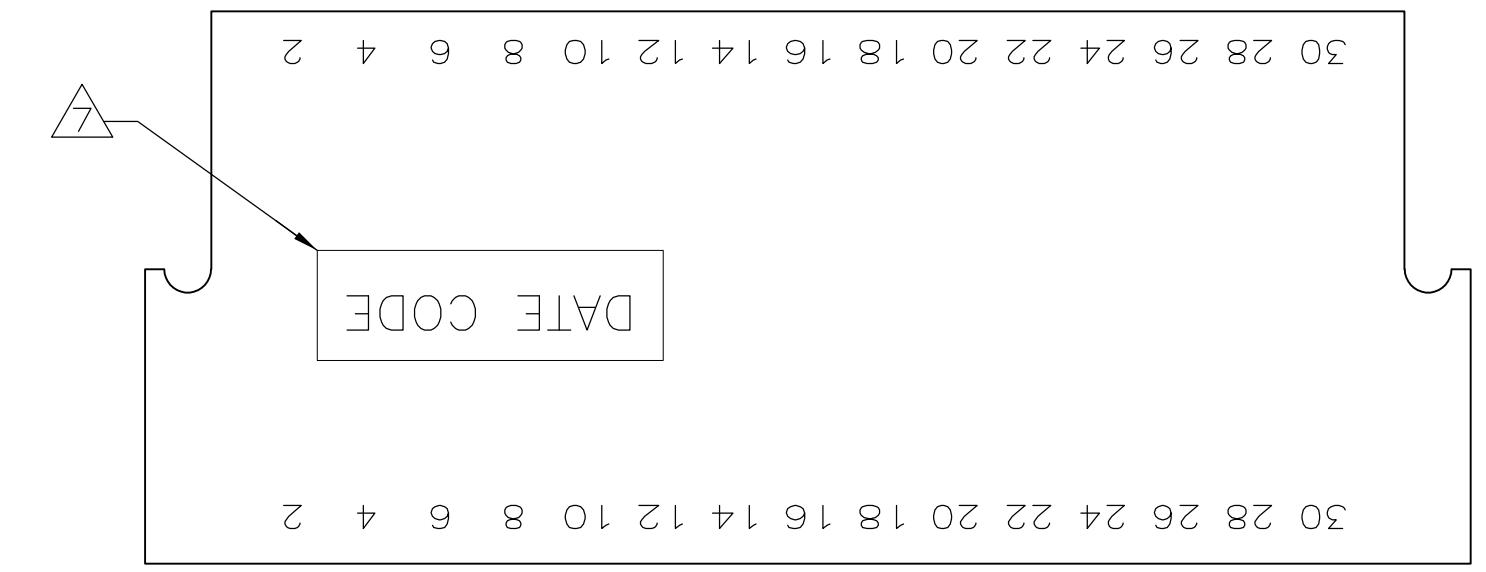

3-583717-4

- 1 FIRST 22 POSITIONS MARKED WITH UPPER CASE LETTERS, FOLLOWED BY LOWER CASE LETTERS, FOLLOWED BY UPPERCASE AA,AB,AC ETC. CHARACTERS G,I,O AND Q ARE OMITTED. SEE TABLE FOR END CAVITY IDENTIFICATION.
- 2 OPTIONAL PULL GROOVES. THE PULL GROOVE LENGTH, SIZE AND LOCATION ARE AT THE DISCRETION OF THE MOLD VENDOR.
- 3 HOUSING PART NUMBER, UL & CSA LOGO'S TO BE MOLDED IN THIS AREA. UL, LOGO PER 1-18838-3, CSA LOGO PER 1-18839-3.
- 4 HOT STAMP CUSTOMER PART NUMBER 2571 0880 FOR 2-583717-9 ONLY.
- 5 HOT STAMP CUSTOMER PART NUMBER 655862-2 IN THIS AREA.
- 6 DATE CODE TO BE MOLDED IN THIS AREA
- 7 MOLDED KEYING PLUG LOCATED BETWEEN CIRCUITS 25 AND 26 FOR PART NUMBER 4-583717-6 ONLY.
- 8 PRELIMINARY - NOT RELEASED FOR PRODUCTION.

3 & C	10.67 [.420]	15.24 [.600]	10.16 [.400]	5.08 [.200]	3	4-583717-8	
23 & A	61.47 [2.420]	66.04 [2.600]	60.96 [2.400]	55.88 [2.200]	23	4-583717-7	
30 & J	79.25 [3.120]	83.82 [3.300]	78.74 [3.100]	73.66 [2.900]	30	4-583717-6	
27 & E	71.63 [2.820]	76.20 [3.000]	71.12 [2.800]	66.04 [2.600]	27	4-583717-5	
8 & J	23.37 [.920]	27.94 [1.100]	22.86 [.900]	17.78 [.700]	8	3-583717-9	
OBSOLETE	13 & P	36.07 [1.420]	40.64 [1.600]	35.56 [1.400]	30.48 [1.200]	13	3-583717-8
OBSOLETE	25 & e	66.55 [2.620]	71.12 [2.800]	66.04 [2.600]	60.96 [2.400]	25	3-583717-5
OBSOLETE	15 & S	41.15 [1.620]	45.72 [1.800]	40.64 [1.600]	35.56 [1.400]	15	3-583717-4
	13 & P	36.07 [1.420]	40.64 [1.600]	35.56 [1.400]	30.48 [1.200]	13	3-583717-3
	20 & X	53.85 [2.120]	58.42 [2.300]	53.34 [2.100]	48.26 [1.900]	20	3-583717-1
OBSOLETE	15 & S	41.15					
	14 & R	38.61					
OBSOLETE	28 & f	74.17					
	7 & H	20.83 [.820]					
	6 & F	18.29 [.720]					
	50 & AF	130.05					
OBSOLETE	40 & v	104.65					
	30 & j	79.25					
	25 & c	66.55					
		[2.320]	[2.500]	[2.300]	[2.100]		
	18 & V	48.77 [1.920]	53.34 [2.100]	48.26 [1.900]	43.18 [1.700]	18	583717-7
	17 & U	46.23 [1.820]	50.80 [2.000]	45.72 [1.800]	40.64 [1.600]	17	583717-5
	15 & S	41.15 [1.620]	45.72 [1.800]	40.64 [1.600]	35.56 [1.400]	15	583717-3
	10 & L	28.45 [1.120]	33.02 [1.300]	27.94 [1.100]	22.86 [.900]	10	583717-1
	END CAVITY IDENT	D	C	B	A	POSN	PART NUMBER

3-583717-5

THIS DRAWING IS A CONTROLLED DOCUMENT FOR AMP INCORPORATED. IT IS SUBJECT TO CHANGE AND THE CONTROLLING ENGINEERING ORGANIZATION SHOULD BE CONTACTED FOR THE LATEST REVISION.

THIS DRAWING IS A CONTROLLED DOCUMENT.		OWN: J. GALLUCCI 12-10-92 CHK: H. ROSE 2/18/94		PART NO	
DIMENSIONS: MM(INCHES)		TOLERANCES UNLESS OTHERWISE SPECIFIED:		STE TE Connectivity	
0 PLC ± .05 2 PLC ± .03 3 PLC ± .02 4 PLC ± .01 ANGLES ± .5		APVD: H. ROSE 2/18/94		NAME: HOUSING, CRIMP SNAP TWIN LEAF, .100 CL WITHOUT MOUNTING EARS	
MATERIAL: -		FINISH: -		SIZE: A1 CAGE CODE: 00779 DRAWING NO: 583717	
		WEIGHT: -		SCALE: 4:1 SHEET 2 OF 2 REV: AA2	
		CUSTOMER DRAWING			

Данный компонент на территории Российской Федерации

Вы можете приобрести в компании MosChip.

Для оперативного оформления запроса Вам необходимо перейти по данной ссылке:

<http://moschip.ru/get-element>

Вы можете разместить у нас заказ для любого Вашего проекта, будь то серийное производство или разработка единичного прибора.

В нашем ассортименте представлены ведущие мировые производители активных и пассивных электронных компонентов.

Нашей специализацией является поставка электронной компонентной базы двойного назначения, продукции таких производителей как XILINX, Intel (ex.ALTERA), Vicor, Microchip, Texas Instruments, Analog Devices, Mini-Circuits, Amphenol, Glenair.

Сотрудничество с глобальными дистрибьюторами электронных компонентов, предоставляет возможность заказывать и получать с международных складов практически любой перечень компонентов в оптимальные для Вас сроки.

На всех этапах разработки и производства наши партнеры могут получить квалифицированную поддержку опытных инженеров.

Система менеджмента качества компании отвечает требованиям в соответствии с ГОСТ Р ИСО 9001, ГОСТ РВ 0015-002 и ЭС РД 009

Офис по работе с юридическими лицами:

105318, г.Москва, ул.Щербаковская д.3, офис 1107, 1118, ДЦ «Щербаковский»

Телефон: +7 495 668-12-70 (многоканальный)

Факс: +7 495 668-12-70 (доб.304)

E-mail: info@moschip.ru

Skype отдела продаж:

moschip.ru

moschip.ru_4

moschip.ru_6

moschip.ru_9