

Low Input Current, Phototransistor Output, SOP-4, Mini-Flat Package

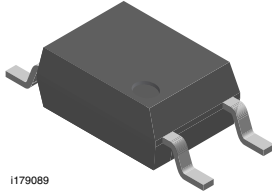

I179089

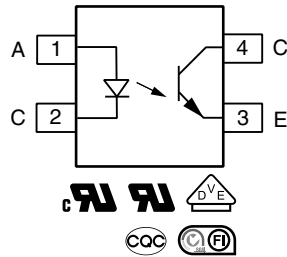

FEATURES

- Operating temperature from - 55 °C to + 110 °C
- SOP-4 mini-flat package
- Isolation test voltage, 3750 V_{RMS}
- Low saturation voltage
- Fast switching times
- Low coupling capacitance
- End-stackable, 0.100" (2.54 mm) spacing
- CTR range 40 % to 600 %, I_F = 5 mA
- Material categorization: For definitions of compliance please see www.vishay.com/doc?99912



DESCRIPTION

The 110 °C rated VOM617A has a GaAs infrared emitting diode emitter, which is optically coupled to a silicon planar phototransistor detector, and is incorporated in a 4 pin 100 mil lead pitch miniflat package. It features a high current transfer ratio, low coupling capacitance, and high isolation voltage.

These coupling devices are designed for signal transmission between two electrically separated circuits.

AGENCY APPROVALS

(All parts are certified under base model VOM617A)

- UL1577, file no. E52744
- cUL tested to CSA 22.2 bulletin 5A
- DIN EN 60747-5-5 (VDE 0884-5), available with option 1
- FIMKO EN 60065 and EN 60950-1
- CQC GB8898-2011, GB4943.1-2001

APPLICATIONS

- PLCs
- Telecommunication
- Lighting control system
- Solar inverters
- AC drives

ORDERING INFORMATION

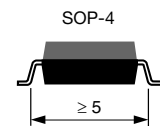
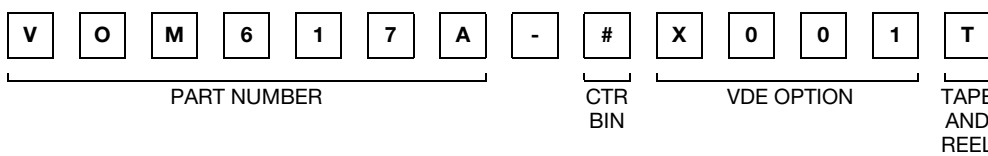

AGENCY CERTIFIED/ PACKAGE	CTR (%)							
	5 mA							
UL, cUL, FIMKO, CQC	50 to 600	63 to 125	100 to 200	160 to 320	250 to 500	80 to 160	130 to 260	200 to 400
SOP-4, mini-flat	VOM617AT	VOM617A-2T	VOM617A-3T	VOM617A-4T	VOM617A-6T	VOM617A-7T	VOM617A-8T	VOM617A-9T
VDE, UL, cUL, FIMKO, CQC	50 to 600	63 to 125	100 to 200	160 to 320	250 to 500	80 to 160	130 to 260	200 to 400
SOP-4, mini-flat	VOM617A-X001T	VOM617A-2X001T	VOM617A-3X001T	VOM617A-4X001T	VOM617A-6X001T	VOM617A-7X001T	VOM617A-8X001T	VOM617A-9X001T

ABSOLUTE MAXIMUM RATINGS ($T_{amb} = 25\text{ }^{\circ}\text{C}$, unless otherwise specified)				
PARAMETER	TEST CONDITION	SYMBOL	VALUE	UNIT
INPUT				
DC forward current		I_F	60	mA
Reverse voltage		V_R	6	V
Power dissipation		P_{diss}	70	mW
Surge forward current	$t_p \leq 10\text{ }\mu\text{s}$	I_{FSM}	2.5	A
OUTPUT				
Collector emitter voltage		V_{CEO}	80	V
Emitter collector voltage		V_{ECO}	7	V
Collector current		I_C	50	mA
	$t_p \leq 1\text{ ms}$		100	mA
Power dissipation		P_{diss}	150	mW
COUPLER				
Isolation test voltage between emitter and detector	$t = 1\text{ min}$	V_{ISO}	3750	V_{RMS}
Total power dissipation		P_{tot}	170	mW
Operating temperature range		T_{amb}	- 55 to + 110	$^{\circ}\text{C}$
Storage temperature range		T_{stg}	- 55 to + 150	$^{\circ}\text{C}$
Junction temperature		T_j	125	$^{\circ}\text{C}$
Soldering temperature ⁽¹⁾		T_{sld}	260	$^{\circ}\text{C}$

Notes

- Stresses in excess of the absolute maximum ratings can cause permanent damage to the device. Functional operation of the device is not implied at these or any other conditions in excess of those given in the operational sections of this document. Exposure to absolute maximum ratings for extended periods of the time can adversely affect reliability.

⁽¹⁾ See "Assembly Instructions" for surface mounted devices (www.vishay.com/doc?80054).

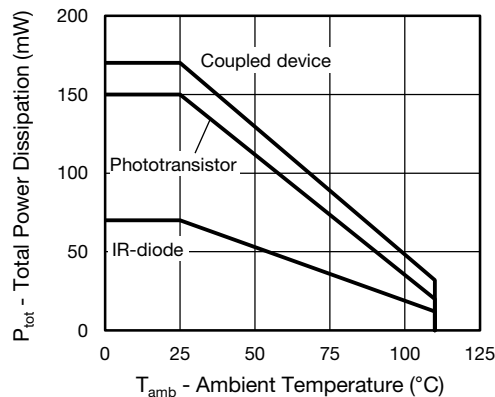

Fig. 1 - Total Power Dissipation vs. Ambient Temperature



ELECTRICAL CHARACTERISTICS ($T_{amb} = 25\text{ }^{\circ}\text{C}$, unless otherwise specified)						
PARAMETER	TEST CONDITION	SYMBOL	MIN.	TYP.	MAX.	UNIT
INPUT						
Forward voltage	$I_F = 5\text{ mA}$	V_F		1.1	1.6	V
Reverse current	$V_R = 6\text{ V}$	I_R		0.01	10	μA
Capacitance	$V_R = 0\text{ V}$, $f = 1\text{ MHz}$	C_j		9		pF
OUTPUT						
Collector emitter leakage current	$V_{CE} = 20\text{ V}$	I_{CEO}		0.3	100	nA
Collector emitter breakdown voltage	$I_C = 100\text{ }\mu\text{A}$	BV_{CEO}	80			V
Emitter collector breakdown voltage	$I_E = 10\text{ }\mu\text{A}$	BV_{ECO}	7			V
Collector emitter capacitance	$V_{CE} = 5\text{ V}$, $f = 1\text{ MHz}$	C_{CE}		2.8		pF
COUPLER						
Coupling capacitance	$f = 1\text{ MHz}$	C_{IO}		0.3		pF
Collector emitter saturation voltage	$I_F = 10\text{ mA}$, $I_C = 2.5\text{ mA}$	V_{CEsat}		0.12	0.4	V
Cut-off frequency	$I_F = 10\text{ mA}$, $V_{CC} = 5\text{ V}$, $R_L = 100\text{ }\Omega$	f_{ctr}		110		kHz

Note

- Minimum and maximum values are testing requirements. Typical values are characteristics of the device and are the result of engineering evaluation. Typical values are for information only and are not part of the testing requirements.

CURRENT TRANSFER RATIO ($T_{amb} = 25\text{ }^{\circ}\text{C}$, unless otherwise specified)							
PARAMETER	TEST CONDITION	PART	SYMBOL	MIN.	TYP.	MAX.	UNIT
I_C/I_F	$I_F = 5\text{ mA}$, $V_{CE} = 5\text{ V}$	VOM617A	CTR	50		600	%
		VOM617A-2	CTR	63		125	%
		VOM617A-3	CTR	100		200	%
		VOM617A-4	CTR	160		320	%
		VOM617A-6	CTR	250		500	%
		VOM617A-7	CTR	80		160	%
		VOM617A-8	CTR	130		260	%
		VOM617A-9	CTR	200		400	%

SWITCHING CHARACTERISTICS ($T_{amb} = 25\text{ }^{\circ}\text{C}$, unless otherwise specified)						
PARAMETER	TEST CONDITION	SYMBOL	MIN.	TYP.	MAX.	UNIT
NON-SATURATED						
Rise and fall time	$I_C = 2\text{ mA}$, $V_{CC} = 5\text{ V}$, $R_L = 100\text{ }\Omega$	t_r		3		μs
Fall time		t_f		3		μs
Turn-on time		t_{on}		6		μs
Turn-off time		t_{off}		4		μs
SATURATED						
Rise and fall time	$I_F = 1.6\text{ mA}$, $V_{CC} = 5\text{ V}$, $R_L = 1.9\text{ k}\Omega$	t_r		7		μs
Fall time		t_f		12		μs
Turn-on time		t_{on}		9		μs
Turn-off time		t_{off}		15		μs

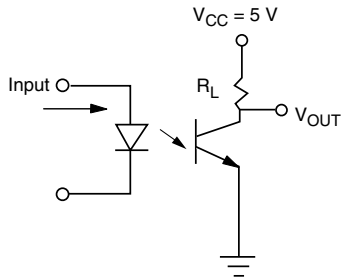

Fig. 2 - Test Circuit

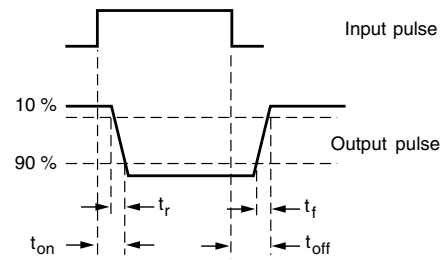

Fig. 3 - Test Circuit and Waveforms

SAFETY AND INSULATION RATINGS				
PARAMETER		SYMBOL	VALUE	UNIT
MAXIMUM SAFETY RATINGS				
Output safety power		P_{SO}	300	mW
Input safety current		I_{si}	200	mW
Safety temperature		T_S	150	°C
Comparative tracking index		CTI	175	
INSULATION RATED PARAMETERS				
Maximum withstanding isolation voltage		V_{ISO}	3750	V_{RMS}
Maximum transient isolation voltage		V_{IOTM}	6000	V_{peak}
Maximum repetitive peak isolation voltage		V_{IORM}	565	V_{peak}
Insulation resistance	$T_{amb} = 25\text{ °C}, V_{DC} = 500\text{ V}$	R_{IO}	10^{12}	Ω
Isolation resistance	$T_{amb} = 100\text{ °C}, V_{DC} = 500\text{ V}$	R_{IO}	10^{11}	Ω
Climatic classification (according to IEC 68 part 1)			55/110/21	
Environment (pollution degree in accordance to DIN VDE 0109)			2	
Internal creepage			≥ 5	mm
External creepage			≥ 5	mm
Clearance			≥ 5	mm
Insulation thickness			≥ 0.4	mm

Note

- As per DIN EN 60747-5-5 (VDE 0884), § 7.4.3.8.2, this optocoupler is suitable for “safe electrical insulation” only within the safety ratings. Compliance with the safety ratings shall be ensured by means of protective circuits.

TYPICAL CHARACTERISTICS ($T_{amb} = 25\text{ }^{\circ}\text{C}$, unless otherwise specified)

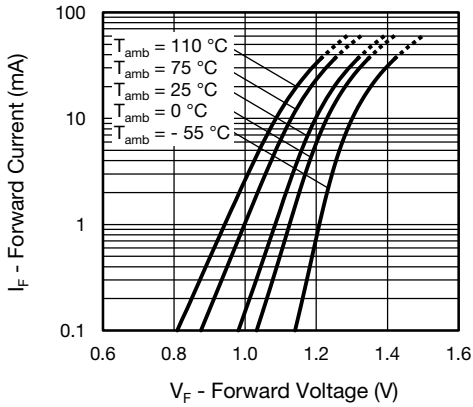

Fig. 4 - Forward Voltage vs. Forward Current

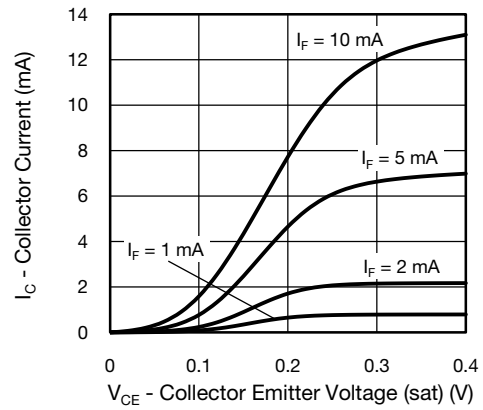

Fig. 7 - Collector Current vs. Collector Emitter Voltage (sat)

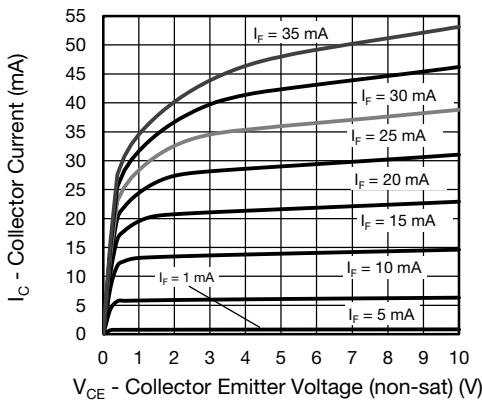

Fig. 5 - Collector Current vs. Collector Emitter Voltage (NS)

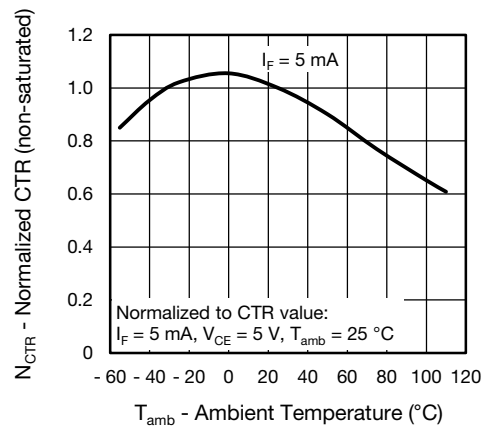

Fig. 8 - Normalized Current Transfer Ratio (non-sat) vs. Ambient Temperature

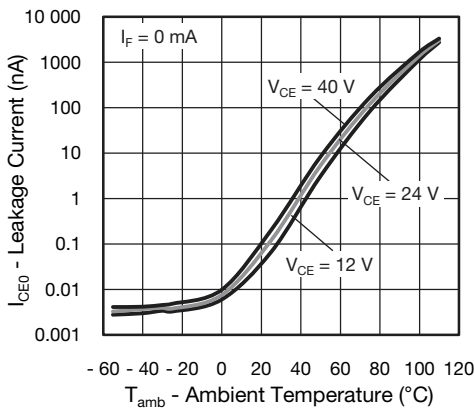

Fig. 6 - Leakage Current vs. Ambient Temperature

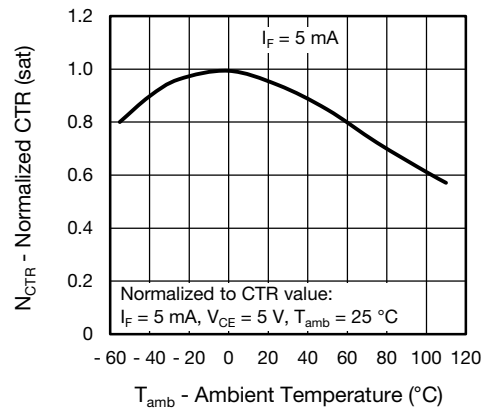

Fig. 9 - Normalized Current Transfer Ratio (sat) vs. Ambient Temperature

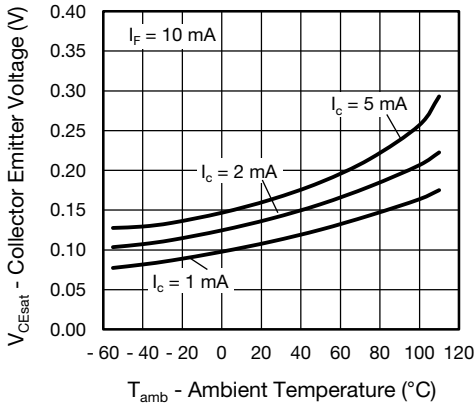

Fig. 10 - Collector Emitter Voltage vs. Ambient Temperature (saturated)

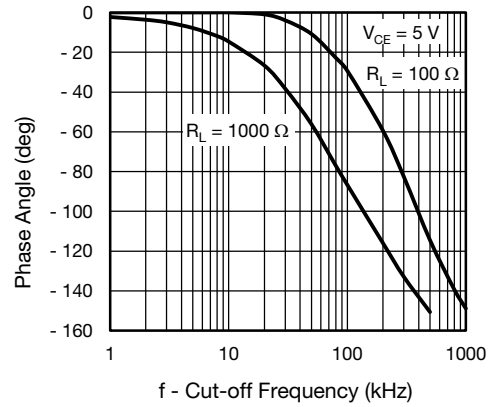

Fig. 13 - F_{CTR} vs. Phase Angle

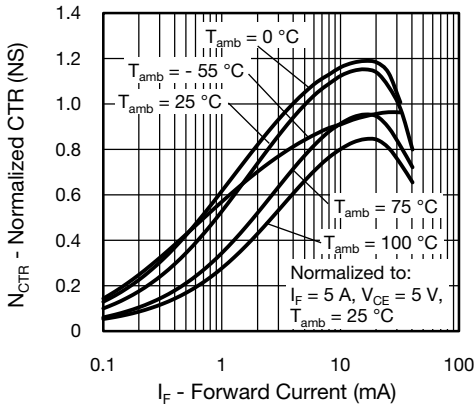

Fig. 11 - Normalized CTR (NS) vs. Forward Current

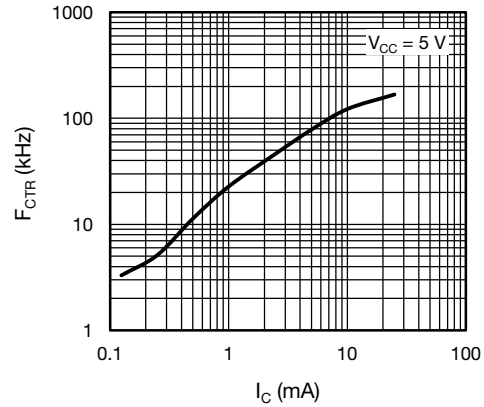

Fig. 14 - F_{CTR} vs. Collector Current

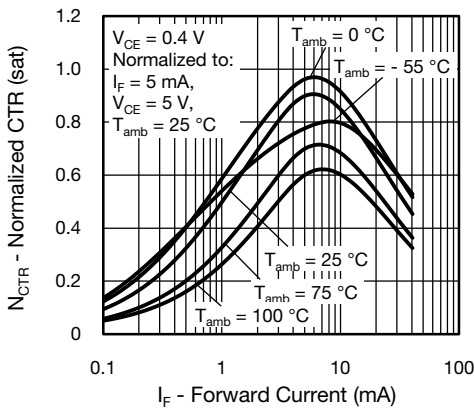

Fig. 12 - Normalized CTR (sat) vs. Forward Current

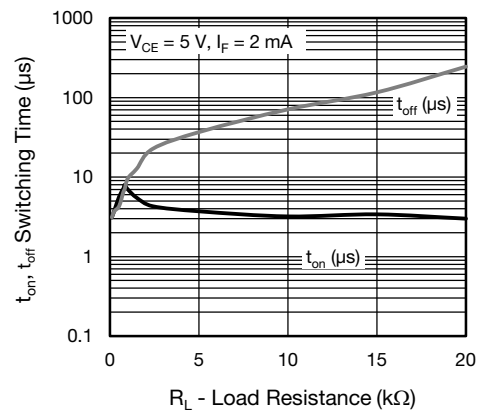
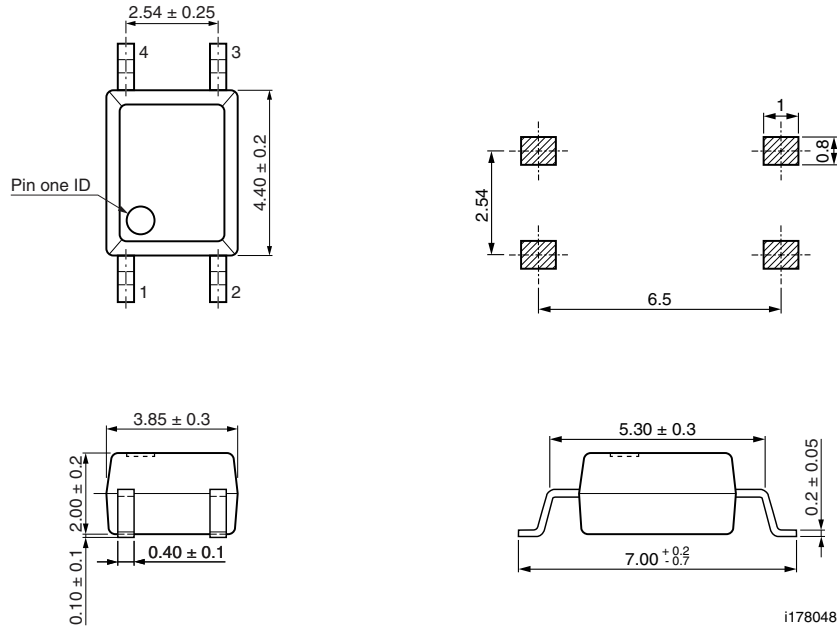
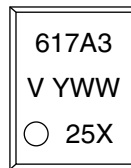

Fig. 15 - Switching Time vs. Load Resistance

PACKAGE DIMENSIONS in millimeters



PACKAGE MARKING (example of VOM617A-3X001T)



Notes

- Only option 1 is reflected in the package marking with the characters "X".
- Tape and reel suffix (T) is not part of the package marking.

TAPE AND REEL DIMENSIONS in millimeters

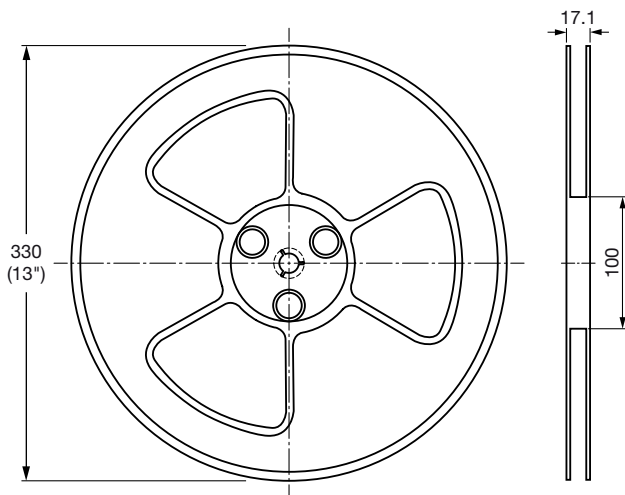

Fig. 16 - Reel Dimensions (3000 units per reel)

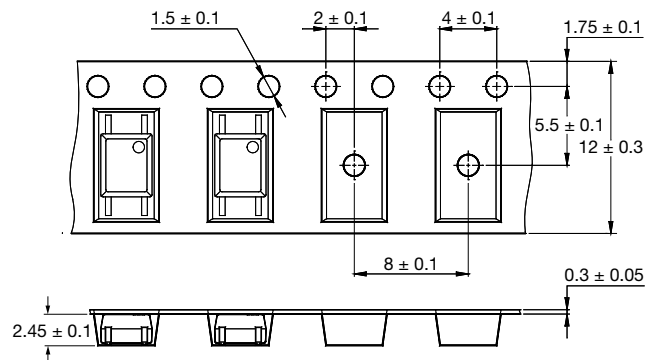

Fig. 17 - Tape Dimensions



Disclaimer

ALL PRODUCT, PRODUCT SPECIFICATIONS AND DATA ARE SUBJECT TO CHANGE WITHOUT NOTICE TO IMPROVE RELIABILITY, FUNCTION OR DESIGN OR OTHERWISE.

Vishay Intertechnology, Inc., its affiliates, agents, and employees, and all persons acting on its or their behalf (collectively, "Vishay"), disclaim any and all liability for any errors, inaccuracies or incompleteness contained in any datasheet or in any other disclosure relating to any product.

Vishay makes no warranty, representation or guarantee regarding the suitability of the products for any particular purpose or the continuing production of any product. To the maximum extent permitted by applicable law, Vishay disclaims (i) any and all liability arising out of the application or use of any product, (ii) any and all liability, including without limitation special, consequential or incidental damages, and (iii) any and all implied warranties, including warranties of fitness for particular purpose, non-infringement and merchantability.

Statements regarding the suitability of products for certain types of applications are based on Vishay's knowledge of typical requirements that are often placed on Vishay products in generic applications. Such statements are not binding statements about the suitability of products for a particular application. It is the customer's responsibility to validate that a particular product with the properties described in the product specification is suitable for use in a particular application. Parameters provided in datasheets and/or specifications may vary in different applications and performance may vary over time. All operating parameters, including typical parameters, must be validated for each customer application by the customer's technical experts. Product specifications do not expand or otherwise modify Vishay's terms and conditions of purchase, including but not limited to the warranty expressed therein.

Except as expressly indicated in writing, Vishay products are not designed for use in medical, life-saving, or life-sustaining applications or for any other application in which the failure of the Vishay product could result in personal injury or death. Customers using or selling Vishay products not expressly indicated for use in such applications do so at their own risk. Please contact authorized Vishay personnel to obtain written terms and conditions regarding products designed for such applications.

No license, express or implied, by estoppel or otherwise, to any intellectual property rights is granted by this document or by any conduct of Vishay. Product names and markings noted herein may be trademarks of their respective owners.

Material Category Policy

Vishay Intertechnology, Inc. hereby certifies that all its products that are identified as RoHS-Compliant fulfill the definitions and restrictions defined under Directive 2011/65/EU of The European Parliament and of the Council of June 8, 2011 on the restriction of the use of certain hazardous substances in electrical and electronic equipment (EEE) - recast, unless otherwise specified as non-compliant.

Please note that some Vishay documentation may still make reference to RoHS Directive 2002/95/EC. We confirm that all the products identified as being compliant to Directive 2002/95/EC conform to Directive 2011/65/EU.

Vishay Intertechnology, Inc. hereby certifies that all its products that are identified as Halogen-Free follow Halogen-Free requirements as per JEDEC JS709A standards. Please note that some Vishay documentation may still make reference to the IEC 61249-2-21 definition. We confirm that all the products identified as being compliant to IEC 61249-2-21 conform to JEDEC JS709A standards.

Данный компонент на территории Российской Федерации

Вы можете приобрести в компании MosChip.

Для оперативного оформления запроса Вам необходимо перейти по данной ссылке:

<http://moschip.ru/get-element>

Вы можете разместить у нас заказ для любого Вашего проекта, будь то серийное производство или разработка единичного прибора.

В нашем ассортименте представлены ведущие мировые производители активных и пассивных электронных компонентов.

Нашей специализацией является поставка электронной компонентной базы двойного назначения, продукции таких производителей как XILINX, Intel (ex.ALTERA), Vicor, Microchip, Texas Instruments, Analog Devices, Mini-Circuits, Amphenol, Glenair.

Сотрудничество с глобальными дистрибьюторами электронных компонентов, предоставляет возможность заказывать и получать с международных складов практически любой перечень компонентов в оптимальные для Вас сроки.

На всех этапах разработки и производства наши партнеры могут получить квалифицированную поддержку опытных инженеров.

Система менеджмента качества компании отвечает требованиям в соответствии с ГОСТ Р ИСО 9001, ГОСТ РВ 0015-002 и ЭС РД 009

Офис по работе с юридическими лицами:

105318, г.Москва, ул.Щербаковская д.3, офис 1107, 1118, ДЦ «Щербаковский»

Телефон: +7 495 668-12-70 (многоканальный)

Факс: +7 495 668-12-70 (доб.304)

E-mail: info@moschip.ru

Skype отдела продаж:

moschip.ru

moschip.ru_4

moschip.ru_6

moschip.ru_9