

Infrared Emitting Diode, 875 nm, GaAlAs

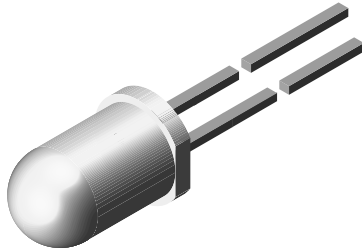

94 8389

FEATURES

- Package type: leaded
- Package form: T-1 $\frac{3}{4}$
- Dimensions (in mm): \varnothing 5
- Peak wavelength: $\lambda_p = 875$ nm
- High reliability
- Angle of half intensity: $\varphi = \pm 12^\circ$
- Low forward voltage
- Suitable for high pulse current operation
- Good spectral matching with Si photodetectors
- Compliant to RoHS directive 2002/95/EC and in accordance to WEEE 2002/96/EC
- Halogen-free according to IEC 61249-2-21 definition



RoHS
COMPLIANT
HALOGEN
FREE

DESCRIPTION

The TSHA620. series are infrared, 875 nm emitting diodes in GaAlAs technology, molded in a clear, untinted plastic package.

APPLICATIONS

- Infrared remote control and free air data transmission systems
- This emitter series is dedicated to systems with panes in transmission space between emitter and detector, because of the low absorption of 875 nm radiation in glass

| PRODUCT SUMMARY | | | | |
|-----------------|---------------|-----------------|------------------|------------|
| COMPONENT | I_e (mW/sr) | φ (deg) | λ_p (nm) | t_r (ns) |
| TSHA6200 | 40 | ± 12 | 875 | 600 |
| TSHA6201 | 50 | ± 12 | 875 | 600 |
| TSHA6202 | 60 | ± 12 | 875 | 600 |
| TSHA6203 | 65 | ± 12 | 875 | 600 |

Note

Test conditions see table "Basic Characteristics"

| ORDERING INFORMATION | | | |
|----------------------|-----------|------------------------------|-------------------|
| ORDERING CODE | PACKAGING | REMARKS | PACKAGE FORM |
| TSHA6200 | Bulk | MOQ: 4000 pcs, 4000 pcs/bulk | T-1 $\frac{3}{4}$ |
| TSHA6201 | Bulk | MOQ: 4000 pcs, 4000 pcs/bulk | T-1 $\frac{3}{4}$ |
| TSHA6202 | Bulk | MOQ: 4000 pcs, 4000 pcs/bulk | T-1 $\frac{3}{4}$ |
| TSHA6203 | Bulk | MOQ: 4000 pcs, 4000 pcs/bulk | T-1 $\frac{3}{4}$ |

Note

MOQ: minimum order quantity

| ABSOLUTE MAXIMUM RATINGS | | | | |
|-------------------------------------|--|------------|---------------|------------|
| PARAMETER | TEST CONDITION | SYMBOL | VALUE | UNIT |
| Reverse voltage | | V_R | 5 | V |
| Forward current | | I_F | 100 | mA |
| Peak forward current | $t_p/T = 0.5, t_p = 100 \mu s$ | I_{FM} | 200 | mA |
| Surge forward current | $t_p = 100 \mu s$ | I_{FSM} | 2.5 | A |
| Power dissipation | | P_V | 180 | mW |
| Junction temperature | | T_j | 100 | $^\circ C$ |
| Operating temperature range | | T_{amb} | - 40 to + 85 | $^\circ C$ |
| Storage temperature range | | T_{stg} | - 40 to + 100 | $^\circ C$ |
| Soldering temperature | $t \leq 5$ s, 2 mm from case | T_{sd} | 260 | $^\circ C$ |
| Thermal resistance junction/ambient | J-STD-051, leads 7 mm, soldered on PCB | R_{thJA} | 230 | K/W |

Note

$T_{amb} = 25 \text{ }^\circ C$, unless otherwise specified

TSHA6200, TSHA6201, TSHA6202, TSHA6203



Vishay Semiconductors Infrared Emitting Diode, 875 nm, GaAlAs

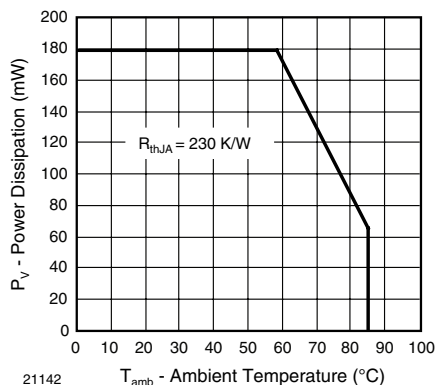

Fig. 1 - Power Dissipation Limit vs. Ambient Temperature

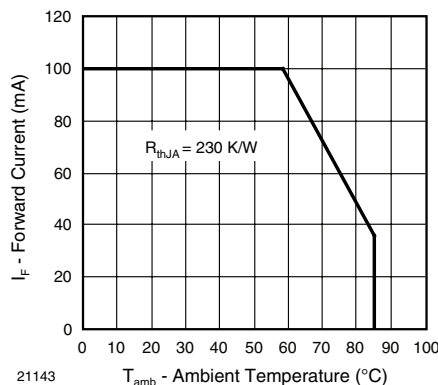

Fig. 2 - Forward Current Limit vs. Ambient Temperature

| BASIC CHARACTERISTICS | | | | | | |
|---|---|-----------------------------|------|-------|------|------|
| PARAMETER | TEST CONDITION | SYMBOL | MIN. | TYP. | MAX. | UNIT |
| Forward voltage | I _F = 100 mA, t _p = 20 ms | V _F | | 1.5 | 1.8 | V |
| Temperature coefficient of V _F | I _F = 100 mA | TK _{V_F} | | - 1.6 | | mV/K |
| Reverse current | V _R = 5 V | I _R | | | 100 | μA |
| Junction capacitance | V _R = 0 V, f = 1 MHz, E = 0 | C _j | | 20 | | pF |
| Temperature coefficient of φ _e | I _F = 20 mA | TKφ _e | | - 0.7 | | %/K |
| Angle of half intensity | | φ | | ± 12 | | deg |
| Peak wavelength | I _F = 100 mA | λ _p | | 875 | | nm |
| Spectral bandwidth | I _F = 100 mA | Δλ | | 80 | | nm |
| Temperature coefficient of λ _p | I _F = 100 mA | TKλ _p | | 0.2 | | nm/K |
| Rise time | I _F = 100 mA | t _r | | 600 | | ns |
| | I _F = 1 A | t _r | | 300 | | ns |
| Fall time | I _F = 100 mA | t _f | | 600 | | ns |
| | I _F = 1 A | t _f | | 300 | | ns |
| Virtual source diameter | | d | | 3.7 | | mm |

Note

T_{amb} = 25 °C, unless otherwise specified



TSHA6200, TSHA6201, TSHA6202, TSHA6203

Infrared Emitting Diode, 875 nm, GaAlAs Vishay Semiconductors

| TYPE DEDICATED CHARACTERISTICS | | | | | | | |
|--------------------------------|--|----------|----------|------|------|------|-------|
| PARAMETER | TEST CONDITION | PART | SYMBOL | MIN. | TYP. | MAX. | UNIT |
| Forward voltage | $I_F = 1 \text{ A}$, $t_p = 100 \mu\text{s}$ | TSHA6200 | V_F | | 2.8 | 3.5 | V |
| | | TSHA6201 | V_F | | 2.8 | 3.5 | V |
| | | TSHA6202 | V_F | | 2.8 | 3.5 | V |
| | | TSHA6203 | V_F | | 2.8 | 3.5 | V |
| Radiant intensity | $I_F = 100 \text{ mA}$, $t_p = 20 \text{ ms}$ | TSHA6200 | I_e | 25 | 40 | 125 | mW/sr |
| | | TSHA6201 | I_e | 30 | 50 | 125 | mW/sr |
| | | TSHA6202 | I_e | 36 | 60 | 125 | mW/sr |
| | | TSHA6203 | I_e | 50 | 65 | 125 | mW/sr |
| | $I_F = 1 \text{ A}$, $t_p = 100 \mu\text{s}$ | TSHA6200 | I_e | 200 | 330 | | mW/sr |
| | | TSHA6201 | I_e | 260 | 400 | | mW/sr |
| | | TSHA6202 | I_e | 330 | 460 | | mW/sr |
| | | TSHA6203 | I_e | 400 | 530 | | mW/sr |
| Radiant power | $I_F = 100 \text{ mA}$, $t_p = 20 \text{ ms}$ | TSHA6200 | ϕ_e | | 22 | | mW |
| | | TSHA6201 | ϕ_e | | 23 | | mW |
| | | TSHA6202 | ϕ_e | | 24 | | mW |
| | | TSHA6203 | ϕ_e | | 25 | | mW |

Note

$T_{amb} = 25 \text{ }^\circ\text{C}$, unless otherwise specified

BASIC CHARACTERISTICS

$T_{amb} = 25 \text{ }^\circ\text{C}$, unless otherwise specified

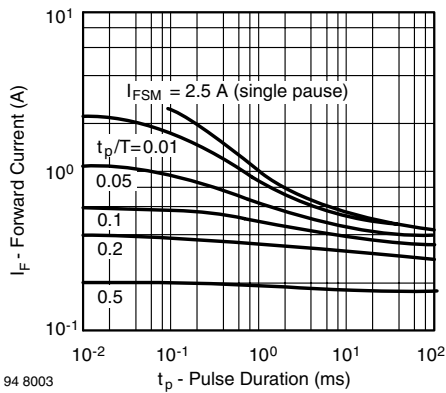

Fig. 3 - Pulse Forward Current vs. Pulse Duration

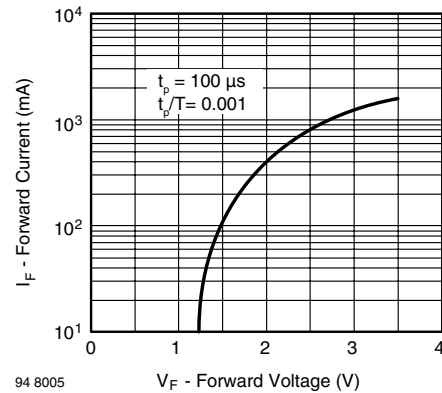

Fig. 4 - Forward Current vs. Forward Voltage

TSHA6200, TSHA6201, TSHA6202, TSHA6203



Vishay Semiconductors Infrared Emitting Diode, 875 nm, GaAlAs

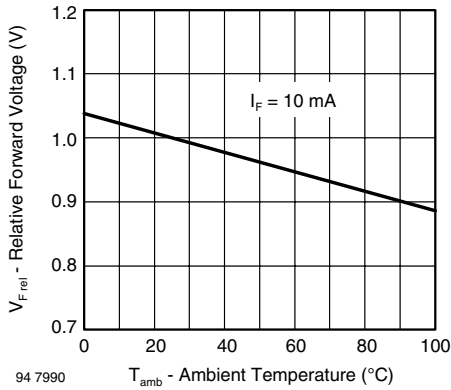

Fig. 5 - Relative Forward Voltage vs. Ambient Temperature

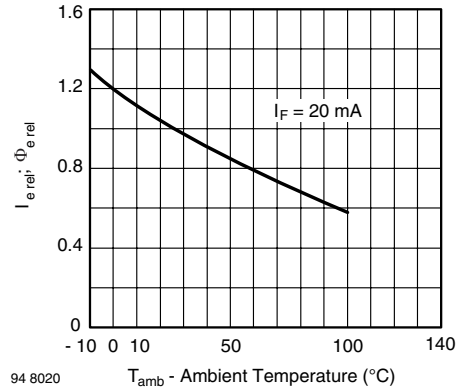

Fig. 8 - Relative Radiant Intensity/Power vs. Ambient Temperature

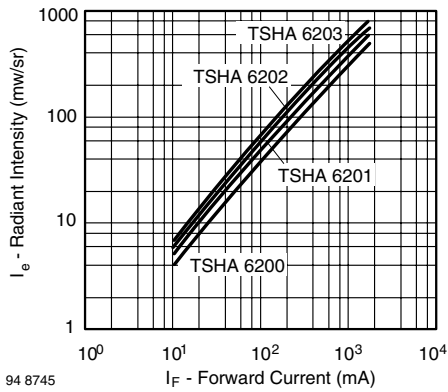

Fig. 6 - Radiant Intensity vs. Forward Current

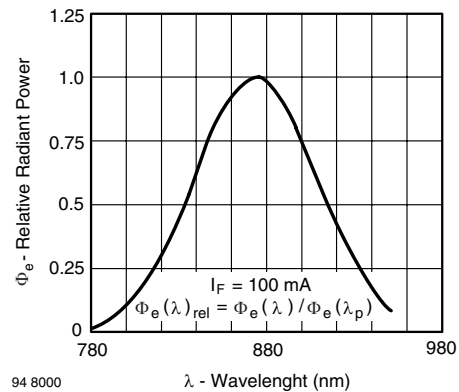

Fig. 9 - Relative Radiant Power vs. Wavelength

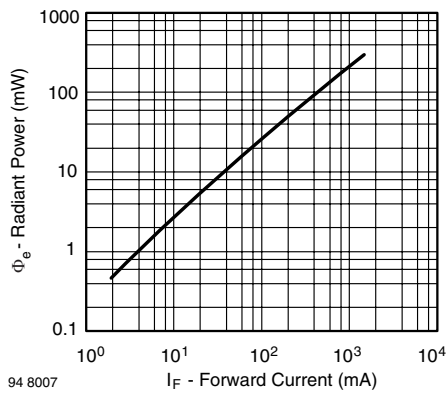

Fig. 7 - Radiant Power vs. Forward Current

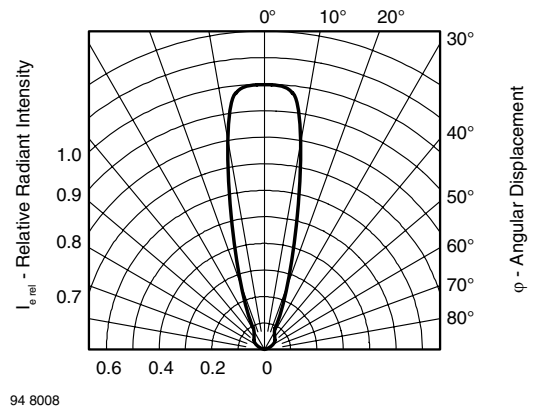

Fig. 10 - Relative Radiant Intensity vs. Angular Displacement



TSHA6200, TSHA6201, TSHA6202, TSHA6203

Infrared Emitting Diode, 875 nm, GaAlAs Vishay Semiconductors

PACKAGE DIMENSIONS in millimeters

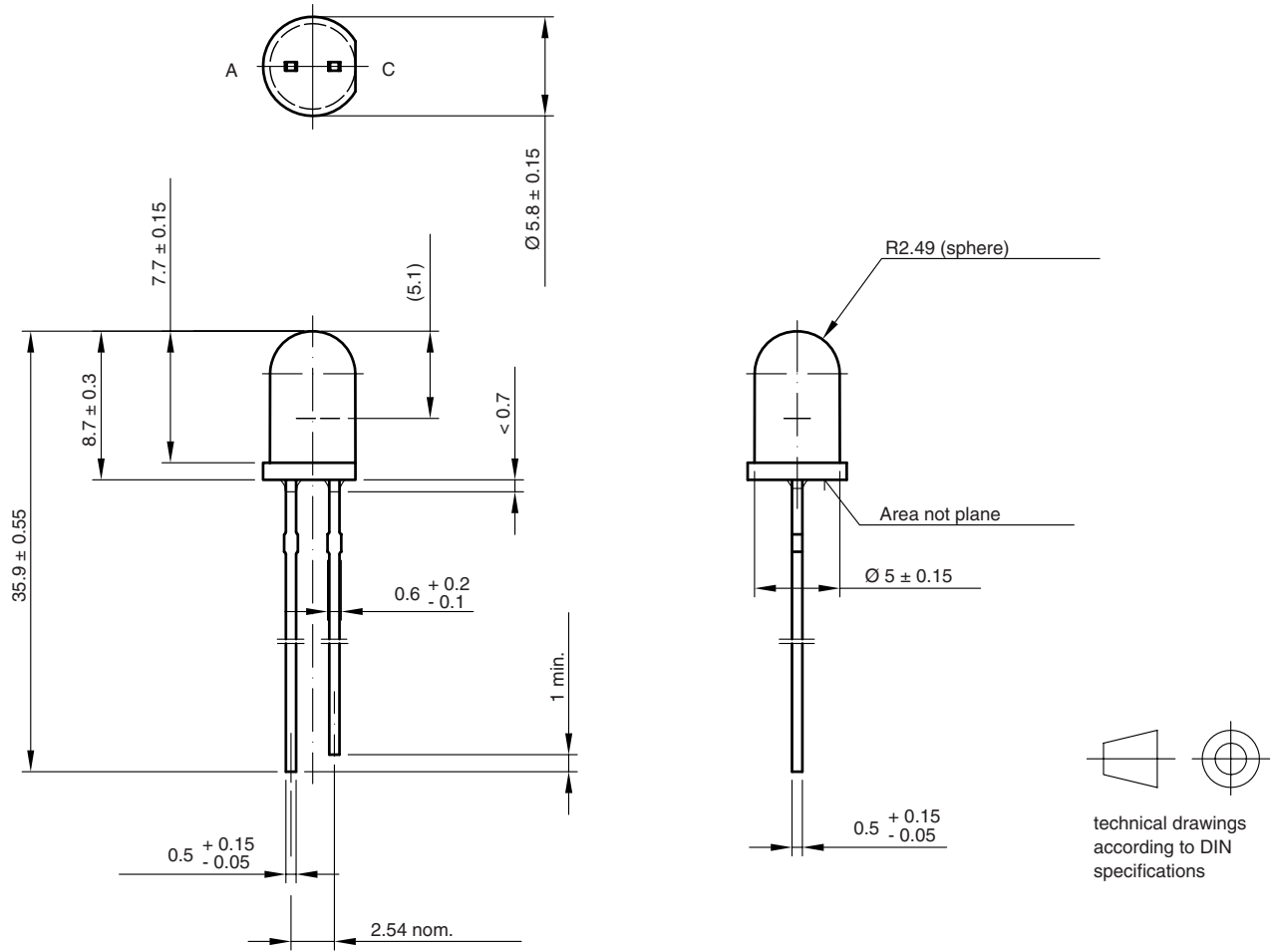

Drawing-No.: 6.544-5259.04-4
Issue: 8; 19.05.09
96 12125



Disclaimer

ALL PRODUCT, PRODUCT SPECIFICATIONS AND DATA ARE SUBJECT TO CHANGE WITHOUT NOTICE TO IMPROVE RELIABILITY, FUNCTION OR DESIGN OR OTHERWISE.

Vishay Intertechnology, Inc., its affiliates, agents, and employees, and all persons acting on its or their behalf (collectively, "Vishay"), disclaim any and all liability for any errors, inaccuracies or incompleteness contained in any datasheet or in any other disclosure relating to any product.

Vishay makes no warranty, representation or guarantee regarding the suitability of the products for any particular purpose or the continuing production of any product. To the maximum extent permitted by applicable law, Vishay disclaims (i) any and all liability arising out of the application or use of any product, (ii) any and all liability, including without limitation special, consequential or incidental damages, and (iii) any and all implied warranties, including warranties of fitness for particular purpose, non-infringement and merchantability.

Statements regarding the suitability of products for certain types of applications are based on Vishay's knowledge of typical requirements that are often placed on Vishay products in generic applications. Such statements are not binding statements about the suitability of products for a particular application. It is the customer's responsibility to validate that a particular product with the properties described in the product specification is suitable for use in a particular application. Parameters provided in datasheets and/or specifications may vary in different applications and performance may vary over time. All operating parameters, including typical parameters, must be validated for each customer application by the customer's technical experts. Product specifications do not expand or otherwise modify Vishay's terms and conditions of purchase, including but not limited to the warranty expressed therein.

Except as expressly indicated in writing, Vishay products are not designed for use in medical, life-saving, or life-sustaining applications or for any other application in which the failure of the Vishay product could result in personal injury or death. Customers using or selling Vishay products not expressly indicated for use in such applications do so at their own risk and agree to fully indemnify and hold Vishay and its distributors harmless from and against any and all claims, liabilities, expenses and damages arising or resulting in connection with such use or sale, including attorneys fees, even if such claim alleges that Vishay or its distributor was negligent regarding the design or manufacture of the part. Please contact authorized Vishay personnel to obtain written terms and conditions regarding products designed for such applications.

No license, express or implied, by estoppel or otherwise, to any intellectual property rights is granted by this document or by any conduct of Vishay. Product names and markings noted herein may be trademarks of their respective owners.

Данный компонент на территории Российской Федерации

Вы можете приобрести в компании MosChip.

Для оперативного оформления запроса Вам необходимо перейти по данной ссылке:

<http://moschip.ru/get-element>

Вы можете разместить у нас заказ для любого Вашего проекта, будь то серийное производство или разработка единичного прибора.

В нашем ассортименте представлены ведущие мировые производители активных и пассивных электронных компонентов.

Нашей специализацией является поставка электронной компонентной базы двойного назначения, продукции таких производителей как XILINX, Intel (ex.ALTERA), Vicor, Microchip, Texas Instruments, Analog Devices, Mini-Circuits, Amphenol, Glenair.

Сотрудничество с глобальными дистрибьюторами электронных компонентов, предоставляет возможность заказывать и получать с международных складов практически любой перечень компонентов в оптимальные для Вас сроки.

На всех этапах разработки и производства наши партнеры могут получить квалифицированную поддержку опытных инженеров.

Система менеджмента качества компании отвечает требованиям в соответствии с ГОСТ Р ИСО 9001, ГОСТ РВ 0015-002 и ЭС РД 009

Офис по работе с юридическими лицами:

105318, г.Москва, ул.Щербаковская д.3, офис 1107, 1118, ДЦ «Щербаковский»

Телефон: +7 495 668-12-70 (многоканальный)

Факс: +7 495 668-12-70 (доб.304)

E-mail: info@moschip.ru

Skype отдела продаж:

moschip.ru

moschip.ru_4

moschip.ru_6

moschip.ru_9