

STRADELLA-CY

Beam for canopy lighting with batwing light distribution. Suitable for symmetrical tunnel lighting.

TECHNICAL SPECIFICATIONS:

Dimensions	13.9 mm
Height	4.7 mm
Fastening	pin
ROHS compliant	yes ⓘ

MATERIAL SPECIFICATIONS:

Component	Type	Material	Colour	Finish
STRADELLA-CY	Single lens	PMMA	clear	

ORDERING INFORMATION:

Component	Qty in box	MOQ	MPQ	Box weight (kg)
C15437_STRADELLA-CY » Box size: 480 x 250 x 390 mm	16000	1000	1000	7.3



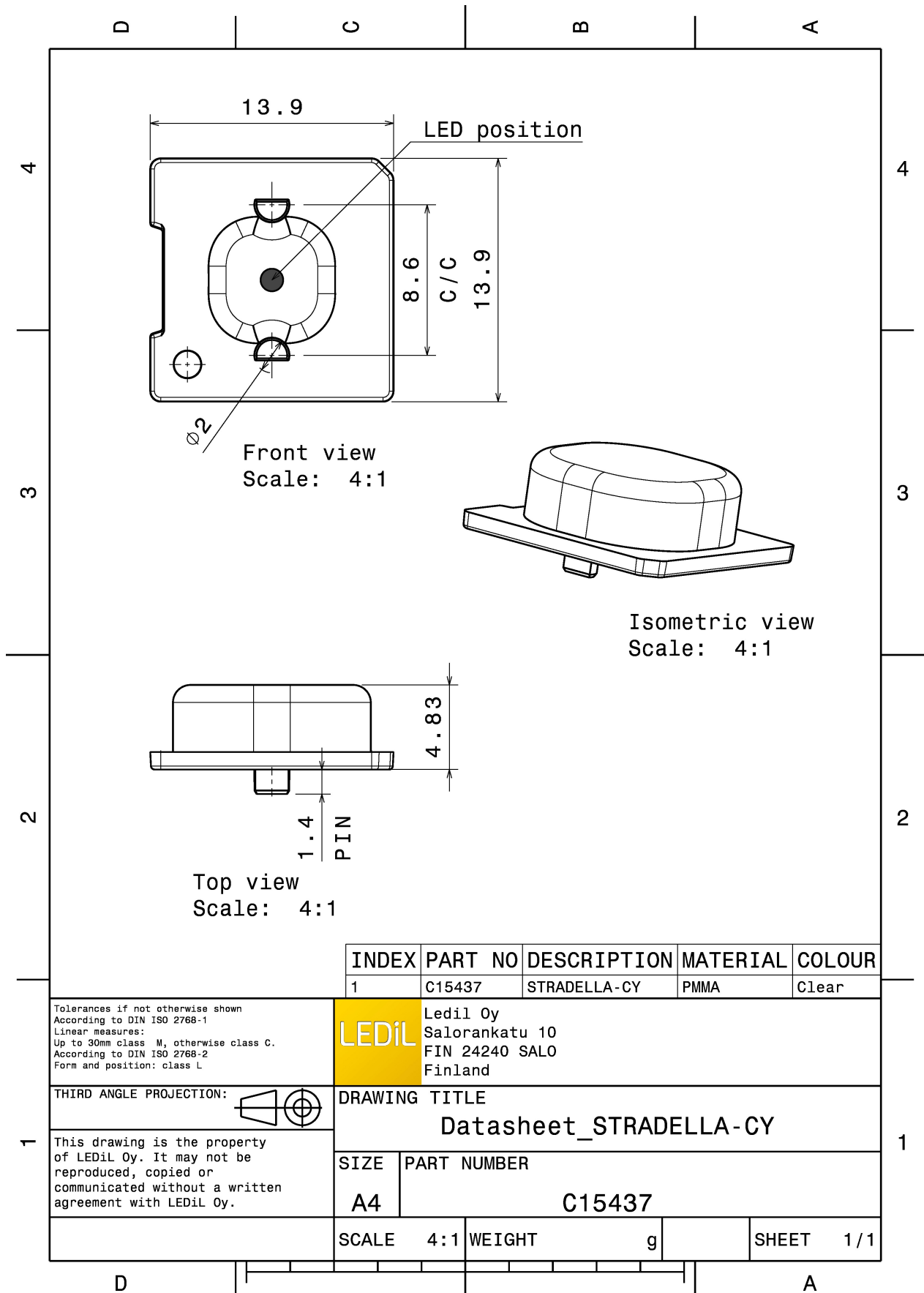

INDEX	PART NO	DESCRIPTION	MATERIAL	COLOUR
1	C15437	STRADELLA-CY	PMMA	Clear

Tolerances if not otherwise shown
According to DIN ISO 2768-1
Linear measures:
Up to 30mm class M, otherwise class C.
According to DIN ISO 2768-2
Form and position: class L



Ledil Oy
Salorankatu 10
FIN 24240 SALO
Finland

THIRD ANGLE PROJECTION:

DRAWING TITLE
Datasheet_STRADELLA-CY

This drawing is the property of LEDiL Oy. It may not be reproduced, copied or communicated without a written agreement with LEDiL Oy.

SIZE	PART NUMBER
A4	C15437

SCALE	4:1	WEIGHT	g	SHEET	1/1
-------	-----	--------	---	-------	-----

PHOTOMETRIC DATA (MEASURED):

CREE

LED XT-E
 FWHM 115.0°
 Efficiency 94 %
 Peak intensity 0.3 cd/lm
 LEDs/each optic 1
 Light colour White
 Required components:

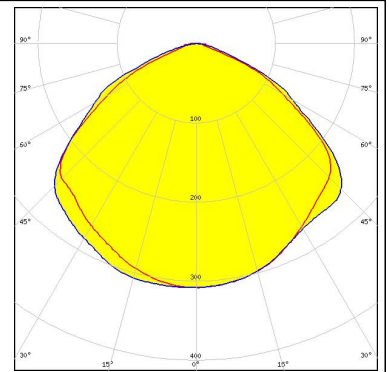

NICHIA

LED NVSW219D
 FWHM 114.0°
 Efficiency 94 %
 Peak intensity 0.4 cd/lm
 LEDs/each optic 1
 Light colour White
 Required components:

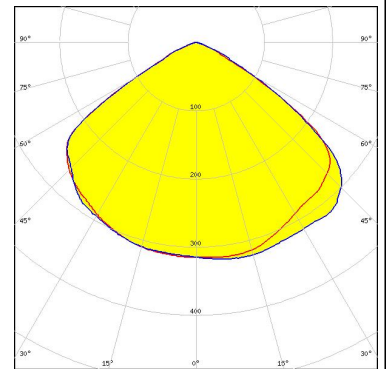
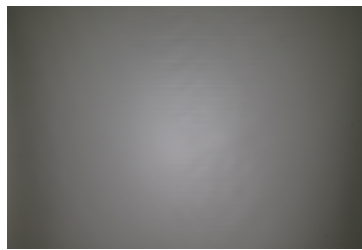

NICHIA

LED NVSW319B
 FWHM Asymmetric
 Efficiency 94 %
 Peak intensity 0.4 cd/lm
 LEDs/each optic 1
 Light colour White
 Required components:

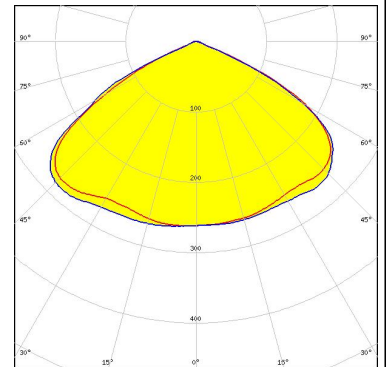

SAMSUNG

LED LH181B
 FWHM 116.0°
 Efficiency 94 %
 Peak intensity 0.4 cd/lm
 LEDs/each optic 1
 Light colour White
 Required components:

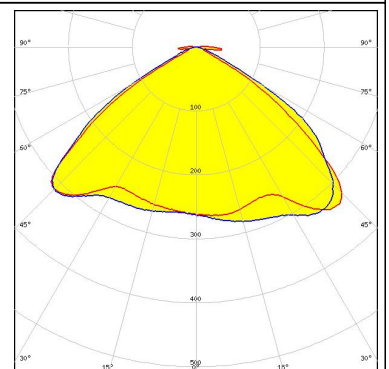

PHOTOMETRIC DATA (SIMULATED):



LED XP-E2
FWHM 117.0°
Efficiency 90 %
Peak intensity 0.4 cd/lm
LEDs/each optic 1
Light colour White
Required components:

Transparent protective cover

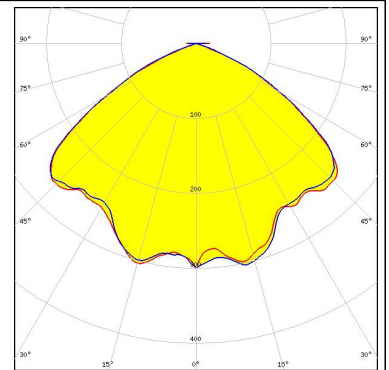

LED XP-G2 HE
FWHM 121.0°
Efficiency 95 %
Peak intensity 0.3 cd/lm
LEDs/each optic 1
Light colour White
Required components:

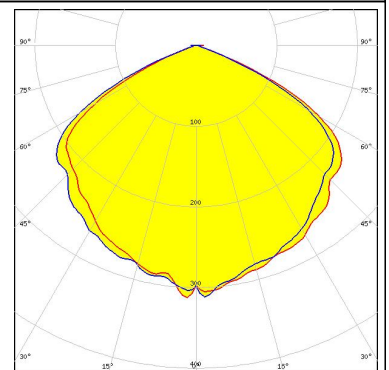

LED LUXEON IR Domed 150
FWHM 133.0°
Efficiency 94 %
LEDs/each optic 1
Light colour White
Required components:



LED OSCONIQ P 3030
FWHM 112.0°
Efficiency 96 %
Peak intensity 0.4 cd/lm
LEDs/each optic 1
Light colour White
Required components:

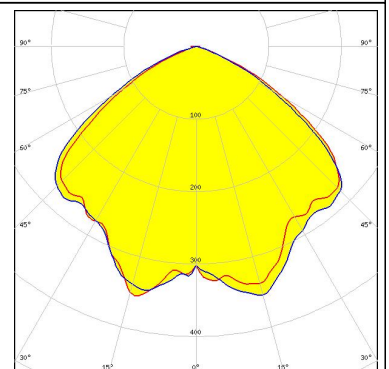

PHOTOMETRIC DATA (SIMULATED):

OSRAM

Opto Semiconductors

LED OSCONIQ P 3737 (2W version)
 FWHM 115.0°
 Efficiency 94 %
 Peak intensity 0.4 cd/lm
 LEDs/each optic 1
 Light colour White
 Required components:

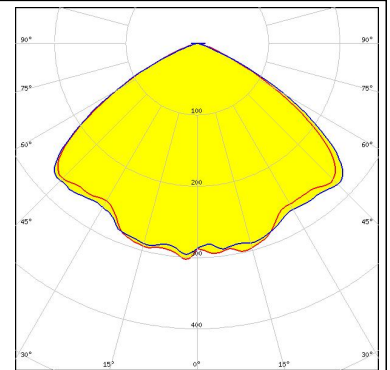

OSRAM

Opto Semiconductors

LED OSCONIQ P 3737 (3W version)
 FWHM 117.0°
 Efficiency 96 %
 Peak intensity 0.3 cd/lm
 LEDs/each optic 1
 Light colour White
 Required components:

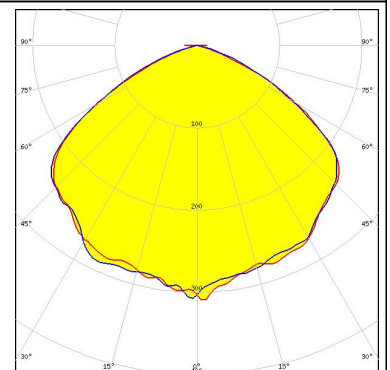

OSRAM

Opto Semiconductors

LED OSLON Square CSSRM2/CSSRM3
 FWHM 120.0°
 Efficiency 96 %
 Peak intensity 0.3 cd/lm
 LEDs/each optic 1
 Light colour White
 Required components:

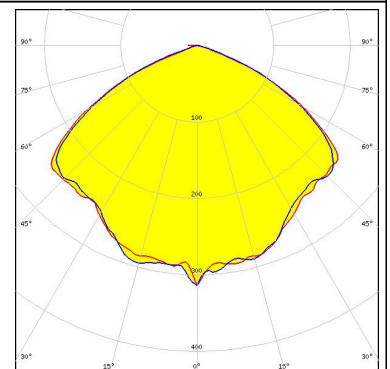

SAMSUNG

LED LH351B
 FWHM 110.0°
 Efficiency 92 %
 Peak intensity 0.3 cd/lm
 LEDs/each optic 1
 Light colour White
 Required components:

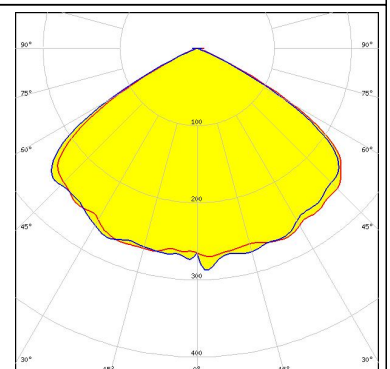

PHOTOMETRIC DATA (SIMULATED):

SAMSUNG

LED LH351D
 FWHM 123.0°
 Efficiency 94 %
 Peak intensity 0.3 cd/lm
 LEDs/each optic 1
 Light colour White
 Required components:

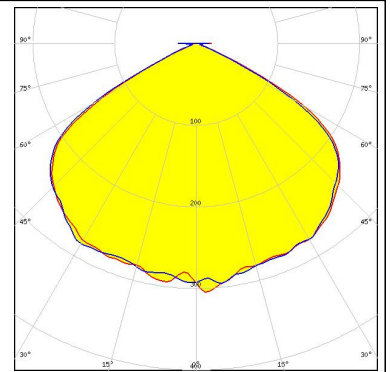

SEOUL SEMICONDUCTOR

LED SEOUL DC 5050 6V
 FWHM 114.0°
 Efficiency 94 %
 Peak intensity 0.3 cd/lm
 LEDs/each optic 1
 Light colour White
 Required components:

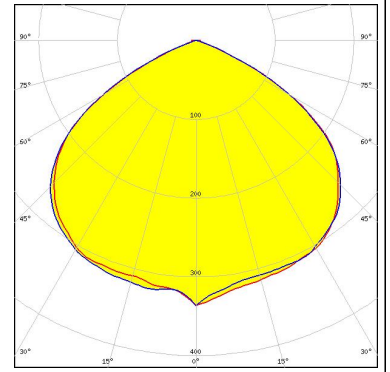

SEOUL SEMICONDUCTOR

LED Z5M1/Z5M2
 FWHM 118.0°
 Efficiency 96 %
 Peak intensity 0.4 cd/lm
 LEDs/each optic 1
 Light colour White
 Required components:

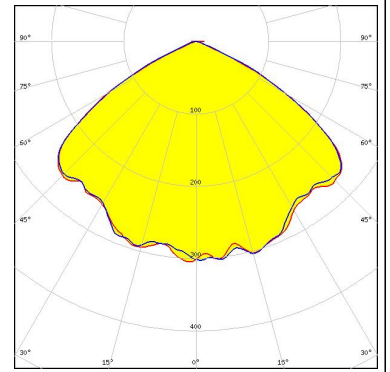

GENERAL INFORMATION:

NOTE: The typical beam angle will be changed by different color, chip size and chip position tolerance. The typical total beam angle is the full angle measured where the luminous intensity is half of the peak value.

MATERIALS:

As part of our continuous research and improvement processes, and to ensure the best possible quality and availability of our products, LEDiL reserves the right to change material grades without notice.

PRODUCT DATA USER AGREEMENT AND DISCLAIMER:

The measured data in the provided downloadable LEDiL Product Datasheets and Mechanical 2D-Drawings is rounded and provided as reference for planning. LEDiL Oy's optical specifications have been verified by conducting performance testing of the products in accordance with the company's quality system. The reported data are averaged results of multiple measurements with typical variation. LEDiL Oy reserves the right to without prior notification make changes and improvements to its products.

LEDiL Oy assumes neither warranty, nor guarantee nor any other liability of any kind for the contents and correctness of the provided data. The provided data has been generated with highest diligence but the provided data may in reality not represent the complete possible variation range of all intrinsic parameters. Therefore, in certain cases a deviation from the provided data could occur.

LEDiL Oy reserves the right to undertake technical changes of its products without further notification which could lead to changes in the provided data. LEDiL Oy assumes no liability of any kind for the possible deviation from any provided data or any other damage resulting from the usage of the provided data.

The user agrees to this disclaimer and user agreement with the download or usage of the provided files.

LEDiL Oy

Joensuunkatu 13
FI-24240 SALO
Finland

LEDiL Inc.

228 West Page Street
Suite D
Sycamore IL 60178
USA

Local sales and technical support

[www.ledil.com/
where_to_buy](http://www.ledil.com/where_to_buy)

Shipping locations

Salo, Finland
Hong Kong, China

Distribution Partners

[www.ledil.com/
where_to_buy](http://www.ledil.com/where_to_buy)

Данный компонент на территории Российской Федерации

Вы можете приобрести в компании MosChip.

Для оперативного оформления запроса Вам необходимо перейти по данной ссылке:

<http://moschip.ru/get-element>

Вы можете разместить у нас заказ для любого Вашего проекта, будь то серийное производство или разработка единичного прибора.

В нашем ассортименте представлены ведущие мировые производители активных и пассивных электронных компонентов.

Нашей специализацией является поставка электронной компонентной базы двойного назначения, продукции таких производителей как XILINX, Intel (ex.ALTERA), Vicor, Microchip, Texas Instruments, Analog Devices, Mini-Circuits, Amphenol, Glenair.

Сотрудничество с глобальными дистрибьюторами электронных компонентов, предоставляет возможность заказывать и получать с международных складов практически любой перечень компонентов в оптимальные для Вас сроки.

На всех этапах разработки и производства наши партнеры могут получить квалифицированную поддержку опытных инженеров.

Система менеджмента качества компании отвечает требованиям в соответствии с ГОСТ Р ИСО 9001, ГОСТ РВ 0015-002 и ЭС РД 009

Офис по работе с юридическими лицами:

105318, г.Москва, ул.Щербаковская д.3, офис 1107, 1118, ДЦ «Щербаковский»

Телефон: +7 495 668-12-70 (многоканальный)

Факс: +7 495 668-12-70 (доб.304)

E-mail: info@moschip.ru

Skype отдела продаж:

moschip.ru

moschip.ru_4

moschip.ru_6

moschip.ru_9