

**TWO PHASE HALL EFFECT LATCH WITH FG OUTPUT****AH211****General Description**

The AH211 is an integrated Hall sensor with output driver and frequency generator designed for electronic commutation of brush-less DC motor applications. The device includes an on-chip Hall sensor for magnetic sensing, an amplifier that amplifies the Hall voltage, a Schmitt trigger to provide switching hysteresis for noise rejection, a temperature compensation circuit to compensate the temperature drift of Hall sensitivity, two complementary open-collector drivers for sinking large load current. It also includes an internal band-gap regulator which is used to provide bias voltage for internal circuits.

Place the device in a variable magnetic field, while the magnetic flux density is larger than threshold BOP, DO will be turned on (low) and DOB (and FG) will be turned off (high). This output state is held till the magnetic flux density reversal falls below BRP causing DO to be turned off (high) and DOB (and FG) turned on (low).

AH211 is available in TO-94 (SIP-4L) package.

**Features**

- On-Chip Hall Sensor
- 3.5V to 16V Supply Voltage
- 400mA (avg) Output Sink Current
- -20°C to 85°C Operating Temperature
- Built-in FG Output
- Low Profile TO-94 (SIP-4L) Package
- ESD Rating: 600V (Machine Model)

**Applications**

- Dual-Coil Brushless DC Motor
- Dual-Coil Brushless DC Fan
- Revolution Counting
- Speed Measurement



Figure 1. Package Type of AH211

**TWO PHASE HALL EFFECT LATCH WITH FG OUTPUT**

**AH211**

**Pin Configuration**

Z4 Package  
(TO-94)

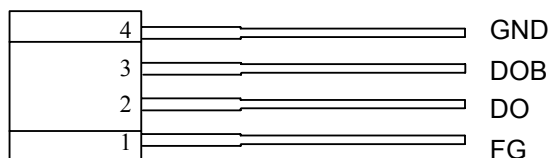

Figure 2. Pin Configuration of AH211 (Front View)

**Pin Description**

Pin Number	Pin Name	Function
1	FG	Frequency Generation
2	DO	Output 1
3	DOB	Output 2
4	GND	Ground

**TWO PHASE HALL EFFECT LATCH WITH FG OUTPUT**

**AH211**

**Functional Block Diagram**

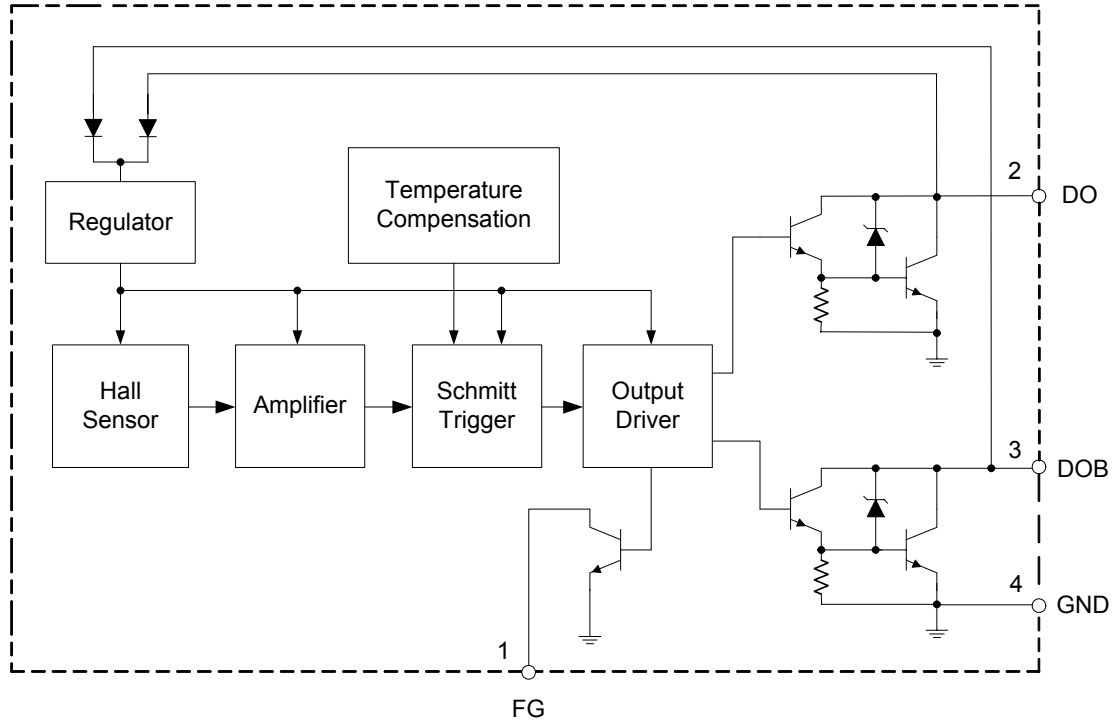
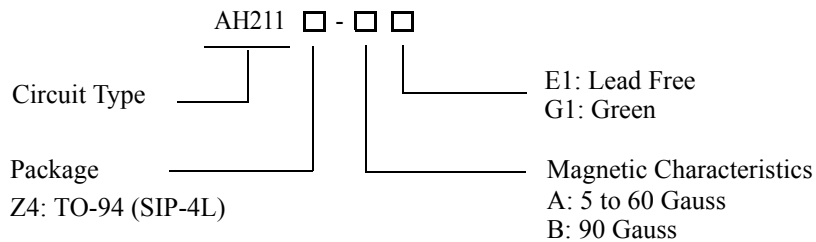

Figure 3. Functional Block Diagram of AH211

**Ordering Information**



Package	Temperature Range	Part Number		Marking ID		Packing Type
		Lead Free	Green	Lead Free	Green	
TO-94	-20 to 85 °C	AH211Z4-AE1	AH211Z4-AG1	AH211	AH211Z4-G1	Bulk
		AH211Z4-BE1	AH211Z4-BG1	AH211	AH211Z4-G1	Bulk

BCD Semiconductor's Pb-free products, as designated with "E1" suffix in the part number, are RoHS compliant. Products with "G1" suffix are available in green package.

**TWO PHASE HALL EFFECT LATCH WITH FG OUTPUT****AH211****Absolute Maximum Ratings (Note 1)** $(T_A=25^{\circ}\text{C})$ 

Parameter	Symbol	Value	Unit
Supply Voltage	$V_{CC}$	20	V
Magnetic Flux Density	B	Unlimited	Gauss
Output Current	Continuous	400	mA
	Hold	600	mA
	Peak (Start up)	800	mA
FG Voltage	$V_{FG}$	30	V
FG Current	$I_{FG}$	20	mA
Power Dissipation	$P_D$	550	mW
Thermal Resistance	Die to Atmosphere	$\theta_{JA}$	227 $^{\circ}\text{C}/\text{W}$
	Die to Package Case	$\theta_{JC}$	49 $^{\circ}\text{C}/\text{W}$
Storage Temperature	$T_{STG}$	-50 to 150	$^{\circ}\text{C}$
ESD (Machine Model)		600	V
ESD (Human Body Model)		6000	V

Note 1: Stresses greater than those listed under "Absolute Maximum Ratings" may cause permanent damage to the device. These are stress ratings only, and functional operation of the device at these or any other conditions beyond those indicated under "Recommended Operating Conditions" is not implied. "Absolute Maximum Ratings" for extended period may affect device reliability.

**Recommended Operating Conditions** $(T_A=25^{\circ}\text{C})$ 

Parameter	Symbol	Min	Max	Unit
Supply Voltage	$V_{CC}$	3.5	16	V
Ambient Temperature	$T_A$	-20	85	$^{\circ}\text{C}$



**TWO PHASE HALL EFFECT LATCH WITH FG OUTPUT**

**AH211**

**Electrical Characteristics**

( $T_A=25^{\circ}C$ ,  $V_{CC}=14V$ , unless otherwise specified)

Parameter	Symbol	Test Condition	Min	Typ	Max	Unit
Output Saturation Voltage	$V_{SAT}$	B>150Gauss, $V_{CC}=3.5V$ , $V_{DOB}=V_{CC}$ , $I_{DO}=100mA$ (or B<-150Gauss, $V_{CC}=3.5V$ , $V_{DO}=V_{CC}$ , $I_{DOB}=100mA$ )		1.1		V
		B>150Gauss, $V_{DOB}=V_{CC}$ , $I_{DO}=400mA$ (or B<-150Gauss, $V_{DO}=V_{CC}$ , $I_{DOB}=400mA$ )		1.05	1.3	V
FG Saturation Voltage	$V_{SATF}$	B<-150Gauss, $V_{DO}=V_{CC}$ , $I_{FG}=20mA$		0.35	0.6	V
FG Leakage Current	$I_{OLF}$	B>150Gauss, $V_{DOB}=V_{CC}$ , $V_{FG}=16V$		0.1	10	$\mu A$
Supply Current	$I_{CC}$	B>150Gauss, $V_{DOB}=V_{CC}$ , (or B<-150Gauss, $V_{DO}=V_{CC}$ )		4	8	mA
Output Rise Time	$t_r$	$R_L=1k\Omega$ , $C_L=10pF$		3.0	10	$\mu s$
Output Fall Time	$t_f$	$R_L=1k\Omega$ , $C_L=10pF$		0.3	1.0	$\mu s$
Switch Time Differential	$\Delta t$	$R_L=1k\Omega$ , $C_L=10pF$		3.0	10	$\mu s$
Output Zener Breakdown Voltage	$V_Z$			31		V

**Magnetic Characteristics**

( $T_A=25^{\circ}C$ )

Parameter	Symbol	Grade	Min	Typ	Max	Unit
Operating Point	$B_{OP}$	A	5	30	60	Gauss
		B			90	Gauss
Releasing Point	$B_{RP}$	A	-60	-30	-5	Gauss
		B	-90			Gauss
Hysteresis	$B_{HYS}$			60		Gauss

**TWO PHASE HALL EFFECT LATCH WITH FG OUTPUT**

**AH211**

**Magnetic Characteristics (Continued)**

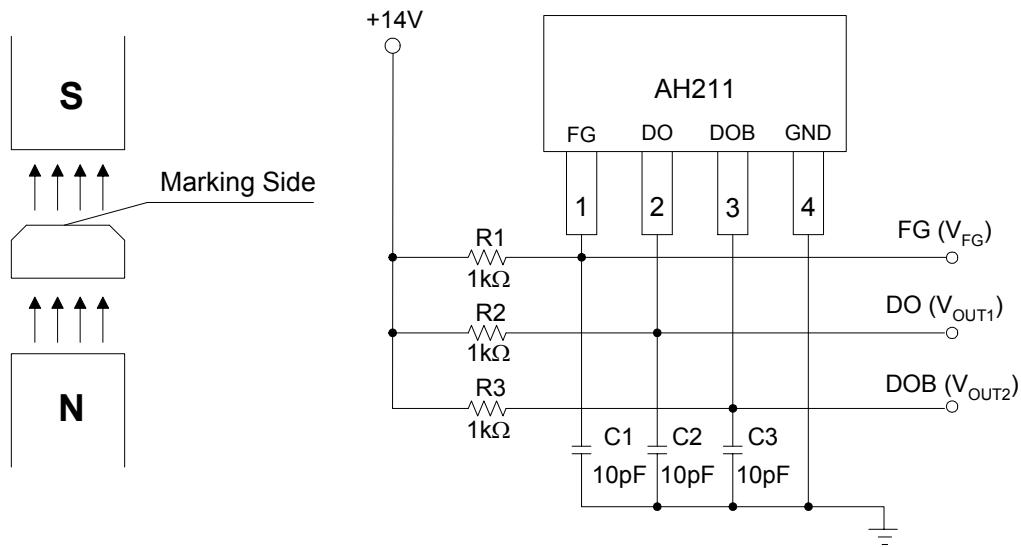

Figure 4. Basic Test Circuit

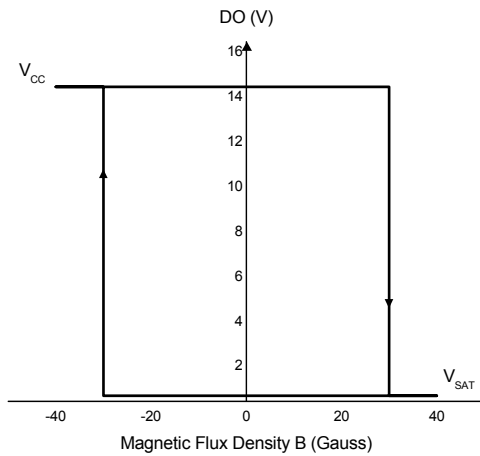

Figure 5.  $V_{DO}$  vs. Magnetic Flux Density

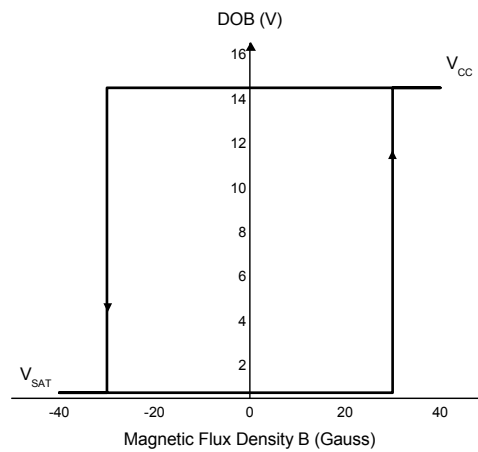

Figure 6.  $V_{DOB}$  vs. Magnetic Flux Density



**TWO PHASE HALL EFFECT LATCH WITH FG OUTPUT**

**AH211**

**Typical Performance Characteristics**

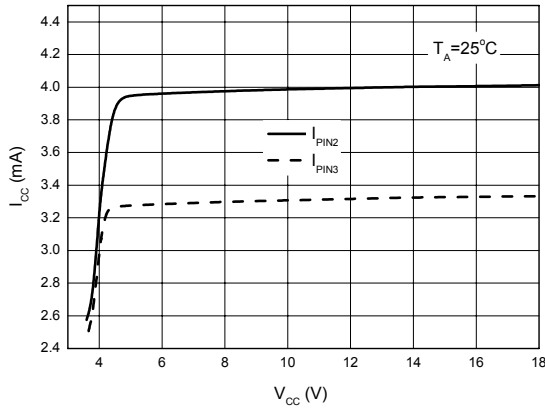

Figure 7.  $I_{CC}$  vs.  $V_{CC}$

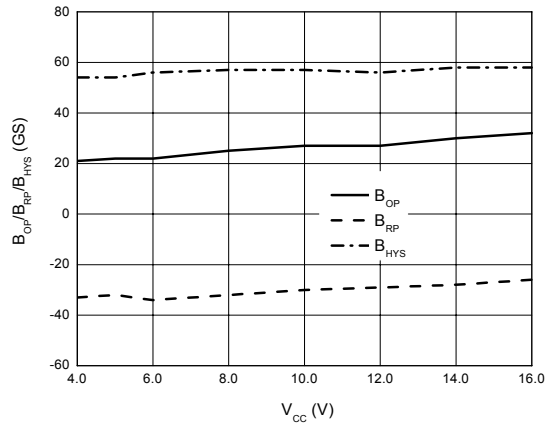

Figure 8.  $B_{OP}/B_{RP}/B_{HYS}$  vs.  $V_{CC}$

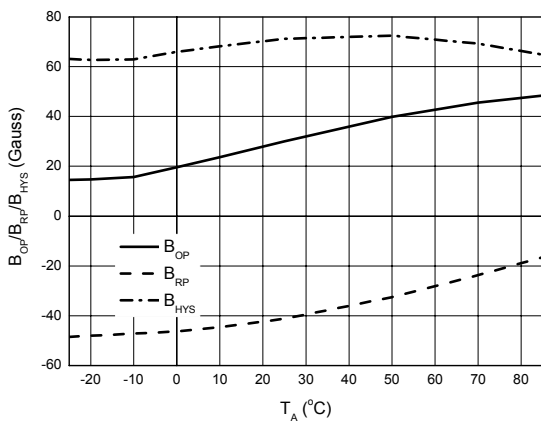

Figure 9.  $B_{OP}/B_{RP}/B_{HYS}$  vs. Ambient Temperature

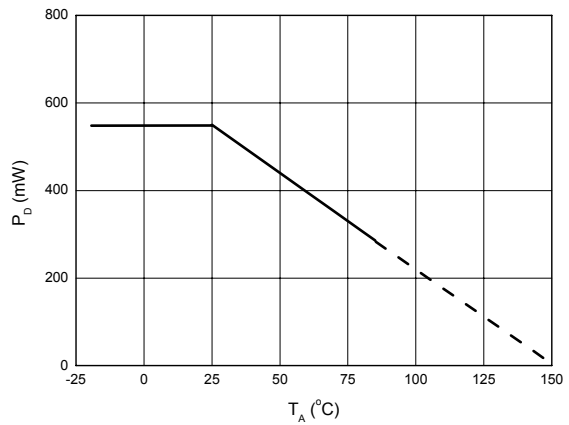

Figure 10.  $P_D$  vs. Ambient Temperature



**TWO PHASE HALL EFFECT LATCH WITH FG OUTPUT**

**AH211**

**Typical Performance Characteristics (Continued)**

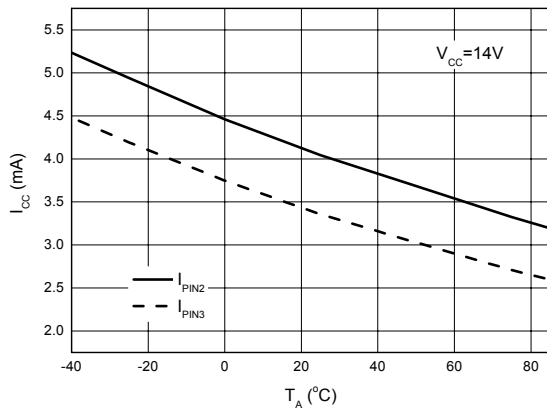

Figure 11. Supply Current vs. Ambient Temperature

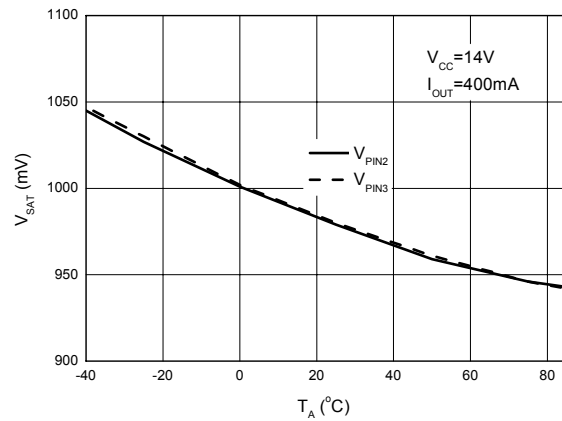

Figure 12.  $V_{SAT}$  vs. Ambient Temperature

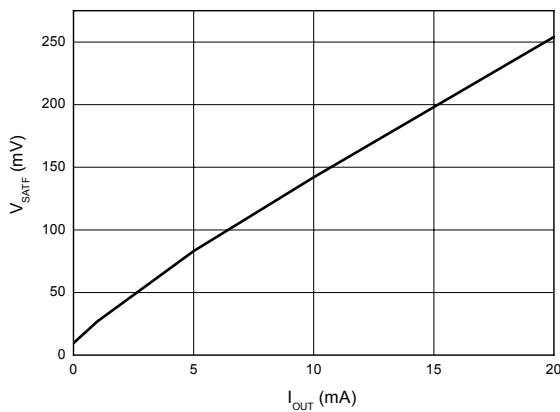

Figure 13. FG Saturation Voltage vs. Output Current

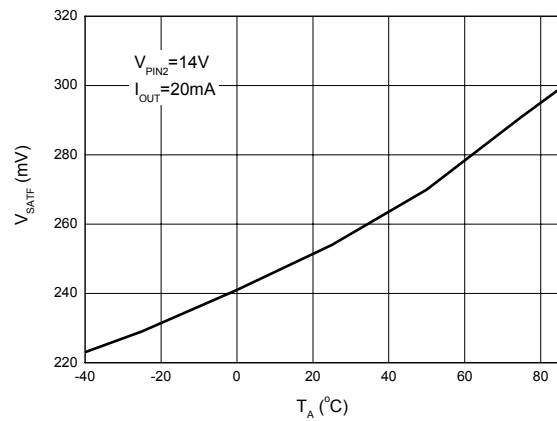

Figure 14. FG Saturation Voltage vs. Ambient Temperature



**TWO PHASE HALL EFFECT LATCH WITH FG OUTPUT**

**AH211**

**Application Information**

Figure 15 is the typical application circuit for AH211. Usually, there are three wires for fan connection: the red is input of power supply; the yellow is the output of FG; the black is the ground. R1 is an external pull-up resistor for the use of measuring FG signal from fan. The value of R1 could be decided by the transistor saturation voltage ( $V_{ON}$ ), sink current ( $I_{FG}$ ), and pull-up voltage ( $V_{DD}$ ). The calculation formula is:

$$R1 = (V_{DD} - V_{ON}) / I_{FG}$$

For example:

$V_{DD} = 5V$  for TTL level.

If saturation voltage is 0.6V (IC specification)

$I_{FG} = 20mA$  ( $\leq 20mA$ ), then  $R1 = 220\Omega$ ;

If saturation voltage is 0.1V,  $I_{FG} = 1mA$  ( $= < 20mA$ ), the value of  $R1 = 4.9k\Omega$

According AH211's specification, if  $V_{DD} = 5V$ , R1 must be larger than  $220\Omega$

D1 is the reverse protection diode. If the red and black wires reversely connected, the current will flow from the ground via IC and coils L1 and L2 to power supply. Under such circumstances, the IC and coils are easy to be burned out. Therefore, the reverse protection diode D1 is necessary. However, D1 will also cause an extra voltage drop on the supply voltage.

C1 is a capacitor to reduce the ripple noise caused by the transient of the output stages. The amplitude of the ripple noise depends on the coil impedance and its characteristics.

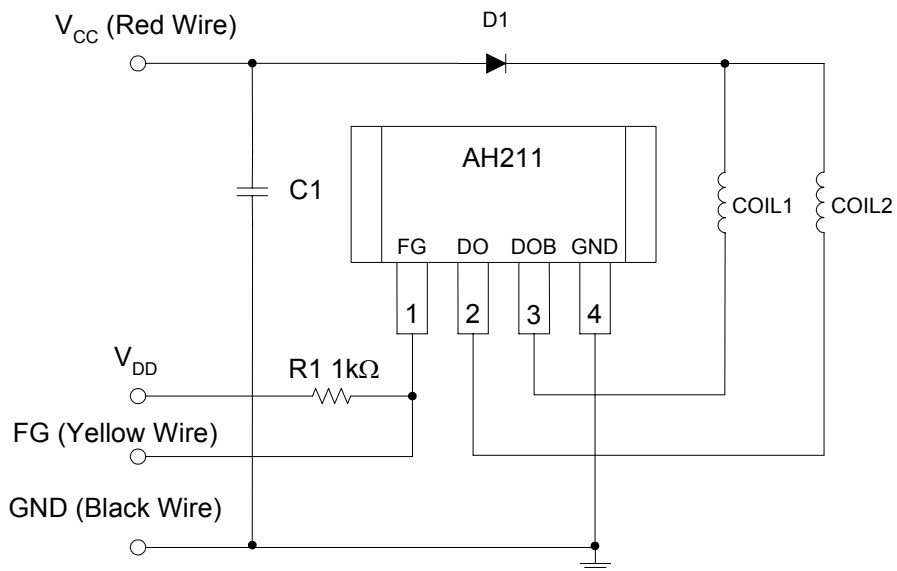

Figure 15. AH211 Typical Application Circuit



**TWO PHASE HALL EFFECT LATCH WITH FG OUTPUT**

**AH211**

**Mechanical Dimensions**

**TO-94**

**Unit: mm(inch)**

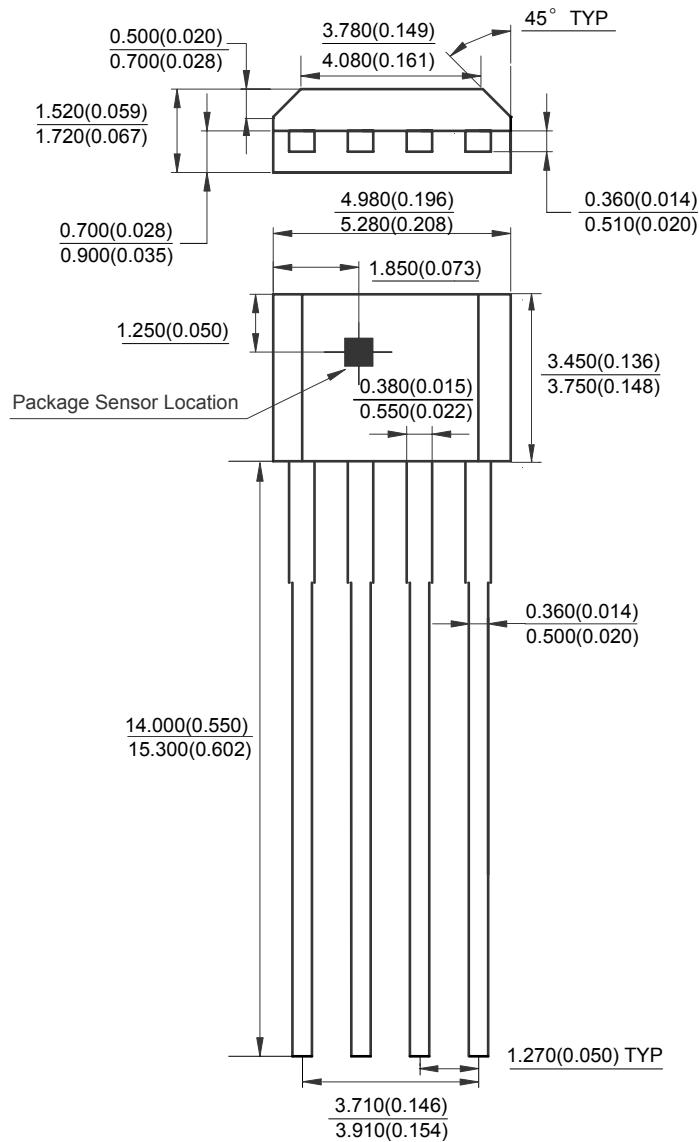



## **BCD Semiconductor Manufacturing Limited**

<http://www.bcdsemi.com>

### **IMPORTANT NOTICE**

BCD Semiconductor Manufacturing Limited reserves the right to make changes without further notice to any products or specifications herein. BCD Semiconductor Manufacturing Limited does not assume any responsibility for use of any its products for any particular purpose, nor does BCD Semiconductor Manufacturing Limited assume any liability arising out of the application or use of any its products or circuits. BCD Semiconductor Manufacturing Limited does not convey any license under its patent rights or other rights nor the rights of others.

---

#### **MAIN SITE**

##### **- Headquarters**

##### **BCD Semiconductor Manufacturing Limited**

No. 1600, Zi Xing Road, Shanghai ZiZhu Science-based Industrial Park, 200241, China  
Tel: +86-21-24162266, Fax: +86-21-24162277

##### **- Wafer Fab**

##### **Shanghai SIM-BCD Semiconductor Manufacturing Co., Ltd.**

800 Yi Shan Road, Shanghai 200233, China  
Tel: +86-21-6485 1491, Fax: +86-21-5450 0008

#### **REGIONAL SALES OFFICE**

##### **Shenzhen Office**

##### **Shanghai SIM-BCD Semiconductor Manufacturing Co., Ltd., Shenzhen Office**

Unit A Room 1203, Skyworth Bldg., Gaoxin Ave. 1.S., Nanshan District, Shenzhen, China  
Tel: +86-755-8826 7951  
Fax: +86-755-8826 7865

##### **Taiwan Office**

##### **BCD Semiconductor (Taiwan) Company Limited**

4F, 298-1, Rui Guang Road, Nei-Hu District, Taipei, Taiwan  
Tel: +886-2-2656 2808  
Fax: +886-2-2656 2806

##### **USA Office**

##### **BCD Semiconductor Corp.**

30920 Huntwood Ave. Hayward, CA 94544, USA  
Tel : +1-510-324-2988  
Fax: +1-510-324-2788

## Данный компонент на территории Российской Федерации

### Вы можете приобрести в компании MosChip.

Для оперативного оформления запроса Вам необходимо перейти по данной ссылке:

<http://moschip.ru/get-element>

Вы можете разместить у нас заказ для любого Вашего проекта, будь то серийное производство или разработка единичного прибора.

В нашем ассортименте представлены ведущие мировые производители активных и пассивных электронных компонентов.

Нашей специализацией является поставка электронной компонентной базы двойного назначения, продукции таких производителей как XILINX, Intel (ex.ALTERA), Vicor, Microchip, Texas Instruments, Analog Devices, Mini-Circuits, Amphenol, Glenair.

Сотрудничество с глобальными дистрибьюторами электронных компонентов, предоставляет возможность заказывать и получать с международных складов практически любой перечень компонентов в оптимальные для Вас сроки.

На всех этапах разработки и производства наши партнеры могут получить квалифицированную поддержку опытных инженеров.

Система менеджмента качества компании отвечает требованиям в соответствии с ГОСТ Р ИСО 9001, ГОСТ РВ 0015-002 и ЭС РД 009

### Офис по работе с юридическими лицами:

105318, г.Москва, ул.Щербаковская д.3, офис 1107, 1118, ДЦ «Щербаковский»

Телефон: +7 495 668-12-70 (многоканальный)

Факс: +7 495 668-12-70 (доб.304)

E-mail: [info@moschip.ru](mailto:info@moschip.ru)

Skype отдела продаж:

moschip.ru

moschip.ru\_4

moschip.ru\_6

moschip.ru\_9