

# MULTILAYER FERRITE CHIP INDUCTOR

AIML-0603HC

RoHS/RoHS II Compliant

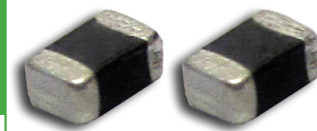

1.6 x 0.8 x 0.8mm

## FEATURES:

- Monolithic structure for higher reliability, compact size, & lightweight
- Magnetically shielded design to eliminate cross coupling
- Excellent solderability and heat resistance for reflow soldering
- Perfect shape for PCB mounting with no polarity

## APPLICATIONS:

- DC/DC converter circuit for Front End Module such as Skyworks Solution
- Portable AV equipments such as Digital Camera, Camcorder remote Control.

## STANDARD SPECIFICATIONS:

### PARAMETERS

ABRACON P/N:	AIML-0603HC-xxx
Operating temperature:	-55°C to + 125°C
Storage temperature:	-55°C to + 125°C

Part No.	L( $\mu$ H)	Tolerance	Test Freq.	SRF(MHz)	DCR( $\Omega$ )	Isat(mA)	Irms(mA)
		(%)	(MHz)	(min)	$\pm 30\%$	(max)	(max)
AIML-0603HC-3R3M	3.3	M	1	70	0.40	80	600
AIML-0603HC-4R7M	4.7	M	1	50	0.50	60	500

### Test Conditions and equipments

**L, Q:** HP4291 Impedance Analyzer

**DCR:** HP4263A LCR meter

**SRF:** HP4291 Impedance analyzer

**Irms:** HP4291 Impedance Analyzer, DC power HP6632 and Adapter HP16200.

Current when temperature of the product reaches +40°C.

**Isat:** HP4291 Impedance Analyzer, DC power HP6632 and Adapter HP16200.  $\Delta L/L$  (initial)  $\geq -30\%$

## ELECTRICAL CHARACTERISTICS CURVES

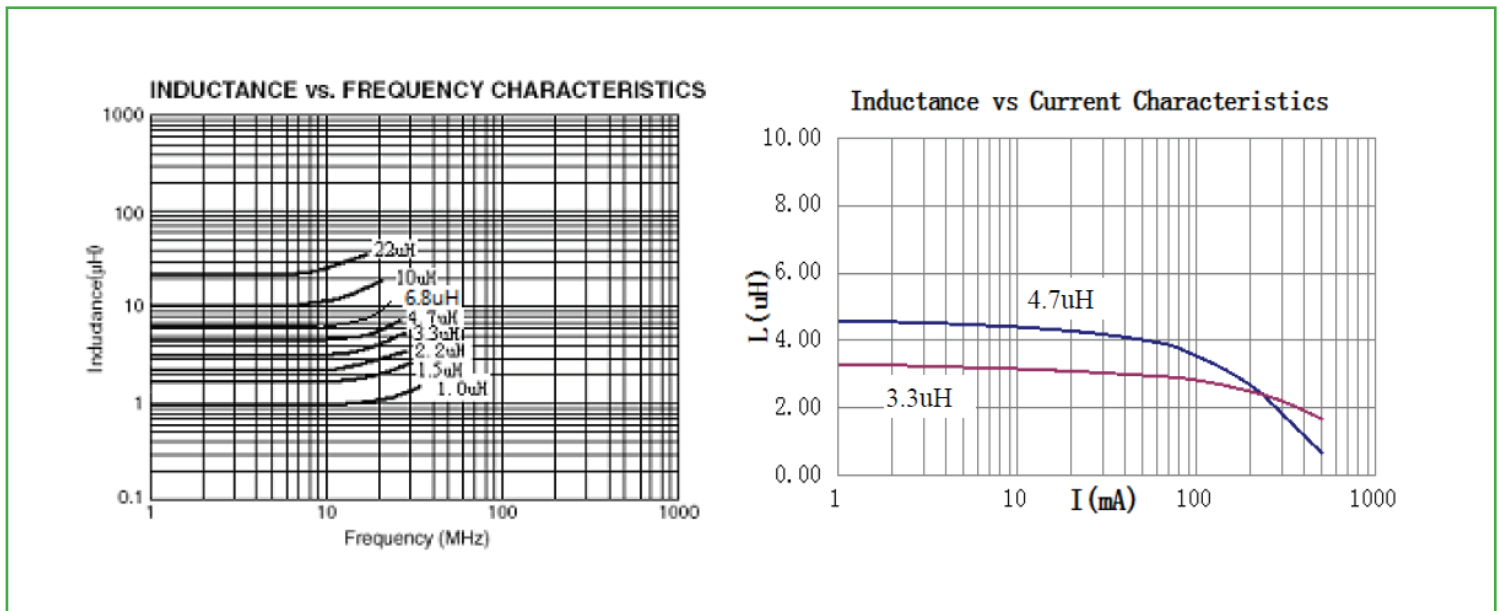

# MULTILAYER FERRITE CHIP INDUCTOR

AIML-0603HC

RoHS/RoHS II Compliant

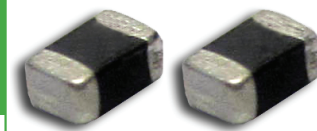

1.6 x 0.8 x 0.8mm

## OPTIONS AND PART IDENTIFICATION:

AIML-0603HC--

### Inductance Code

Please refer to the table above

### Tolerance

M:  $\pm 20\%$

### Packaging

T: Tape and Reel  
(4kpcs / reel)

## OUTLINE DRAWING:

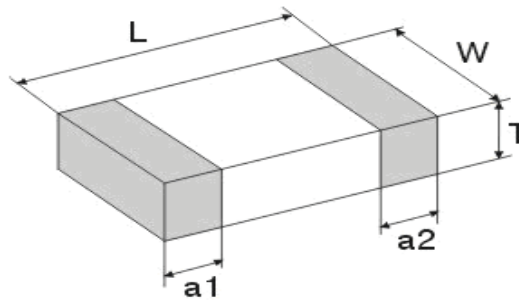

Dimension: mm

L	W	T	a1,a2
1.60 $\pm$ 0.15	0.80 $\pm$ 0.15	0.80 $\pm$ 0.15	0.30 $\pm$ 0.20

## MATERIAL:

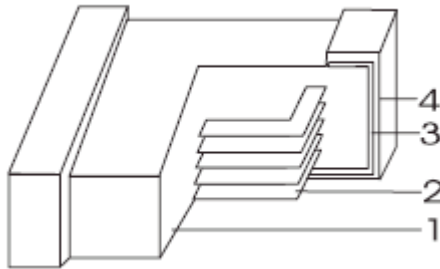

Part Name	Material
1 Base Material	Ferrite (Ni-Cu-Zn series)
2 Internal Conductor	Ag
3 Terminal Electrode	Ag
4 Terminal Electrode	Ni-Sn

## REFLOW PROFILE:

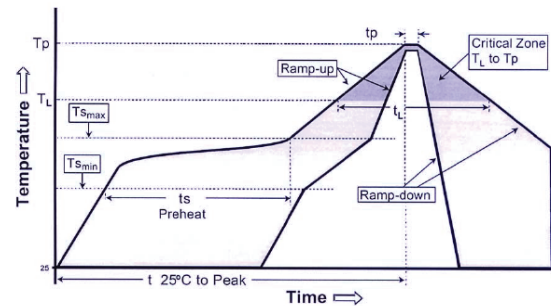

Profile Feature	Lead-Free Assembly
Average Ramp-Up Rate (T <sub>max</sub> to T <sub>p</sub> )	3°C /second max.
Preheat	
- Temperature Min (T <sub>min</sub> )	150 °C
- Temperature Max (T <sub>max</sub> )	200 °C
- Time (t <sub>min</sub> to t <sub>max</sub> ) min to t <sub>max</sub> )	60-180 seconds
Time maintained above:	
- Temperature (T <sub>L</sub> )	217 °C
- Time (t <sub>L</sub> )	60-150 seconds
Peak/Classification Temperature (T <sub>p</sub> )	260 °C
Peak/Classification Time (T <sub>p</sub> )	3-4 seconds
Time within 5 °C of actual Peak Temperature (t <sub>p</sub> )	20-40 seconds
Ramp-Down Rate	6°C/second max.
Time 25 °C to Peak Temperature	8 minutes max.

ABRACON IS  
ISO 9001:2008  
CERTIFIED



**ABRACON**  
CORPORATION

Visit [www.abracon.com](http://www.abracon.com) for Terms & Conditions of Sale  
30332 Esperanza, Rancho Santa Margarita, California 92688  
tel 949-546-8000 | fax 949-546-8001 | [www.abracon.com](http://www.abracon.com)

Revised: 01.10.14

# MULTILAYER FERRITE CHIP INDUCTOR

AIML-0603HC

RoHS/RoHS II Compliant

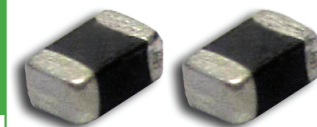

1.6 x 0.8 x 0.8mm

## TAPE & REEL:

### Packing

T: 4,000pcs / reel

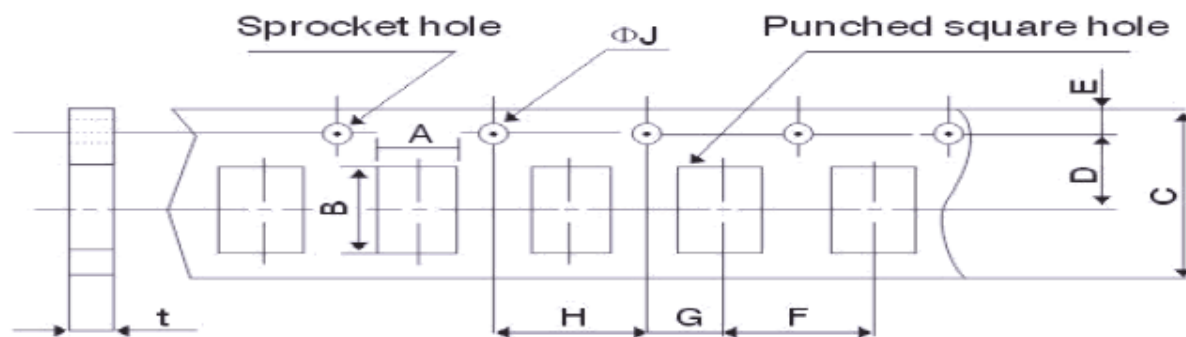

A	B	C	D	E	F	G	H	ΦJ	t(max)
1.05±0.15	1.9±0.15	8.0±0.3	3.5±0.05	1.75±0.1	4.0±0.1	2.0±0.05	4.0±0.1	1.5+0.1/-0	1.0±0.05

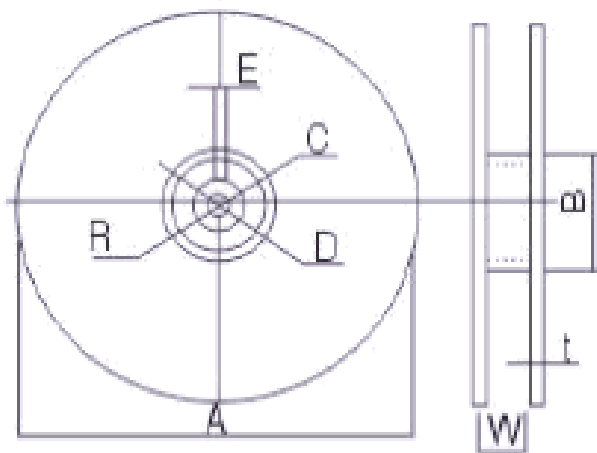

A	178±2
B	60±2
C	13.0±0.5
D	21.0±0.8
E	2.0±0.5
W	10.0±1.15
t	1.2±0.2
R	1.0±0.25

Dimension: mm

**ATTENTION:** Abracon Corporation's products are COTS – Commercial-Off-The-Shelf products; suitable for Commercial, Industrial and, where designated, Automotive Applications. Abracon's products are not specifically designed for Military, Aviation, Aerospace, Life-dependant Medical applications or any application requiring high reliability where component failure could result in loss of life and/or property. For applications requiring high reliability and/or presenting an extreme operating environment, written consent and authorization from Abracon Corporation is required. Please contact Abracon Corporation for more information.

ABRACON IS  
ISO 9001:2008  
CERTIFIED



**ABRACON**  
CORPORATION

Visit [www.abracon.com](http://www.abracon.com) for Terms & Conditions of Sale  
30332 Esperanza, Rancho Santa Margarita, California 92688  
tel 949-546-8000 | fax 949-546-8001 | [www.abracon.com](http://www.abracon.com)

Revised: 01.10.14

## Данный компонент на территории Российской Федерации

### Вы можете приобрести в компании MosChip.

Для оперативного оформления запроса Вам необходимо перейти по данной ссылке:

<http://moschip.ru/get-element>

Вы можете разместить у нас заказ для любого Вашего проекта, будь то серийное производство или разработка единичного прибора.

В нашем ассортименте представлены ведущие мировые производители активных и пассивных электронных компонентов.

Нашей специализацией является поставка электронной компонентной базы двойного назначения, продукции таких производителей как XILINX, Intel (ex.ALTERA), Vicor, Microchip, Texas Instruments, Analog Devices, Mini-Circuits, Amphenol, Glenair.

Сотрудничество с глобальными дистрибьюторами электронных компонентов, предоставляет возможность заказывать и получать с международных складов практически любой перечень компонентов в оптимальные для Вас сроки.

На всех этапах разработки и производства наши партнеры могут получить квалифицированную поддержку опытных инженеров.

Система менеджмента качества компании отвечает требованиям в соответствии с ГОСТ Р ИСО 9001, ГОСТ РВ 0015-002 и ЭС РД 009

### Офис по работе с юридическими лицами:

105318, г.Москва, ул.Щербаковская д.3, офис 1107, 1118, ДЦ «Щербаковский»

Телефон: +7 495 668-12-70 (многоканальный)

Факс: +7 495 668-12-70 (доб.304)

E-mail: [info@moschip.ru](mailto:info@moschip.ru)

Skype отдела продаж:

moschip.ru

moschip.ru\_4

moschip.ru\_6

moschip.ru\_9