

SERIES FC-335
RELAY NON-LATCHING
3PST/NO (DM)
35A/28Vdc, 115 Vac – 50/60Hz, 400Hz

PRODUCT FACTS:

- Non-latching Hermetically Sealed Relay.
- Corrosion protected metal can.
- All welded construction.
- 28 Vdc & 115 Vac coils available.
- Weight 0.5 lbs Max. (227 Grams Max).
- Designed and built in accordance to MIL- PRF-6106.
- 3-Pole 35A Contacts (Form X), Switching in 1.5 inch³.
- Main contacts are suitable for use in 360-800 Hz variable frequency applications.



PRODUCT DATA SHEET

29-Nov-2017 Rev

PH. 828-338-1087 FAX 828-338-1103

1396 CHARLOTTE HIGHWAY, FAIRVIEW, NC 28730

SERIES FC-335

Dimensions shown for reference Only. Specifications subject to change.

CAGE CODE

SCALE

NONE

SHEET

1 of 6

GENERAL CHARACTERISTICS

Temperature range	-70° C to +125° C
Altitude	80,000 feet
Dielectric strength at sea level	
- Coil to case	1250 Vrms
- All other points	1500 Vrms
Dielectric strength at altitude 25000 m (80,000 ft) (all points)	500 Vrms
Initial insulation resistance at 500 Vdc	100 MΩ min.
Initial insulation after life or environmental test	50 MΩ min.
Sinusoidal vibration	10g / 5 to 1000 Hz
Shock	50g / 11 ms
Operate time at nominal voltage	
AC	25 ms max.
DC	20 ms max.
Release time at nominal voltage	
AC	50 ms max.
DC	10 ms max.
Bounce Time at Nominal voltage	2 ms max.
Contact voltage drop at nominal current	
-initial value	150 mV max.
-after life	175 mV max.

COIL CHARACTERISTICS

CODE	115 Vac 50/60 Hz	115 Vac 400 Hz	28 Vdc	28 Vdc (Suppressed)
Nominal operating voltage	115	115	28	28
Maximum operating voltage	122	122	32	32
Maximum pick-up voltage over temperature range	95	95	18	18
Maximum pick-up voltage over temperature range (Continuous Current test)	108	108	22.5	22.5
Drop-out voltage over temperature range	5.0	5.0	1.5	1.5
Coil current at +25° C (amperes)	.06	.055	-	-
Coil Resistance - DC Coils (*)	-	-	160	160
Back EMF Suppression to (VDC)	-	-	-	42

For other coil voltages, consult factory.

- DC Coil Resistance ± 10% at 25°C.



PRODUCT DATA SHEET

29-Nov-2017 Rev

PH. 828-338-1087 FAX 828-338-1103

1396 CHARLOTTE HIGHWAY, FAIRVIEW, NC 28730

SERIES FC-335

Dimensions shown for reference
Only. Specifications subject to
change.

CAGE CODE

SCALE

NONE

SHEET

2 of 6

CONTACT ELECTRICAL CHARACTERISTICS

Type of Load	Life (Min.) Cycles X10 ³	CONTACT RATING (A)				
		28Vdc	25A, 230 VAC		35A, 115 VAC	
			400 Hz	50/60 Hz	400Hz	50/60Hz
Resistive	50	35	25	25	35	35
Inductive	10	15	25	25	25	25
Motor	50	20	20	12	20	12
Lamp	50	10	10	10	10	10
Mechanical life reduced current	200	6.3	6.3	6.3	6.3	6.3

PART NUMBERING SYSTEM

CII Part Number	Terminal	Mounting	Coil
FC-335-CW3	Solder Hook	Stud	28 Vdc
FC-335-SY3	Screw	Bracket	28 Vdc
FC-335-CW4	Solder Hook	Stud	28 Vdc (Suppressed)
FC-335-SY4	Screw	Bracket	28 Vdc (Suppressed)
FC-335-CW9	Solder Hook	Stud	115 Vac, 50/60 Hz
FC-335-SY9	Screw	Bracket	115 Vac, 50/60 Hz
FC-335-CW8	Solder Hook	Stud	115 Vac, 400 Hz
FC-335-SY8	Screw	Bracket	115 Vac, 400 Hz

* SPECIALS AVAILABLE UPON REQUEST, PLEASE CONTACT FACTORY.



PRODUCT DATA SHEET

29-Nov-2017 Rev

PH. 828-338-1087 FAX 828-338-1103
1396 CHARLOTTE HIGHWAY, FAIRVIEW, NC 28730

SERIES FC-335

Dimensions shown for reference
Only. Specifications subject to
change.

CAGE CODE

SCALE

NONE

SHEET

3 of 6

CONFIGURATION

Style 1: Solder Hook Terminals



MOUNTING LAYOUT



Note:

Tolerances ± 0.010 " unless other specified.



PRODUCT DATA SHEET

29-Nov-2017 Rev

PH. 828-338-1087 FAX 828-338-1103

1396 CHARLOTTE HIGHWAY, FAIRVIEW, NC 28730

SERIES FC-335

Dimensions shown for reference
Only. Specifications subject to
change.

CAGE CODE

SCALE

NONE

SHEET

4 of 6

CONFIGURATION

Style 2: Screw Terminals

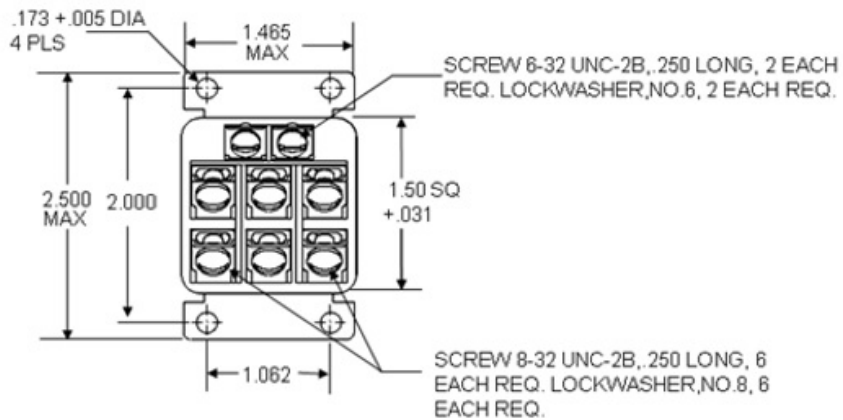

MOUNTING LAYOUT

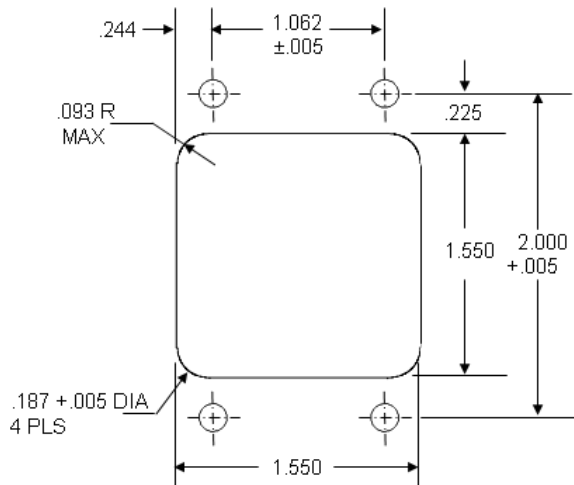

Note:

Tolerances $\pm .010$ " unless otherwise specified.



PRODUCT DATA SHEET

29-Nov-2017 Rev

PH. 828-338-1087 FAX 828-338-1103
1396 CHARLOTTE HIGHWAY, FAIRVIEW, NC 28730

SERIES FC-335

Dimensions shown for reference Only. Specifications subject to change.

CAGE CODE

SCALE

NONE

SHEET

5 of 6

SCHEMATIC DIAGRAM



CIRCUIT DIAGRAM A

(DC UNSUPPRESSED AND AC COILS)



CIRCUIT DIAGRAM B

(DC SUPPRESSED COILS)



PRODUCT DATA SHEET

29-Nov-2017 Rev

PH. 828-338-1087 FAX 828-338-1103
1396 CHARLOTTE HIGHWAY, FAIRVIEW, NC 28730

SERIES FC-335

Dimensions shown for reference
Only. Specifications subject to
change.

CAGE CODE

SCALE

NONE

SHEET

6 of 6

Данный компонент на территории Российской Федерации

Вы можете приобрести в компании MosChip.

Для оперативного оформления запроса Вам необходимо перейти по данной ссылке:

<http://moschip.ru/get-element>

Вы можете разместить у нас заказ для любого Вашего проекта, будь то серийное производство или разработка единичного прибора.

В нашем ассортименте представлены ведущие мировые производители активных и пассивных электронных компонентов.

Нашей специализацией является поставка электронной компонентной базы двойного назначения, продукции таких производителей как XILINX, Intel (ex.ALTERA), Vicor, Microchip, Texas Instruments, Analog Devices, Mini-Circuits, Amphenol, Glenair.

Сотрудничество с глобальными дистрибьюторами электронных компонентов, предоставляет возможность заказывать и получать с международных складов практически любой перечень компонентов в оптимальные для Вас сроки.

На всех этапах разработки и производства наши партнеры могут получить квалифицированную поддержку опытных инженеров.

Система менеджмента качества компании отвечает требованиям в соответствии с ГОСТ Р ИСО 9001, ГОСТ РВ 0015-002 и ЭС РД 009

Офис по работе с юридическими лицами:

105318, г.Москва, ул.Щербаковская д.3, офис 1107, 1118, ДЦ «Щербаковский»

Телефон: +7 495 668-12-70 (многоканальный)

Факс: +7 495 668-12-70 (доб.304)

E-mail: info@moschip.ru

Skype отдела продаж:

moschip.ru

moschip.ru_4

moschip.ru_6

moschip.ru_9