

MJTP SERIES 6MM & 4MM SMD TACT SWITCHES

FEATURES

- Numerous single pole-single throw momentary configurations.
- Excellent tactile feed-back (Snap dome).
- Ultra-compact size.
- Long operating life for high reliability.
- Molded-in terminals minimize wicking of flux or solder.

MATERIALS

Case:	High temperature 4/6 nylon.
Actuator:	High temperature 4/6 nylon.
Cover/Bracket:	PET film, tin plated brass or stainless steel.
Terminals:	Silver plated brass.
Shorting Contact:	Phosphor bronze or stainless steel with silver plating.
L.E.D. rating:	Forward voltage- 2.1 V (3.0 V Max.). Cont. fwd. current 20mA max. @ 25°C.

Gold plating available on contacts & terminals
- consult factory.

SPECIFICATIONS SUBJECT TO CHANGE WITHOUT NOTICE.

GENERAL SPECIFICATIONS

ELECTRICALS

Contact rating:	50 mA @ 12 VDC
Insulation resistance:	100 megohms min. (100 VDC)
Dielectric withstanding voltage:	250 VAC for 1 minute
Contact resistance:	100 milliohms max. @ 5 VDC, 10 mA
Electrical life:	100,000 cycles min. (1,000,000 cycles available - consult factory)
Contact bounce:	less than 10 msec.

MECHANICALS, THERMALS, ENVIRONMENTALS

Plunger travel:	.010" + .008", - .004" (0,25 +0,2, -0,1 mm)
Actuation force:	160 grams ±30 grams
Operating temperature range:	-20°C to +70°C
Storage temperature range:	-30°C to +80°C for 96 hours
Shock resistance:	30G per method 213, MIL-STD-202
Vibration resistance:	passes method 201, MIL-STD-202

SOLDERING (note - non-washable except for models indicated as 'process compatible').

IR reflow soldering:	240°C max. for 20 seconds max.
Wave soldering:	255°C max. for 5 seconds max.
Hand soldering:	320°C max. for 3.5 seconds max. (40 watt iron max.)

US # MJTP1106S

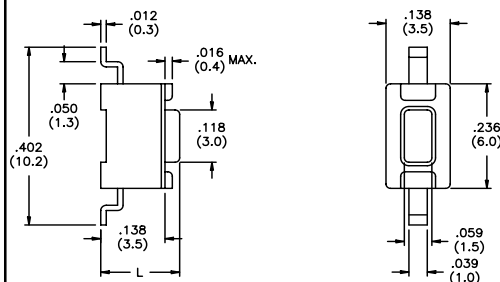

US Model No.	Dim. L (in./mm)
MJTP1106S	.169 (4,3)
MJTP1106SA	.197 (5,0)

Bulk packaged.

US # MJTP1106SATR

Same as above, except supplied on tape and reel as shown.

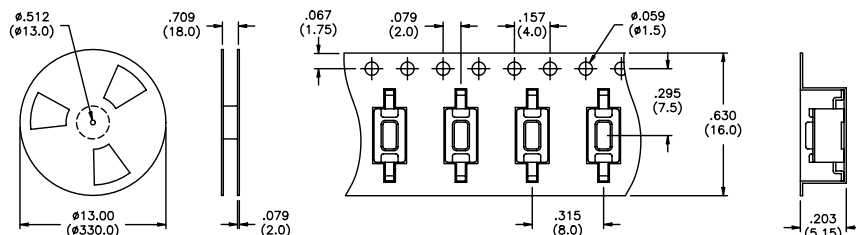

Tape & reel packaging - quantity 1800 per reel.

M

US # MJTP1122
Grounding

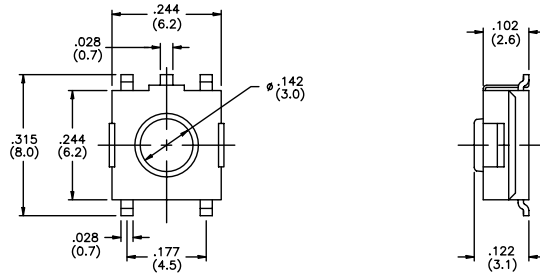

Bulk packaged.

US # MJTP1122A
Grounding

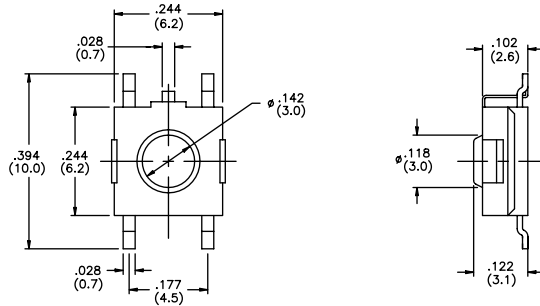

Bulk packaged.

US # MJTP1122B
EU # PHAP3374

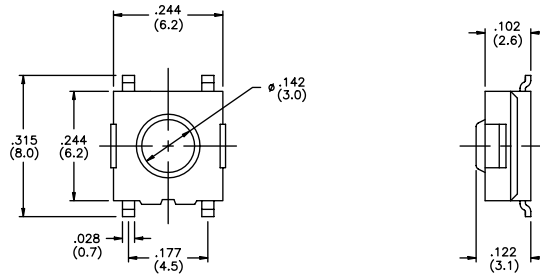

Bulk packaged.

US # MJTP1122TR,
MJTP1122BTR &
MJTP3374TR
EU # PHAP3374R

Same as above,
except supplied
on tape & reel
as shown.
Note -
MJTP1122A
not available on
tape & reel.

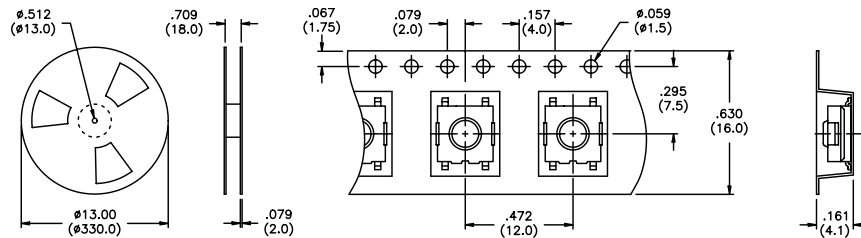

Tape & reel packaging - quantity 1500 per reel.

SPECIFICATIONS SUBJECT TO CHANGE WITHOUT NOTICE.

M

SPECIFICATIONS SUBJECT TO CHANGE WITHOUT NOTICE.

US # MJTP1125B

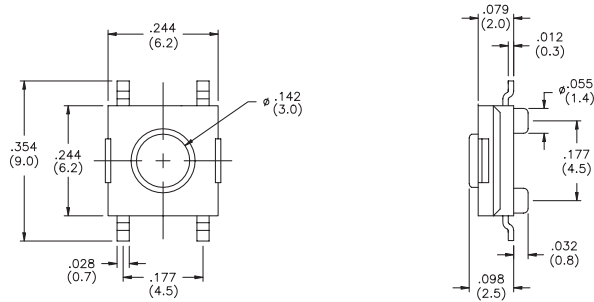

Bulk packaged.

New!

**US # MJTP1138
EU # PHAP3368**

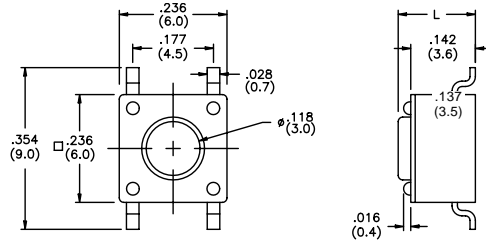

US Model No.	Dim. L (in./mm)	EU Model No.
MJTP1138	.170 (4,3)	PHAP3368
MJTP1138A	.197 (5,0)	PHAP3368A
MJTP1138B	.374 (9,5)	PHAP3368B
MJTP1138C	.315 (8,0)	PHAP3368C
MJTP1138D	.512 (13,0)	PHAP3368D
MJTP1138E	.287 (7,3)	PHAP3368E
MJTP1138F	.335 (8,5)	PHAP3368F
MJTP1138G	.275 (7,0)	N/A

Bulk packaged. Tubes available for some models consult factory.

SPECIFICATIONS SUBJECT TO CHANGE WITHOUT NOTICE.

US # MJTP1138TR & MJTP1138ATR

Same as above except supplied on tape & reel as shown.

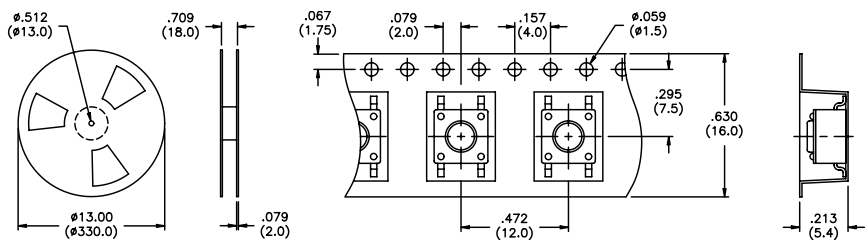

Tape & reel packaging - quantity 1200 per reel.

US # MJTP1140 EU # PHAP3390

4mm x 4mm

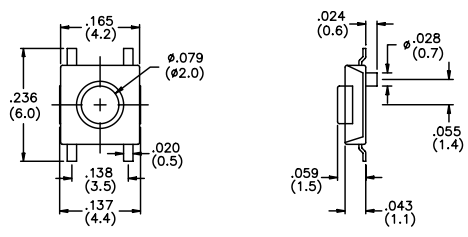

Bulk packaged.

US # MJTP1140A EU # PHAP3391

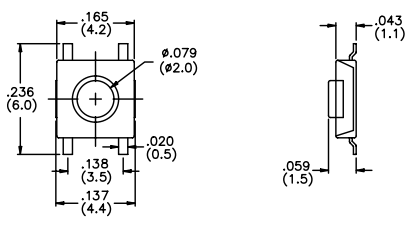

Bulk packaged.

US # MJTP1140TR & MJTP1140ATR EU # PHAP3390R & PHAP3391R

Same as above, except supplied on tape & reel as shown.

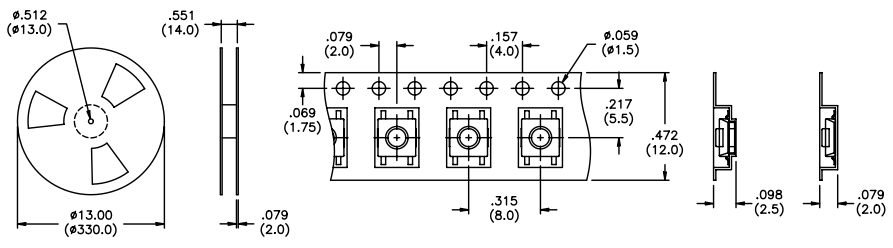

Tape & reel packaging - quantity 3400 per reel.

US # MJTP1162 EU # PHAP3371

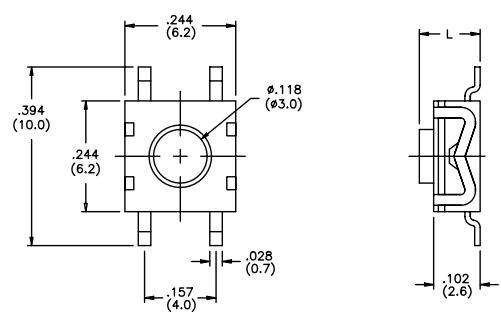

US Model No.	Dim. L (in./mm)	EU Model No.
MJTP1162	.102 (2,6)	PHAP3371
MJTP1162A	.134 (3,4)	PHAP3371A

Bulk packaged.

SPECIFICATIONS SUBJECT TO CHANGE WITHOUT NOTICE.

US # MJTP1162TR & MJTP1162ATR
EU # PHAP3371R & PHAP3371AR
 Same as above except supplied on tape & reel as shown.

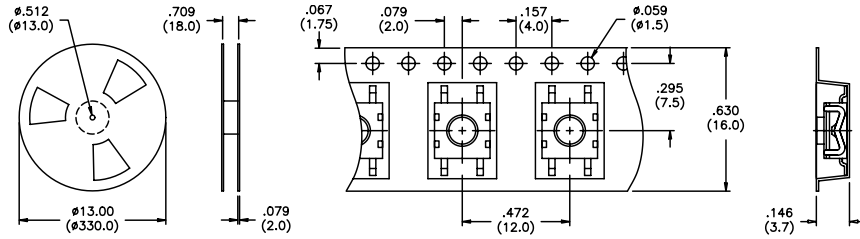

Tape & reel packaging - quantity 1600 per reel.

US # MJTPSJW66N
 Process compatible



New!

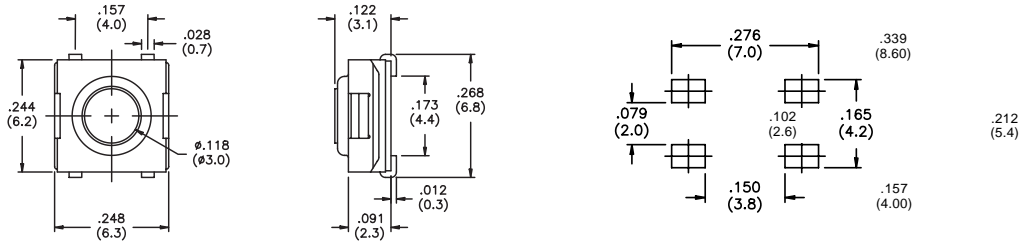

Bulk packaged.

US # MJTPSJW69N
 Process compatible



New!

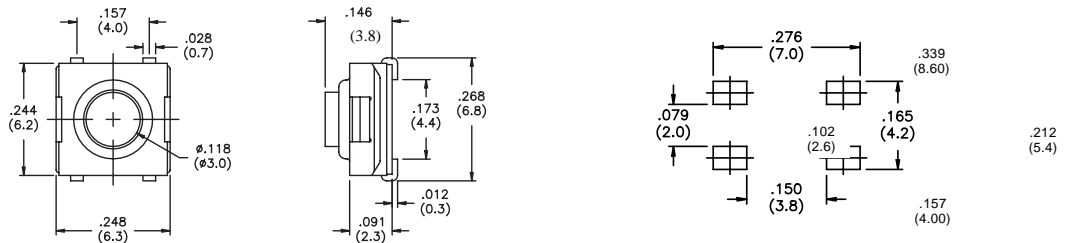

Bulk packaged.

US # MJTPSMW
 Process compatible

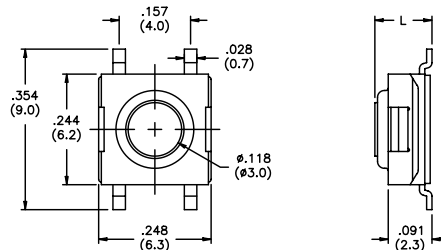

US Model No.	Dim. L (in./mm)
MJTPSMW	.122 (3,1)
MJTPSMWA	.091 (2,3)
MJTPSMWB	.146 (3,8)

Bulk packaged.

M

US # MJTPSMWTR & MJTPSMWATR, MJTPSMWBTR

Same as above except supplied on tape & reel as shown.

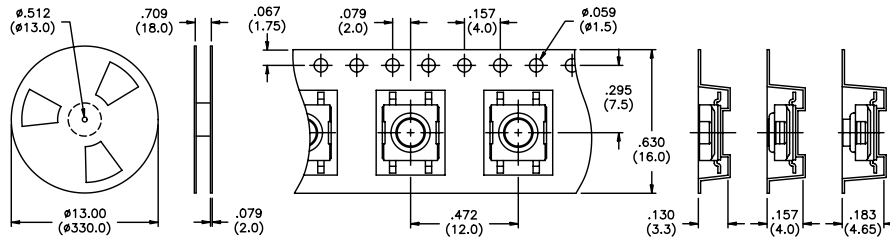

Tape & reel packaging - quantity 'MWTR' & 'MWATR' 2000 per reel, 'MWBTR' 1900 per reel.

SCHEMATICS

MJTP1122
 MJTP1125
 MJTP1137
 MJTP1138
 MJTP1140
 MJTP1162
 MJTPSJW66N
 MJTPSJW69N
 MJTPSMW

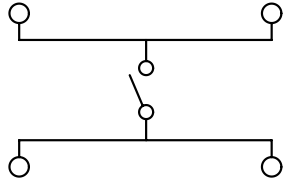

MJTP1106

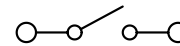

PRINTED CIRCUIT BOARD LAYOUTS

Layout tolerances; Linear: $\pm .004"$ ($\pm 0,1\text{MM}$) Holes: $\pm .002"$ ($\pm 0,05\text{MM}$) Pads: $\pm .008"$ ($\pm 0,2\text{MM}$)

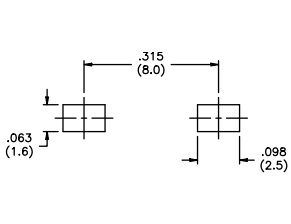

MJTP1106S

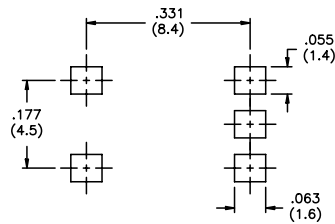

MJTP1122

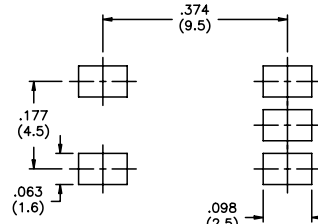

MJTP1122A

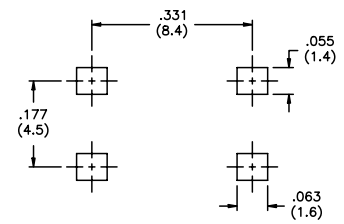

MJTP1122B

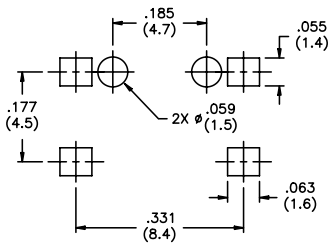

MJTP1137

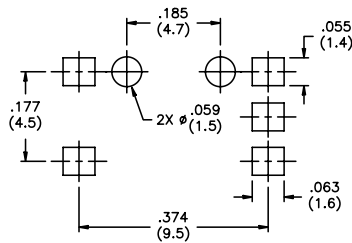

MJTP1137E

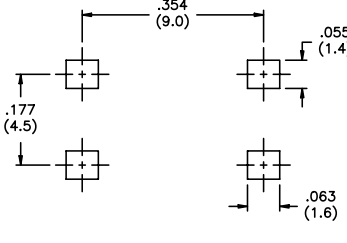

MJTP1138

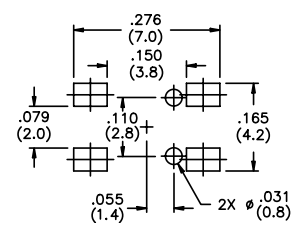

MJTP1140

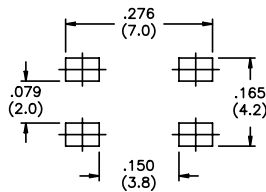

MJTP1140A

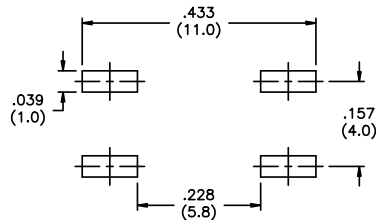

MJTP1162

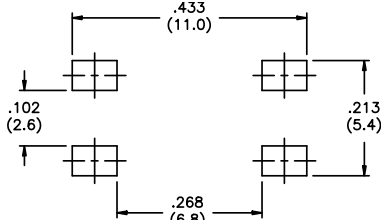

MJTPSMW

M

SPECIFICATIONS SUBJECT TO CHANGE WITHOUT NOTICE.

Данный компонент на территории Российской Федерации

Вы можете приобрести в компании MosChip.

Для оперативного оформления запроса Вам необходимо перейти по данной ссылке:

<http://moschip.ru/get-element>

Вы можете разместить у нас заказ для любого Вашего проекта, будь то серийное производство или разработка единичного прибора.

В нашем ассортименте представлены ведущие мировые производители активных и пассивных электронных компонентов.

Нашей специализацией является поставка электронной компонентной базы двойного назначения, продукции таких производителей как XILINX, Intel (ex.ALTERA), Vicor, Microchip, Texas Instruments, Analog Devices, Mini-Circuits, Amphenol, Glenair.

Сотрудничество с глобальными дистрибьюторами электронных компонентов, предоставляет возможность заказывать и получать с международных складов практически любой перечень компонентов в оптимальные для Вас сроки.

На всех этапах разработки и производства наши партнеры могут получить квалифицированную поддержку опытных инженеров.

Система менеджмента качества компании отвечает требованиям в соответствии с ГОСТ Р ИСО 9001, ГОСТ РВ 0015-002 и ЭС РД 009

Офис по работе с юридическими лицами:

105318, г.Москва, ул.Щербаковская д.3, офис 1107, 1118, ДЦ «Щербаковский»

Телефон: +7 495 668-12-70 (многоканальный)

Факс: +7 495 668-12-70 (доб.304)

E-mail: info@moschip.ru

Skype отдела продаж:

moschip.ru

moschip.ru_4

moschip.ru_6

moschip.ru_9