

### Description

Single and multipole magnetic circuit breakers with trip-free mechanism and toggle actuation. A choice of fast magnetic only or hydraulically delayed switching characteristics (S-type MO or HM CBE to EN 60934) ensures suitability for a wide range of applications. Industry standard dimensions and panel mounting. Options include auxiliary changeover contacts. Low temperature sensitivity at rated load.

Approved to CBE standard EN 60934 (IEC 60934).

### Typical application

Control equipment, communications systems, transportation, power supplies.

### Standard current ratings and typical internal resistance values

Current rating (A)	Internal resistance values (Ω) per pole			
	F1	F2	K1, M1, T1	K2, M2, T2
0,02	1 493	953	2 669	2 457
0,05	276	152	452	376
0,1	58	37	100	94
0,25	8,2	6,0	15,5	14,7
0,5	2,3	1,47	3,9	3,2
0,75	0,98	0,63	1,65	1,56
1	0,58	0,35	0,95	0,90
2	0,145	0,096	0,26	0,20
2,5	0,096	0,061	0,15	0,15
3	0,065	0,048	0,10	0,10
5	0,025	< 0,02	0,042	0,040
6	< 0,02	< 0,02	0,029	0,028
8	< 0,02	< 0,02	< 0,02	< 0,02
10	< 0,02	< 0,02	< 0,02	< 0,02
12	< 0,02	< 0,02	< 0,02	< 0,02
15	< 0,02	< 0,02	< 0,02	< 0,02
16	< 0,02	< 0,02	< 0,02	< 0,02
20	< 0,02	< 0,02	< 0,02	< 0,02
25	< 0,02	< 0,02	< 0,02	< 0,02
30	< 0,02	< 0,02	< 0,02	< 0,02
40	< 0,01	-	< 0,01	-
50	< 0,01	-	< 0,01	-



1-pole

8340-F...

2-pole

### Technical data

For further details please see chapter: Technical Information

Voltage rating	3 AC 415 V; AC 240 V, 50/60 Hz; DC 80 V (higher DC ratings to special order)		
Current ratings	0.02...50 A DC 0.02...30 A AC		
Auxiliary circuit	6 A, AC 240 V; 3 A, DC 28 V; 1 A, DC 65 V; 0.5 A, DC 80 V		
Typical life	3 AC 415 V, AC 240 V: 0.02...30 A 6,000 operations at 1 x I <sub>N</sub> , inductive 10,000 operations at 1 x I <sub>N</sub> , resistive DC 80 V: 0.02...25 A 6,000 operations at 1 x I <sub>N</sub> , inductive 0.02...30 A 10,000 operations at 1 x I <sub>N</sub> , resistive 40 + 50 A 6,000 operations at 1 x I <sub>N</sub> , resistive		
Ambient temperature	-40...+85 °C (-40...+185 °F)		
Insulation co-ordination (IEC 60664 and 60664A)	rated impulse withstand voltage 2.5 kV reinforced insulation in operating area	pollution degree 2	
Dielectric strength (IEC 60664 and 60664A)	operating area Line to Load pole to pole (2- and 3-pole) main to auxiliary circuit switching to trip circuit (version -X)	test voltage AC 3,000 V test voltage AC 1,500 V test voltage AC 1,500 V test voltage AC 3,000 V test voltage AC 1,500 V	
Insulation resistance	> 100 MΩ (DC 500 V)		
Interrupting capacity (IEC 60934 - test sequence E)	6 x IN at AC; 4 x IN at DC		
Interrupting capacity (UL 1077)	I <sub>N</sub>	0.02...20 A	25...30 A
	AC:	1-pole AC 250 V/3,500A 2-pole AC 250 V/3,500A 3-pole 3AC 250V/3,500A	AC 250 V/3,500A AC 250 V/5,000A 3AC250V/5,000A
	DC:	1-pole 0.02...50 A 2-pole 0.02...30 A	DC 80 V/3,500 A DC 80 V/3500 A
Degree of protection (IEC 60529/DIN 40050)	operating area IP40 terminal area IP00		
Vibration	with toggle down: 10 g (57-2000Hz) ± 0.76 mm (10-57 Hz) at 0.9 x IN directions 1, 2, 3, 4, 5: 10 g (57-2000 Hz) at 1 x IN.		
Shock	100 g (11 ms) at 1 x IN, directions 1,2,3,4,5 100 g (11 ms) at 0.8 x IN, direction 6.		
Corrosion	96 hours at 5 % salt mist, to IEC 60068-2-11, test Ka		
Humidity	240 hours at 95 % RH to IEC 60068-2-78, test Cab		
Mass	approx. 65 g per pole		

**Ordering information**

<b>Type No.</b>	8340 magnetic circuit breaker with toggle actuator
<b>Mounting</b>	F flange mounting
<b>Configuration</b>	1 with mounting nuts 6-32 UNC 4 with mounting nuts M3 9 snap-in frame
<b>Number of poles</b>	1 single pole protected 2 two pole protected 3 three pole protected
	} magnetic and hydraulic magnetic delayed
<b>Panel hardware</b>	0 without panel hardware
<b>Terminal design (main contact)</b>	K4 screw terminals M5 recommended for $I_N > 20$ A P1 blade terminals A6.3-0.8 mm (QC.250) ( $\leq 35$ A)
<b>Characteristic curve *)</b>	<b>Characteristic curve, instantaneous:</b> F1 DC F2 AC 50/60 Hz <b>Short delay:</b> K1 DC K2 AC 50/60 Hz <b>Medium delay:</b> M1 DC M2 AC 50/60 Hz <b>Long delay:</b> T1 DC T2 AC 50/60 Hz
<b>Actuator colour/design</b>	A black, long toggle K black, short toggle Z black, without toggle, with slot (only 1-pole)
<b>other colours to special order</b>	
<b>Marking on actuator</b>	0 without marking L I-O; ON-OFF N I-O; ON-OFF (IN on housing top)
<b>Auxiliary contacts</b>	H0 without auxiliary contacts H1 with auxiliary contacts, gold-flashed H2 auxiliary contacts, gold-flashed on one pole only (multipole)
<b>Auxiliary contact function</b>	4 1 change over contact
<b>Auxiliary contact terminal design</b>	2 blade terminal 2.8-0.5 mm
<b>Current ratings</b>	0.02...50 A
8340 - F 1 1 0 - P1 M1 - A L H1 4 2 - 30A ordering example	

**Approvals**

Authority	Standard	Rated voltage	Current ratings
VDE	IEC / EN 60934	AC 240/415 V AC 240 V DC 80 V	0.02 A...30 A 0.02 A...30 A 0.02 A...50 A
UL	UL 1077	AC 250 V DC 80 V DC 80 V	0.02 A...30 A 0.02 A...50 A 100 A (2 poles in parallel)
CSA	C22.2 No 235	AC 250 V DC 80 V	0.02 A...30 A 0.02 A...30 A
CQC	GB 17701	AC 240/415 V AC 240 V DC 80 V	0.02 A...30 A 0.02 A...30 A 0.02 A...50 A
QPL Sweden Defence Material Admin.	MIL-C-55629	AC 240 V DC 50 V AC 240 V AC 240 / 415 V	1 A...30 A (8340-F410) 1 A...30 A (8340-410) 1 A...30 A (8340-F420) 1 A...30 A (8340-F430)

**Internal connection diagrams**



\*) Other characteristic curves upon request (e.g. pulse delayed, for high inrush currents or capacitive loads)

**Preferred types**

Preferred types	Standard current ratings (A)													
	1	2	3	5	8	10	12	16	20	25	30	40	50	
8340-F410-P1K1-KNH0-	x	x	x	x	x	x	x	x	x					
8340-F410-P1K1-KNH142-	x	x	x	x	x	x	x	x	x					
8340-F410-P1M1-KNH0-	x	x	x	x	x	x	x	x	x					
8340-F410-P1M1-KNH142-	x	x	x	x	x	x	x	x	x					
8340-F410-K4K1-KNH0-										x	x	x	x	
8340-F410-K4K1-KNH142-										x	x	x	x	
8340-F410-K4M1-KNH0-										x	x	x	x	
8340-F410-K4M1-KNH142-										x	x	x	x	

**Dimensions**

**Flange mounting**

**Configuration: F4**

Actuator: long toggle

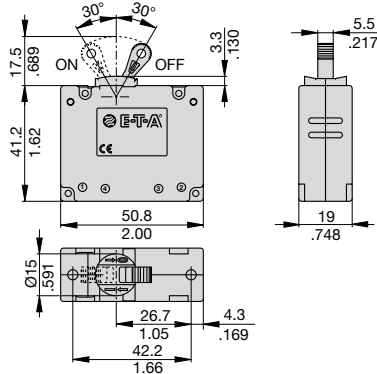

Actuator: short toggle

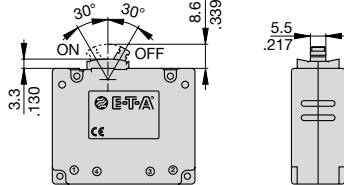

Actuator: without toggle, with slot

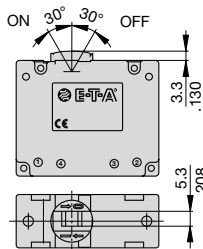

Applicable for nominal dimensions without direct tolerance indication: DIN ISO 286 ± IT13

number of poles: 1-3

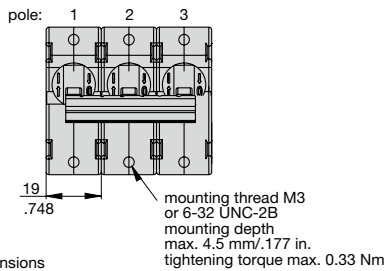

Cut-out dimensions max. panel thickness: 3 mm

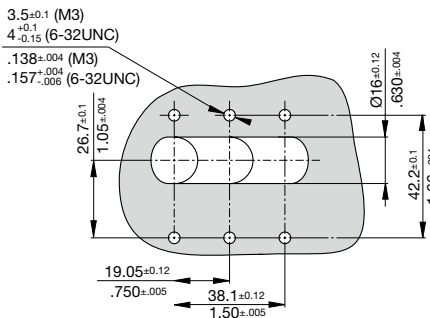

**Configuration: F9**

Actuator: long toggle

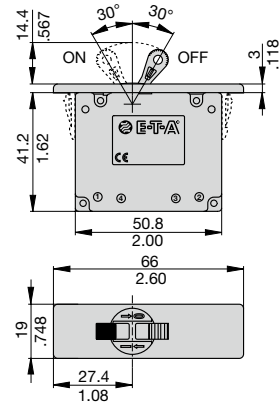

Actuator: short toggle

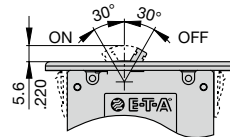

Actuator: without toggle, with slot

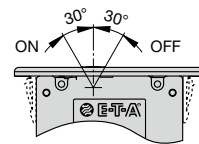

number of poles: 1-3

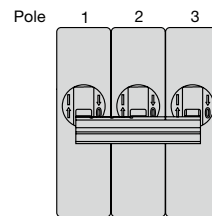

Cut-out dimensions max. panel thickness: 2 ± 0.1 mm or 4 ± 0.15 mm (snap-fit)

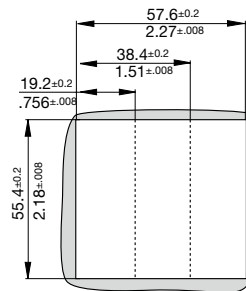

Applicable for nominal dimensions without direct tolerance indication: DIN ISO 286 ± IT13

This is a metric design and millimeter dimensions take precedence ( $\frac{\text{mm}}{\text{inch}}$ )



**Actuator configuration**

**Actuator design**

number of poles: 1 - 3  
Configuration: F4

**Actuator long**



**Actuator short**



number of poles: 1 - 3  
Configuration: F9

**Actuator long**

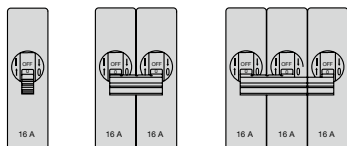

number of poles: 1  
Configuration: F4 / F9

**Actuator: Z (black, without toggle, with slot)**



**Terminal design / Dimensions**

**K4 screw terminals M5**  
tightening torque max. 1.2 Nm



**P1 blade terminals**

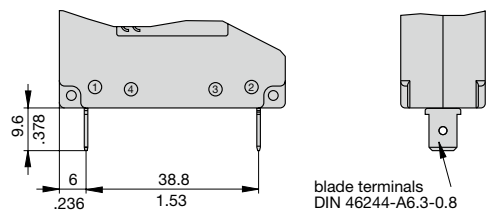

**Auxiliary contacts**

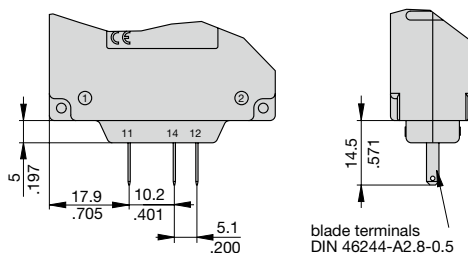

**Installation drawing**

**Terminal design K**

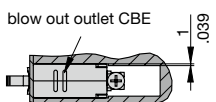

**Terminal design P**

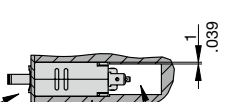

Trip time values indicated for front mounting on a vertical even surface

This is a metric design and millimeter dimensions take precedence ( $\frac{mm}{inch}$ )

**Shock directions / Mounting attitudes**



Typical time/current characteristics at 23 °C / +73.4 °F

**Curve F1 (instantaneous) for DC**



**Curve F2 (instantaneous) for AC**



**Curve K1 (short delay) for DC**



**Curve K2 (short delay) for AC 50/60 Hz**

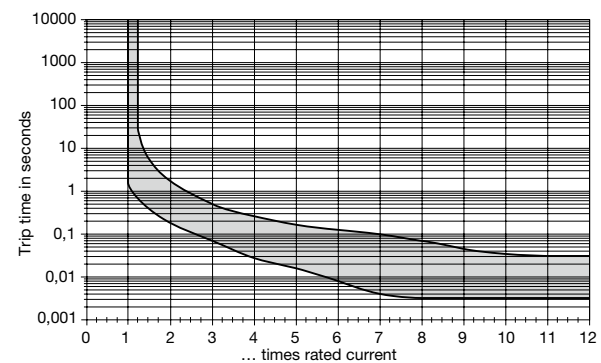

**Curve M1 (medium delay) for DC**



**Curve M2 (medium delay) for AC 50/60 Hz**

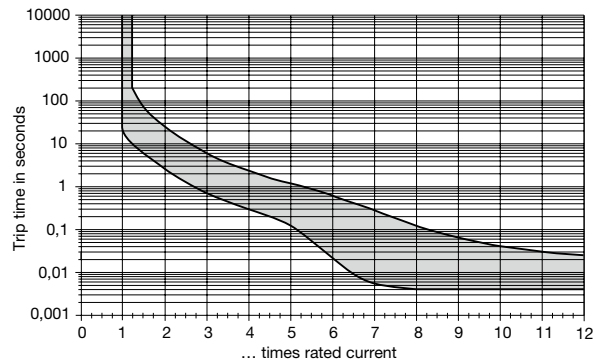

**Curve T1 (long delay) for DC**



**Curve T2 (long delay) for AC 50/60 Hz**

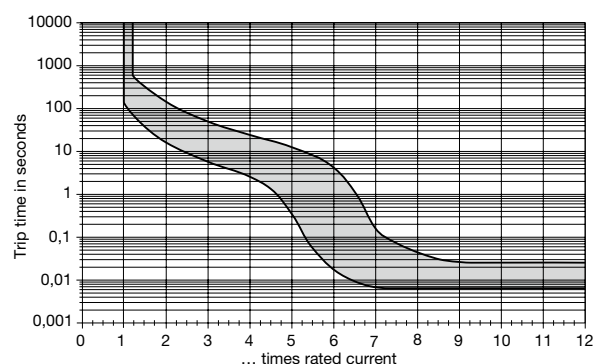

**N.B.** All curves will only be maintained if the escutcheon is mounted on a vertical surface. Ambient temperature or mounting side-by-side does not influence the trip curve, derating is not required. The breakers may trip in the event of current peaks < 0.003 sec. For these applications we offer a mechanical pulse delay – please enquire.

**Other characteristic curves upon request (e.g. pulse delayed, for high inrush currents or capacitive loads).**

1

**Accessories**

**Splash cover with mounting plate and screws  
for 8340-F1.. and 8340-F4**

**1 pole**

**Y 303 565 01**



**2 pole for 8340-F4**

**X 211 118 01**



**3 pole for 8340-F4**

**X 211 119 01**



**Toggle guard for 8340-F1.. and 8340-F4**

**Y 307 250 01**

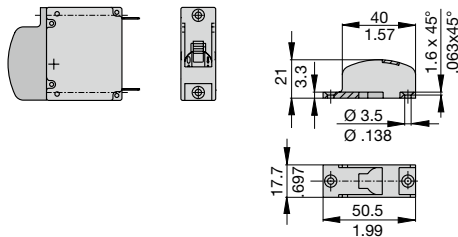

This is a metric design and millimeter dimensions take precedence ( $\frac{mm}{inch}$ )

All dimensions without tolerances are for reference only. In the interest of improved design, performance and cost effectiveness the right to make changes in these specifications without notice is reserved. Product markings may not be exactly as the ordering codes. Errors and omissions excepted.

## Данный компонент на территории Российской Федерации

### Вы можете приобрести в компании MosChip.

Для оперативного оформления запроса Вам необходимо перейти по данной ссылке:

<http://moschip.ru/get-element>

Вы можете разместить у нас заказ для любого Вашего проекта, будь то серийное производство или разработка единичного прибора.

В нашем ассортименте представлены ведущие мировые производители активных и пассивных электронных компонентов.

Нашей специализацией является поставка электронной компонентной базы двойного назначения, продукции таких производителей как XILINX, Intel (ex.ALTERA), Vicor, Microchip, Texas Instruments, Analog Devices, Mini-Circuits, Amphenol, Glenair.

Сотрудничество с глобальными дистрибьюторами электронных компонентов, предоставляет возможность заказывать и получать с международных складов практически любой перечень компонентов в оптимальные для Вас сроки.

На всех этапах разработки и производства наши партнеры могут получить квалифицированную поддержку опытных инженеров.

Система менеджмента качества компании отвечает требованиям в соответствии с ГОСТ Р ИСО 9001, ГОСТ РВ 0015-002 и ЭС РД 009

### Офис по работе с юридическими лицами:

105318, г.Москва, ул.Щербаковская д.3, офис 1107, 1118, ДЦ «Щербаковский»

Телефон: +7 495 668-12-70 (многоканальный)

Факс: +7 495 668-12-70 (доб.304)

E-mail: [info@moschip.ru](mailto:info@moschip.ru)

Skype отдела продаж:

moschip.ru

moschip.ru\_4

moschip.ru\_6

moschip.ru\_9