

TA Series



Power Chip Thick Film on Alumina Substrate

Ohmite's original Power Chip resistors feature our thick film on alumina substrate technology. These planar packages yield space saving, 10W/in² power densities that require over 50% less board space than other radial packages. Convection cooling is maximized by the planar package configuration which dissipates heat well above board level.

Ohmite's power chip resistors have a 125% higher operating temperature range than competitive product of similar design. High temperature solder and in-process plating keep terminations secure under self-heating effects by preventing re-flow from full power operation.

Flexible packaging schemes make these resistors ideal for power supplies, audio amplifiers, video fly-back, and other power control applications.



FEATURES

- High-Temp Terminal Construction
- Wide Resistance Range
- Low Inductance (50nH-100nH)
- High Power Density
- Easy to install. PC-mountable

SERIES SPECIFICATIONS

Series	Wattage	Series	Wattage	Series	Wattage	Series	Wattage	Series	Wattage
TA203	3.0	TA205	5.0	TA207	7.5	TA310	10.0	TA025	25.0
TA303	3.0	TA305	5.0	TA307	7.5	TA810	10.0	TA050	50.0
		TA605	5.0					TA100	100.0
		TA805	5.0						

CHARACTERISTICS

	Substrate	Alumina	Test Condition	
	Resistor	Thick Film	Test MILR83401	Specification
	Coating	Glass	Life (Rated Power)	40°C, rated power, 90 min ON 30 min OFF, 1000 hrs.
	Terminals	Solder Plated Phosphor Bronze	Life (Moisture Load)	60°C, 90 - 95% RH, rated power, 90 min ON 30 min OFF, 1000 hrs.
Temperature Coefficient	1 ohm:	450 ppm/°C	Temperature Cycling	Room temp > -55°C 30 min > RT 10 min ± 120°C 30 min > RT10 min 5 cycles
	1 to 100Ω:	100 ppm/°C	Flammability	UL94V-O rated (not recognized)
	101Ω and up:	50 ppm/°C	Soldering Heat	350°C Solderpot, 3 secs.
Tolerance	±1%, ±5% and ±10%		Insulation Resistance	DC 100V, 1 min
Power Rating	Based on 25°C free air			
Resistance Range	0.25 ohm to 10M ohm. Consult factory for other values			
Maximum Operating Voltage	350 VAC, 500 VDC through glass, 1000 VAC, 1500 VDC through substrate, not to exceed power rating			
Overload	Five times rated power, as long as the one second average dissipation does not exceed the wattage rating. ΔR: ±2%, 2000 hours			
Derating	100% @ 25°C to 0% @ 180°C ambient.			
Equivalent Parallel Capacitance	1.0pf (100 MHz)			
Withstanding Voltage	5000V thru back side			
Operating Temperature Range	-55°C to +180°C			
Overload Current	20 x rated current up to 8 ms (ΔR ± 0.5%)			

(continued)

rev 6/18-1

TA Series

Power Chip Thick Film on Alumina Substrate

DIMENSIONS

(±.020 in. / ±.508mm)

PA
3, 5, 7.5
& 10 watt



PW
10, 25, 50
& 100 watt

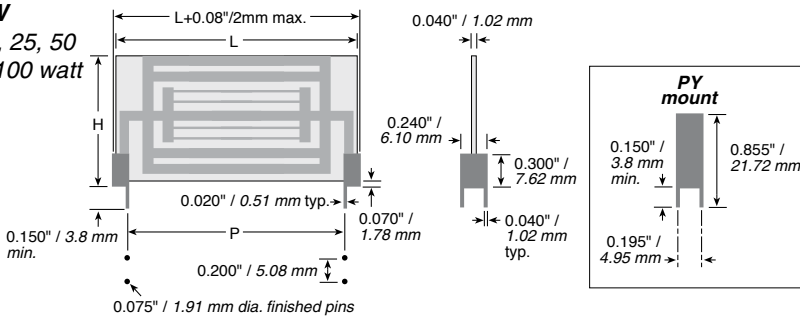

Series	Wattage	P	Length L	Height H
TA203PA	3.0	0.200 / 5.08	0.50 / 12.70	0.60 / 15.24
TA303PA	3.0	0.300 / 7.62	0.50 / 12.70	0.60 / 15.24
TA205PA	5.0	0.200 / 5.08	0.50 / 12.70	1.00 / 25.40
TA305PA	5.0	0.300 / 7.62	0.50 / 12.70	1.00 / 25.40
TA605PA	5.0	0.600 / 15.24	1.00 / 25.40	0.50 / 12.70
TA805PA	5.0	0.800 / 20.32	1.00 / 25.40	0.50 / 12.70
TA207PA	7.5	0.200 / 5.08	0.75 / 19.05	1.00 / 25.40
TA307PA	7.5	0.300 / 7.62	0.75 / 19.05	1.00 / 25.40
TA310PA	10.0	0.300 / 7.62	1.00 / 25.40	1.00 / 25.40
TA310PW*	10.0	0.300 / 7.62	1.085 / 27.56	1.00 / 25.40
TA810PA	10.0	0.800 / 20.32	1.00 / 25.40	1.00 / 25.40
TA810PW*	10.0	0.800 / 20.32	1.085 / 27.56	1.00 / 25.40
TA025PA	25.0	1.90 / 48.3	2.220 / 56.39	1.170 / 29.70
TA025PY*	25.0	1.90 / 48.3	2.220 / 56.39	1.170 / 29.70
TA050PA	50.0	1.90 / 48.3	2.220 / 56.39	2.270 / 57.60
TA050PY*	50.0	1.90 / 48.3	2.220 / 56.39	2.270 / 57.60
TA100PA	100.0	4.10 / 104.1	4.420 / 112.27	2.270 / 57.60
TA100PY*	100.0	4.10 / 104.1	4.420 / 112.27	2.270 / 57.60

*10-100 watts available in PW,PA, and PY packages.

ORDERING INFORMATION

Pin spacing (on 3-10W models only)
 2 = .2"
 3 = .3"
 8 = .8"

Tolerance
 K = 10%
 J = 5%
 F = 1%

RoHS compliant

TA 3 0 5 PA 4 K 5 0 J E

Series: TA
 Power Rating: 03 = 3 W, 05 = 5, 07 = 7.5, 10 = 10, 025 = 25, 050 = 50, 100 = 100
 Package: PA = pin terminals, std. for 3-10 W; PW = wraparound, std. for 10-100 W; PY = high-stability wraparound
 Resistance Value (Ω): R250 = 0.25, 10R0 = 10.0, 2K00 = 2,000, 45K0 = 45,000

Standard part numbers for TA series

Ohmic value	Part No. Prefix Suffix	Part Number	Ohmic value	Part No. Prefix Suffix	Part Number	Ohmic value	Part No. Prefix Suffix	Part Number
0.25	R250J	✓	50.00	50R0J	✓	2,500.00	2K50J	✓
1.00	1R00J	✓	62.00	62R0J	✓	3,000.00	3K00J	✓
1.50	1R50J	✓	68.00	68R0J	✓	4,000.00	4K00J	✓
2.00	2R00J	✓	75.00	75R0J	✓	4,700.00	4K70J	✓
4.70	4R70J	✓	100.00	100RJ	✓	5,000.00	5K00J	✓
5.00	5R00J	✓	150.00	150RJ	✓	5,100.00	5K10J	✓
5.10	5R10J	✓	200.00	200RJ	✓	7,500.00	7K50J	✓
7.50	7R50J	✓	250.00	250RJ	✓	10,000.00	10K0J	✓
8.20	8R20J	✓	270.00	270RJ	✓	15,000.00	15K0J	✓
10.00	10R0J	✓	300.00	300RJ	✓	18,000.00	18K0J	✓
11.00	11R0J	✓	470.00	470RJ	✓	20,000.00	20K0J	✓
12.00	12R0J	✓	500.00	560	✓	30,000.00	30K0J	✓
15.00	15R0J	✓	620.00	620RJ	✓	39,000.00	39K0J	✓
20.00	20R0J	✓	680.00	680RJ	✓	50,000.00	50K0J	✓
24.00	24R0J	✓	1,000.00	1K00J	✓	75,000.00	75K0J	✓
27.00	27R0J	✓	1,500.00	1K50J	✓	100,000	100KJ	✓
33.00	33R0J	✓	1,800.00	1K80J	✓	150,000	150KJ	✓
47.00	47R0J	✓	2,000.00	2K00J	✓	200,000	200KJ	✓

✓ = Stock values, + = Most popular standard values

Данный компонент на территории Российской Федерации

Вы можете приобрести в компании MosChip.

Для оперативного оформления запроса Вам необходимо перейти по данной ссылке:

<http://moschip.ru/get-element>

Вы можете разместить у нас заказ для любого Вашего проекта, будь то серийное производство или разработка единичного прибора.

В нашем ассортименте представлены ведущие мировые производители активных и пассивных электронных компонентов.

Нашей специализацией является поставка электронной компонентной базы двойного назначения, продукции таких производителей как XILINX, Intel (ex.ALTERA), Vicor, Microchip, Texas Instruments, Analog Devices, Mini-Circuits, Amphenol, Glenair.

Сотрудничество с глобальными дистрибьюторами электронных компонентов, предоставляет возможность заказывать и получать с международных складов практически любой перечень компонентов в оптимальные для Вас сроки.

На всех этапах разработки и производства наши партнеры могут получить квалифицированную поддержку опытных инженеров.

Система менеджмента качества компании отвечает требованиям в соответствии с ГОСТ Р ИСО 9001, ГОСТ РВ 0015-002 и ЭС РД 009

Офис по работе с юридическими лицами:

105318, г.Москва, ул.Щербаковская д.3, офис 1107, 1118, ДЦ «Щербаковский»

Телефон: +7 495 668-12-70 (многоканальный)

Факс: +7 495 668-12-70 (доб.304)

E-mail: info@moschip.ru

Skype отдела продаж:

moschip.ru

moschip.ru_4

moschip.ru_6

moschip.ru_9