ULTRA SMALL PACKAGE VOLTAGE REGULATOR

NO.EA-117-111018

OUTLINE

The R1100D Series are CMOS-based voltage regulator ICs with high accuracy output voltage and ultra-low supply current developed. Each of these ICs consists of a driver transistor, a voltage reference unit, an error amplifier, resistors for setting output voltage and a current limit circuit.

The output voltage of these ICs is fixed with high accuracy.

Even if V_{OUT} is shorted to the GND, the included current limit circuit protects the ICs from the destruction.

Since the package for these ICs is SON1408-3, high density mounting of the ICs on boards is possible.

FEATURES

- Supply current Typ. $0.8\mu\text{A}$ ($V_{OUT}=1.0\text{V}$, $V_{DD}=3.0\text{V}$)
- Dropout Voltage Typ. 20mV ($I_{OUT}=1\text{mA}$, $V_{OUT}=3.0\text{V}$)
- Output Voltage 0.9V to 4.0V (0.1V steps)
(For other voltages, please refer to MARK INFORMATION.)
- Output Voltage Accuracy $\pm 2.0\%$ ($1.2\text{V} \leq V_{OUT} \leq 4.0\text{V}$),
 $\pm 24\text{mV}$ ($V_{OUT} < 1.2\text{V}$)
- Temperature-Drift Coefficient of Output Voltage Typ. $\pm 100\text{ppm}/^\circ\text{C}$
- Line Regulation Typ. $0.05\%/V$
- Package SON1408-3
- Built-in Fold Back Protection Circuit Typ. 40mA (Current at short mode)
- Ceramic capacitors are recommended to be used with this IC $0.1\mu\text{F}$ or more

APPLICATIONS

- Power source for battery-powered equipment.
- Power source for cameras, VCRs, camcorders, hand-held audio instruments and hand-held communication equipment.
- Precision voltage references.

BLOCK DIAGRAM



SELECTION GUIDE

The output voltage for the ICs can be selected at the user's request.

| Product Name | Package | Quantity per Reel | Pb Free | Halogen Free |
|--|-----------|-------------------|---------|--------------|
| R1100Dxx1C-TR-F | SON1408-3 | 9,000 pcs | Yes | Yes |
| xx: The output voltage can be designated in the range from 0.9V(09) to 4.0V(40) in 0.1V steps. (For other voltages, please refer to MARK INFORMATIONS.) | | | | |

PIN CONFIGURATION

● SON1408-3



PIN DESCRIPTION

● SON1408-3

| Pin No | Symbol | Pin Description |
|--------|-----------|-----------------|
| 1 | V_{OUT} | Output pin |
| 2 | V_{DD} | Input Pin |
| 3 | GND | Ground Pin |

ABSOLUTE MAXIMUM RATINGS

(GND=0V)

| Symbol | Item | Rating | Unit |
|-----------|---------------------------------|------------------------------|------|
| V_{IN} | Input Voltage | 6.5 | V |
| V_{OUT} | Output Voltage | $V_{SS}-0.3$ to $V_{IN}+0.3$ | V |
| I_{OUT} | Output Current | 180 | mA |
| P_D | Power Dissipation * (SON1408-3) | 250 | mW |
| T_{opt} | Operating Temperature Range | -40 to 85 | °C |
| T_{stg} | Storage Temperature Range | -55 to~ 125 | °C |

*) For Power Dissipation, please refer to PACKAGE INFORMATION.

ABSOLUTE MAXIMUM RATINGS

Electronic and mechanical stress momentarily exceeded absolute maximum ratings may cause the permanent damages and may degrade the life time and safety for both device and system using the device in the field.

The functional operation at or over these absolute maximum ratings is not assured.

ELECTRICAL CHARACTERISTICS

• R1100D301C

 $T_{opt}=25^{\circ}\text{C}$

| Symbol | Item | Test Conditions | Min. | Typ. | Max. | Unit |
|---------------------------------|---|---|-------|-----------|-------|----------------------------|
| V_{OUT} | Output Voltage | $V_{IN}=5.0\text{V}$ $10\mu\text{A} \leq I_{OUT} \leq 10\text{mA}$ | 2.940 | 3.000 | 3.060 | V |
| I_{OUT} | Output Current | $V_{IN}=5.0\text{V}$ | 100 | | | mA |
| $\Delta V_{OUT}/\Delta I_{OUT}$ | Load Regulation | $V_{IN}=5.0\text{V}$, $1\text{mA} \leq I_{OUT} \leq 50\text{mA}$ | | 35 | 60 | mV |
| V_{DIF} | Dropout Voltage | $I_{OUT}=1\text{mA}$ | | 20 | 30 | mV |
| I_{SS} | Supply Current | $V_{IN}=5.0\text{V}$ | | 1.5 | 3.0 | μA |
| $\Delta V_{OUT}/\Delta V_{IN}$ | Line Regulation | $I_{OUT}=1\text{mA}$ Set $V_{OUT}+0.5\text{V} \leq V_{IN} \leq 6.0\text{V}$ | -0.20 | | 0.20 | %/V |
| V_{IN} | Input Voltage | | | | 6.0 | V |
| $\Delta V_{OUT}/\Delta T_{opt}$ | Output Voltage Temperature Coefficient | $I_{OUT}=10\text{mA}$ $-40^{\circ}\text{C} \leq T_{opt} \leq 85^{\circ}\text{C}$ | | ± 100 | | ppm/ $^{\circ}\text{C}$ |
| I_{SC} | Short Current Limit | $V_{OUT}=0\text{V}$ | | 40 | | mA |

ELECTRICAL CHARACTERISTICS BY OUTPUT VOLTAGE

Topt=25°C

| Part Number | Output Voltage | | | | Output Current | | | Load Regulation | | | Dropout Voltage | | | | | | | | |
|-------------|---|-------|-------|-------|---------------------------|------|------|--|------|------|-----------------|------|------|--|----|----|--|----|----|
| | Vout[V] | | | | Iout[mA] | | | $\Delta V_{OUT}/\Delta I_{OUT}$ [mV] | | | VdIF[mV] | | | | | | | | |
| | Condi- tions | MIN. | TYP. | MAX. | Condi- tions | MIN. | TYP. | Condi- tions | TYP. | MAX. | Condi- tions | TYP. | MAX. | | | | | | |
| R1100D091C | VIN- Set VOUT =2.0V 10μA ≤ IOUT ≤ 10mA | 0.876 | 0.900 | 0.924 | VIN- Set VOUT =2.0V | 35 | | VIN-Set VOUT =2.0V 1mA ≤ IOUT ≤ 20mA | 7.5 | 20 | | 380 | 750 | | | | | | |
| R1100D101C | | 0.976 | 1.000 | 1.024 | | | | | | | | 280 | 700 | | | | | | |
| R1100D111C | | 1.076 | 1.100 | 1.124 | | | | | | | | 200 | 600 | | | | | | |
| R1100D121C | | 1.176 | 1.200 | 1.224 | | | | | | | | 100 | 400 | | | | | | |
| R1100D131C | | 1.274 | 1.300 | 1.326 | | | | | | | | | | | | | | | |
| R1100D141C | | 1.372 | 1.400 | 1.428 | | | | | | | | 50 | 100 | | | | | | |
| R1100D151C | | 1.470 | 1.500 | 1.530 | | | | | | | | | | | | | | | |
| R1100D161C | | 1.568 | 1.600 | 1.632 | | | | | | | | 65 | | VIN-Set VOUT =2.0V 1mA ≤ IOUT ≤ 35mA | 20 | 40 | | 25 | 50 |
| R1100D171C | | 1.666 | 1.700 | 1.734 | | | | | | | | | | | | | | | |
| R1100D181C | | 1.764 | 1.800 | 1.836 | | | | | | | | | | | | | | | |
| R1100D191C | | 1.862 | 1.900 | 1.938 | | | | | | | | | | | | | | | |
| R1100D201C | | 1.960 | 2.000 | 2.040 | | | | | | | | | | | | | | | |
| R1100D211C | | 2.058 | 2.100 | 2.142 | | | | | | | | | | | | | | | |
| R1100D221C | | 2.156 | 2.200 | 2.244 | | | | | | | | | | | | | | | |
| R1100D231C | | 2.254 | 2.300 | 2.346 | | | | | | | | | | | | | | | |
| R1100D241C | | 2.352 | 2.400 | 2.448 | | | | | | | | | | | | | | | |
| R1100D251C | | 2.450 | 2.500 | 2.550 | | | | | | | | | | | | | | | |
| R1100D261C | | 2.548 | 2.600 | 2.652 | | 100 | | VIN-Set VOUT =2.0V 1mA ≤ IOUT ≤ 50mA | 35 | 60 | | 20 | 30 | | | | | | |
| R1100D271C | | 2.646 | 2.700 | 2.754 | | | | | | | | | | | | | | | |
| R1100D281C | | 2.744 | 2.800 | 2.856 | | | | | | | | | | | | | | | |
| R1100D291C | 2.842 | 2.900 | 2.958 | | | | | | | | | | | | | | | | |
| R1100D301C | 2.940 | 3.000 | 3.060 | | | | | | | | | | | | | | | | |
| R1100D311C | 3.038 | 3.100 | 3.162 | | | | | | | | | | | | | | | | |
| R1100D321C | 3.136 | 3.200 | 3.264 | | | | | | | | | | | | | | | | |
| R1100D331C | 3.234 | 3.300 | 3.366 | | | | | | | | | | | | | | | | |
| R1100D341C | 3.332 | 3.400 | 3.468 | | | | | | | | | | | | | | | | |
| R1100D351C | 3.430 | 3.500 | 2.570 | | | | | | | | | | | | | | | | |
| R1100D361C | 3.528 | 3.600 | 3.672 | | | | | | | | | | | | | | | | |
| R1100D371C | 3.626 | 3.700 | 3.774 | | | | | | | | | | | | | | | | |
| R1100D381C | 3.724 | 3.800 | 3.876 | | | | | | | | | | | | | | | | |
| R1100D391C | 3.822 | 3.900 | 3.978 | | | | | | | | | | | | | | | | |
| R1100D401C | 3.920 | 4.000 | 4.080 | | | | | | | | | | | | | | | | |

ELECTRICAL CHARACTERISTICS

(Common characteristics)

| Symbol | Item | Test Conditions | Min. | Typ. | Max. | Unit |
|---------------------------------|---|---|-------|-----------|------|------------|
| $\Delta V_{OUT}/\Delta V_{IN}$ | Line Regulation | $I_{OUT}=1\text{mA}$ Set $V_{OUT}+0.5\text{V} \leq V_{IN} \leq 6\text{V}$ | -0.20 | | 0.20 | %/V |
| V_{IN} | Input Voltage | | (1.2) | | 6.0 | V |
| $\Delta V_{OUT}/\Delta T_{opt}$ | Output Voltage Temperature Coefficient | $I_{OUT}=10\text{mA}$ $-40^{\circ}\text{C} \leq T_{opt} \leq 85^{\circ}\text{C}$ | | ± 100 | | ppm/ °C |
| I_{SC} | Short Current Limit | $V_{OUT}=0\text{V}$ | | 40 | | mA |

ELECTRICAL CHARACTERISTICS BY OUTPUT VOLTAGE

| Symbol | Item | Output Voltage | Conditions | Min. | Typ. | Max. | Unit |
|----------|----------------|---|--|------|------|------|---------------|
| I_{SS} | Supply Current | $0.9\text{V} \leq V_{OUT} \leq 1.0\text{V}$ | $V_{IN}=\text{Set } V_{OUT}+2.0\text{V}$ | | 0.8 | 1.8 | μA |
| | | $1.1\text{V} \leq V_{OUT} \leq 1.4\text{V}$ | | | 1.0 | 2.4 | |
| | | $1.5\text{V} \leq V_{OUT} \leq 2.0\text{V}$ | | | 1.2 | 2.7 | |
| | | $2.1\text{V} \leq V_{OUT} \leq 4.0\text{V}$ | | | 1.5 | 3.0 | |

RECOMMENDED OPERATING CONDITIONS (ELECTRICAL CHARACTERISTICS)

All of electronic equipment should be designed that the mounted semiconductor devices operate within the recommended operating conditions. The semiconductor devices cannot operate normally over the recommended operating conditions, even if when they are used over such conditions by momentary electronic noise or surge. And the semiconductor devices may receive serious damage when they continue to operate over the recommended operating conditions.

OPERATION

These ICs, the output voltage V_{OUT} is detected by Feedback Resistors, and the detected output voltage is compared with a reference voltage by the error amplifier, so that a constant voltage is output.

A current limit circuit against short protection and a chip enable circuit are included.

TEST CIRCUITS

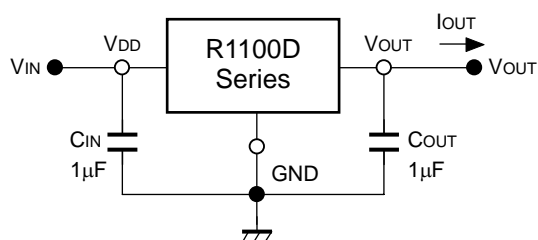

Standard Test Circuit

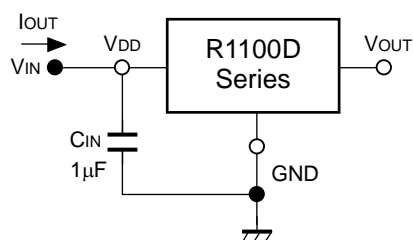

Test Circuit for Supply Current

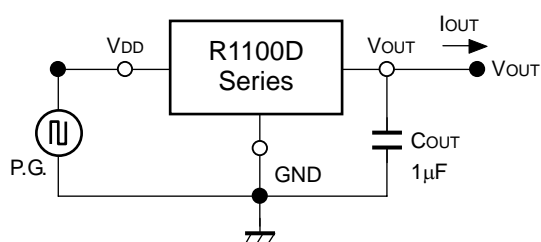

Test Circuit for Line Transient Response

TECHNICAL NOTES

In R1100D Series, a constant voltage can be obtained without using capacitors. However, when the wire connected V_{IN} is long, use a capacitor. Output noise can be reduced with using capacitor.

Insert capacitors with the capacitance of $0.1\mu\text{F}$ to $2.2\mu\text{F}$ between input/output pins and GND pin as close as possible.

TYPICAL CHARACTERISTICS

1) Output Voltage vs. Output Current



2) Output Voltage vs. Input Voltage

R1100D091C



R1100D091C



R1100D301C

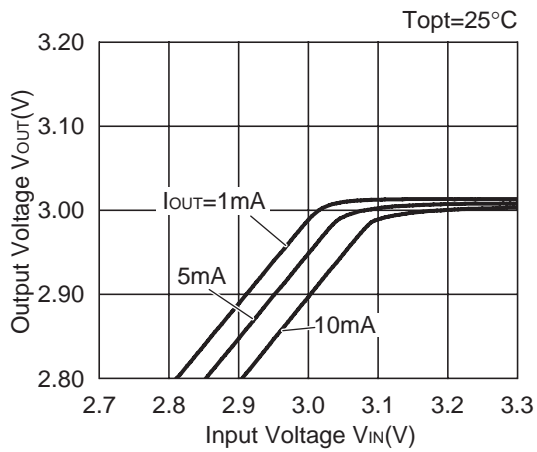

R1100D301C

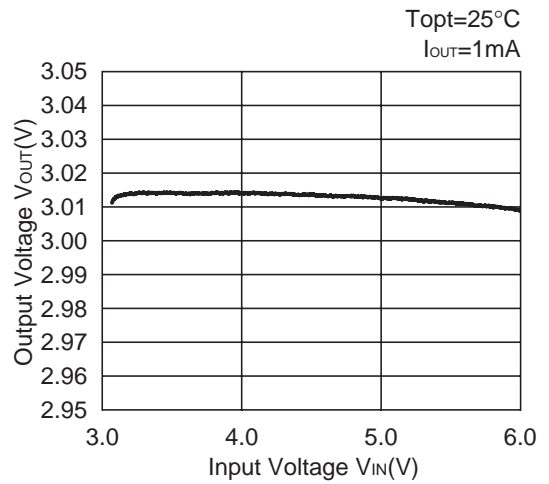

R1100D401C

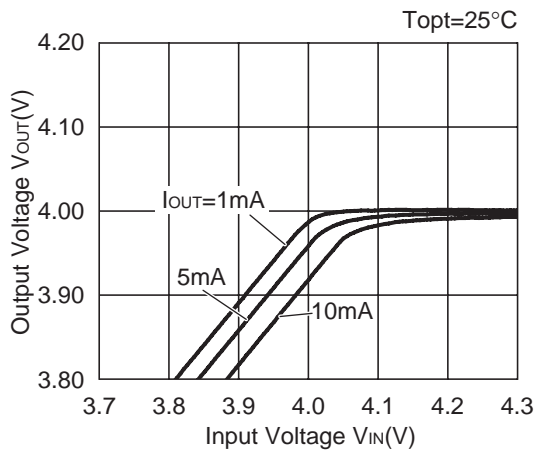

R1100D401C

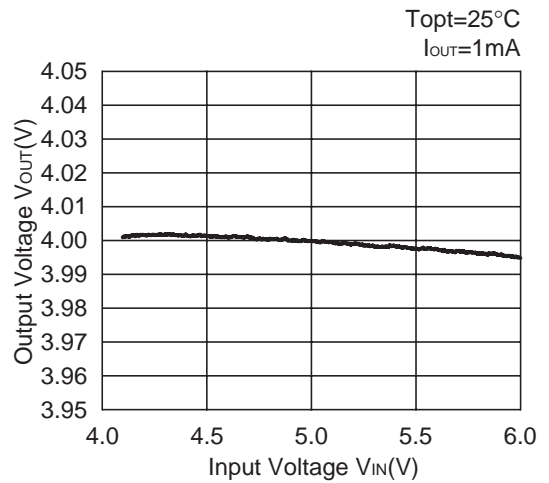

3) Dropout Voltage vs. Output Current

R1100D091C

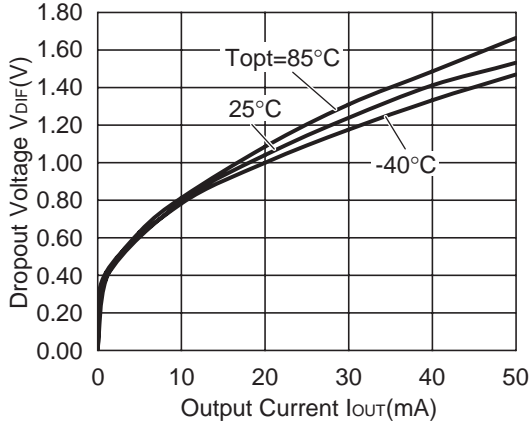

R1100D301C

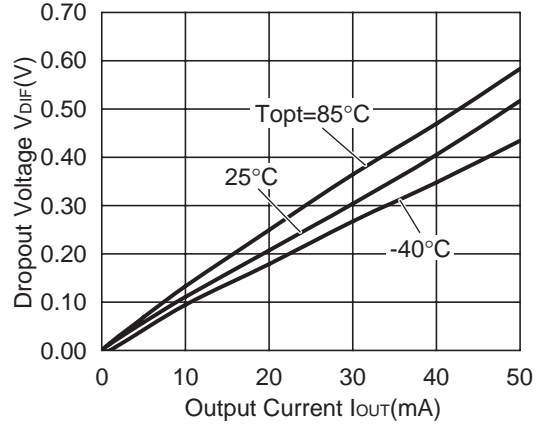

R1100D401C

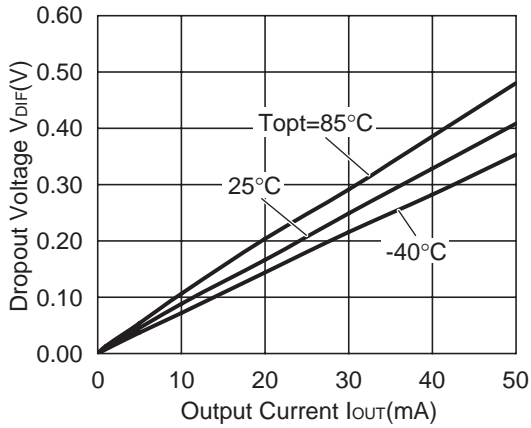

4) Output Voltage vs. Temperature

R1100D091C

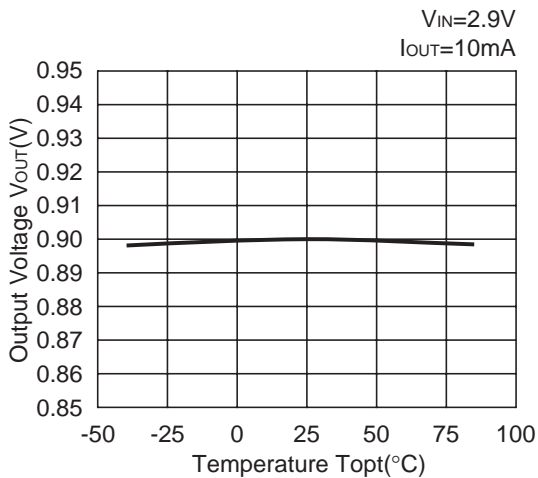

R1100D301C

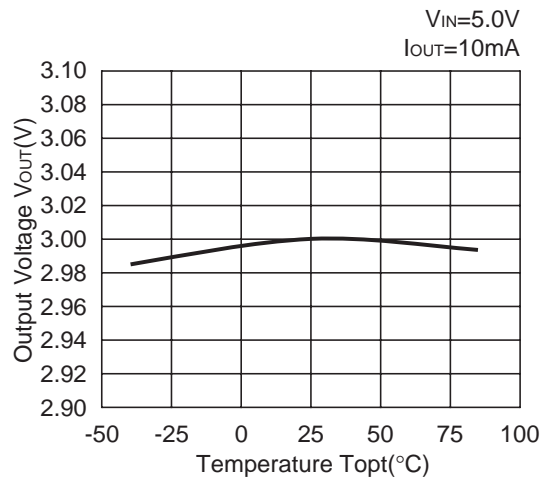

R1100D401C



5) Supply Current vs. Input Voltage

R1100D091C



R1100D301C

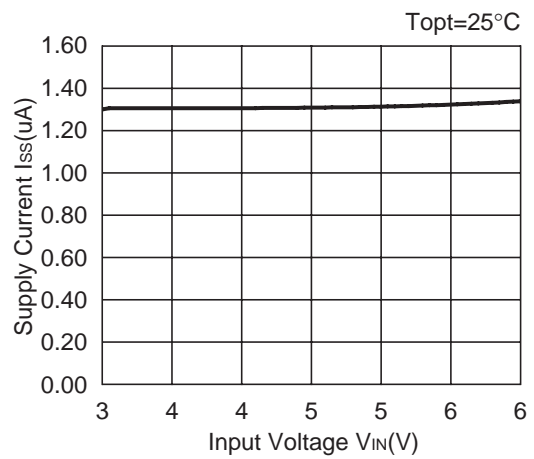

R1100D401C

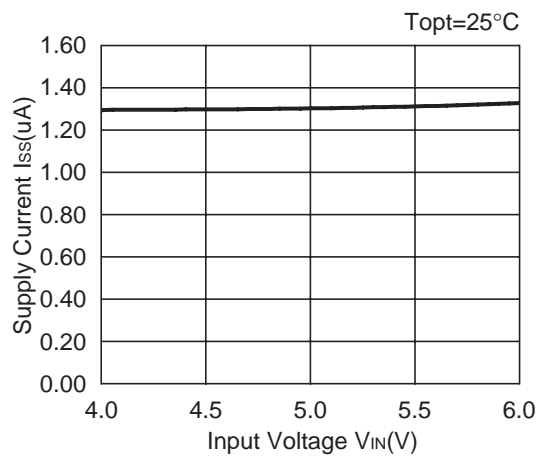

6) Supply Current vs. Temperature

R1100D091C



R1100D301C

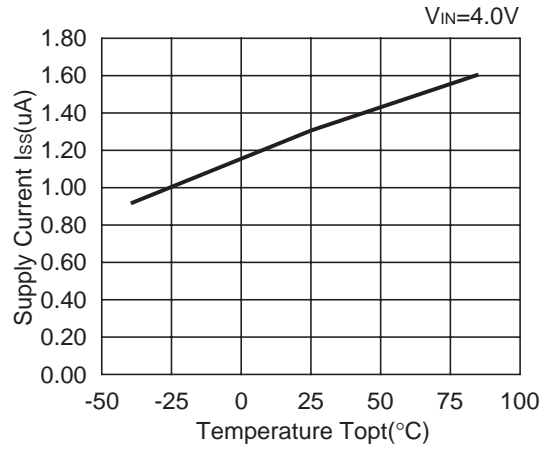

R1100D401C



7) Dropout Voltage vs. Set Output Voltage

R1100Dxx1C

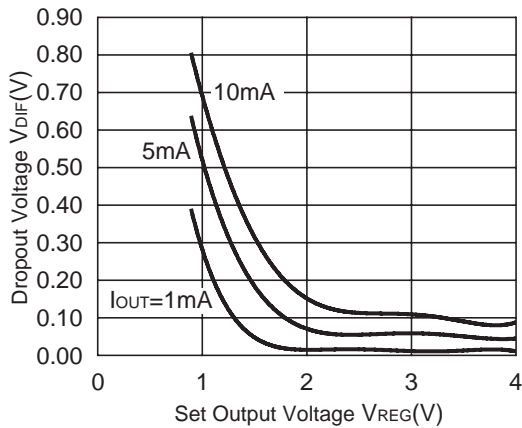

8) Line Transient Response

R1100D091C

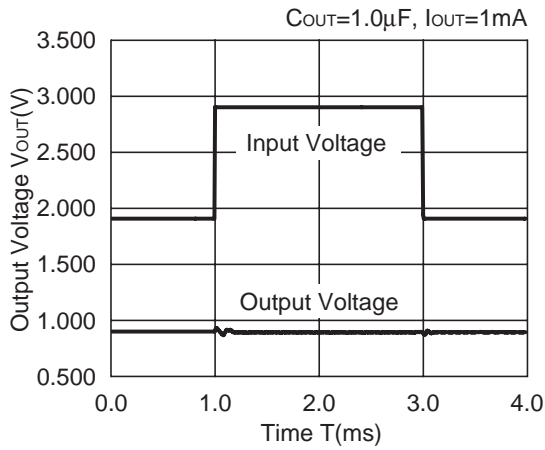

R1100D091C

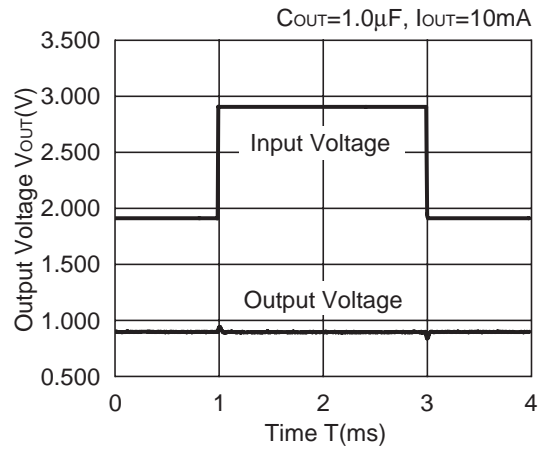

R1100D301C

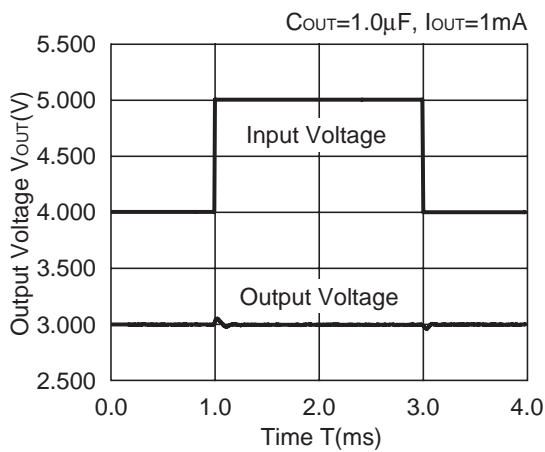

R1100D301C

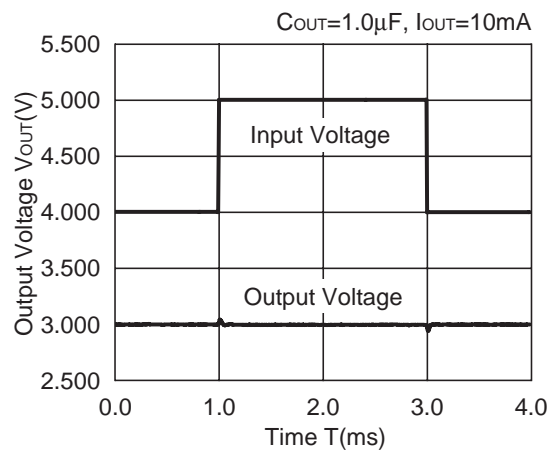

R1100D401C

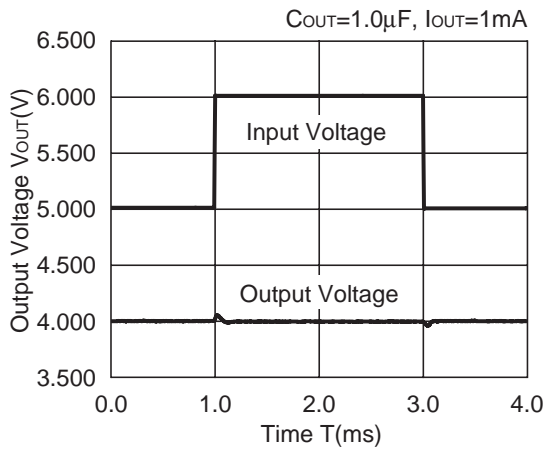

R1100D401C

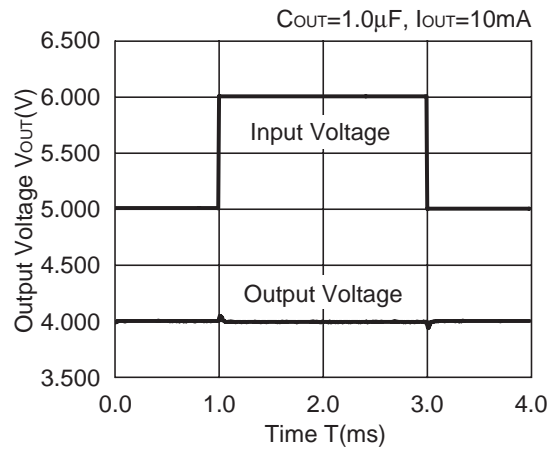

9) Load Transient Response

R1100D091C



R1100D301C

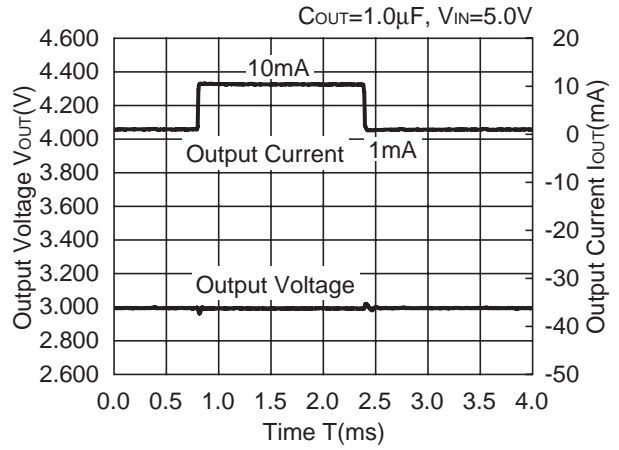

R1100D401C

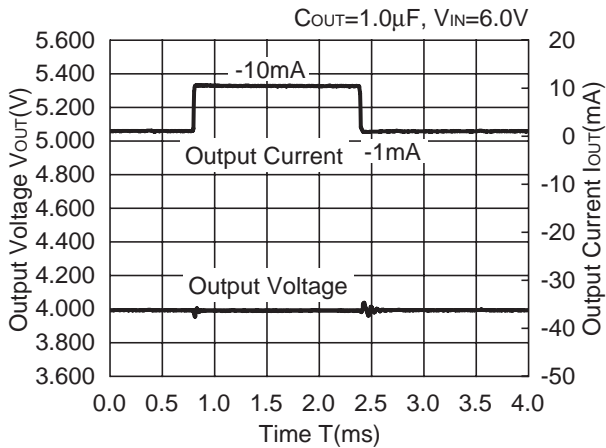

10) Ripple Rejection vs. Frequency

R1100D091C

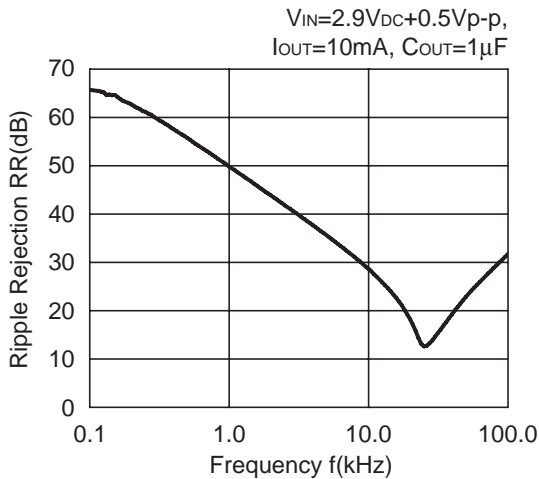

R1100D301C

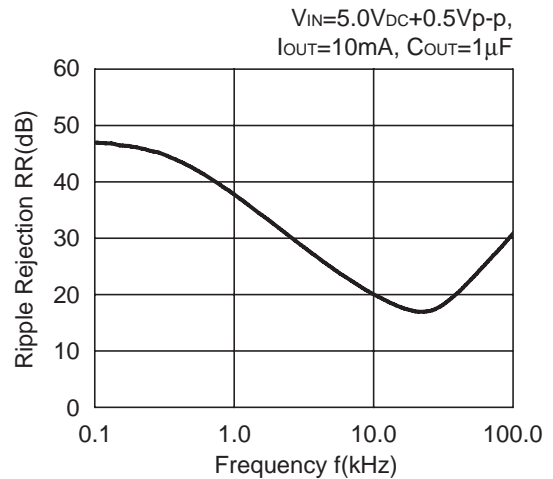

R1100D401C

$V_{IN}=5.5V_{DC}+0.5V_{p-p}$,
 $I_{OUT}=10mA$, $C_{OUT}=1\mu F$

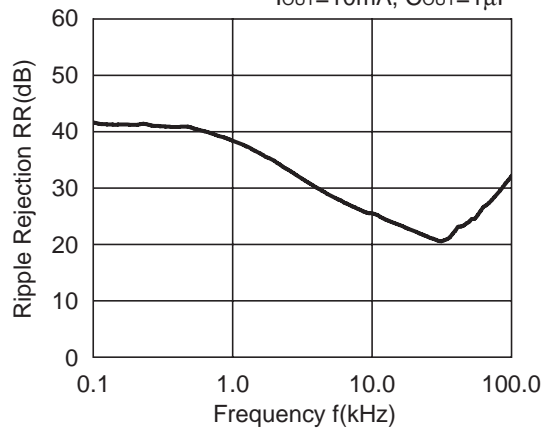



1. The products and the product specifications described in this document are subject to change or discontinuation of production without notice for reasons such as improvement. Therefore, before deciding to use the products, please refer to Ricoh sales representatives for the latest information thereon.
2. The materials in this document may not be copied or otherwise reproduced in whole or in part without prior written consent of Ricoh.
3. Please be sure to take any necessary formalities under relevant laws or regulations before exporting or otherwise taking out of your country the products or the technical information described herein.
4. The technical information described in this document shows typical characteristics of and example application circuits for the products. The release of such information is not to be construed as a warranty of or a grant of license under Ricoh's or any third party's intellectual property rights or any other rights.
5. The products listed in this document are intended and designed for use as general electronic components in standard applications (office equipment, telecommunication equipment, measuring instruments, consumer electronic products, amusement equipment etc.). Those customers intending to use a product in an application requiring extreme quality and reliability, for example, in a highly specific application where the failure or misoperation of the product could result in human injury or death (aircraft, spacevehicle, nuclear reactor control system, traffic control system, automotive and transportation equipment, combustion equipment, safety devices, life support system etc.) should first contact us.
6. We are making our continuous effort to improve the quality and reliability of our products, but semiconductor products are likely to fail with certain probability. In order to prevent any injury to persons or damages to property resulting from such failure, customers should be careful enough to incorporate safety measures in their design, such as redundancy feature, fire containment feature and fail-safe feature. We do not assume any liability or responsibility for any loss or damage arising from misuse or inappropriate use of the products.
7. Anti-radiation design is not implemented in the products described in this document.
8. Please contact Ricoh sales representatives should you have any questions or comments concerning the products or the technical information.



Ricoh is committed to reducing the environmental loading materials in electrical devices with a view to contributing to the protection of human health and the environment.

Ricoh has been providing RoHS compliant products since April 1, 2006 and Halogen-free products since April 1, 2012.

RICOH RICOH ELECTRONIC DEVICES CO., LTD.

<http://www.e-devices.ricoh.co.jp/en/>

Sales & Support Offices

RICOH ELECTRONIC DEVICES CO., LTD.

Higashi-Shinagawa Office (International Sales)
3-32-3, Higashi-Shinagawa, Shinagawa-ku, Tokyo 140-8655, Japan
Phone: +81-3-5479-2857 Fax: +81-3-5479-0502

RICOH EUROPE (NETHERLANDS) B.V.

Semiconductor Support Centre
Prof. W.H. Keesomlaan 1, 1183 DJ Amstelveen, The Netherlands
Phone: +31-20-5474-309

RICOH ELECTRONIC DEVICES KOREA CO., LTD.

3F, Haesung Bldg. 504, Teheran-ro, Gangnam-gu, Seoul, 135-725, Korea
Phone: +82-2-2135-5700 Fax: +82-2-2051-5713

RICOH ELECTRONIC DEVICES SHANGHAI CO., LTD.

Room 403, No.2 Building, No.690 Bilbo Road, Pu Dong New District, Shanghai 201203,
People's Republic of China
Phone: +86-21-5027-3200 Fax: +86-21-5027-3299

RICOH ELECTRONIC DEVICES CO., LTD.

Taipei office
Room 109, 10F-1, No.51, Hengyang Rd., Taipei City, Taiwan (R.O.C.)
Phone: +886-2-2313-1621/1622 Fax: +886-2-2313-1623

Mouser Electronics

Authorized Distributor

Click to View Pricing, Inventory, Delivery & Lifecycle Information:

Ricoh Electronics:

[R1100D331C-TR-F](#) [R1100D101C-TR-F](#) [R1100D201C-TR-F](#) [R1100D301C-TR-F](#) [R1100D181C-TR-F](#) [R1100D121C-TR-F](#) [R1100D381C-TR-F](#) [R1100D221C-TR-F](#)

Данный компонент на территории Российской Федерации

Вы можете приобрести в компании MosChip.

Для оперативного оформления запроса Вам необходимо перейти по данной ссылке:

<http://moschip.ru/get-element>

Вы можете разместить у нас заказ для любого Вашего проекта, будь то серийное производство или разработка единичного прибора.

В нашем ассортименте представлены ведущие мировые производители активных и пассивных электронных компонентов.

Нашей специализацией является поставка электронной компонентной базы двойного назначения, продукции таких производителей как XILINX, Intel (ex.ALTERA), Vicor, Microchip, Texas Instruments, Analog Devices, Mini-Circuits, Amphenol, Glenair.

Сотрудничество с глобальными дистрибьюторами электронных компонентов, предоставляет возможность заказывать и получать с международных складов практически любой перечень компонентов в оптимальные для Вас сроки.

На всех этапах разработки и производства наши партнеры могут получить квалифицированную поддержку опытных инженеров.

Система менеджмента качества компании отвечает требованиям в соответствии с ГОСТ Р ИСО 9001, ГОСТ РВ 0015-002 и ЭС РД 009

Офис по работе с юридическими лицами:

105318, г.Москва, ул.Щербаковская д.3, офис 1107, 1118, ДЦ «Щербаковский»

Телефон: +7 495 668-12-70 (многоканальный)

Факс: +7 495 668-12-70 (доб.304)

E-mail: info@moschip.ru

Skype отдела продаж:

moschip.ru

moschip.ru_4

moschip.ru_6

moschip.ru_9