

---

## ULTRA SMALL PACKAGE VOLTAGE REGULATOR

---

NO.EA-117-111018

### OUTLINE

The R1100D Series are CMOS-based voltage regulator ICs with high accuracy output voltage and ultra-low supply current developed. Each of these ICs consists of a driver transistor, a voltage reference unit, an error amplifier, resistors for setting output voltage and a current limit circuit.

The output voltage of these ICs is fixed with high accuracy.

Even if  $V_{OUT}$  is shorted to the GND, the included current limit circuit protects the ICs from the destruction.

Since the package for these ICs is SON1408-3, high density mounting of the ICs on boards is possible.

### FEATURES

- Supply current ..... Typ.  $0.8\mu\text{A}$  ( $V_{OUT}=1.0\text{V}$ ,  $V_{DD}=3.0\text{V}$ )
- Dropout Voltage ..... Typ.  $20\text{mV}$  ( $I_{OUT}=1\text{mA}$ ,  $V_{OUT}=3.0\text{V}$ )
- Output Voltage .....  $0.9\text{V}$  to  $4.0\text{V}$  ( $0.1\text{V}$  steps)  
(For other voltages, please refer to MARK INFORMATION.)
- Output Voltage Accuracy .....  $\pm 2.0\%$  ( $1.2\text{V} \leq V_{OUT} \leq 4.0\text{V}$ ),  
 $\pm 24\text{mV}$  ( $V_{OUT} < 1.2\text{V}$ )
- Temperature-Drift Coefficient of Output Voltage ..... Typ.  $\pm 100\text{ppm}/^\circ\text{C}$
- Line Regulation ..... Typ.  $0.05\%/V$
- Package ..... SON1408-3
- Built-in Fold Back Protection Circuit ..... Typ.  $40\text{mA}$  (Current at short mode)
- Ceramic capacitors are recommended to be used with this IC .....  $0.1\mu\text{F}$  or more

### APPLICATIONS

- Power source for battery-powered equipment.
- Power source for cameras, VCRs, camcorders, hand-held audio instruments and hand-held communication equipment.
- Precision voltage references.

## BLOCK DIAGRAM



## SELECTION GUIDE

The output voltage for the ICs can be selected at the user's request.

Product Name	Package	Quantity per Reel	Pb Free	Halogen Free
R1100Dxx1C-TR-F	SON1408-3	9,000 pcs	Yes	Yes
xx: The output voltage can be designated in the range from 0.9V(09) to 4.0V(40) in 0.1V steps. (For other voltages, please refer to MARK INFORMATIONS.)				

## PIN CONFIGURATION

### ● SON1408-3



## PIN DESCRIPTION

### ● SON1408-3

Pin No	Symbol	Pin Description
1	$V_{OUT}$	Output pin
2	$V_{DD}$	Input Pin
3	GND	Ground Pin

## ABSOLUTE MAXIMUM RATINGS

(GND=0V)

Symbol	Item	Rating	Unit
$V_{IN}$	Input Voltage	6.5	V
$V_{OUT}$	Output Voltage	$V_{SS}-0.3$ to $V_{IN}+0.3$	V
$I_{OUT}$	Output Current	180	mA
$P_D$	Power Dissipation * (SON1408-3)	250	mW
$T_{opt}$	Operating Temperature Range	-40 to 85	°C
$T_{stg}$	Storage Temperature Range	-55 to~ 125	°C

\*) For Power Dissipation, please refer to PACKAGE INFORMATION.

### ABSOLUTE MAXIMUM RATINGS

Electronic and mechanical stress momentarily exceeded absolute maximum ratings may cause the permanent damages and may degrade the life time and safety for both device and system using the device in the field.

The functional operation at or over these absolute maximum ratings is not assured.

## ELECTRICAL CHARACTERISTICS

## • R1100D301C

T<sub>opt</sub>=25°C

Symbol	Item	Test Conditions	Min.	Typ.	Max.	Unit
V <sub>OUT</sub>	Output Voltage	V <sub>IN</sub> =5.0V 10μA ≤ I <sub>OUT</sub> ≤ 10mA	2.940	3.000	3.060	V
I <sub>OUT</sub>	Output Current	V <sub>IN</sub> =5.0V	100			mA
ΔV <sub>OUT</sub> /ΔI <sub>OUT</sub>	Load Regulation	V <sub>IN</sub> =5.0V, 1mA ≤ I <sub>OUT</sub> ≤ 50mA		35	60	mV
V <sub>DIF</sub>	Dropout Voltage	I <sub>OUT</sub> =1mA		20	30	mV
I <sub>SS</sub>	Supply Current	V <sub>IN</sub> =5.0V		1.5	3.0	μA
ΔV <sub>OUT</sub> /ΔV <sub>IN</sub>	Line Regulation	I <sub>OUT</sub> =1mA Set V <sub>OUT</sub> +0.5V ≤ V <sub>IN</sub> ≤ 6.0V	-0.20		0.20	%/V
V <sub>IN</sub>	Input Voltage				6.0	V
ΔV <sub>OUT</sub> /ΔT <sub>opt</sub>	Output Voltage Temperature Coefficient	I <sub>OUT</sub> =10mA -40°C ≤ T <sub>opt</sub> ≤ 85°C		±100		ppm/ °C
I <sub>SC</sub>	Short Current Limit	V <sub>OUT</sub> =0V		40		mA

## ELECTRICAL CHARACTERISTICS BY OUTPUT VOLTAGE

Topt=25°C

Part Number	Output Voltage				Output Current			Load Regulation			Dropout Voltage			
	Vout[V]				Iout[mA]			ΔVOUT/ΔIOUT[mV]			VdIF[mV]			
	Condi- tions	MIN.	TYP.	MAX.	Condi- tions	MIN.	TYP.	Condi- tions	TYP.	MAX.	Condi- tions	TYP.	MAX.	
R1100D091C	VIN- Set VOUT =2.0V  10μA ≤ IOUT ≤ 10mA	0.876	0.900	0.924	VIN- Set VOUT =2.0V	35		VIN-Set VOUT =2.0V  1mA ≤ IOUT ≤ 20mA	7.5	20				
R1100D101C		0.976	1.000	1.024										
R1100D111C		1.076	1.100	1.124										
R1100D121C		1.176	1.200	1.224										
R1100D131C		1.274	1.300	1.326										
R1100D141C		1.372	1.400	1.428										
R1100D151C		1.470	1.500	1.530										
R1100D161C		1.568	1.600	1.632										
R1100D171C		1.666	1.700	1.734										
R1100D181C		1.764	1.800	1.836										
R1100D191C		1.862	1.900	1.938										
R1100D201C		1.960	2.000	2.040										
R1100D211C		2.058	2.100	2.142										
R1100D221C		2.156	2.200	2.244		65		VIN-Set VOUT =2.0V  1mA ≤ IOUT ≤ 35mA	20	40		IOUT =1mA		
R1100D231C		2.254	2.300	2.346										
R1100D241C		2.352	2.400	2.448										
R1100D251C		2.450	2.500	2.550										
R1100D261C		2.548	2.600	2.652										
R1100D271C		2.646	2.700	2.754										
R1100D281C		2.744	2.800	2.856										
R1100D291C	2.842	2.900	2.958											
R1100D301C	2.940	3.000	3.060											
R1100D311C	3.038	3.100	3.162											
R1100D321C	3.136	3.200	3.264	100		VIN-Set VOUT =2.0V  1mA ≤ IOUT ≤ 50mA	35	60		IOUT =1mA				
R1100D331C	3.234	3.300	3.366											
R1100D341C	3.332	3.400	3.468											
R1100D351C	3.430	3.500	2.570											
R1100D361C	3.528	3.600	3.672											
R1100D371C	3.626	3.700	3.774											
R1100D381C	3.724	3.800	3.876											
R1100D391C	3.822	3.900	3.978											
R1100D401C	3.920	4.000	4.080											

## ELECTRICAL CHARACTERISTICS

(Common characteristics)

Symbol	Item	Test Conditions	Min.	Typ.	Max.	Unit
$\Delta V_{OUT}/\Delta V_{IN}$	Line Regulation	$I_{OUT}=1\text{mA}$ Set $V_{OUT}+0.5\text{V} \leq V_{IN} \leq 6\text{V}$	-0.20		0.20	%/V
$V_{IN}$	Input Voltage		(1.2)		6.0	V
$\Delta V_{OUT}/\Delta T_{opt}$	Output Voltage Temperature Coefficient	$I_{OUT}=10\text{mA}$ $-40^{\circ}\text{C} \leq T_{opt} \leq 85^{\circ}\text{C}$		$\pm 100$		ppm/ °C
$I_{SC}$	Short Current Limit	$V_{OUT}=0\text{V}$		40		mA

## ELECTRICAL CHARACTERISTICS BY OUTPUT VOLTAGE

Symbol	Item	Output Voltage	Conditions	Min.	Typ.	Max.	Unit
$I_{SS}$	Supply Current	$0.9\text{V} \leq V_{OUT} \leq 1.0\text{V}$	$V_{IN}=\text{Set } V_{OUT}+2.0\text{V}$		0.8	1.8	$\mu\text{A}$
		$1.1\text{V} \leq V_{OUT} \leq 1.4\text{V}$			1.0	2.4	
		$1.5\text{V} \leq V_{OUT} \leq 2.0\text{V}$			1.2	2.7	
		$2.1\text{V} \leq V_{OUT} \leq 4.0\text{V}$			1.5	3.0	

### RECOMMENDED OPERATING CONDITIONS (ELECTRICAL CHARACTERISTICS)

All of electronic equipment should be designed that the mounted semiconductor devices operate within the recommended operating conditions. The semiconductor devices cannot operate normally over the recommended operating conditions, even if when they are used over such conditions by momentary electronic noise or surge. And the semiconductor devices may receive serious damage when they continue to operate over the recommended operating conditions.

## OPERATION

These ICs, the output voltage  $V_{OUT}$  is detected by Feedback Resistors, and the detected output voltage is compared with a reference voltage by the error amplifier, so that a constant voltage is output.

A current limit circuit against short protection and a chip enable circuit are included.

## TEST CIRCUITS

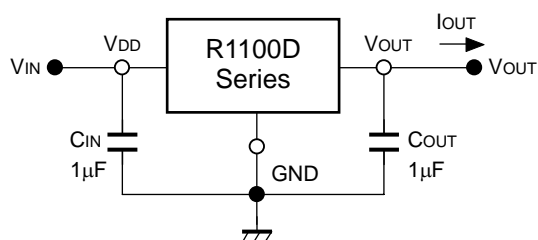

**Standard Test Circuit**

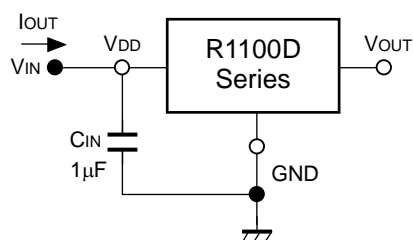

**Test Circuit for Supply Current**

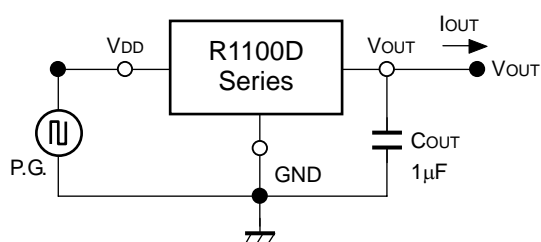

**Test Circuit for Line Transient Response**

## TECHNICAL NOTES

In R1100D Series, a constant voltage can be obtained without using capacitors. However, when the wire connected  $V_{IN}$  is long, use a capacitor. Output noise can be reduced with using capacitor.

Insert capacitors with the capacitance of  $0.1\mu\text{F}$  to  $2.2\mu\text{F}$  between input/output pins and GND pin as close as possible.

## TYPICAL CHARACTERISTICS

### 1) Output Voltage vs. Output Current





2) Output Voltage vs. Input Voltage

R1100D091C



R1100D091C



R1100D301C

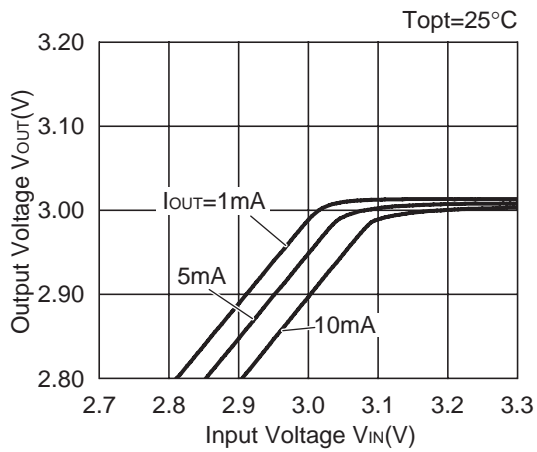

R1100D301C

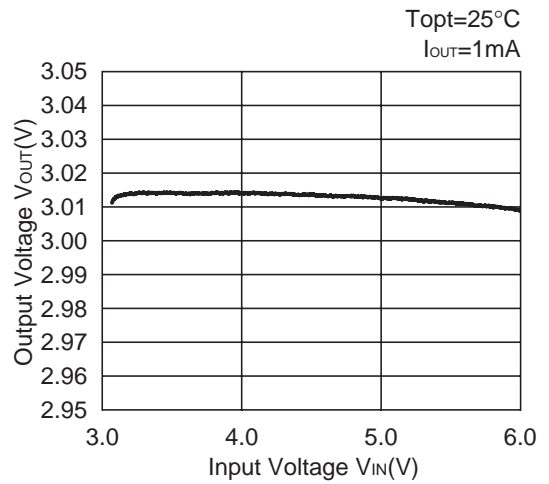

R1100D401C

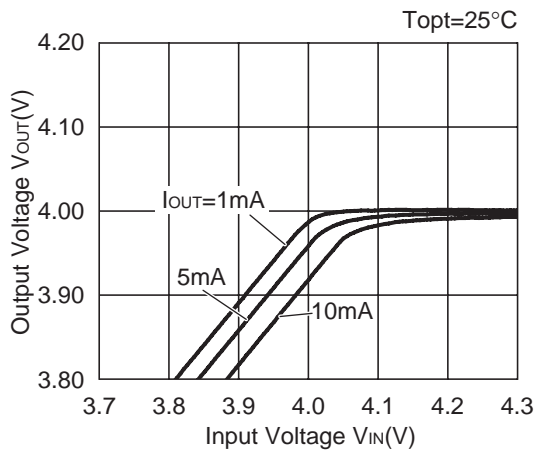

R1100D401C

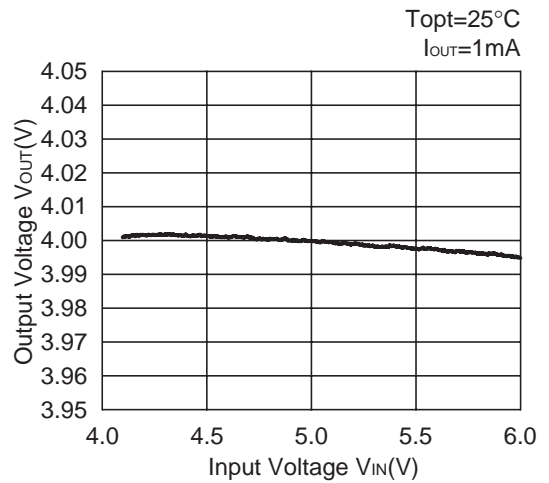

3) Dropout Voltage vs. Output Current

R1100D091C

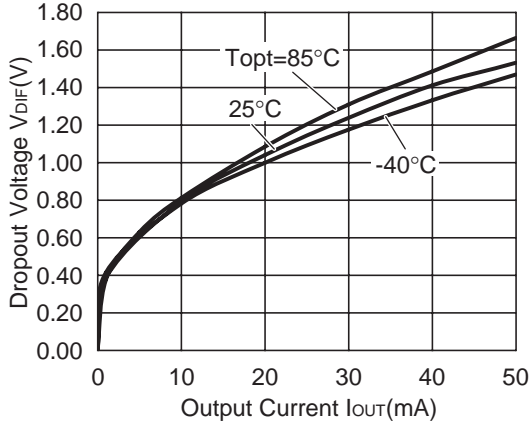

R1100D301C

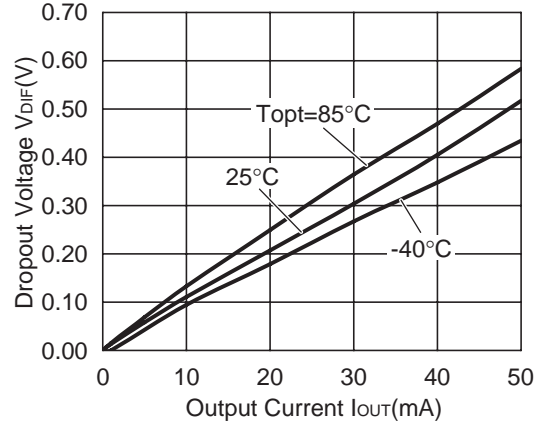

R1100D401C

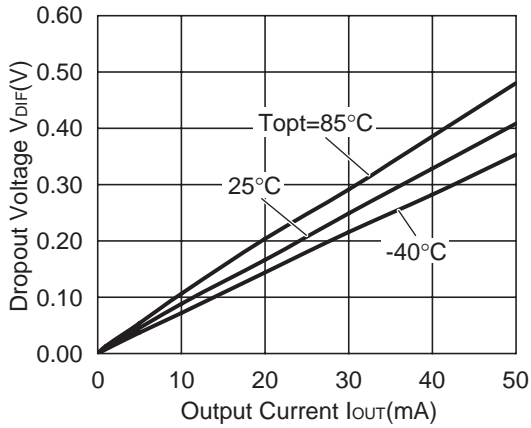

4) Output Voltage vs. Temperature

R1100D091C

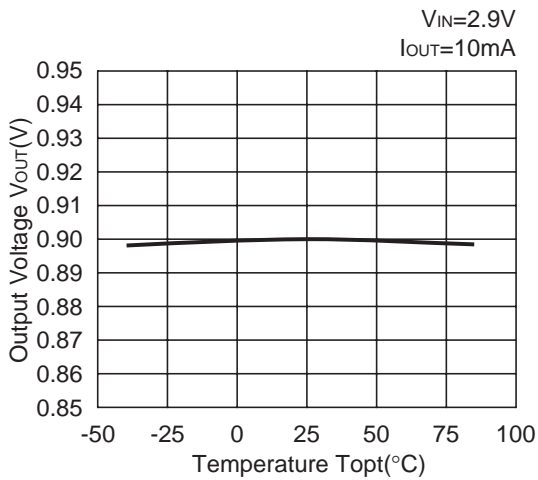

R1100D301C

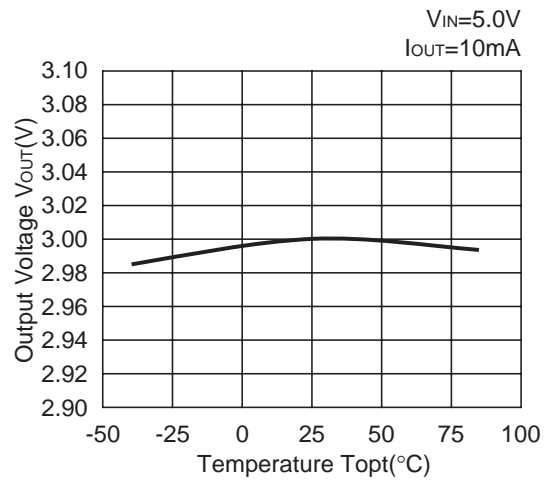

**R1100D401C**



**5) Supply Current vs. Input Voltage**

**R1100D091C**



**R1100D301C**

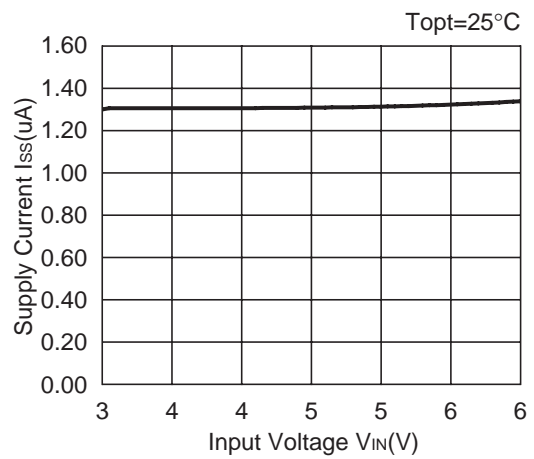

**R1100D401C**



6) Supply Current vs. Temperature

R1100D091C



R1100D301C

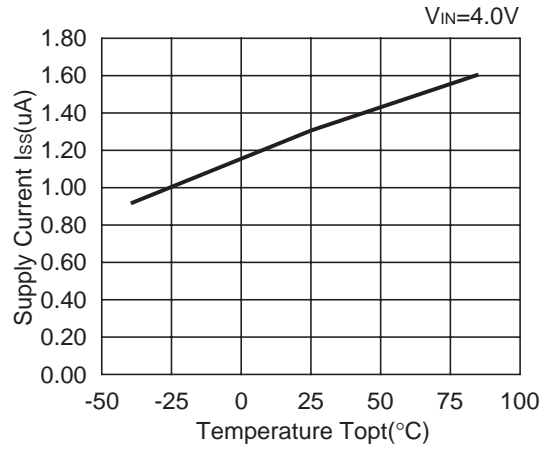

R1100D401C



7) Dropout Voltage vs. Set Output Voltage

R1100Dxx1C

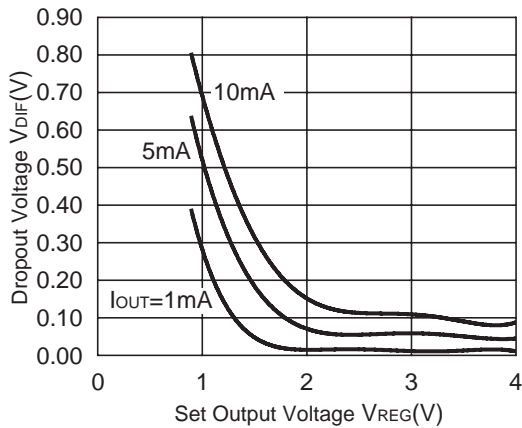

8) Line Transient Response

**R1100D091C**

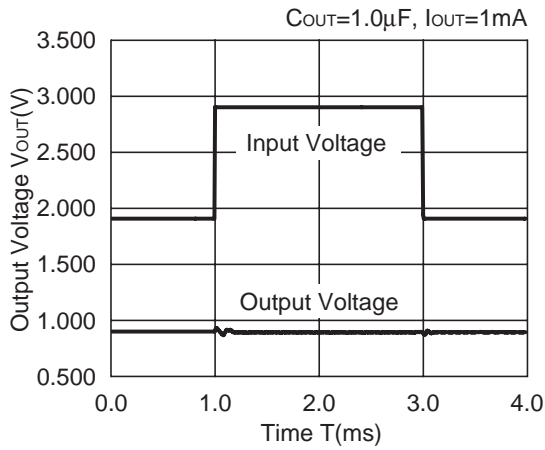

**R1100D091C**

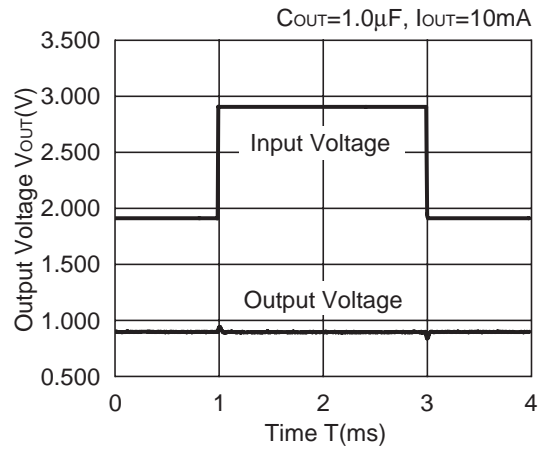

**R1100D301C**

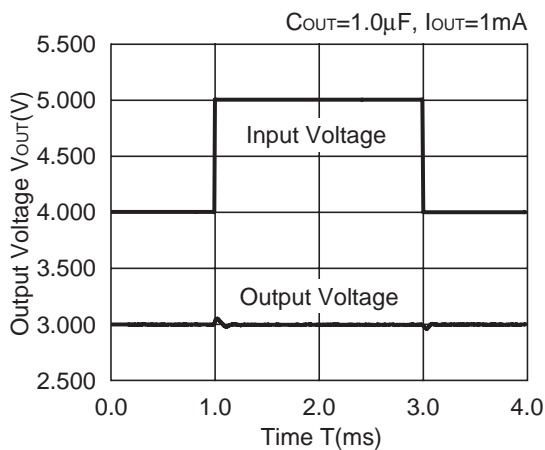

**R1100D301C**

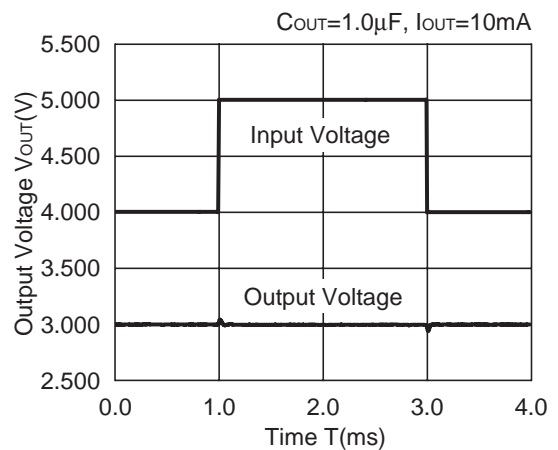

**R1100D401C**

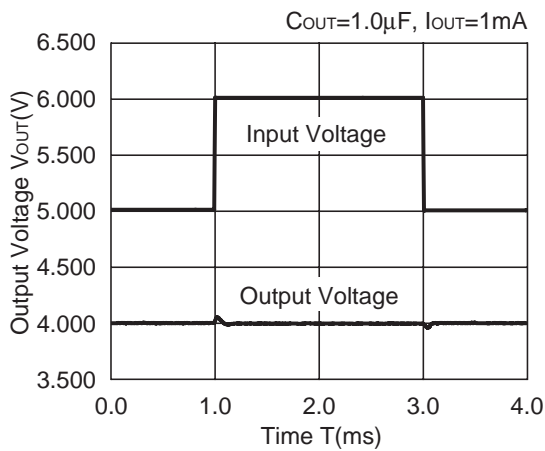

**R1100D401C**

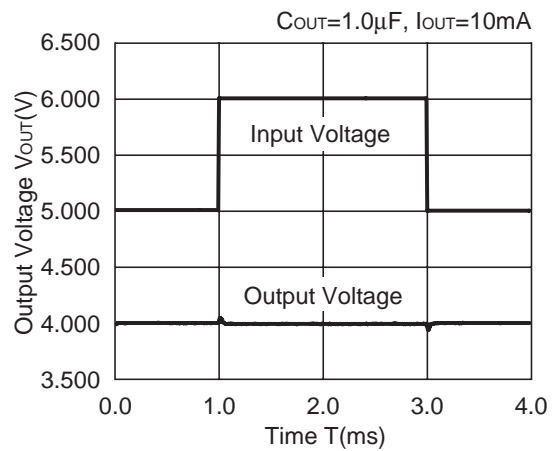

9) Load Transient Response

R1100D091C



R1100D301C

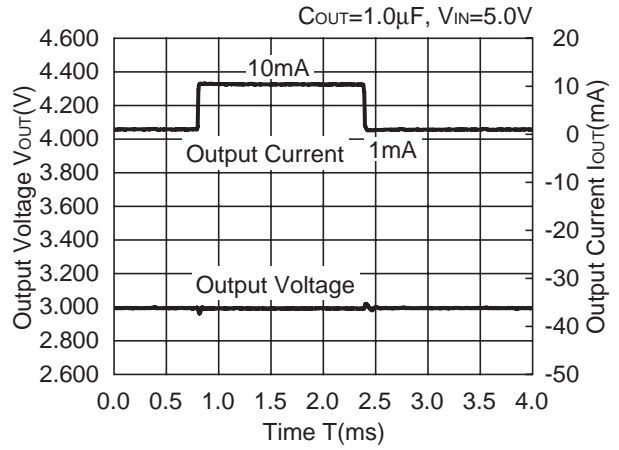

R1100D401C

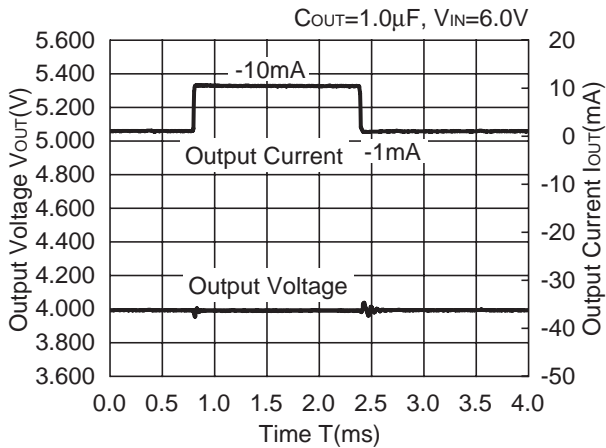

10) Ripple Rejection vs. Frequency

R1100D091C

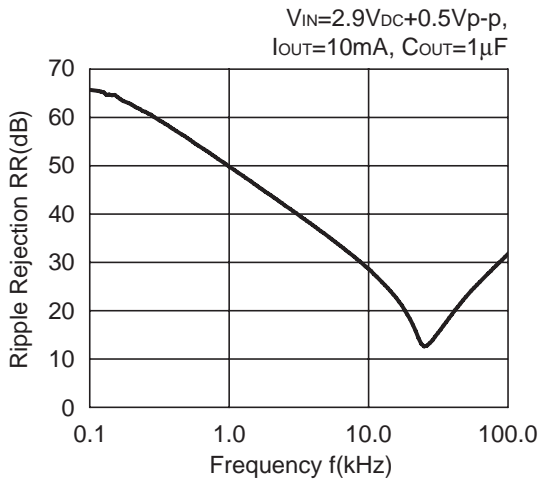

R1100D301C

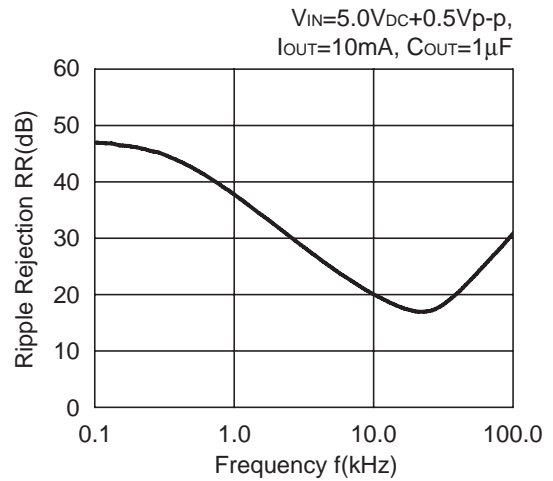

**R1100D401C**

$V_{IN}=5.5V_{DC}+0.5V_{p-p}$ ,  
 $I_{OUT}=10mA$ ,  $C_{OUT}=1\mu F$

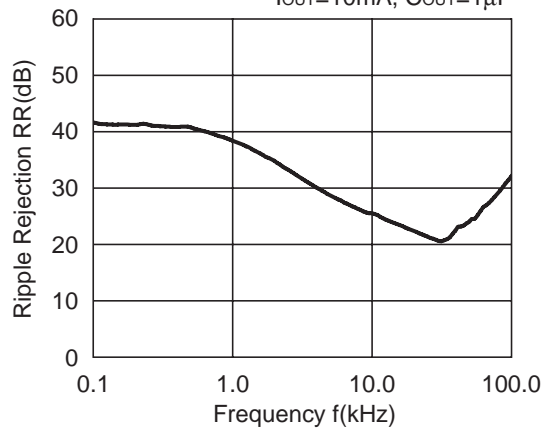



1. The products and the product specifications described in this document are subject to change or discontinuation of production without notice for reasons such as improvement. Therefore, before deciding to use the products, please refer to Ricoh sales representatives for the latest information thereon.
2. The materials in this document may not be copied or otherwise reproduced in whole or in part without prior written consent of Ricoh.
3. Please be sure to take any necessary formalities under relevant laws or regulations before exporting or otherwise taking out of your country the products or the technical information described herein.
4. The technical information described in this document shows typical characteristics of and example application circuits for the products. The release of such information is not to be construed as a warranty of or a grant of license under Ricoh's or any third party's intellectual property rights or any other rights.
5. The products listed in this document are intended and designed for use as general electronic components in standard applications (office equipment, telecommunication equipment, measuring instruments, consumer electronic products, amusement equipment etc.). Those customers intending to use a product in an application requiring extreme quality and reliability, for example, in a highly specific application where the failure or misoperation of the product could result in human injury or death (aircraft, spacevehicle, nuclear reactor control system, traffic control system, automotive and transportation equipment, combustion equipment, safety devices, life support system etc.) should first contact us.
6. We are making our continuous effort to improve the quality and reliability of our products, but semiconductor products are likely to fail with certain probability. In order to prevent any injury to persons or damages to property resulting from such failure, customers should be careful enough to incorporate safety measures in their design, such as redundancy feature, fire containment feature and fail-safe feature. We do not assume any liability or responsibility for any loss or damage arising from misuse or inappropriate use of the products.
7. Anti-radiation design is not implemented in the products described in this document.
8. Please contact Ricoh sales representatives should you have any questions or comments concerning the products or the technical information.



**Ricoh is committed to reducing the environmental loading materials in electrical devices with a view to contributing to the protection of human health and the environment.**

Ricoh has been providing RoHS compliant products since April 1, 2006 and Halogen-free products since April 1, 2012.

**RICOH** RICOH ELECTRONIC DEVICES CO., LTD.

<http://www.e-devices.ricoh.co.jp/en/>

#### Sales & Support Offices

##### **RICOH ELECTRONIC DEVICES CO., LTD.**

**Higashi-Shinagawa Office (International Sales)**  
3-32-3, Higashi-Shinagawa, Shinagawa-ku, Tokyo 140-8655, Japan  
Phone: +81-3-5479-2857 Fax: +81-3-5479-0502

##### **RICOH EUROPE (NETHERLANDS) B.V.**

**Semiconductor Support Centre**  
Prof. W.H. Keesomlaan 1, 1183 DJ Amstelveen, The Netherlands  
Phone: +31-20-5474-309

##### **RICOH ELECTRONIC DEVICES KOREA CO., LTD.**

3F, Haesung Bldg. 504, Teheran-ro, Gangnam-gu, Seoul, 135-725, Korea  
Phone: +82-2-2135-5700 Fax: +82-2-2051-5713

##### **RICOH ELECTRONIC DEVICES SHANGHAI CO., LTD.**

Room 403, No.2 Building, No.690 Bilbo Road, Pu Dong New District, Shanghai 201203, People's Republic of China  
Phone: +86-21-5027-3200 Fax: +86-21-5027-3299

##### **RICOH ELECTRONIC DEVICES CO., LTD.**

**Taipei office**  
Room 109, 10F-1, No.51, Hengyang Rd., Taipei City, Taiwan (R.O.C.)  
Phone: +886-2-2313-1621/1622 Fax: +886-2-2313-1623



# Mouser Electronics

Authorized Distributor

Click to View Pricing, Inventory, Delivery & Lifecycle Information:

## Ricoh Electronics:

[R1100D331C-TR-F](#) [R1100D101C-TR-F](#) [R1100D201C-TR-F](#) [R1100D301C-TR-F](#) [R1100D181C-TR-F](#) [R1100D121C-TR-F](#) [R1100D381C-TR-F](#) [R1100D221C-TR-F](#)

## Данный компонент на территории Российской Федерации

### Вы можете приобрести в компании MosChip.

Для оперативного оформления запроса Вам необходимо перейти по данной ссылке:

<http://moschip.ru/get-element>

Вы можете разместить у нас заказ для любого Вашего проекта, будь то серийное производство или разработка единичного прибора.

В нашем ассортименте представлены ведущие мировые производители активных и пассивных электронных компонентов.

Нашей специализацией является поставка электронной компонентной базы двойного назначения, продукции таких производителей как XILINX, Intel (ex.ALTERA), Vicor, Microchip, Texas Instruments, Analog Devices, Mini-Circuits, Amphenol, Glenair.

Сотрудничество с глобальными дистрибьюторами электронных компонентов, предоставляет возможность заказывать и получать с международных складов практически любой перечень компонентов в оптимальные для Вас сроки.

На всех этапах разработки и производства наши партнеры могут получить квалифицированную поддержку опытных инженеров.

Система менеджмента качества компании отвечает требованиям в соответствии с ГОСТ Р ИСО 9001, ГОСТ РВ 0015-002 и ЭС РД 009

### Офис по работе с юридическими лицами:

105318, г.Москва, ул.Щербаковская д.3, офис 1107, 1118, ДЦ «Щербаковский»

Телефон: +7 495 668-12-70 (многоканальный)

Факс: +7 495 668-12-70 (доб.304)

E-mail: [info@moschip.ru](mailto:info@moschip.ru)

Skype отдела продаж:

moschip.ru

moschip.ru\_4

moschip.ru\_6

moschip.ru\_9