

**PRELIMINARY**

**Cree® XLamp® XQ-A LEDs**

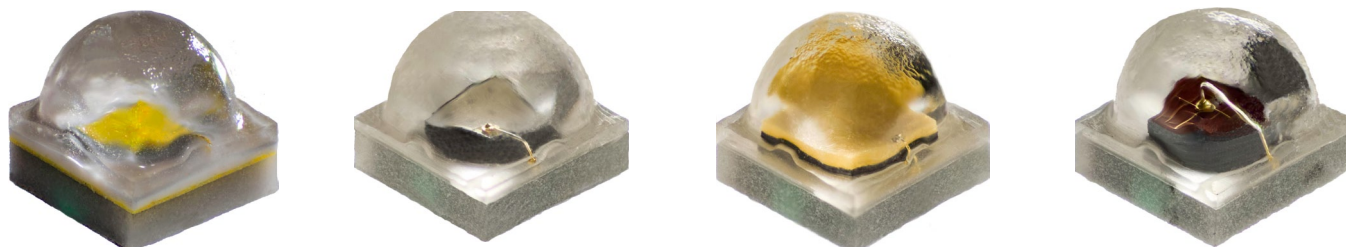

**PRODUCT DESCRIPTION**

The XLamp® XQ-A LED is Cree’s newest family of ½-watt high-power LEDs. The XQ-A features the same form factor as the high performance XQ-E device enabling lighting manufacturers to offer multiple performance options from the same LED footprint.

The new XQ-A is available in white and the full spectrum of colors enabling a wide variety of lighting applications such as directional, architectural and emergency vehicle lighting. The XQ-A’s consistent design across all configurations and its small size permit optimum color mixing and optical control.

**FEATURES**

- Cree’s smallest lighting class LED: 1.6 X 1.6 mm
- Available in 70-, 80- & 90-CRI white, and royal blue, blue, green, PC amber, red-orange & red
- 350 mA maximum drive current
- Wide viewing angle: white: 100°, royal blue, blue, PC amber: 105°, green, red-orange, red: 110°
- Reflow solderable - JEDEC J-STD-020C compatible
- Unlimited floor life at ≤ 30 °C/85% RH
- RoHS-compliant

**TABLE OF CONTENTS**

Characteristics .....2

Flux Characteristics - White.....3

Flux Characteristics - Color .....4

Relative Spectral Power Distribution .....6

Relative Flux vs. Junction Temperature.7

Electrical Characteristics.....8

Relative Flux vs. Current .....9

Relative Chromaticity vs. Current and Temperature .....11

Typical Spatial Distribution.....12

Thermal Design .....13

Reflow Soldering Characteristics.....14

Notes .....15

Mechanical Dimensions .....16

Tape and Reel.....17

Packaging.....18

# PRELIMINARY

## CHARACTERISTICS

Characteristics	Unit	Minimum	Typical	Maximum
Thermal resistance, junction to solder point - white	°C/W		20	
Thermal resistance, junction to solder point - royal blue, blue	°C/W		17	
Thermal resistance, junction to solder point - green	°C/W		35	
Thermal resistance, junction to solder point - PC amber	°C/W		21	
Thermal resistance, junction to solder point - red-orange, red	°C/W		15	
Viewing angle (FWHM) - white	degrees		100	
Viewing angle (FWHM) - royal blue, blue, PC amber	degrees		105	
Viewing angle (FWHM) - green, red-orange, red	degrees		110	
Temperature coefficient of voltage - white	mV/°C		-2.8	
Temperature coefficient of voltage - royal blue, blue	mV/°C		-3.6	
Temperature coefficient of voltage - green	mV/°C		-4.2	
Temperature coefficient of voltage - PC amber	mV/°C		-3.4	
Temperature coefficient of voltage - red-orange, red	mV/°C		-2.0	
ESD withstand voltage (HBM per Mil-Std-883D)- white, royal blue, blue, green, red-orange, red			Class 3A	
ESD classification (HBM per Mil-Std-883D) - PC amber			Class 2	
DC forward current	mA			350
Reverse voltage	V			5
Forward voltage (@ 175 mA, 85 °C) - white	V		3.0	3.3
Forward voltage (@ 175 mA, 25 °C) - royal blue, blue, PC amber	V		3.2	3.5
Forward voltage (@ 175 mA, 25 °C) - green	V		3.3	3.6
Forward voltage (@ 175 mA, 25 °C) - red-orange, red	V		2.3	2.6
LED junction temperature	°C			150

## PRELIMINARY

### FLUX CHARACTERISTICS - WHITE ( $T_j = 85\text{ }^\circ\text{C}$ )

The following table provides several base order codes for XLamp XQ-A white LEDs. It is important to note that the base order codes listed here are a subset of the total available order codes for the product family. For more order codes, as well as a complete description of the order-code nomenclature, please consult the XLamp XQ Family LEDs Binning and Labeling document.

Color	CCT Range		Minimum Luminous Flux @ 175 mA			Calculated Minimum Luminous Flux (lm)** @ 85 °C	Order Code
	Minimum	Maximum	Group	Flux (lm) @ 85 °C	Flux (lm) @ 25 °C*	350 mA	
Cool White	5000 K	8300 K	M3	45.7	53.1	75.3	XQAAWT-00-0000-00000L3E2
			N2	51.7	60.1	85.1	XQAAWT-00-0000-00000L4E2
			N3	56.8	66	93.5	XQAAWT-00-0000-00000L5E2
70-CRI White	3700 K	8300 K	M3	45.7	53.1	75.5	XQAAWT-00-0000-00000B3E2
			N2	51.7	60.1	85.1	XQAAWT-00-0000-00000B4E2
			N3	56.8	66	93.5	XQAAWT-00-0000-00000B5E2
Neutral White	3700 K	5300 K	M3	45.7	53.1	75.5	XQAAWT-00-0000-00000L3E4
			N2	51.7	60.1	85.1	XQAAWT-00-0000-00000L4E4
Warm White	2700 K	3500 K	K3	35.2	40.9	58.0	XQAAWT-00-0000-00000LZE7
			M2	39.8	46.2	65.5	XQAAWT-00-0000-00000L2E7
			M3	45.7	53.1	75.5	XQAAWT-00-0000-00000L3E7
80-CRI White	2700 K	3500 K	K3	35.2	40.9	58.0	XQAAWT-00-0000-00000HZE7
			M2	39.8	46.2	65.5	XQAAWT-00-0000-00000H2E7
			M3	45.7	53.1	75.5	XQAAWT-00-0000-00000H3E7
90-CRI White	2850 K	3000 K	K2	30.6	34.6	48.5	XQAAWT-00-0000-00000UYE7
			K3	35.2	40.9	58.0	XQAAWT-00-0000-00000UZE7

**Notes:**

- Cree maintains a tolerance of  $\pm 7\%$  on flux and power measurements,  $\pm 0.005$  on chromaticity (CCx, CCy) measurements and  $\pm 2$  on CRI measurements. See the Measurements section (page 15).
- Typical CRI for Cool White (5000 K – 8300 K CCT) is 70.
- Typical CRI for Neutral White (3700 K – 5300 K CCT) is 75.
- Typical CRI for Warm White (2600 K – 3700 K CCT) is 80.
- Minimum CRI for 70-CRI White is 70.
- Minimum CRI for 80-CRI White is 80.
- Minimum CRI for 90-CRI White is 90.
- \* Flux values @ 25 °C are calculated and for reference only.
- \*\* Calculated flux value at 350 mA is for reference only.

## PRELIMINARY

### FLUX CHARACTERISTICS - COLOR ( $T_j = 25\text{ }^\circ\text{C}$ )

The following table provides several base order codes for XLamp XQ-A color LEDs. It is important to note that the base order codes listed here are a subset of the total available order codes for the product family. For more order codes, as well as a complete description of the order-code nomenclature, please consult the XLamp XQ Family LEDs Binning and Labeling document.

Color	Dominant Wavelength Range				Minimum Radiant Flux @ 175 mA		Order Code
	Minimum		Maximum		Group	Flux (mW)	
	Group	DWL (nm)	Group	DWL (nm)			
Royal Blue	D36	450	D57	465	11	210	XQAROY-00-0000-000000601
					12	250	XQAROY-00-0000-000000701

Color	Dominant Wavelength Range				Minimum Luminous Flux @ 175 mA		Order Code
	Minimum		Maximum		Group	Flux (lm)	
	Group	DWL (nm)	Group	DWL (nm)			
Blue	B3	465	B6	485	G2	13.9	XQABLU-00-0000-000000U01

Color	Dominant Wavelength Range				Minimum Luminous Flux @ 175 mA		Order Code
	Minimum		Maximum		Group	Flux (lm)	
	Group	DWL (nm)	Group	DWL (nm)			
Green	G2	520	G4	535	K2	30.6	XQAGRN-00-0000-000000Y01
					K3	35.2	XQAGRN-00-0000-000000Z01
					M2	39.8	XQAGRN-00-0000-000000Z01

Color	Color Bin	Minimum Luminous Flux @ 175 mA		Order Code
		Group	Flux (lm)	
PC Amber	Y2	K2	30.6	XQAAPA-00-0000-000000Y01
		K3	35.2	XQAAPA-00-0000-000000Z01

Color	Dominant Wavelength Range				Minimum Luminous Flux @ 175 mA		Order Code
	Minimum		Maximum		Group	Flux (lm)	
	Group	DWL (nm)	Group	DWL (nm)			
Red-Orange	O3	610	O4	620	K2	30.6	XQARDO-00-0000-000000Y01
					K3	35.2	XQARDO-00-0000-000000Z01

**PRELIMINARY**

**FLUX CHARACTERISTICS - COLOR ( $T_j = 25\text{ }^\circ\text{C}$ ) - CONTINUED**

Color	Dominant Wavelength Range				Minimum Luminous Flux @ 175 mA		Order Code
	Minimum		Maximum		Group	Flux (lm)	
	Group	DWL (nm)	Group	DWL (nm)			
Red	R2	620	R3	630	J2	23.5	XQARED-00-0000-000000W01

**PRELIMINARY**

**RELATIVE SPECTRAL POWER DISTRIBUTION**

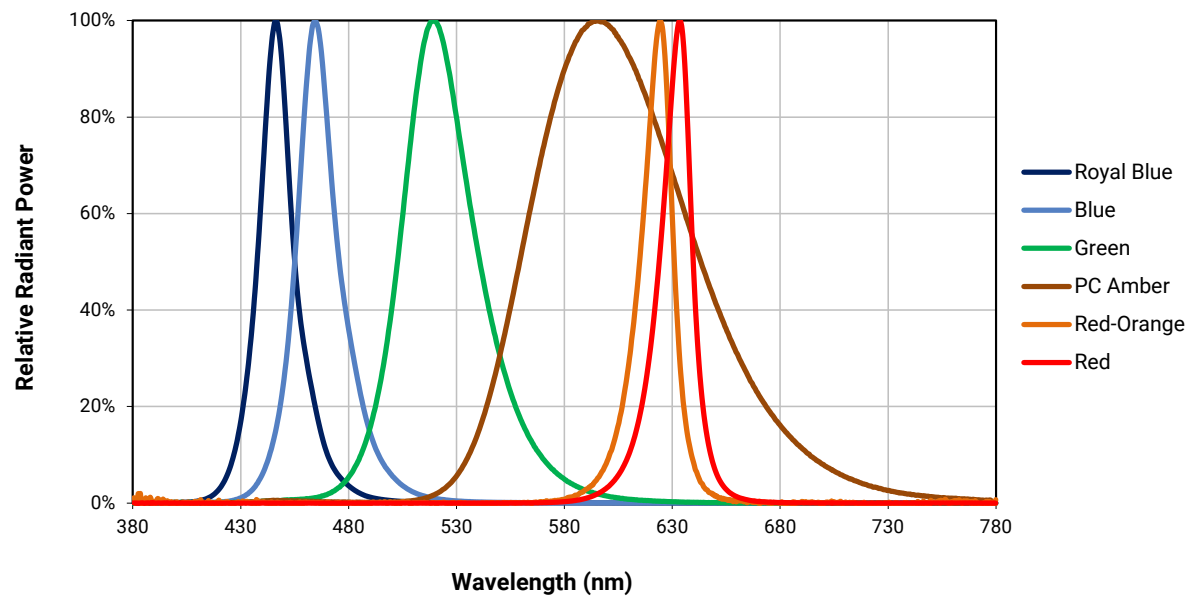
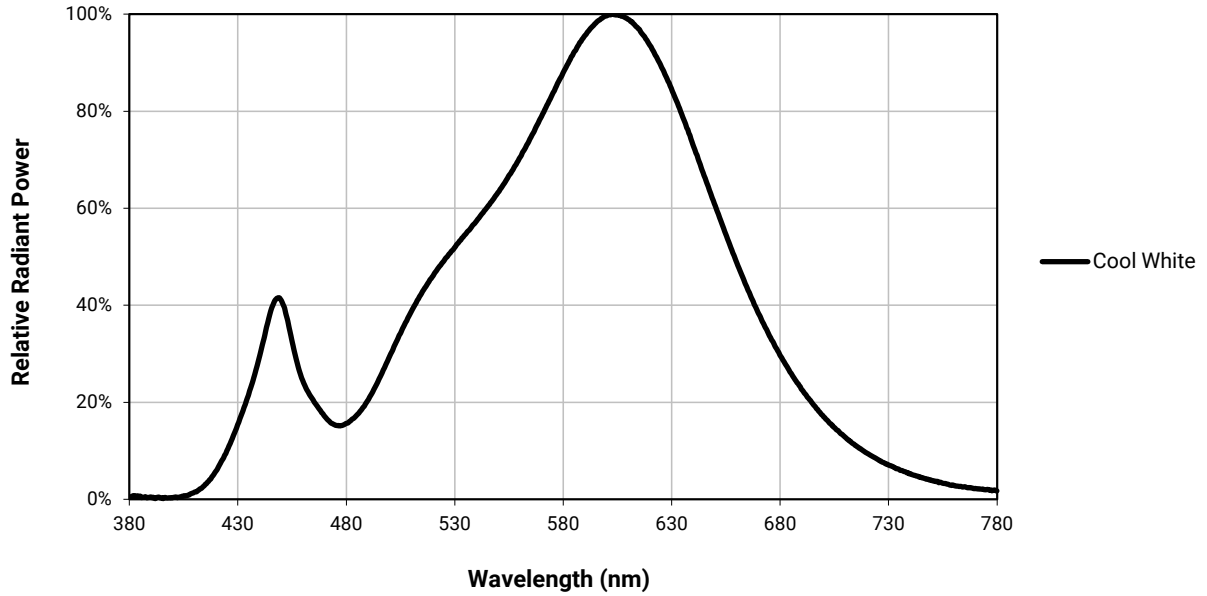

**PRELIMINARY**

**RELATIVE FLUX VS. JUNCTION TEMPERATURE ( $I_F = 175 \text{ mA}$ )**

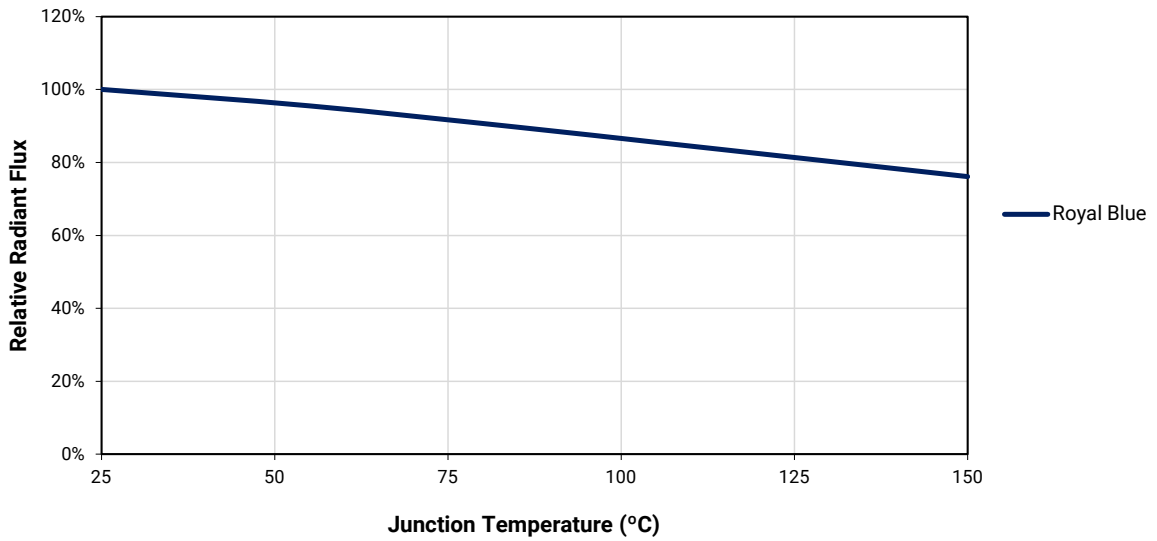
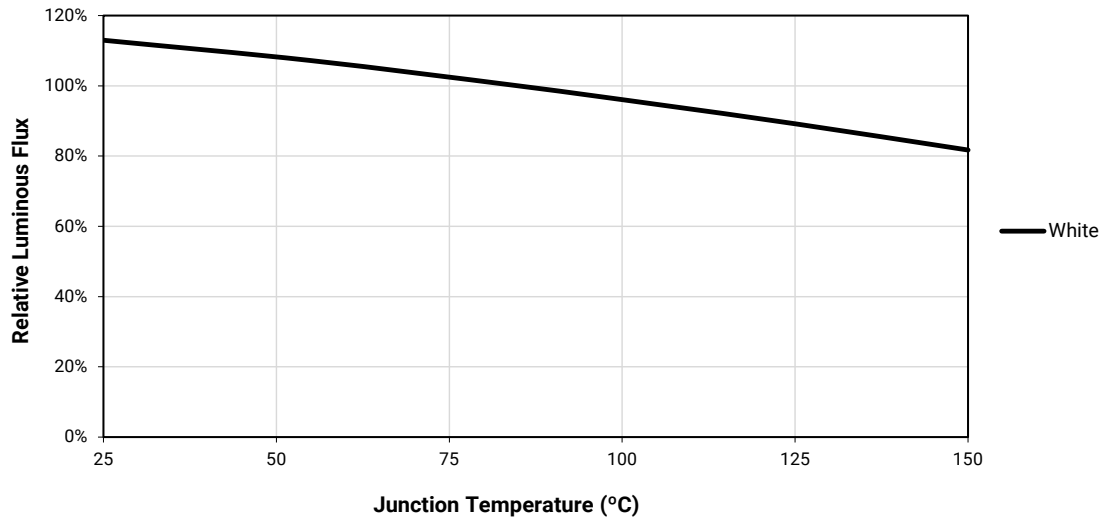

**PRELIMINARY**

**RELATIVE FLUX VS. JUNCTION TEMPERATURE ( $I_f = 175 \text{ mA}$ ) - CONTINUED**

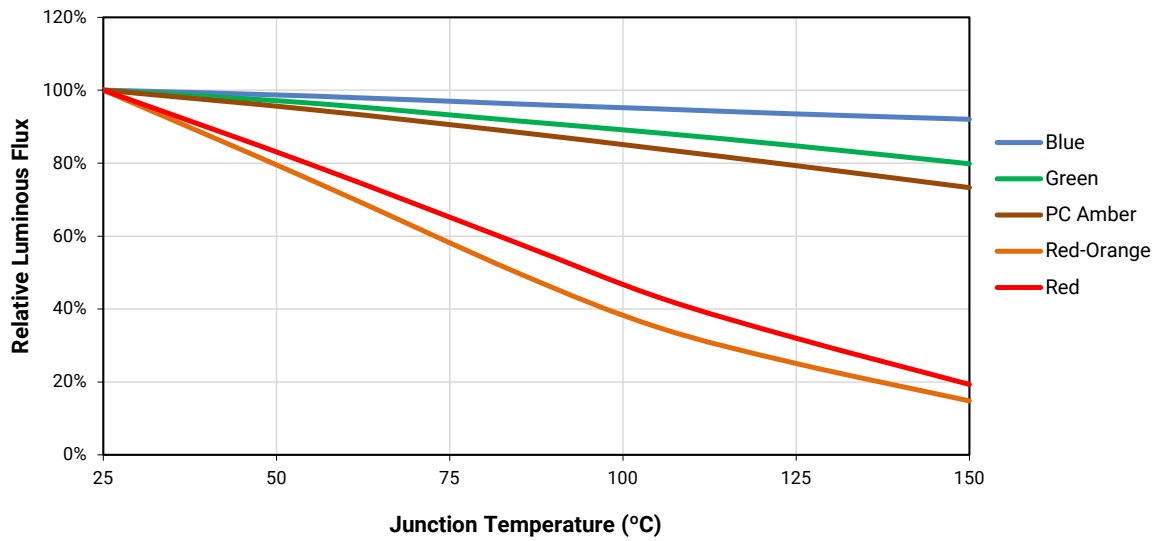

**ELECTRICAL CHARACTERISTICS ( $T_j = 85 \text{ °C}$ )**

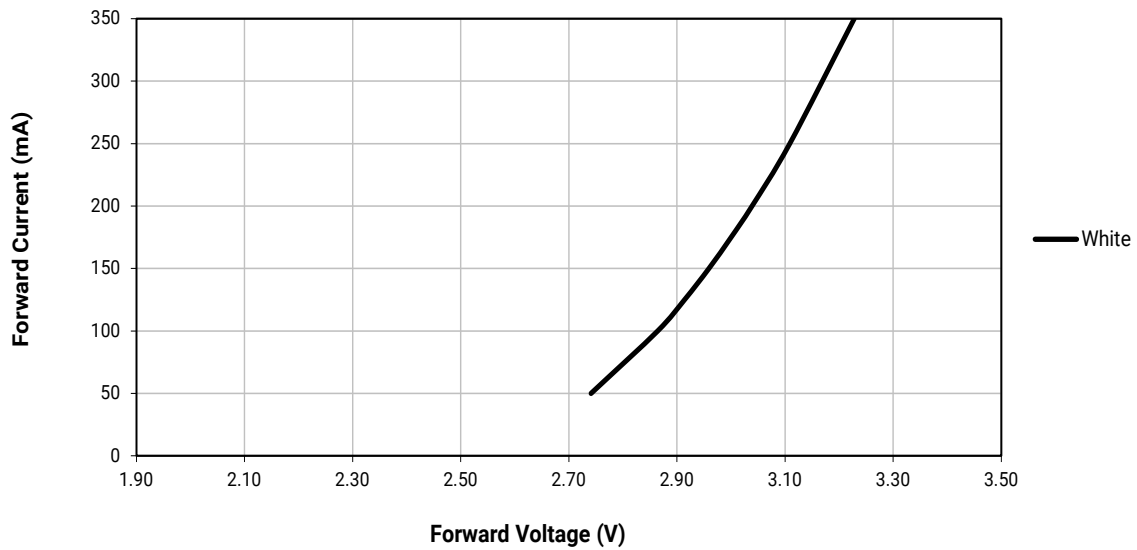



**PRELIMINARY**

**ELECTRICAL CHARACTERISTICS ( $T_j = 25\text{ }^\circ\text{C}$ )**

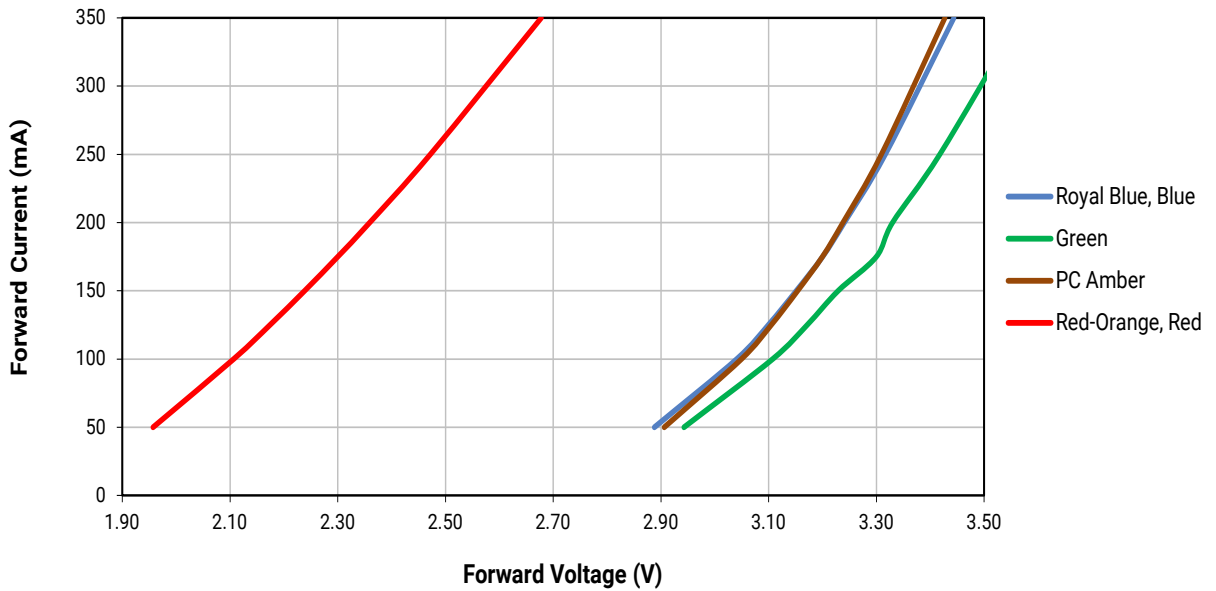

**RELATIVE FLUX VS. CURRENT ( $T_j = 85\text{ }^\circ\text{C}$ )**

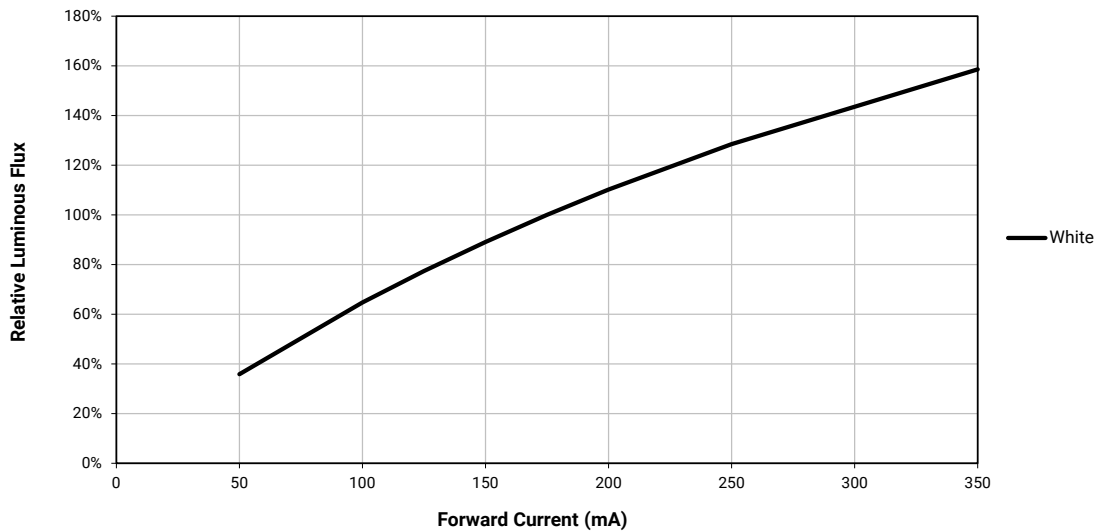

PRELIMINARY

RELATIVE FLUX VS. CURRENT ( $T_j = 25\text{ }^\circ\text{C}$ )

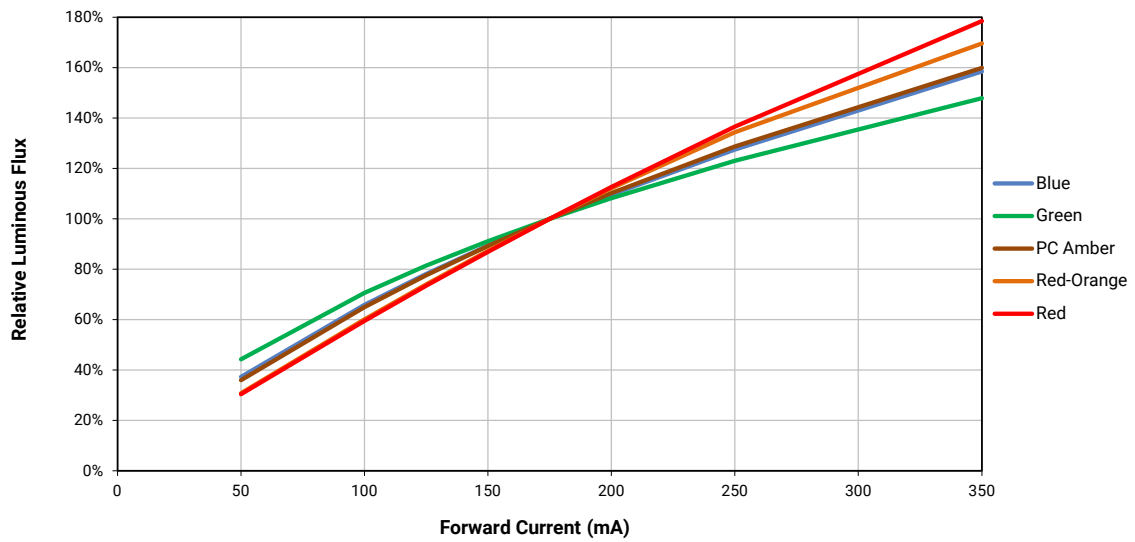
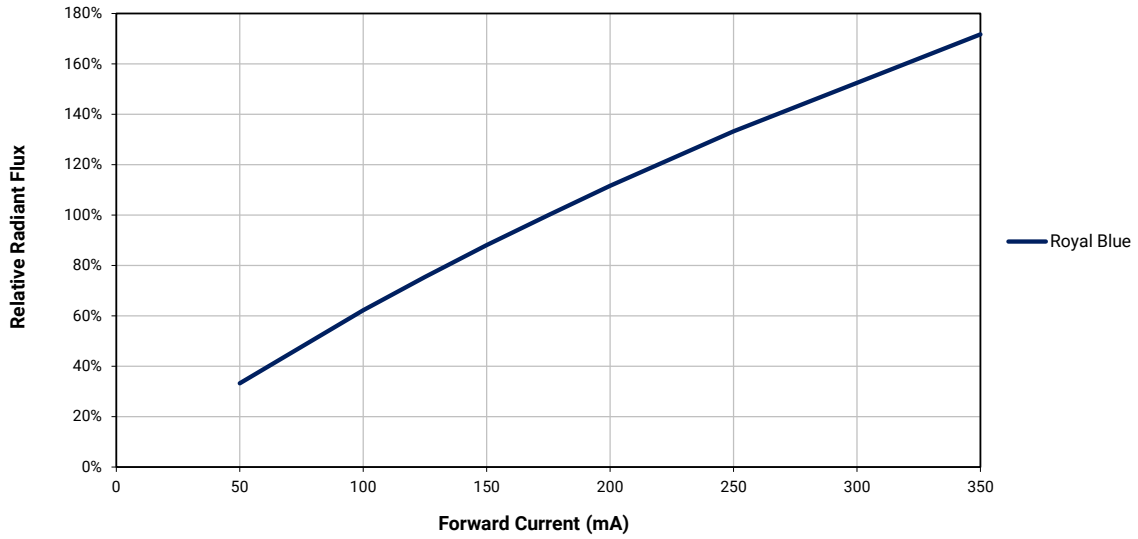

## PRELIMINARY

### RELATIVE CHROMATICITY VS. CURRENT AND TEMPERATURE (WARM WHITE)

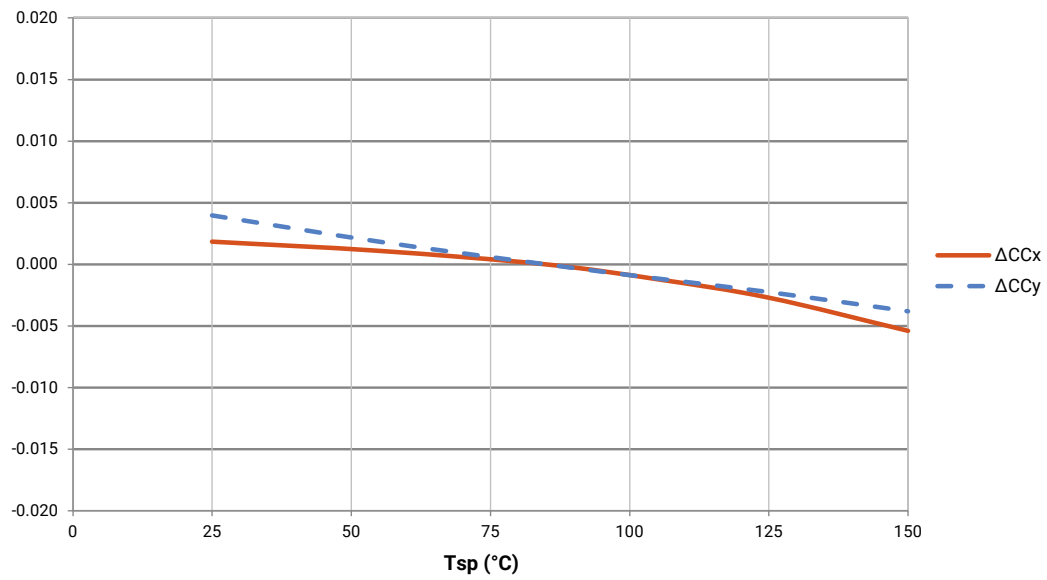
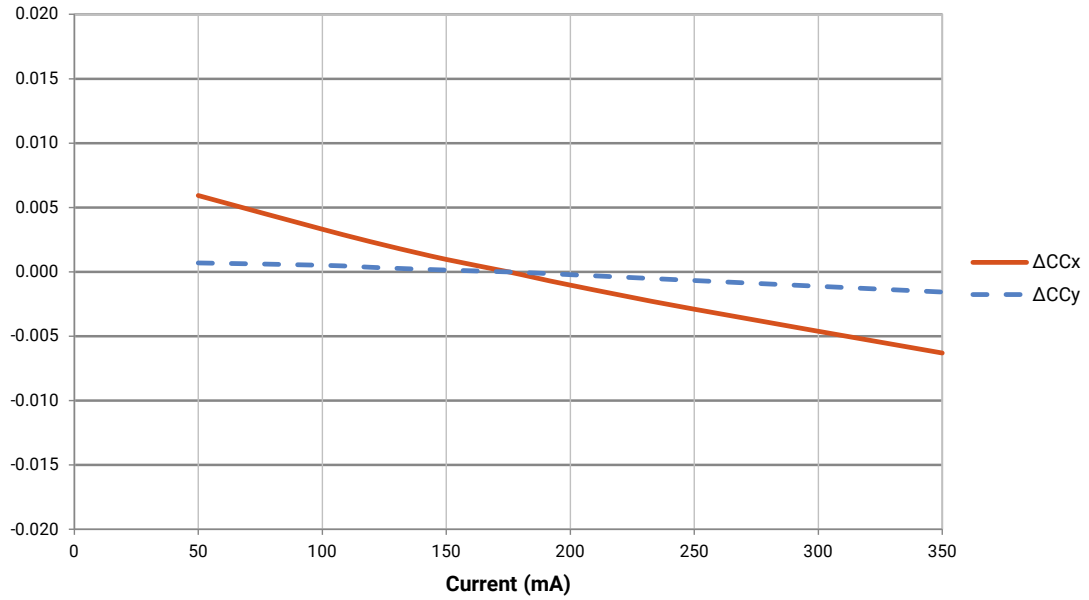

**PRELIMINARY**

**TYPICAL SPATIAL DISTRIBUTION**

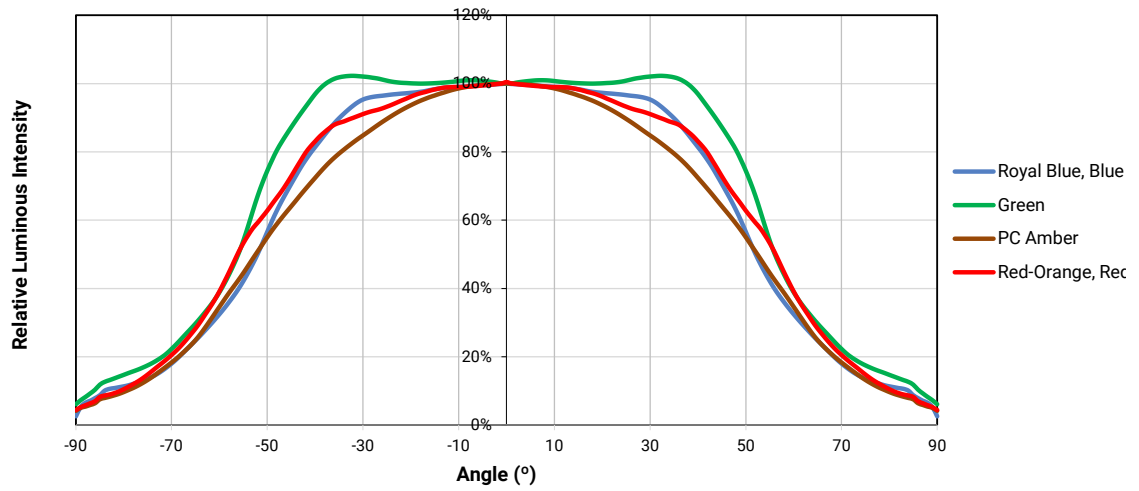
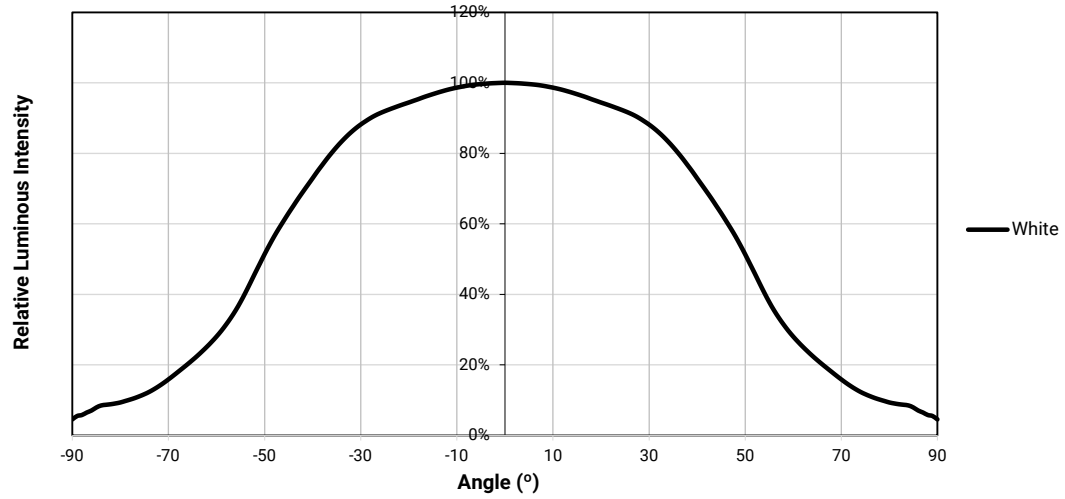

# PRELIMINARY

## THERMAL DESIGN

The maximum forward current is determined by the thermal resistance between the LED junction and ambient. It is crucial for the end product to be designed in a manner that minimizes the thermal resistance from the solder point to ambient in order to optimize lamp life and optical characteristics.

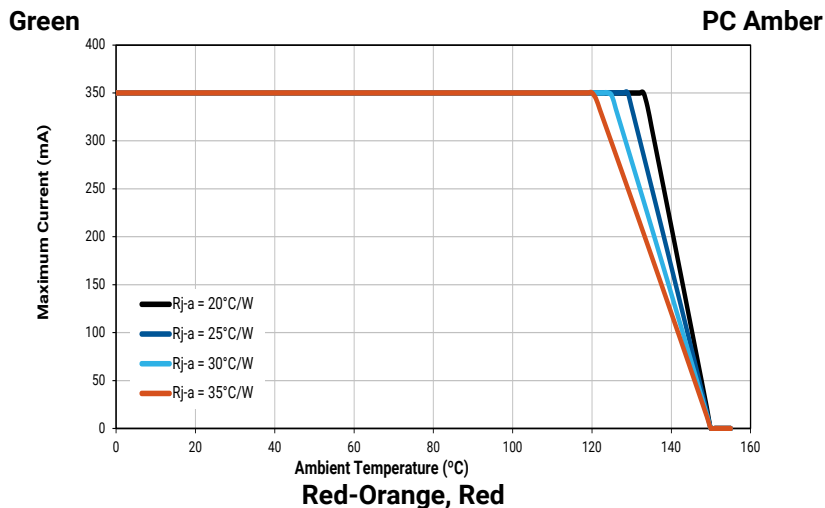
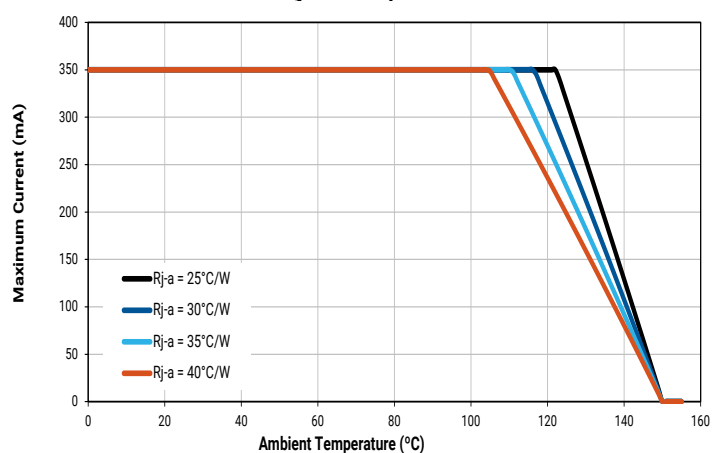
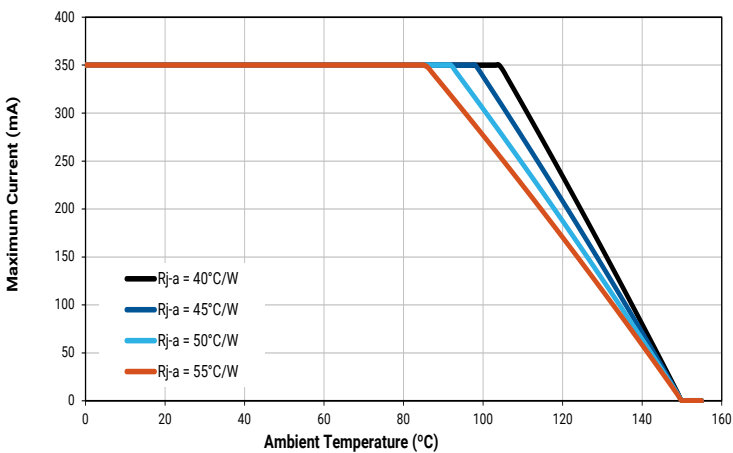
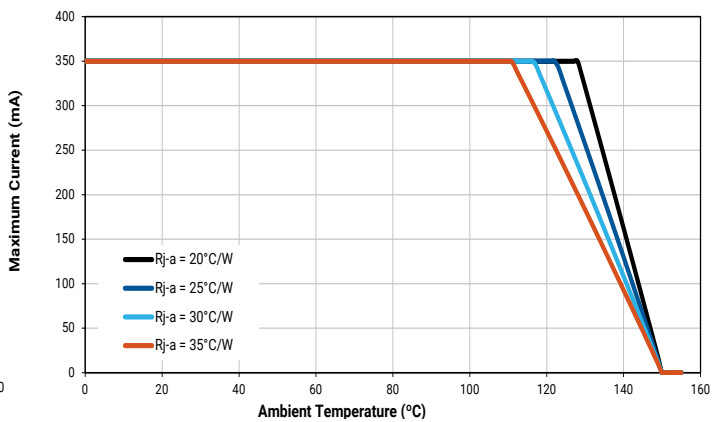
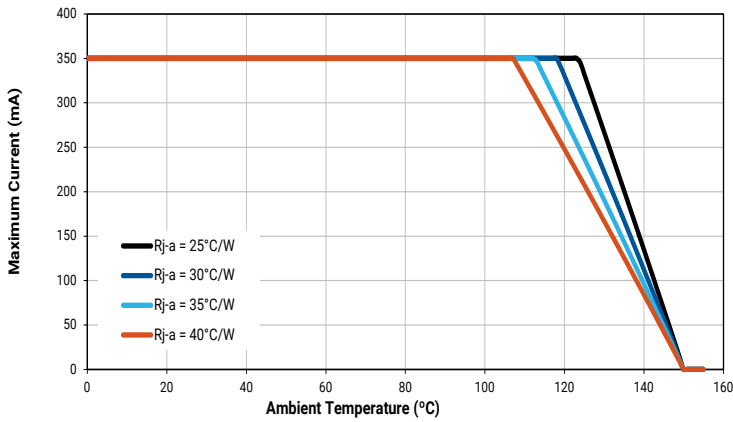

# PRELIMINARY

## REFLOW SOLDERING CHARACTERISTICS

In testing, Cree has found XLamp XQ-A LEDs to be compatible with JEDEC J-STD-020C, using the parameters listed below. As a general guideline, Cree recommends that users follow the recommended soldering profile provided by the manufacturer of the solder paste used.

Note that this general guideline may not apply to all PCB designs and configurations of reflow soldering equipment.

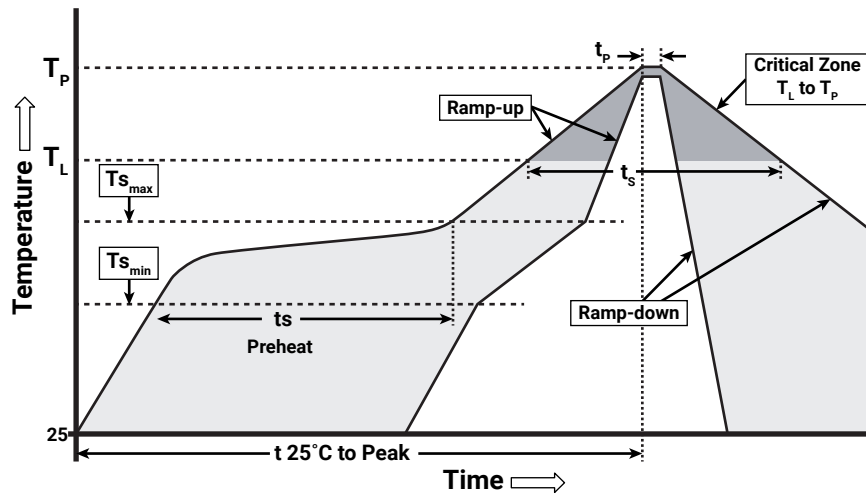

IPC/JEDEC J-STD-020C

Profile Feature	Lead-Free Solder
Average Ramp-Up Rate ( $T_{s\_max}$ to $T_P$ )	1.2 °C/second
Preheat: Temperature Min ( $T_{s\_min}$ )	120 °C
Preheat: Temperature Max ( $T_{s\_max}$ )	170 °C
Preheat: Time ( $t_{s\_min}$ to $t_{s\_max}$ )	65-150 seconds
Time Maintained Above: Temperature ( $T_L$ )	217 °C
Time Maintained Above: Time ( $t_s$ )	45-90 seconds
Peak/Classification Temperature ( $T_P$ )	235 - 245 °C
Time Within 5 °C of Actual Peak Temperature ( $t_p$ )	20-40 seconds
Ramp-Down Rate	1 - 6 °C/second
Time 25 °C to Peak Temperature	4 minutes max.

Note: All temperatures refer to topside of the package, measured on the package body surface.

## PRELIMINARY

### NOTES

---

#### Measurements

The luminous flux, radiant power, chromaticity and CRI measurements in this document are binning specifications only and solely represent product measurements as of the date of shipment. These measurements will change over time based on a number of factors that are not within Cree's control and are not intended or provided as operational specifications for the products. Calculated values are provided for informational purposes only and are not intended as specifications.

#### Pre-Release Qualification Testing

Please read the [LED Reliability Overview](#) for details of the qualification process Cree applies to ensure long-term reliability for XLamp LEDs and details of Cree's pre-release qualification testing for XLamp LEDs. Cree did not perform Room Temperature Operating Life (RTOL) testing on the XQ-A LED.

#### Lumen Maintenance

Cree now uses standardized IES LM-80-08 and TM-21-11 methods for collecting long-term data and extrapolating LED lumen maintenance. For information on the specific LM-80 data sets available for this LED, refer to the public [LM-80 results document](#).

Please read the [Long-Term Lumen Maintenance application note](#) for more details on Cree's lumen maintenance testing and forecasting. Please read the [Thermal Management application note](#) for details on how thermal design, ambient temperature, and drive current affect the LED junction temperature.

#### Moisture Sensitivity

Cree recommends keeping XLamp LEDs in the provided, resealable moisture-barrier packaging (MBP) until immediately prior to soldering. Unopened MBPs that contain XLamp LEDs do not need special storage for moisture sensitivity.

Once the MBP is opened, XLamp XQ-A LEDs may be stored as MSL 1 per JEDEC J-STD-033, meaning they have unlimited floor life in conditions of  $\leq 30$  °C/85% relative humidity (RH). Regardless of storage condition, Cree recommends sealing any unsoldered LEDs in the original MBP.

#### RoHS Compliance

The levels of RoHS restricted materials in this product are below the maximum concentration values (also referred to as the threshold limits) permitted for such substances, or are used in an exempted application, in accordance with EU Directive 2011/65/EC (RoHS2), as implemented January 2, 2013. RoHS Declarations for this product can be obtained from your Cree representative or from the Product Documentation sections of [www.cree.com](http://www.cree.com).

#### Vision Advisory

WARNING: Do not look at an exposed lamp in operation. Eye injury can result. For more information about LEDs and eye safety, please refer to the [LED Eye Safety application note](#).

**PRELIMINARY**

**MECHANICAL DIMENSIONS**

Thermal vias, if present, are not shown on these drawings.

All dimensions in mm.

Measurement tolerances unless indicated otherwise:  $\pm 0.13$  mm

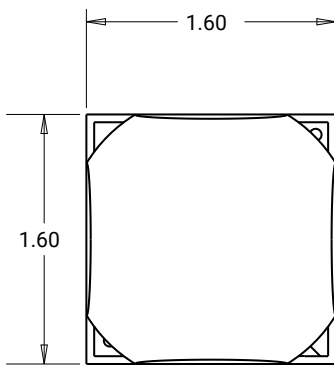

**Top View**

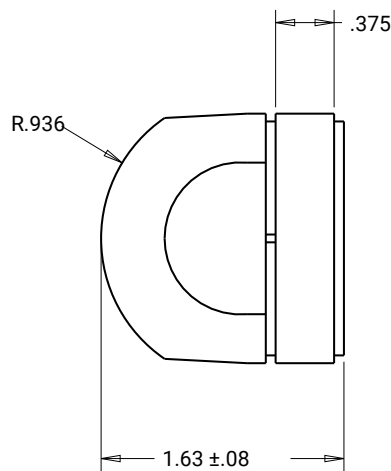

**Side View**

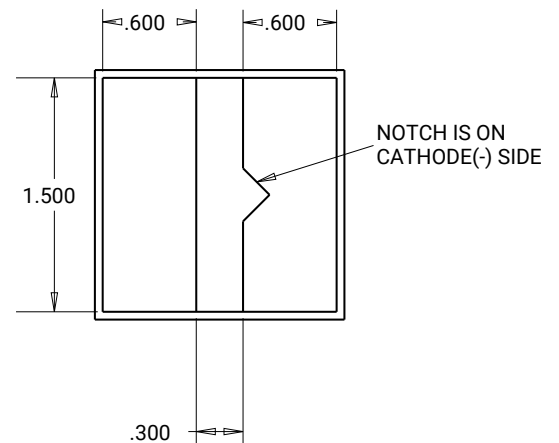

**Bottom View**

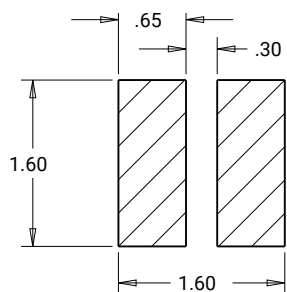

**Recommended PCB solder pad**

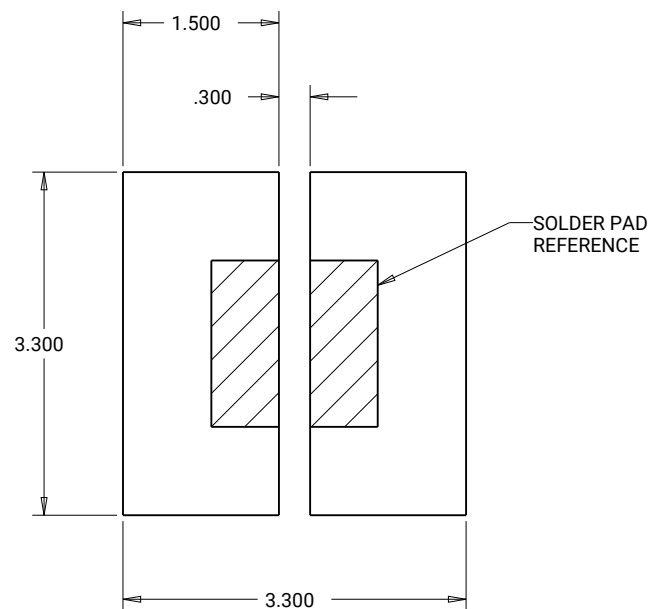

**Recommended trace layout**



**PRELIMINARY**

**TAPE AND REEL**

All Cree carrier tapes conform to EIA-481D, Automated Component Handling Systems Standard.

Except as noted, all dimensions in mm.

Measurement tolerances unless indicated otherwise: .xx = ±.25 mm, .xxx = . ± 125 mm

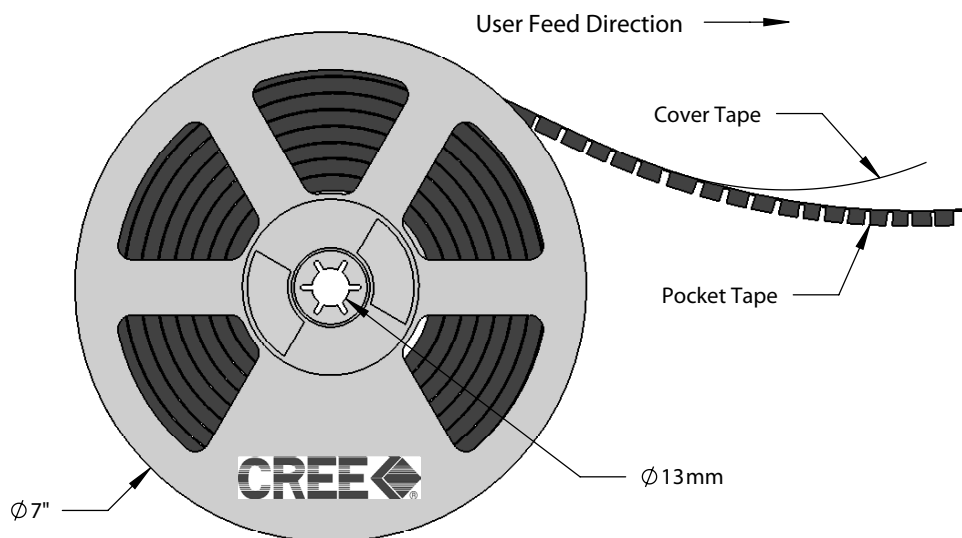
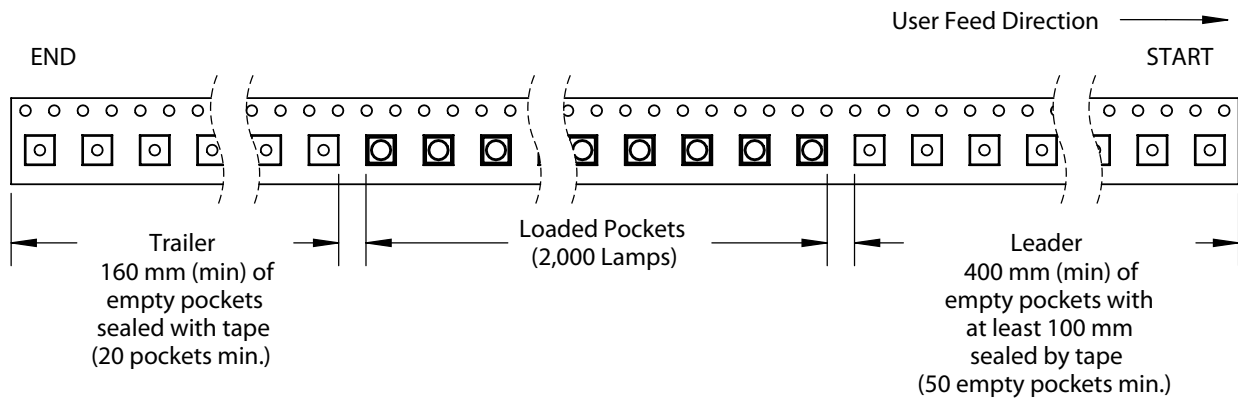
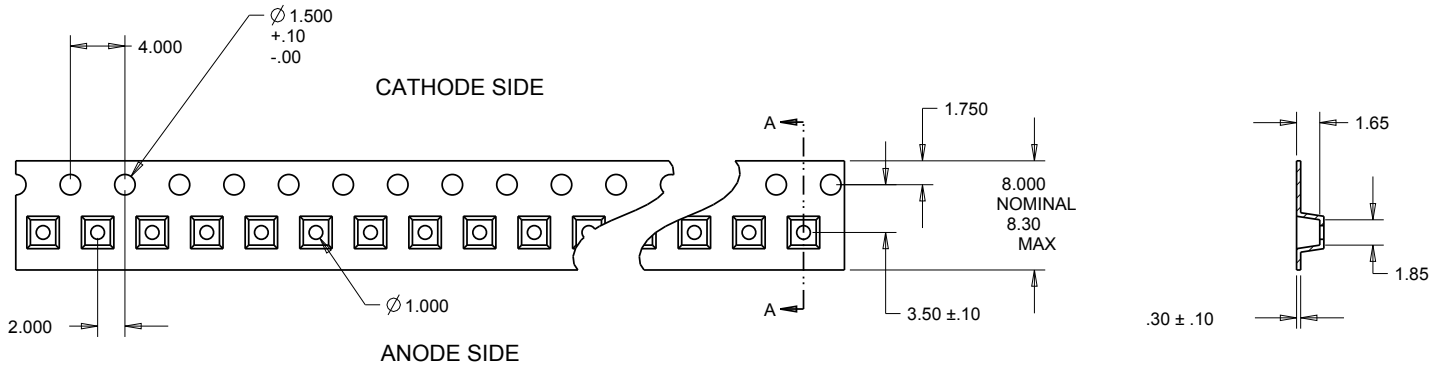

## PRELIMINARY

### PACKAGING

The diagrams below show the packaging and labels Cree uses to ship XLamp XQ-A LEDs. XLamp XQ-A LEDs are shipped in tape loaded on a reel. Each box contains only one reel in a moisture barrier bag.

#### Unpackaged Reel

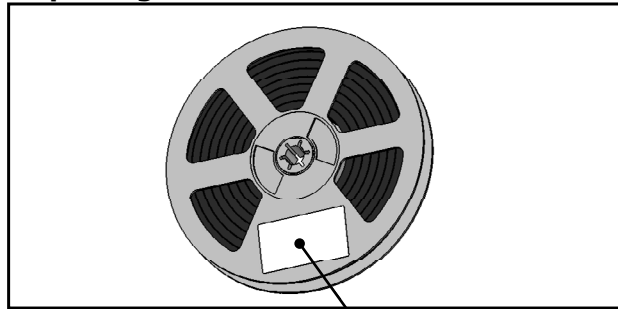

Label with Cree Bin Code, Quantity, Reel ID

#### Packaged Reel

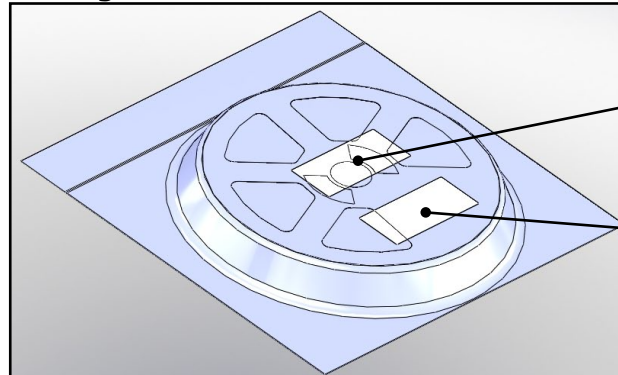

Label with Cree Order Code, Quantity, Reel ID, PO #

Label with Cree Bin Code, Quantity, Reel ID

#### Boxed Reel

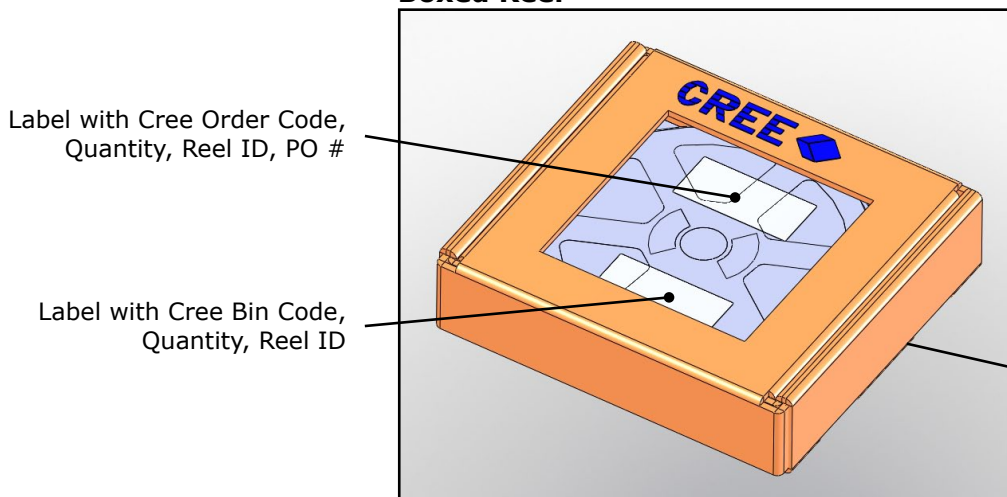

Label with Cree Order Code, Quantity, Reel ID, PO #

Label with Cree Bin Code, Quantity, Reel ID

Patent Label (on bottom of box)

## Данный компонент на территории Российской Федерации

### Вы можете приобрести в компании MosChip.

Для оперативного оформления запроса Вам необходимо перейти по данной ссылке:

<http://moschip.ru/get-element>

Вы можете разместить у нас заказ для любого Вашего проекта, будь то серийное производство или разработка единичного прибора.

В нашем ассортименте представлены ведущие мировые производители активных и пассивных электронных компонентов.

Нашей специализацией является поставка электронной компонентной базы двойного назначения, продукции таких производителей как XILINX, Intel (ex.ALTERA), Vicor, Microchip, Texas Instruments, Analog Devices, Mini-Circuits, Amphenol, Glenair.

Сотрудничество с глобальными дистрибьюторами электронных компонентов, предоставляет возможность заказывать и получать с международных складов практически любой перечень компонентов в оптимальные для Вас сроки.

На всех этапах разработки и производства наши партнеры могут получить квалифицированную поддержку опытных инженеров.

Система менеджмента качества компании отвечает требованиям в соответствии с ГОСТ Р ИСО 9001, ГОСТ РВ 0015-002 и ЭС РД 009

### Офис по работе с юридическими лицами:

105318, г.Москва, ул.Щербаковская д.3, офис 1107, 1118, ДЦ «Щербаковский»

Телефон: +7 495 668-12-70 (многоканальный)

Факс: +7 495 668-12-70 (доб.304)

E-mail: [info@moschip.ru](mailto:info@moschip.ru)

Skype отдела продаж:

moschip.ru

moschip.ru\_4

moschip.ru\_6

moschip.ru\_9