

1/3, 1/4 Duty LCD Driver

■ GENERAL DESCRIPTION

NJU6533 is a 1/3 or 1/4 duty segment type LCD driver. It incorporates 4 common driver circuits and 32 segment driver circuits. **NJU6533** can drive maximum 96 segments in 1/3 duty ratio and maximum 128 segments in 1/4 duty ratio. In addition, the **NJU6533's** useful functions and small package meet a wide range of applications.

■ PACKAGE OUTLINE

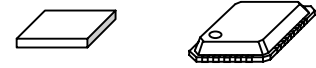

NJU6533C **NJU6533KQ1**

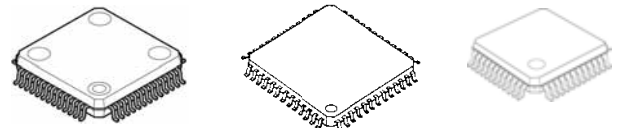

NJU6533FA2 **NJU6533FH2** **NJU6533FR3**

■ FEATURES

- LCD driving circuit :Max. 32outputs (4 outputs as for general purpose ports)
- Programmable Duty Ratio
 - 1/3 duty ratio :Driving max. 96 segments
 - 1/4 duty ratio :Driving max. 128 segments
- Programmable Bias Ratio :1/2, 1/3 bias ratio
- Serial Data Transfer :Shift clock max. 2MHz
- Built-in Oscillator :CR oscillation with external resistor, or external oscillation signal input
- Display OFF :INHb terminal
- Operating Voltage :3V / 5.0V
- C-MOS Technology :P-Sub
- Package Outline :Bare Chip, QFN48-Q1, QFP52-A2, LQFP52-H2, LQFP48-R3

■ BLOCK DIAGRAM

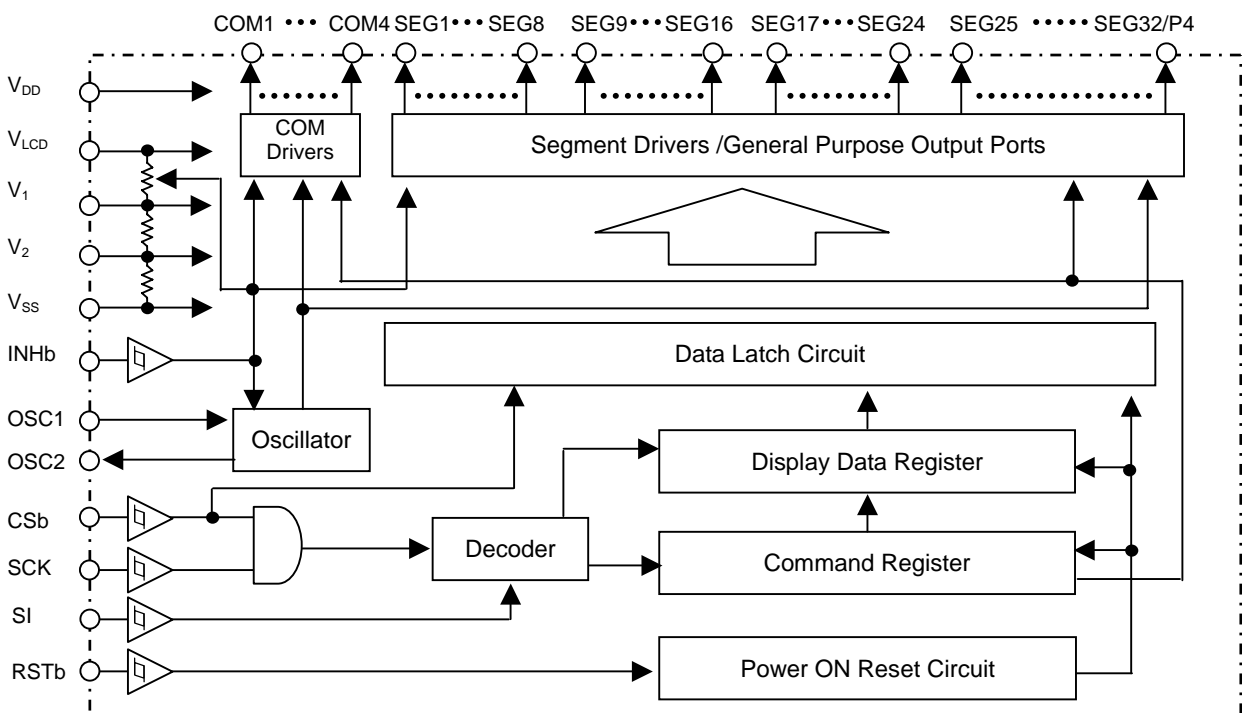

■ PAD LOCATION

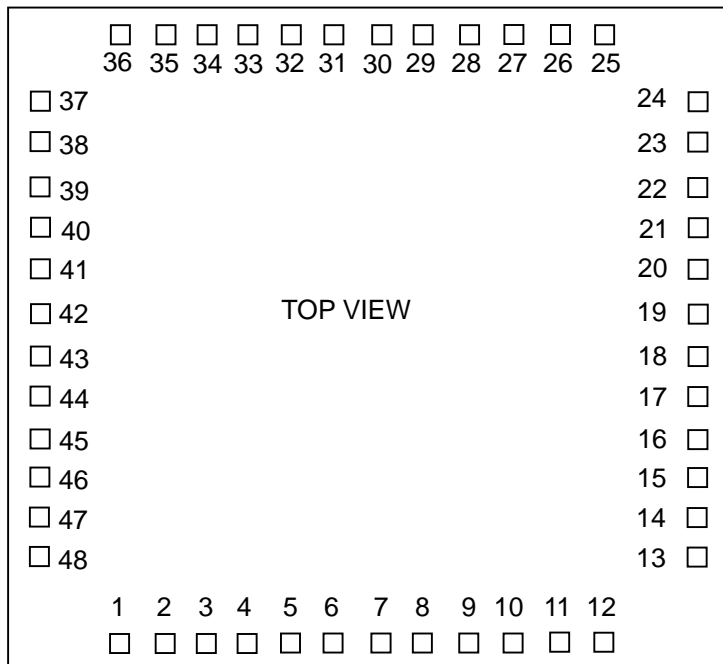

Chip Center : X=0 μ m, Y=0 μ m
 Chip Size : X= 2.60 mm, Y= 2.36 mm
 Chip Thickness : 625 μ m \pm 25 μ m
 PAD Size : 90.0 μ m x 90.0 μ m
 PAD Pitch : 126 μ m
 Sub Striate : P

■ PAD COORDINATES

Chip Size 2.60 x 2.36 mm(Chip Center X=0 μ m, Y=0 μ m)

PAD No.	PAD NAME	X= μ m	Y= μ m
1	COM1	-686	-1019
2	COM2	-560	-1019
3	COM3	-434	-1019
4	COM4	-308	-1019
5	SEG1	-182	-1019
6	SEG2	-56	-1019
7	SEG3	70	-1019
8	SEG4	196	-1019
9	SEG5	322	-1019
10	SEG6	448	-1019
11	SEG7	574	-1019
12	SEG8	700	-1019
13	SEG9	1138	-739
14	SEG10	1138	-613
15	SEG11	1138	-487
16	SEG12	1138	-361
17	SEG13	1138	-235
18	SEG14	1138	-109
19	SEG15	1138	17
20	SEG16	1138	143
21	SEG17	1138	269
22	SEG18	1138	395
23	SEG19	1138	521
24	SEG20	1138	647

PAD No.	PAD NAME	X= μ m	Y= μ m
25	SEG21	784	1019
26	SEG22	658	1019
27	SEG23	532	1019
28	SEG24	406	1019
29	SEG25	280	1019
30	SEG26	154	1019
31	SEG27	28	1019
32	SEG28	-98	1019
33	SEG29/P1	-356	1019
34	SEG30/P2	-482	1019
35	SEG31/P3	-837	1019
36	SEG32/P4	-963	1019
37	V _{LCD}	-1138	914
38	V ₁	-1138	790
39	V ₂	-1138	557
40	V _{SS}	-1138	432
41	INHb	-1138	236
42	RSTb	-1138	112
43	CSb	-1138	-121
44	SI	-1138	-245
45	SCK	-1138	-479
46	V _{DD}	-1138	-603
47	OSC1	-1138	-845
48	OSC2	-1138	-971

■ PIN CONFIGURATION

• QFN48-Q1 / LQFP48-R3

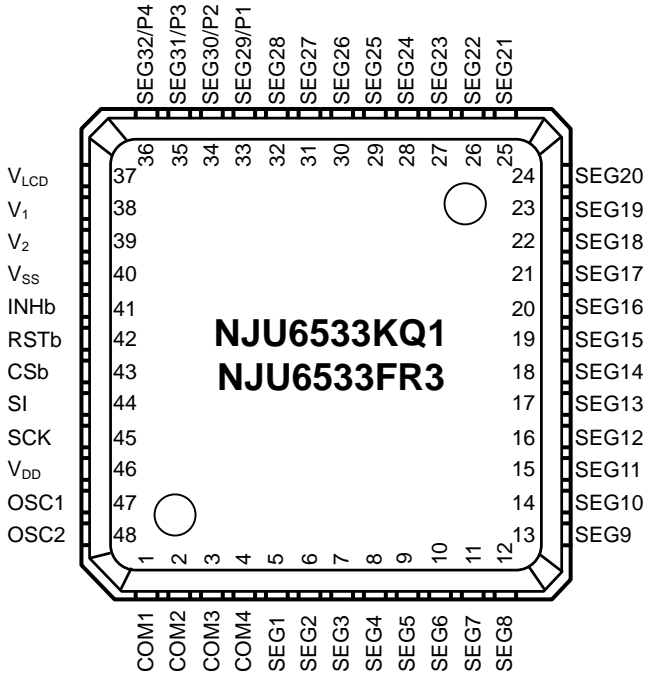

• QFP52-A2 / LQFP52-H2

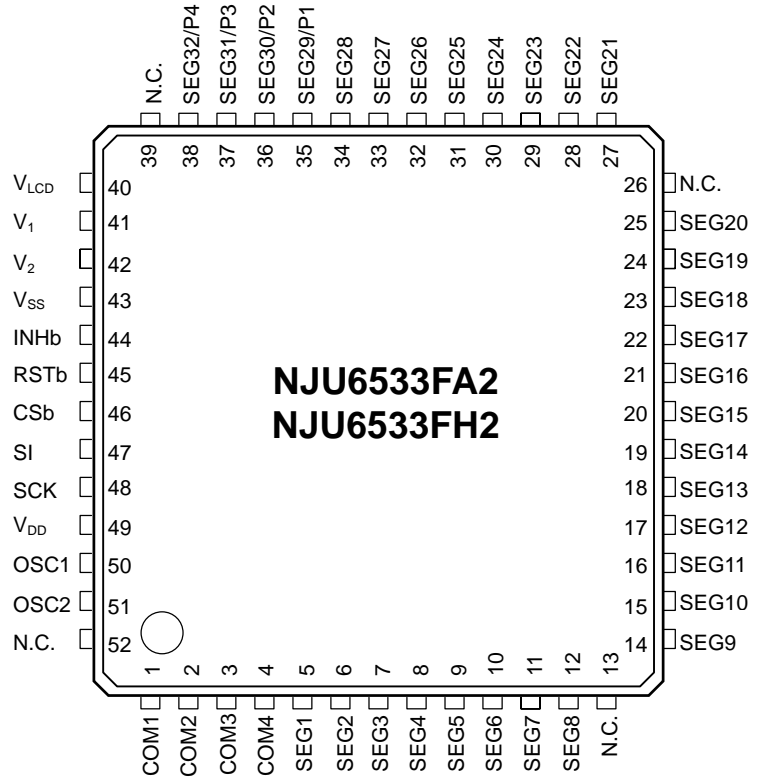

■ TERMINAL DISCRIPTION

Bare Chip	No.		Pad Name	Function
	QFN48-Q1 LQFP48-R3	QFP52-A2 LQFP52-H2		
46	46	49	V _{DD}	● Power supply: 3V /5V
37	37	40	V _{LCD}	LCD driving voltage $V_{LCD} \geq V_1 \geq V_2 \geq V_{SS}$, $V_{LCD} \geq V_{DD}$
38, 39	38, 39	41, 42	V ₁ , V ₂	Bias At 1/3 bias ratio, keep V ₁ - V ₂ open. At 1/2 bias ratio, short V ₁ - V ₂ .
40	40	43	V _{SS}	GND V _{SS} =0V
41	41	44	INHb	Display OFF * When INHb is "H", display is ON, and when INHb is "L", display is off. When SEG29(P1)~SEG32 (P4) are selected as general purpose output ports, even if input "0" to INHb terminal, SEG29~32 will still be recognized as general purpose output ports.
42	42	45	RSTb	Reset When RSTb is "L", command register and latch circuit is reset.
43	43	46	CSb	Chip select When CSb is "L", data can be read in.
44	44	47	SI	Serial data input (8 bit=1 word)
45	45	48	SCK	Serial clock
47, 48	47, 48	50, 51	OSC1, OSC2	External resistor connection terminal for CR oscillation, or external clock input terminal When external clock is used, input the signal to OSC1 and keep OSC2 open.
1~4	1~4	1~4	COM1 ~ COM4	Common driver outputs
5~32	5~32	5~12, 14~25, 27~34	SEG1 ~ SEG28	Segment driver outputs
33~36	33~36	35~39	SEG29/P1~ SEG32/P4	Segment driver outputs/general purpose output ports These 4 terminals can be used as segment outputs or general purpose output ports by setting Command Register. When selected as general purpose ports, data can be outputted via these ports during COM1 timing. According to transferred data, "H"=V _{DD} or "L"=V _{SS} will be outputted.
-	-	13,26, 39,52	NC	Non Connection These pins must be open.

*: For details about INHb, please refer to "■ FUNCTION DESCRIPTION (5) Display OFF function (INHb terminal)".

■ FUNCTION DESCRIPTION

(1) Block Function

- Oscillator
The oscillator includes a built-in capacitor and an external resistor. It generates clock signal for LCD driving. When use external clock, input the clock signal to OSC1 and keep OSC2 open.
- Decoder
Input serial data is decoded and sent to the appropriate block.
- Command Register
Command data is written to this 8 bits command register to control **NJU6533** operation.
- Display Data Register
Data is written to this 8 bits register as display data.
- Latch Circuit
Data stored in display data register is assigned to the corresponding SEG/port.
- Segment Driver/General Purpose Ports
Basing on display data, segment drivers output LCD SEG driving signal.
And, SEG29/P1 ~ SEG32/P4 terminals can be selected as segment driver output or general-purpose ports by instruction.
- Common Driver
Common drivers output LCD COM driving signal.
- Power On Reset
When power is on, **NJU6533** is automatically initialized. And if RSTb="L", **NJU6533** is reset too.

(2) Serial Data Transfer

The transfer of an 8-bit/word serial data is conducted by synchronizing clock via interface with CPU. During CSb="L", serial data is obtainable and will be read in at the rising edge of SCK signal.

After CSb becoming low, if the first word is address data, the after data can be transferred continually and interrupted as display data even if CSb maintained low. In this case, every 8 bits data will be confirmed as a word either by the falling edge of the 8th SCK clock or by the rising edge of the CSb clock.

After CSb becoming low, if the first word is command data, the after data is invalid even though transfer can be continued without changing the polarity of CSb.

At the falling edge of CSb, SCK can be either "H" or "L", but, at the rising edge of CSb, SCK must be low.

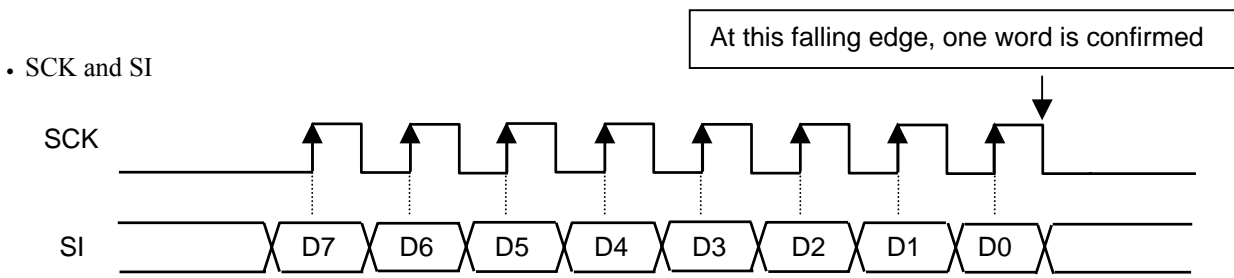

Timing of Serial Data Transfer

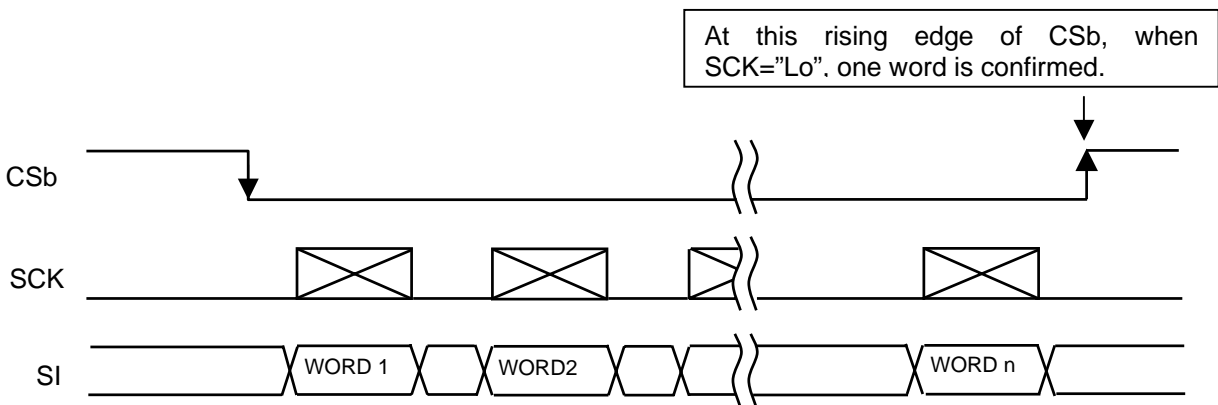

Serial Interface Format

(3) Command Register

Command Register is used to set the duty ratio, the bias ratio, and the SEG driver/general purpose ports. When the D7 to D5 bits of the 1st word are (1,0,0), the D4 ~ D0 bits are recognized as command data.

The contents of Command Register will be initialized as following when applying Power On Reset or Reset.

The Default Value of Command Register

- Duty ratio : 1/4
- Bias ratio : 1/3
- SEG driver/General purpose ports : SEG drivers(SEG29, SEG30, SEG31, SEG32)

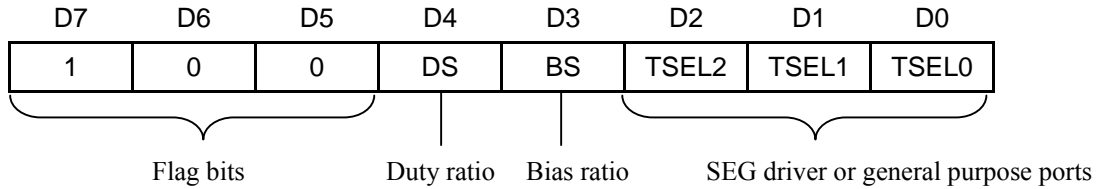

• Duty Ratio

DS	Duty ratio
0	1/4
1	1/3

*) Do not change the duty ratio during display ON.

• Bias ratio

BS	Bias ratio
0	1/3
1	1/2

• SEG driver or general purpose ports

TSEL2	TSEL1	TSEL0	SEG29/P1	SEG30/P2	SEG31/P3	SEG32/P4
0	0	0	SEG29	SEG30	SEG31	SEG32
0	0	1	SEG29	SEG30	SEG31	P4
0	1	0	SEG29	SEG30	P3	P4
0	1	1	SEG29	P2	P3	P4
1	0	0	P1	P2	P3	P4

***) If TSEL2 ~ TSEL0 is set to (1, 0, 1), (1, 1, 0), (1, 1, 1) all outputs are used as segment drivers.

(4) Output Address Counter

Output Address Counter will specify the addresses of the SEG and COM drivers for the display data.

When the MSB (D7 to D4) of the 1st data is "0111", the LSB 4 bits (D3 to D0) specify the addresses of COM and SEG drivers, and the 2nd data is the display data which will be sent to the 1st-data-specified drivers. At the same time, SEG and COM driver addresses will be increased automatically in turn as shown in **Table 1**. In other words, as of the SEG and COM driver addresses specified by the first data in the Output Address Counter, display data can be transferred to the SEG and COM drivers without further address setting.

The address setting range is from "0000" to "1111", if transfer data outnumber the address number which are from D3 ~ D0 to "1111", the SEG and COM driver address will be reset to "0000" and renew the auto-increment operation.

• Address Data

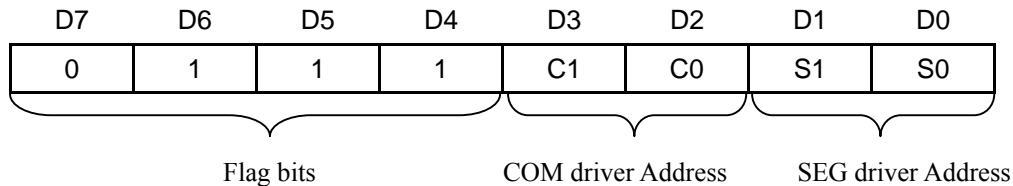

Table 1. The Relationship Between Output Address and SEG/COM Drivers

Increment Direction	C1	C0	S1	S0	COM Driver	SEG Driver							
						D7	D6	D5	D4	D3	D2	D1	D0
						SEG1	SEG2	SEG3	SEG4	SEG5	SEG6	SEG7	SEG8
↓	0	0	0	0	COM1	SEG1	SEG2	SEG3	SEG4	SEG5	SEG6	SEG7	SEG8
						SEG9	SEG10	SEG11	SEG12	SEG13	SEG14	SEG15	SEG16
						SEG17	SEG18	SEG19	SEG20	SEG21	SEG22	SEG23	SEG24
						SEG25	SEG26	SEG27	SEG28	SEG29	SEG30	SEG31	SEG32
↓	0	1	0	0	COM2	SEG1	SEG2	SEG3	SEG4	SEG5	SEG6	SEG7	SEG8
						SEG9	SEG10	SEG11	SEG12	SEG13	SEG14	SEG15	SEG16
						SEG17	SEG18	SEG19	SEG20	SEG21	SEG22	SEG23	SEG24
						SEG25	SEG26	SEG27	SEG28	SEG29	SEG30	SEG31	SEG32
↓	1	0	0	0	COM3	SEG1	SEG2	SEG3	SEG4	SEG5	SEG6	SEG7	SEG8
						SEG9	SEG10	SEG11	SEG12	SEG13	SEG14	SEG15	SEG16
						SEG17	SEG18	SEG19	SEG20	SEG21	SEG22	SEG23	SEG24
						SEG25	SEG26	SEG27	SEG28	SEG29	SEG30	SEG31	SEG32
↓	1	1	0	0	COM4	SEG1	SEG2	SEG3	SEG4	SEG5	SEG6	SEG7	SEG8
						SEG9	SEG10	SEG11	SEG12	SEG13	SEG14	SEG15	SEG16
						SEG17	SEG18	SEG19	SEG20	SEG21	SEG22	SEG23	SEG24
						SEG25	SEG26	SEG27	SEG28	SEG29	SEG30	SEG31	SEG32

- ✧ If general purpose ports are selected by Command Register, under (C1, C0, S1, S0)=(0, 0, 1, 1), D3 ~ D0 bits are the addresses of (P1, P2, P3, P4) ports which corresponds to (SEG29, SEG30, SEG31, SEG32).
- ✧ When SEG29~SEG32 are set as general purpose output ports, data for SEG29~SEG32 during COM2~COM4 scanning will be ignored.
- ✧ When duty ratio is 1/3, do not set address between "1100"~"1111". Otherwise, unexpected address way be setup.

(5) Display OFF Function (INHb)

When INHb="L"

- All segment and common terminal output V_{SS}
(When general purpose output ports are selected, even INHb="L", these ports can output data)
- Suspending Oscillation (but, if RSTb="L", oscillator works)
- V_1 and V_2 become "H" (no current pass through the bleeder resistors)

Even during INHb="L", interface can be accessed, and data can be written into the command register, address counter and data register.

(6) Power ON Reset

After power ON, **NJU6533** is initialized to the following values:

- Address counter (C1, C0, S1, S0)=(0, 0, 0, 0)
- Display Data Register all "0"
- Duty ratio 1/4duty
- Bias ratio 1/3 bias
- Segment/General purpose port: Segment output(SEG29, SEG30, SEG31, SEG32)

(7) Sequence of Initialization

(7-1) 1/3duty, SEG32 used as general purpose port, data written in from COM2.

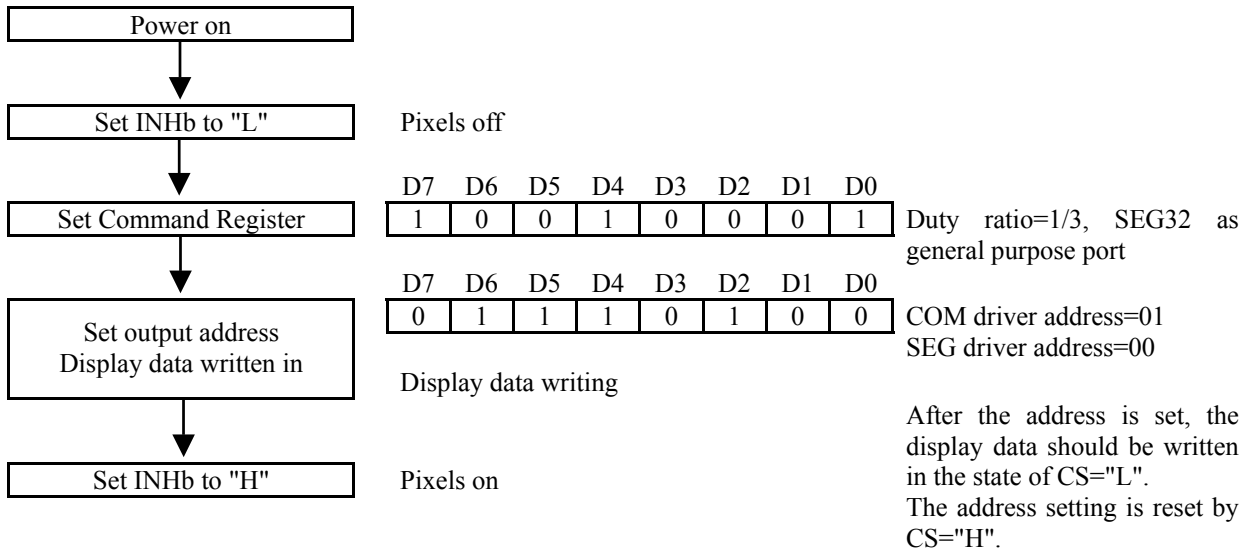

(7-2) 1/4duty, SEG29 ~ 32 used as SEG drivers, data written in from COM1.

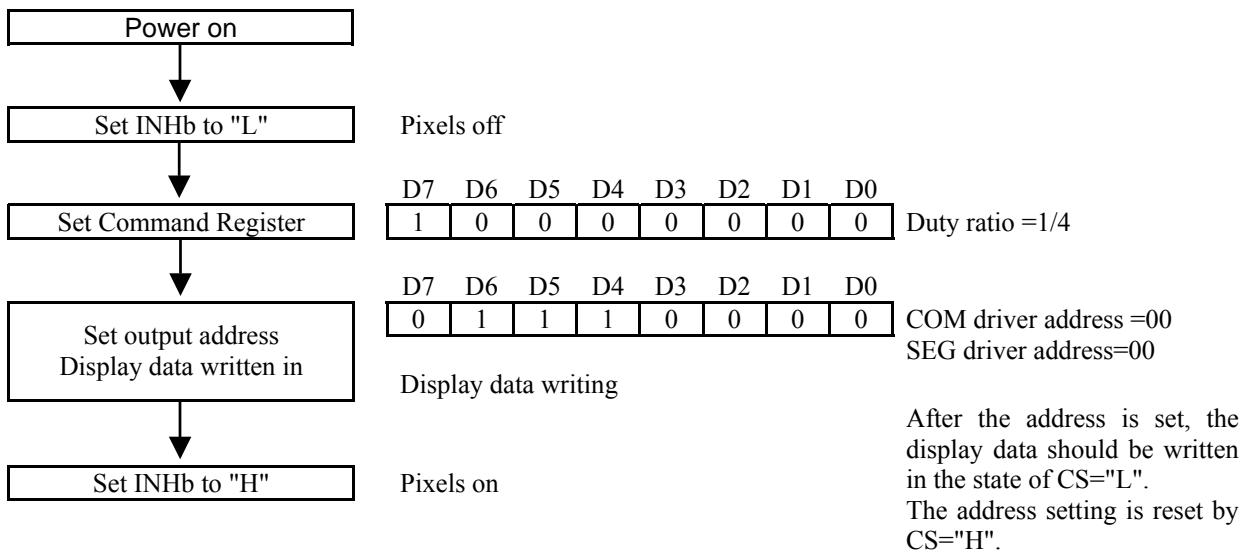

■ ABSOLUTE MAXIMAM RATINGS

($V_{SS}=0V$, $T_a=25^{\circ}C$)

PARAMETER	SYMBOL	RATINGS	UNIT	CONDITIONS
Supply Voltage 1	V_{DD}	-0.3 ~ +6.0	V	
Supply Voltage 2	V_{LCD}	-0.3 ~ +6.0	V	
Supply Voltage 3	V_1, V_2	-0.3 ~ $V_{LCD}+0.3$	V	
Input Voltage	V_{IN}	-0.3 ~ $V_{DD}+0.3$	V	INHb, CSb, SCK, SI, RSTb, OSC1 applicable.
Operating Temp.	T_{opr}	-40 ~ +85	$^{\circ}C$	
Storage Temp.	T_{stg}	-55 ~ +125	$^{\circ}C$	
Dissipation Power	P_D	710(QFN48-Q1) 900(QFP52-A2) 890(LQFP52-H2) 1000(LQFP48-R3)	mW	The power dissipation is value mounted on a glass epoxy board in size: 50mm x50mm x1.6mm(QFN48-Q1), 76.2mm x114.3mm x1.6mm (QFP52-A2, LQFP52-H2, LQFP48-R3).

Note-1) Do not exceed the absolute maximum ratings, otherwise the stress may cause a permanent damage to the IC. It is also recommended that the IC be used within the range specified in the DC electrical characteristics, or the electrical stress may cause mulfuctions and impact on the reliability.

Note-2) All voltages are relative to $V_{SS}=0V$ reference.

Note-3) The following relationship shall be maintained.

$$V_{LCD} \geq V_1 \geq V_2 \geq V_{SS}, V_{LCD} \geq V_{DD}, \text{ and } V_{LCD} \text{ shall be input after } V_{DD}.$$

Note-4) To stabilize the LSI operation, place decoupling capacitors between $V_{DD}-V_{SS}$ and between $V_{LCD}-V_{SS}$.

■ ELECTRICAL CHARACTERISTICS

• DC characteristics 1

($V_{DD}=2.4$ to $3.6V$, $V_{SS}=0V$, $T_a=-40$ to $85^{\circ}C$)

PARAMETER	SYMBOL	CONDITIONS	MIN	TYP	MAX	UNIT	Note
Power Supply	V_{DD}		2.4		3.6	V	
LCD Driving Voltage	V_{LCD}	$V_{LCD} \geq V_{DD}$	2.4		5.5	V	
LCD Bias Voltage	V_1	$T_a=25^{\circ}C$ Testing via COM/SEG terminals COM/SEG without load	$2/3 V_{LCD}-0.2$	$2/3 V_{LCD}$	$2/3 V_{LCD}+0.2$	V	
	V_2		$1/3 V_{LCD}-0.2$	$1/3 V_{LCD}$	$1/3 V_{LCD}+0.2$	V	
"H" Level Input Voltage	V_{IH}	INHb, CSb, SCK, SI, RESb, OSC1	$0.8 V_{DD}$		V_{DD}	V	
"L" Level Input Voltage	V_{IL}	INHb, CSb, SCK, SI, RESb, OSC1	0		$0.2 V_{DD}$	V	
Hysteresis Voltage	V_H	INHb, CSb, SCK, SI, RESb		$0.2V_{DD}$		V	
"H" Level Input Current	I_{IH}	$V_{IN}=V_{DD}$ INHb, CSb, SCK, SI, RESb			1.0	μA	
"L" Level Input Current	I_{IL}	$V_{IN}=V_{SS}$ INHb, CSb, SCK, SI, RESb			1.0	μA	
"H" Level Output Voltage	V_{OH}	$V_{DD}=3V$, $I_o=5mA$, P1 to P4	$V_{DD}-0.6$			V	
"L" Level Output Voltage	V_{OL}	$V_{DD}=3V$, $I_o=5mA$, P1 to P4			0.6	V	
Driver-on Resistance (COM)	R_{COM}	$\pm I_d=1\mu A$, $V_{LCD}=3V/5.5V$	-	-	10	$k\Omega$	5
Driver-on Resistance (SEG)	R_{SEG}	$\pm I_d=1\mu A$, $V_{LCD}=3V/5.5V$	-	-	10	$k\Omega$	5
Oscillating Frequency	f_{OSC}	$V_{DD}=3V$, $R_{OSC}=750k\Omega$, $T_a=25^{\circ}C$	12.6	15.4	18.2	kHz	
External Clock Frequency	f_{CP}	Input into OSC1	12.6	15.4	18.2	kHz	
External Clock Duty	duty	Input into OSC1	45	50	55	%	
Bleeder Resistor	R_B	$V_{LCD}-V_{SS}$ $T_a=25^{\circ}C$	127	150	173	$k\Omega$	
Operating Current	I_{DD1}	$V_{DD}=3V$, INHb="L", RSTb="H", $T_a=25^{\circ}C$		1.7	8.0	μA	
	I_{DD2}	$V_{DD}=3V$, $V_{LCD}=5V$, $T_a=25^{\circ}C$, Checker flag display, 1/3 bias Using internal oscillator, no output		7.0	25	μA	
	I_{LCD1}	$V_{DD}=3V$, $V_{LCD}=5V$, RSTb="H", INHb="L", $T_a=25^{\circ}C$		0.1	1.0	μA	
	I_{LCD2}	$V_{DD}=3V$, $V_{LCD}=5V$, $T_a=25^{\circ}C$, Checker flag display, 1/3 bias Using internal oscillator, no output		34	60	μA	

Note-5) Driver-On resistance (R_{SEG}/R_{COM}) is measured from V_{LCD} , V_{SS} , V_1 or V_2 terminal to each SEG/COM terminal when I_d current flows through COM/SEG terminals.

Note-6) ["H" Level Input Voltage], ["L" Level Input Voltage], [Hysteresis Voltage], ["H" Level Input Current], ["L" Level Input Current], [External Clock Frequency] and [External Clock Duty] are as the same as if $V_{DD}=4.5$ to $5.5V$.

• DC characteristics 2

($V_{DD}=4.5$ to $5.5V$, $V_{SS}=0V$, $T_a=-40$ to $85^{\circ}C$)

PARAMETER	SYMBOL	CONDITIONS	MIN	TYP	MAX	UNIT	Note
Power Supply	V_{DD}		4.5		5.5	V	
LCD Driving Voltage	V_{LCD}	$V_{LCD} \geq V_{DD}$	4.5		5.5	V	
LCD Bias Voltage	V_1	Ta=25°C Testing via COM/SEG terminals COM/SEG without load	2/3 $V_{LCD}-0.2$	2/3 V_{LCD}	2/3 $V_{LCD}+0.2$	V	
	V_2		1/3 $V_{LCD}-0.2$	1/3 V_{LCD}	2/3 $V_{LCD}+0.2$	V	
"H" Level Input Voltage	V_{IH}	INHb, CSb, SCK, SI, RESb, OSC1	0.8 V_{DD}		V_{DD}	V	
"L" Level Input Voltage	V_{IL}	INHb, CSb, SCK, SI, RESb, OSC1	0		0.2 V_{DD}	V	
Hysteresis Voltage	V_H	INHb, CSb, SCK, SI, RESb		0.2 V_{DD}		V	
"H" Level Input Current	I_{IH}	$V_{IN}=V_{DD}$ INHb, CSb, SCK, SI, RESb			1.0	μA	
"L" Level Input Current	I_{IL}	$V_{IN}=V_{SS}$ INHb, CSb, SCK, SI, RESb			1.0	μA	
"H" Level Output Voltage	V_{OH}	$V_{DD}=5V$, $I_O=5mA$, P1 to P4	$V_{DD}-1.0$			V	
"L" Level Output Voltage	V_{OL}	$V_{DD}=5V$, $I_O=5mA$, P1 to P4			1.0	V	
Driver-on Resistance (COM)	R_{COM}	$\pm I_d=1\mu A$, $V_{LCD}=3V/5.5V$	-	-	10	k Ω	7
Driver-on Resistance (SEG)	R_{SEG}	$\pm I_d=1\mu A$, $V_{LCD}=3V/5.5V$	-	-	10	k Ω	7
Oscillating Frequency	f_{OSC}	$V_{DD}=5V$, $R_{OSC}=750k\Omega$, $T_a=25^{\circ}C$	12.6	15.4	18.2	kHz	
External Clock Frequency	f_{CP}	Input into OSC1	12.6	15.4	18.2	kHz	
External Clock Duty	duty	Input into OSC1	45	50	55	%	
Bleeder Resistor	R_B	$V_{LCD}-V_{SS}$, $T_a=25^{\circ}C$	127	150	173	k Ω	
Operating Current	I_{DD1}	$V_{DD}=5V$, INHb="L", RSTb="H", $T_a=25^{\circ}C$		3.2	10	μA	
	I_{DD2}	$V_{DD}=5V$, $V_{LCD}=5V$, $T_a=25^{\circ}C$, Checker flag display, 1/3 bias Using internal oscillator, no output		15	35	μA	
	I_{LCD1}	$V_{DD}=5V$, $V_{LCD}=5V$, INHb="L", RSTb="H", $T_a=25^{\circ}C$		0.1	1.0	μA	
	I_{LCD2}	$V_{DD}=5V$, $V_{LCD}=5V$, $T_a=25^{\circ}C$, Checker flag display, 1/3 bias Using internal oscillator, no output		34	60	μA	

Note-7) Driver-On resistance (R_{SEG}/R_{COM}) is measured from V_{LCD} , V_{SS} , V_1 or V_2 terminal to each SEG/COM terminal when I_d current flows through COM/SEG terminals.

Note-8) ["H" Level Input Voltage], ["L" Level Input Voltage], [Hysteresis Voltage], ["H" Level Input Current], ["L" Level Input Current], [External Clock Frequency] and [External Clock Duty] are as the same as if $V_{DD}=2.4$ to $3.6V$.

• AC characteristics

($V_{DD}=V_{LCD}=2.4$ to $5.5V$, $V_{SS}=0V$, $T_a=-40$ to $85^{\circ}C$)

PARAMETER	SYMBOL	CONDITIONS	MIN	TYP	MAX	UNIT	Note
"L" Level Clock Pulse Width	t_{WCLL}		230			ns	
"H" Level Clock Pulse Width	t_{WCLH}		230			ns	
Data Setup Time	t_{DS}		20			ns	
Data Hold Time	t_{DH}		20			ns	
CSb Wait Time	t_{CP}		50			ns	9
CSb Setup Time	t_{CS}		50			ns	
CSb Hold Time	t_{CH}		50			ns	
CSb"H" Level Pulse Width	t_{WCH}		50			ns	
Rising Time	t_r				20	ns	
Falling Time	t_f				20	ns	

Note-9) t_{CP} is the time when SCK is kept at "H" during CSb changed from "H" to "L".

• Input Timing

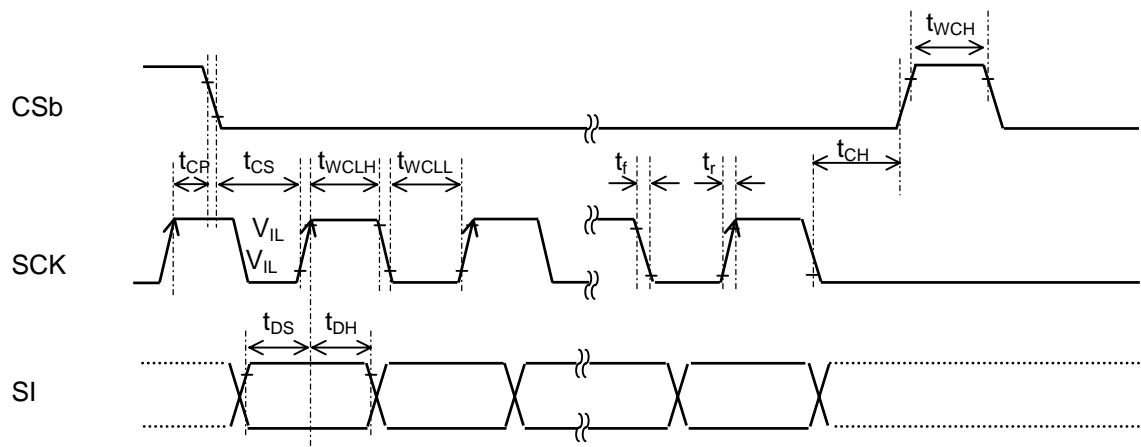

• Input condition when hardware reset circuit is used

($T_a=25^{\circ}C$)

PARAMETER	SYMBOL	CONDITIONS	MIN	TYP	MAX	UNIT
Reset Input "L" Level Width	t_{RSL}	$f_{OSC}=15.4kHz$	1.5			ms
Reset Rising Time	t_{RFS}				100	ns
Reset Falling Time	t_{RFS}				100	ns

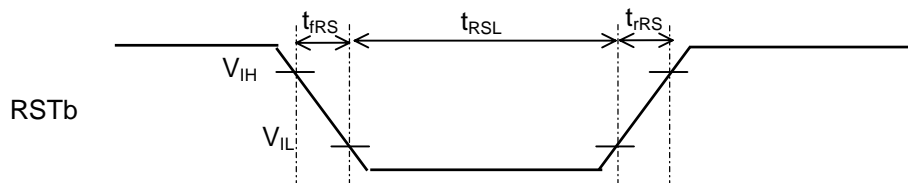

• Power supply condition when hardware reset circuit is used

($T_a=-40$ to $85^{\circ}C$)

PARAMETER	SYMBOL	CONDITIONS	MIN	TYP	MAX	UNIT
Power-on Rising Time	t_{rDD}		0.1		5	ms
Power-off Time	t_{OFF}		1			ms

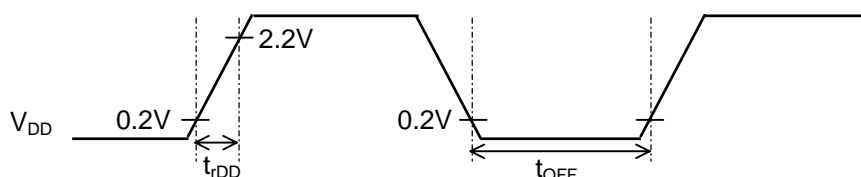

Note 10) t_{OFF} is the off time when power-supply turns off suddenly or cycles on/off.

■ EXAMPLE of SERIAL DATA TRANSFER

- Command Register Set

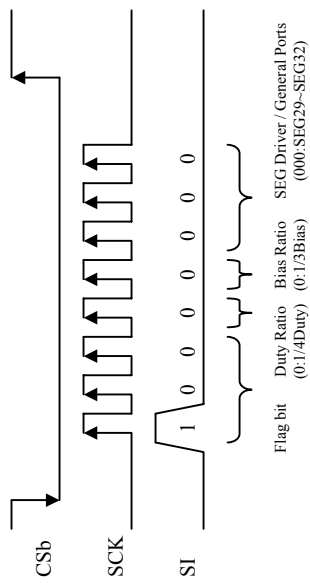

- Address Data & Display Data Set (example : all "1" data writing)

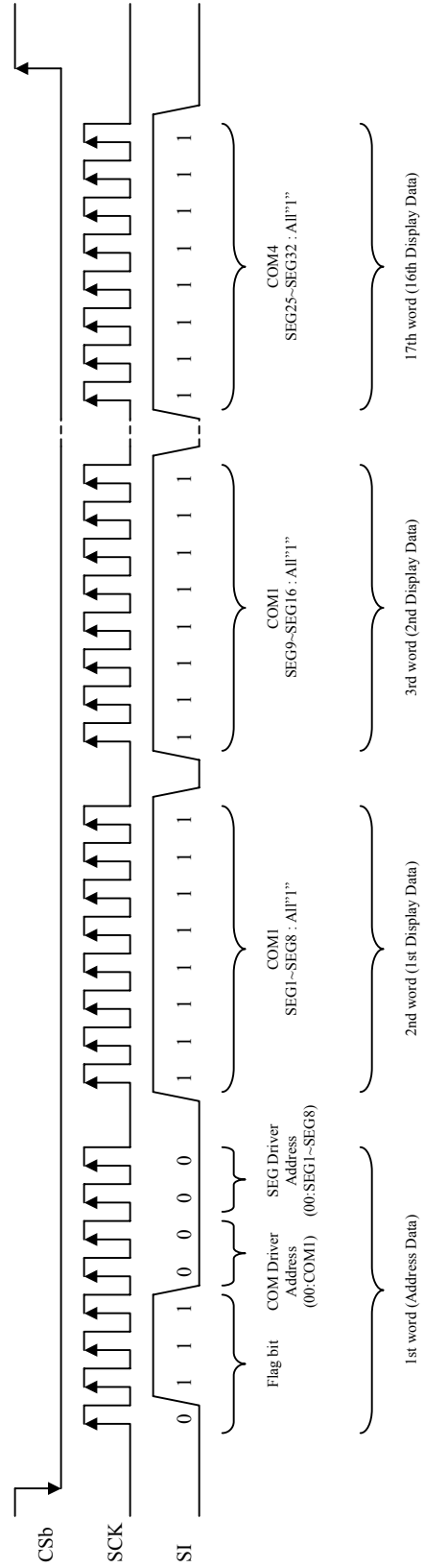

■ LCD DRIVING WAVEFORM

(a) 1/3 duty, 1/2 bias

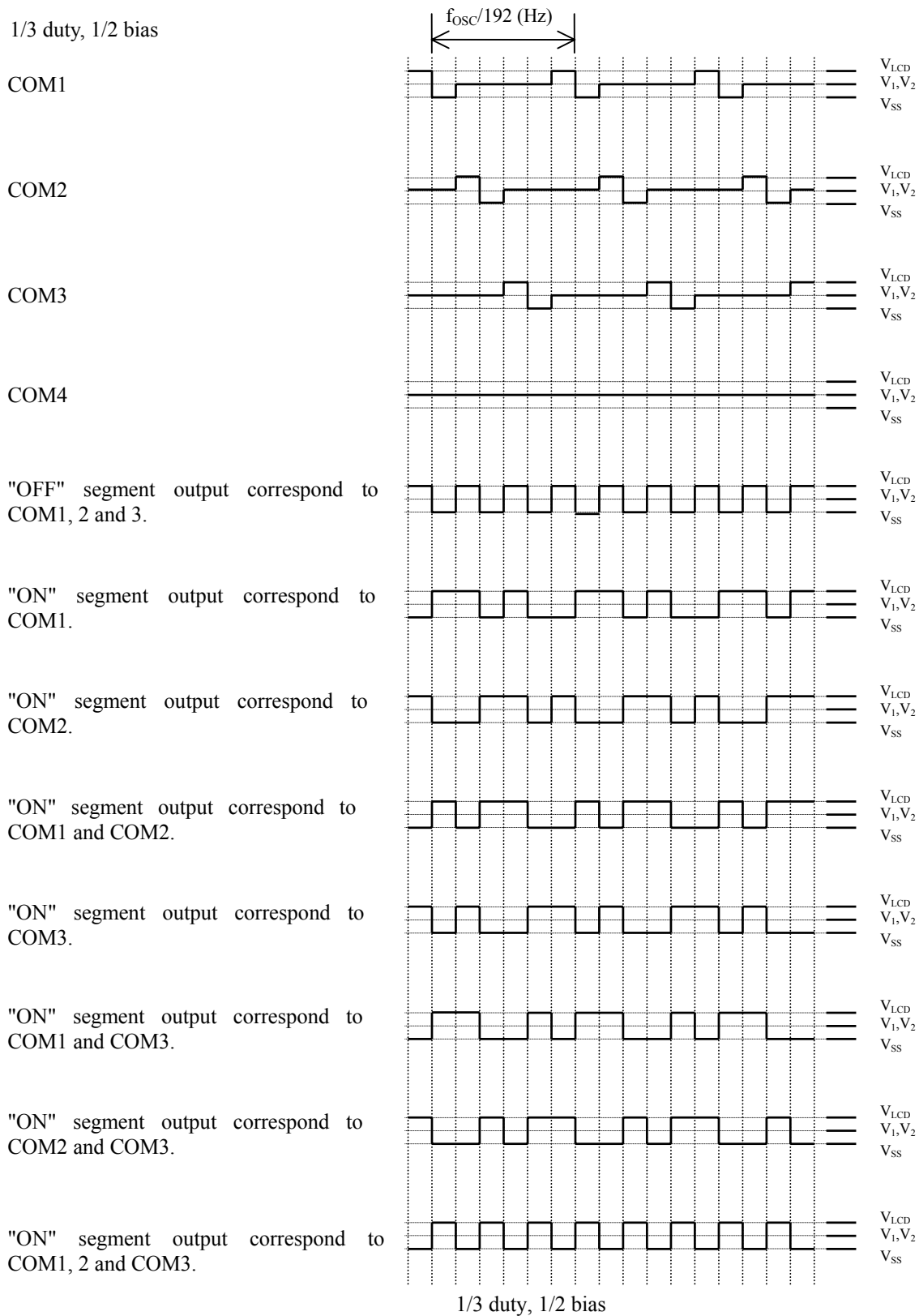

(b) 1/3 duty, 1/3 bias

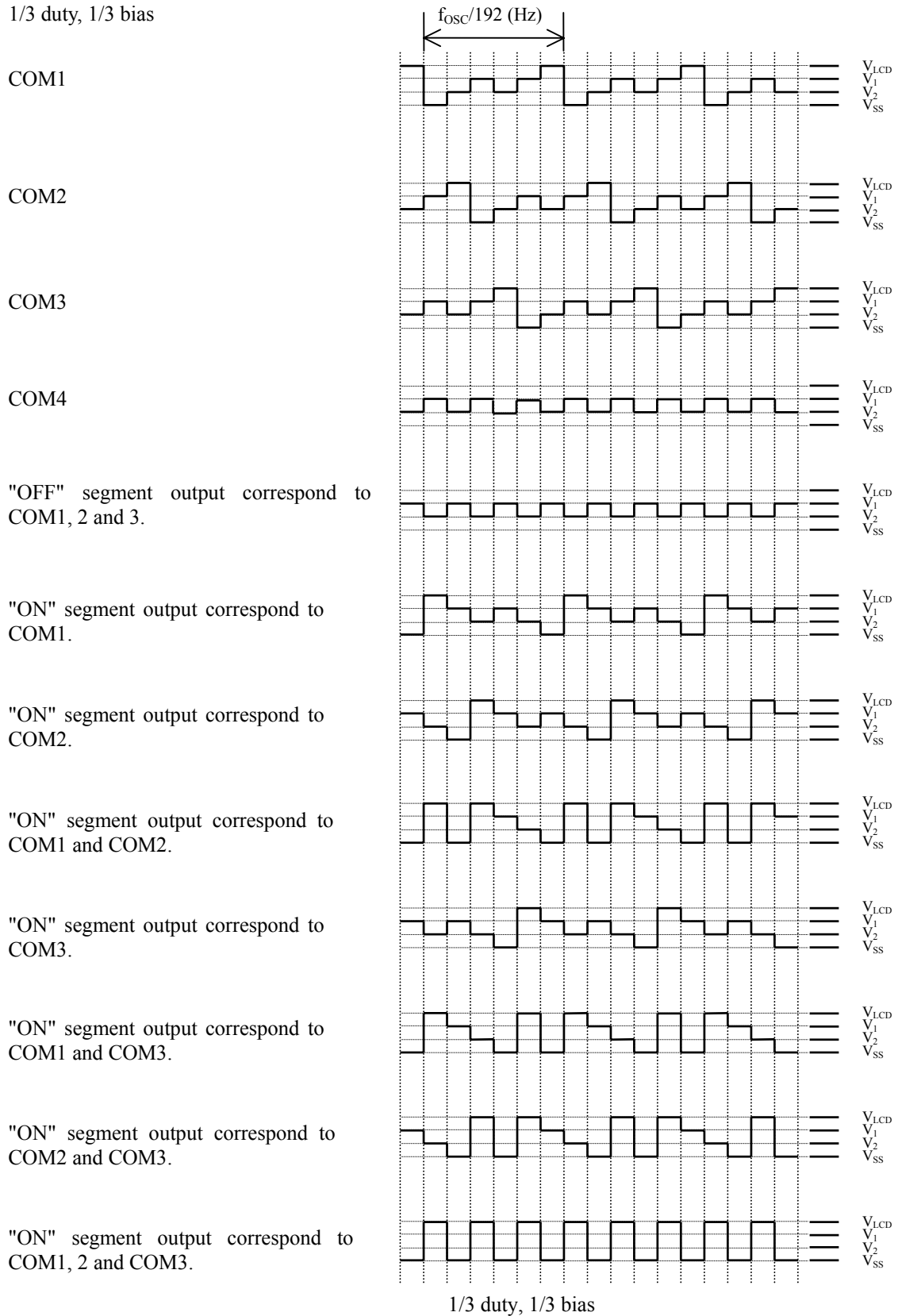

(c) 1/4 duty, 1/2 bias

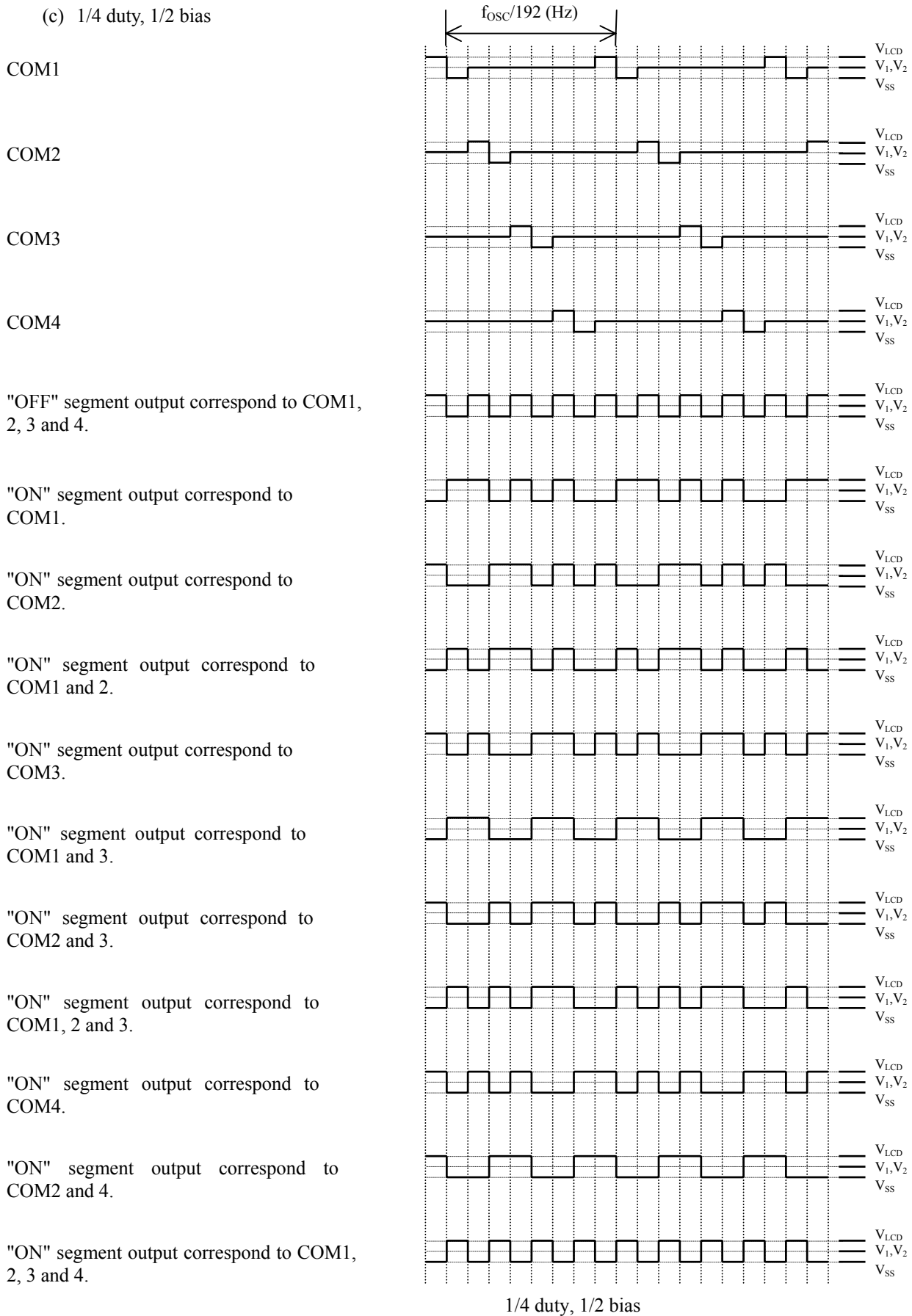

(d) 1/4 duty, 1/3 bias

COM1

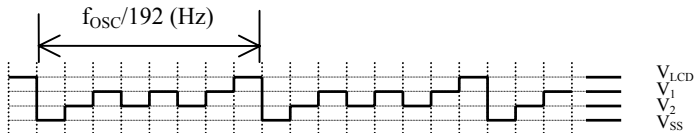

COM2

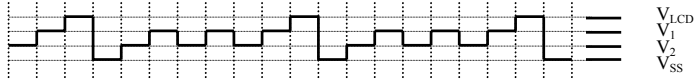

COM3



COM4

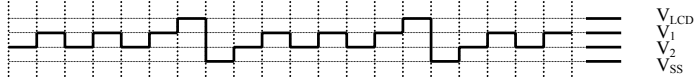

"OFF" segment output correspond to COM1, 2, 3 and 4.

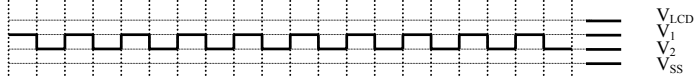

"ON" segment output correspond to COM1.

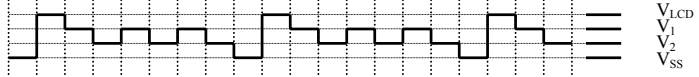

"ON" segment output correspond to COM2.

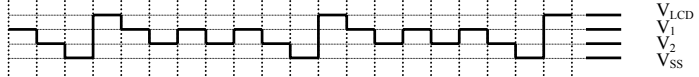

"ON" segment output correspond to COM1 and 2.

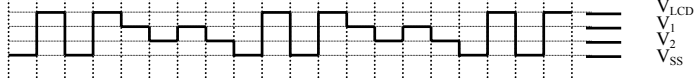

"ON" segment output correspond to COM3.

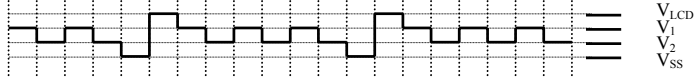

"ON" segment output correspond to COM1 and 3.

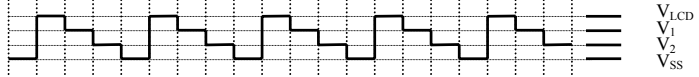

"ON" segment output correspond to COM2 and 3.

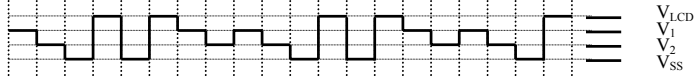

"ON" segment output correspond to COM1, 2 and 3.



"ON" segment output correspond to COM4.



"ON" segment output correspond to COM2 and 4.

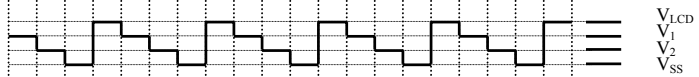

"ON" segment output correspond to COM1, 2, 3 and 4.

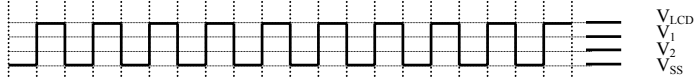

1/4 duty, 1/3 bias

NJU6533

APPLICATION CIRCUIT

- 1/4 duty, 1/3 bias

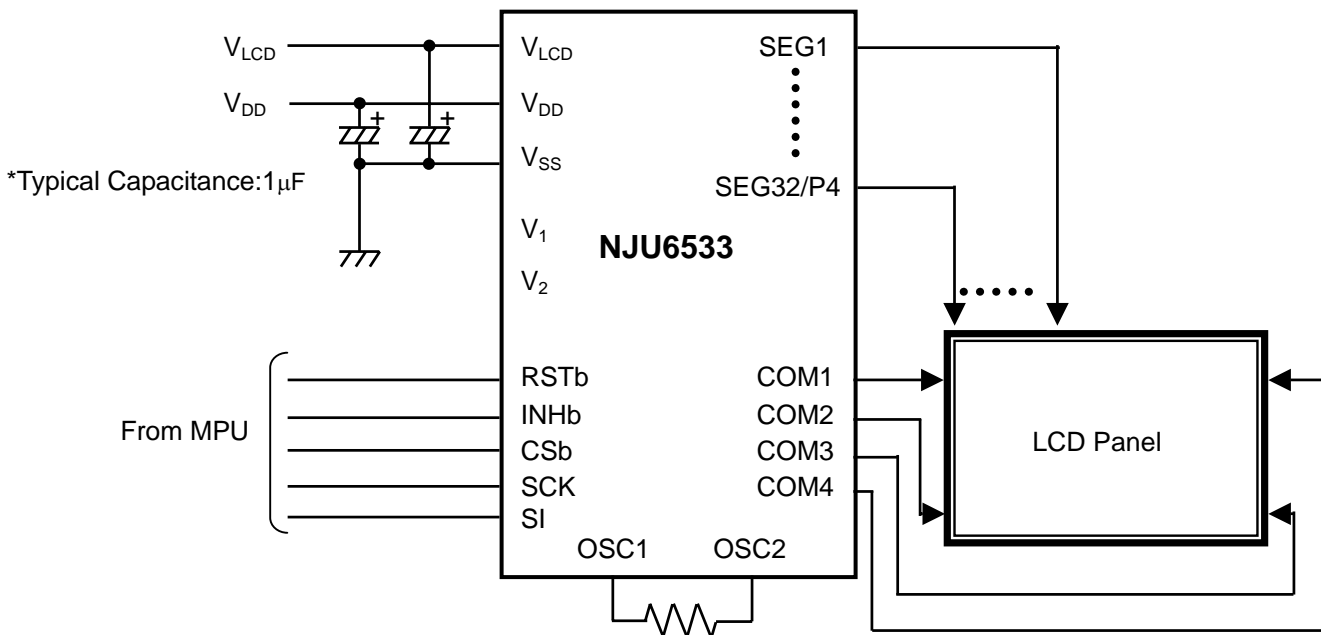

- 1/4 duty, 1/2 bias

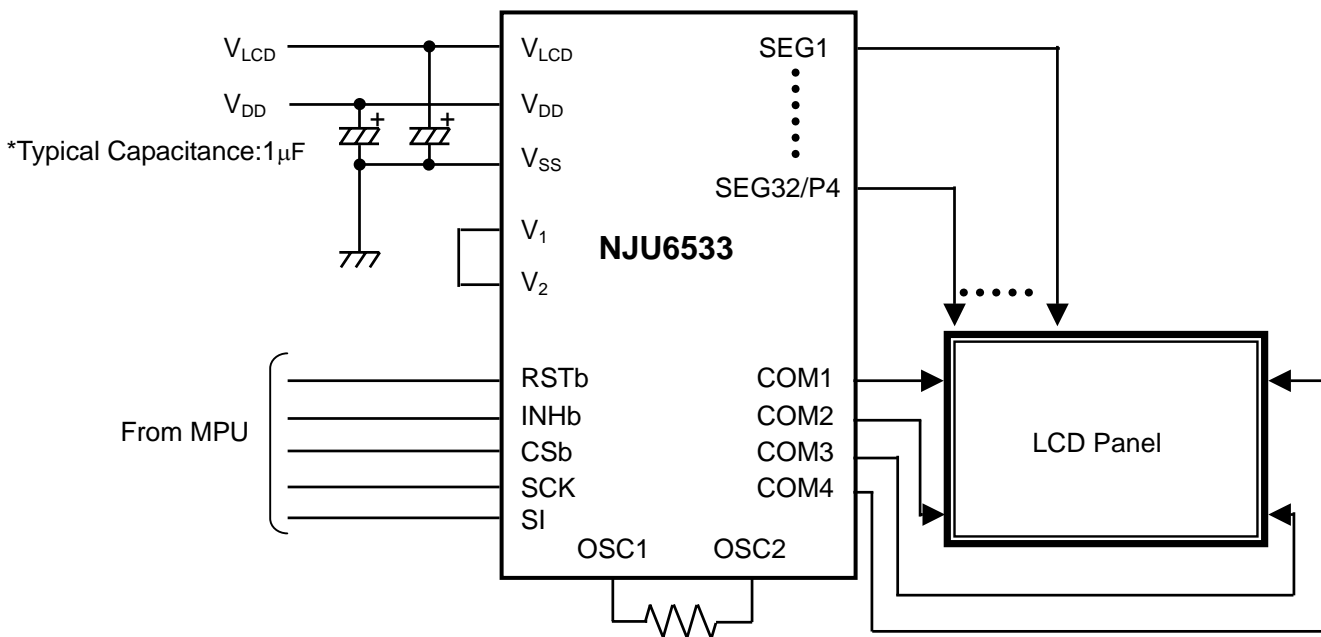

Note) Because display data is not yet stable just after V_{DD} on, if LCD panel is turned on, unexpected pattern will be displayed, therefore, keep INHb terminal to "L" level until data transfer from MPU is over.

[CAUTION]
 The specifications on this databook are only given for information, without any guarantee as regards either mistakes or omissions. The application circuits in this databook are described only to show representative usages of the product and not intended for the guarantee or permission of any right including the industrial rights.

Mouser Electronics

Authorized Distributor

Click to View Pricing, Inventory, Delivery & Lifecycle Information:

[NJR:](#)

[NJU6533FA2](#) [NJU6533FG1](#) [NJU6533KQ1-TE4](#)

Данный компонент на территории Российской Федерации

Вы можете приобрести в компании MosChip.

Для оперативного оформления запроса Вам необходимо перейти по данной ссылке:

<http://moschip.ru/get-element>

Вы можете разместить у нас заказ для любого Вашего проекта, будь то серийное производство или разработка единичного прибора.

В нашем ассортименте представлены ведущие мировые производители активных и пассивных электронных компонентов.

Нашей специализацией является поставка электронной компонентной базы двойного назначения, продукции таких производителей как XILINX, Intel (ex.ALTERA), Vicor, Microchip, Texas Instruments, Analog Devices, Mini-Circuits, Amphenol, Glenair.

Сотрудничество с глобальными дистрибьюторами электронных компонентов, предоставляет возможность заказывать и получать с международных складов практически любой перечень компонентов в оптимальные для Вас сроки.

На всех этапах разработки и производства наши партнеры могут получить квалифицированную поддержку опытных инженеров.

Система менеджмента качества компании отвечает требованиям в соответствии с ГОСТ Р ИСО 9001, ГОСТ РВ 0015-002 и ЭС РД 009

Офис по работе с юридическими лицами:

105318, г.Москва, ул.Щербаковская д.3, офис 1107, 1118, ДЦ «Щербаковский»

Телефон: +7 495 668-12-70 (многоканальный)

Факс: +7 495 668-12-70 (доб.304)

E-mail: info@moschip.ru

Skype отдела продаж:

moschip.ru

moschip.ru_4

moschip.ru_6

moschip.ru_9