

ZL2102DEMO1Z

Demonstration Board

AN1874
Rev 0.00
August 6, 2013

Description

The ZL2102DEMO1Z is an innovative power conversion and management IC that combines an integrated synchronous step-down DC/DC converter with key power and fault management functions in small package, resulting in a flexible and integrated solution. The ZL2102DEMO1Z platform allows quick evaluation of the highly configurable ZL2102DEMO1Z's performance and features in either stand-alone mode or via the SMBus™ interface using Intersil's PowerNavigator GUI software.

Specifications

This board has been configured and optimized for the following operating conditions:

- $V_{IN} = 12V$
- $V_{OUT} = 3.3V$
- $I_{MAX} = 6A$
- $f_{SW} = 600kHz$
- Peak efficiency: >85% at 50% load
- Output ripple: <0.5% at 6A
- Dynamic response: 3.5%
(3A to 5A and 5A to 3A steps, $di/dt = 2.5A/\mu s$)
- Board temperature: +25 °C

Key Board Features

- Small, compact design
- SMBus™ control interface
- V_{IN} range of 7.5V to 14V
- V_{OUT} adjustable from 0.6 V to 3.6 V
- Convenient power connection
- Onboard enable switch
- Power-good indicator
- Interconnectivity with other intersil demo boards

References

FN8440 "ZL2102" Data Sheet.

Ordering Information

PART NUMBER	DESCRIPTION
ZL2102DEMO1Z	ZL2102 Evaluation Kit, one channel (EVB, USB Adapter, Cable, Software)

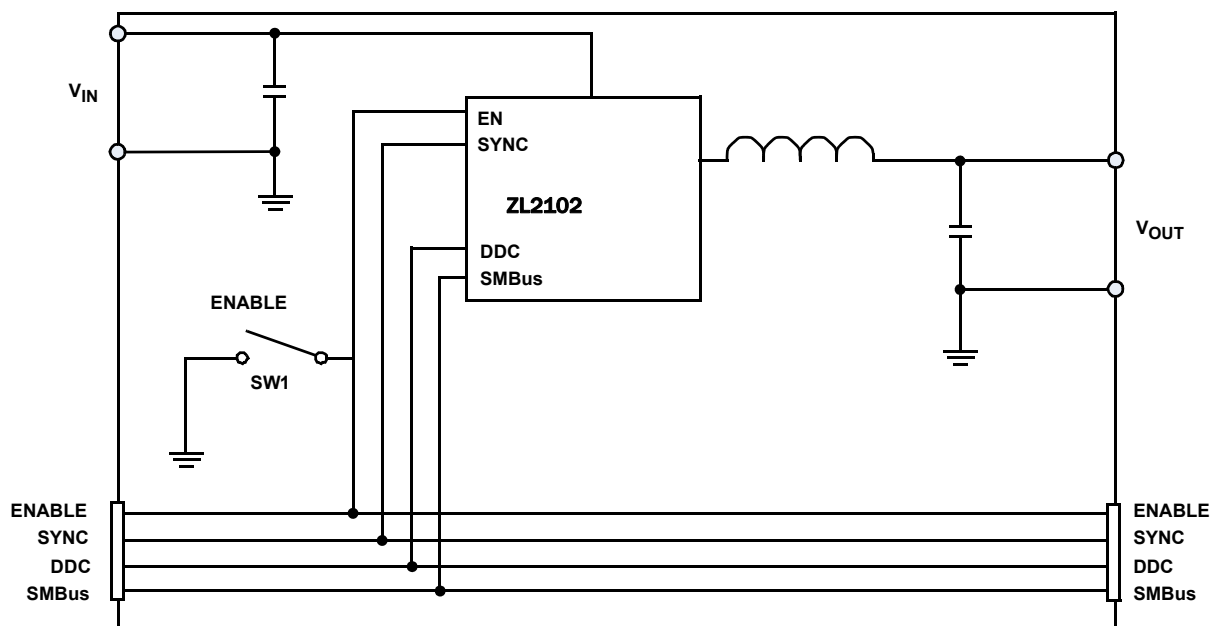

FIGURE 1. ZL2102DEMO1Z BLOCK DIAGRAM

Functional Description

The ZL2102DEMO1Z Demo Board provides a simple platform to demonstrate the features of the ZL2102. The ZL2102DEMO1Z has a functionally optimized ZL2102 circuit layout that allows efficient operation up to the maximum output current. Power and load connections are provided through plug-in sockets. Standalone operation is achieved using a combination of pin-strap settings and stored settings. The pin-strap setting details are described in the ZL2102 data sheet. The stored settings are listed in “Default Configuration Settings” on page 11. The ZL2102DEMO1Z Demonstration Board is shown in Figure 2 and Figure 3. The hardware enable function is controlled by a toggle switch. The power-good (PG) LED indicates that V_{OUT} is regulating. The right angle headers at opposite ends of the board are for connecting a USB to SMBus control board or for daisy chaining of multiple Intersil evaluation boards.

Connecting multiple Intersil Zilker Lab boards allows the user to setup many shared features such as clock synchronization, controlled sequencing, phase spreading, and fault spreading within Intersil's Power Navigator software as part of a single power project. The ZL2102DEMO1Z Circuit Schematic (Figure 9) shows the schematic, bill of materials, and PCB layers for reference. Figures 10 through 13 show performance data taken using this hardware in its optimized configuration. The configuration settings that the hardware ships with are shown on Page 11.

Operating Range

By default, the ZL2102DEMO1Z is configured for the operating conditions shown in “USB (PMBus) Operation”. The board can also support a wider operating range, and modifying the operating conditions will change the performance results.

The board V_{IN} range is 7.5V to 14V. The board V_{OUT} setting is fixed at 3.3V by pin strap setting, but the programmable range is 0.54V to 3.6V (including margin high/low). The output voltage can be changed by using the $V_{OUT_COMMAND}$ PMBus command. The board I_{OUT} range is 0 to 6A. For continuous operation at 6A, airflow across the board may be needed.

The switching frequency (f_{SW}) is set to 600kHz by PMBus command, but the f_{SW} setting can be changed by using the $FREQUENCY_SWITCH$ PMBus command (while the device is disabled). The f_{SW} range is 200kHz to 1MHz.

PCB Layout Notes

The ZL2102DEMO1Z PCB layout has been optimized for electrical and thermal performance.

The following key features are:

- The large 5x5 via pattern under the ZL2102 is connected to a large copper plane for effective thermal dissipation.
- SGND and power GND are isolated. The ZL2102's thermal pad is connected to the isolated SGND plane which is then reconnected to the power GND plane at pin 14 of ZL2102 on inner layer 1.
- The VSEN pin is Kelvin connected to C2 through inner layer 2 for improved noise performance.

Quick Start Guide

Stand Alone Operation

1. Ensure that the board is properly connected to the supply and loads prior to applying any power.
2. Connect the input supply to VIN and GND.
3. Connect the load to VOUT and GND.
4. Set ENABLE switch to “DISABLE”.
5. Turn input power supply ON.
6. Set ENABLE switch to “ENABLE”.
7. Test ZL2102 operation.

USB (PMBus) Operation

1. Follow step 1 through 5 of Stand Alone Operation.
2. Download PowerNavigator software from the Intersil website and install.
3. Connect USB-to-SMBus interface board to J2 of ZL2102DEMO1Z.
4. Set voltage to desired value in GUI.
5. Set ENABLE switch on EVB to “ENABLE”.
6. Monitor and configure EVB using PMBus commands in the evaluation software.
7. Test ZL2102 operation using the evaluation software.

ZL2102DEMO1Z Evaluation Board

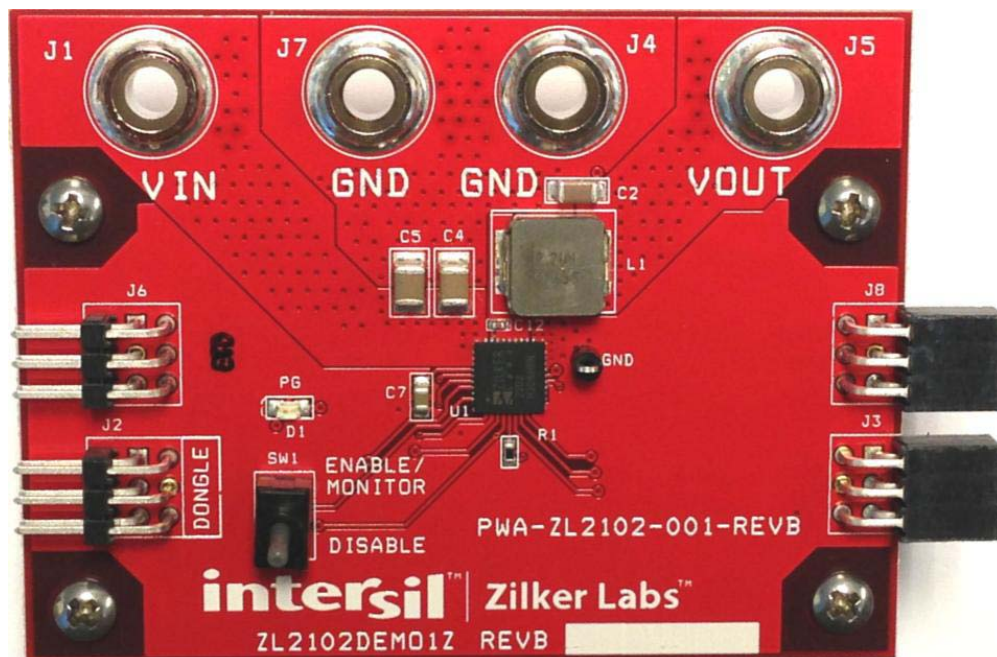

FIGURE 2. TOP SIDE

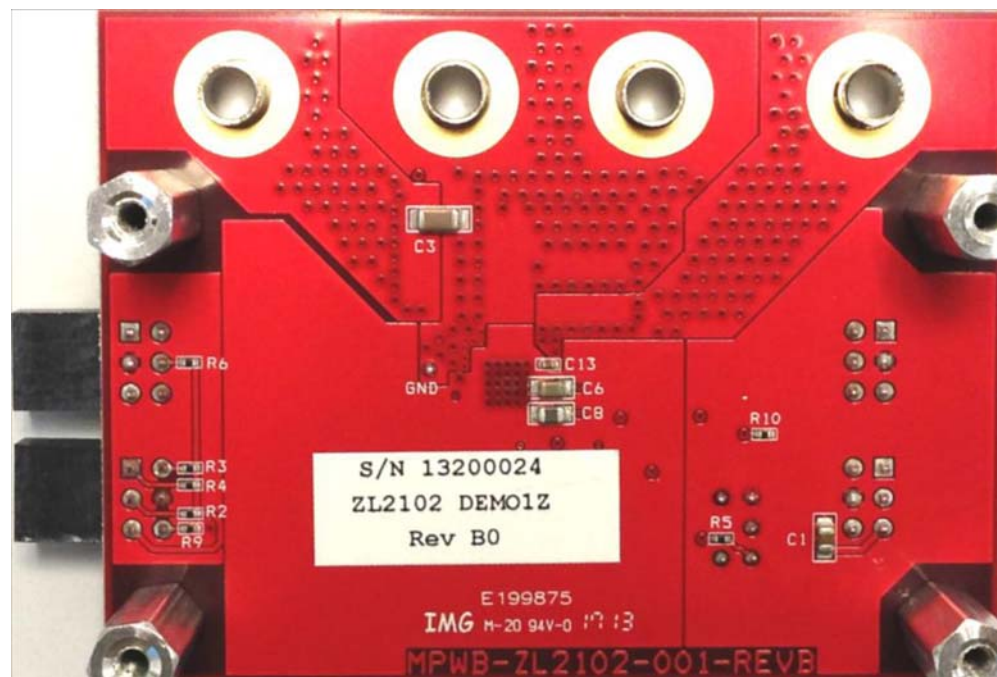

FIGURE 3. BOTTOM SIDE

ZL2102DEMO1Z Circuit Schematic

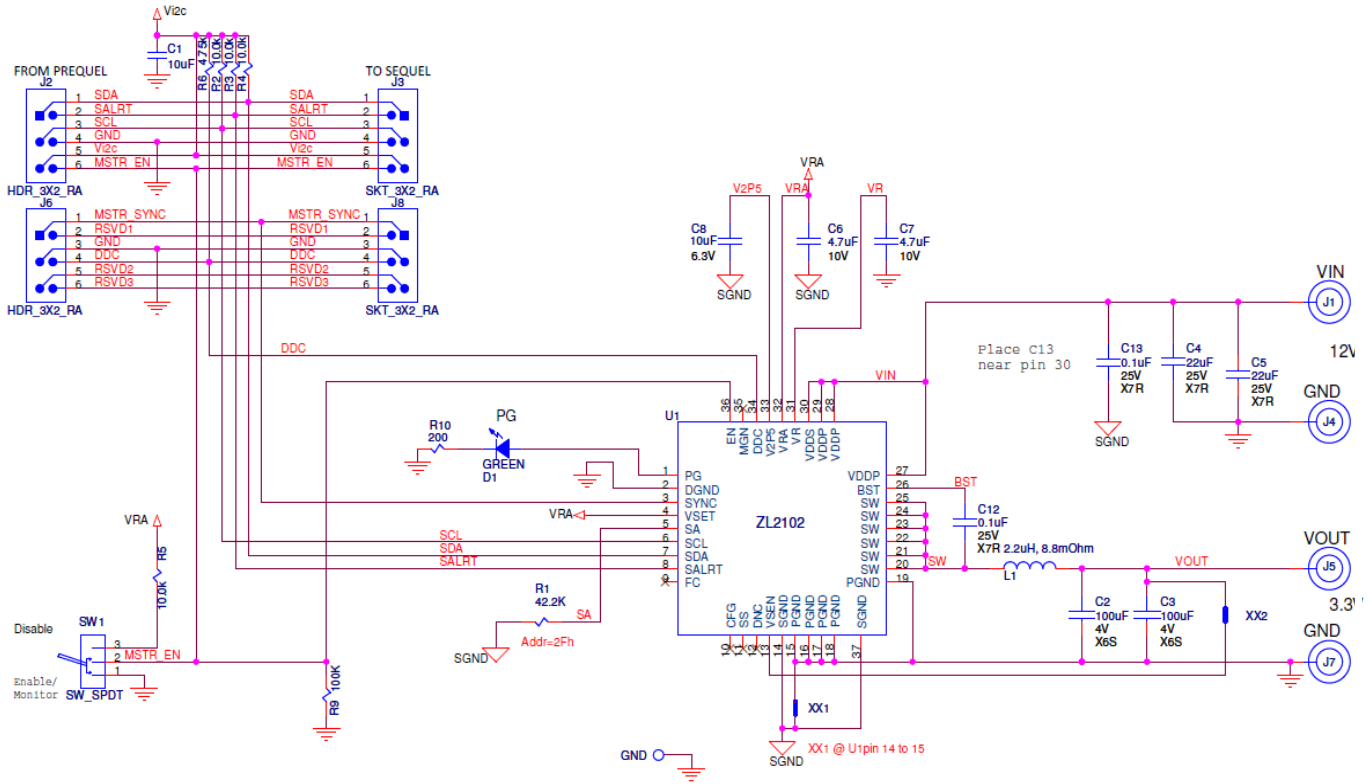

TABLE 1. BILL OF MATERIALS

ZL2102DEMO1Z CIRCUIT RSCH-ZL2102-001 Revision: B									
ITEM	QTY	REFERENCE DESIGNATOR	VALUE	TOL (%)	RATING	TYPE	PCB FOOTPRINT	MANUFACTURER	PART NUMBER
1	1	C1	10µF	10	10V	X7R	SM0805	Taiyo Yuden	LMK212B7106KG-TD
2	2	C2, C3	100µF	20	4V	X6S	SM1206	TDK Corporation	C3216X6S0G107M
3	2	C4, C5	22µF	20	25V	X7R	SM1210	Taiyo Yuden	TMK325B7226MM-TR
4	2	C6, C7	4.7µF	20	10V	X5R	SM0805	PANASONIC-ECG	ECJ-GVB1A475M
5	1	C8	10µF	20	6.3V	X5R	SM0805	MURATA	GRM21BR60J106ME19L
6	2	C12, C13	0.1µF	10	25V	X7R	SM0402	TDK Corporation	C1005X7R1E104K
7	1	D1	GREEN		2V, 20mA	LED	SM0805	CHICAGO MINIATURE	CMD17-21VGC/TR8
8	4	J1, J4, J5, J7	JACK_BANANA			Banana Jack	JACK_KEYSTONE_575-4	Keystone	575-4
9	2	J2, J6	HDR_3X2_RA			RA	HDRM3DUALRA100X100	SAMTEC	TSW-103-08-T-D-RA
10	2	J3, J8	SKT_3X2_RA			RA	HDRF3DUALRA100X100	SAMTEC	SSQ-103-02-T-D-RA
11	1	L1	2.2µH, 8.8mΩ	20	14.5A		8.64mm x 8.18mm	Vishay Dale	IHLP3232DZER2R2M11
12	1	R1	42.2k	1	100mW	THK FILM	SM0603	PANASONIC-ECG	ERJ-3EKF4222V
13	4	R2, R3, R4, R5	10.0k	1	63mW	THK FILM	SM0402	YAGEO	RC0402FR-0710KL
14	1	R6	4.75k	1	100mW	THK FILM	SM0402	PANASONIC-ECG	ERJ-2RKF4751X
15	1	R9	100k	1	63mW	THK FILM	SM0402	Stackpole Electronics Inc	RMCF0402JT100K
16	1	R10	200	1	100mW	THK FILM	SM0402	Panasonic-ECG	ERJ-2RKF2000XR
17	1	SW1	SW_SPDT			PCB VERT	SW_TOG_ULTRAMIN_SPDT	NKK	G12AP
18	1	TP1	GND				TP_036H_SVAL2S		
19	1	U1	ZL2102				MLF36	INTERSIL	ZL2102ALAF
20	NS	XX1, XX2	TIEPT/10WIDE				TIEPT/10WIDE		
21	4	XX3, XX4, XX5, XX6	STANDOFF_#4-40.75LG				STANDOFF_4-40_NDH		
22	4	XX7, XX8, XX9, XX10	SCREW_#4-40x0.25"			PHL	SCREW_40-40	BUILDING FASTENERS	PMS4400025PH
23	1	XX11	PCB				BDOTLN3.0HX4.0L	INTERSIL	MPWB-ZL2102-001

Board Layout - 4 Layers

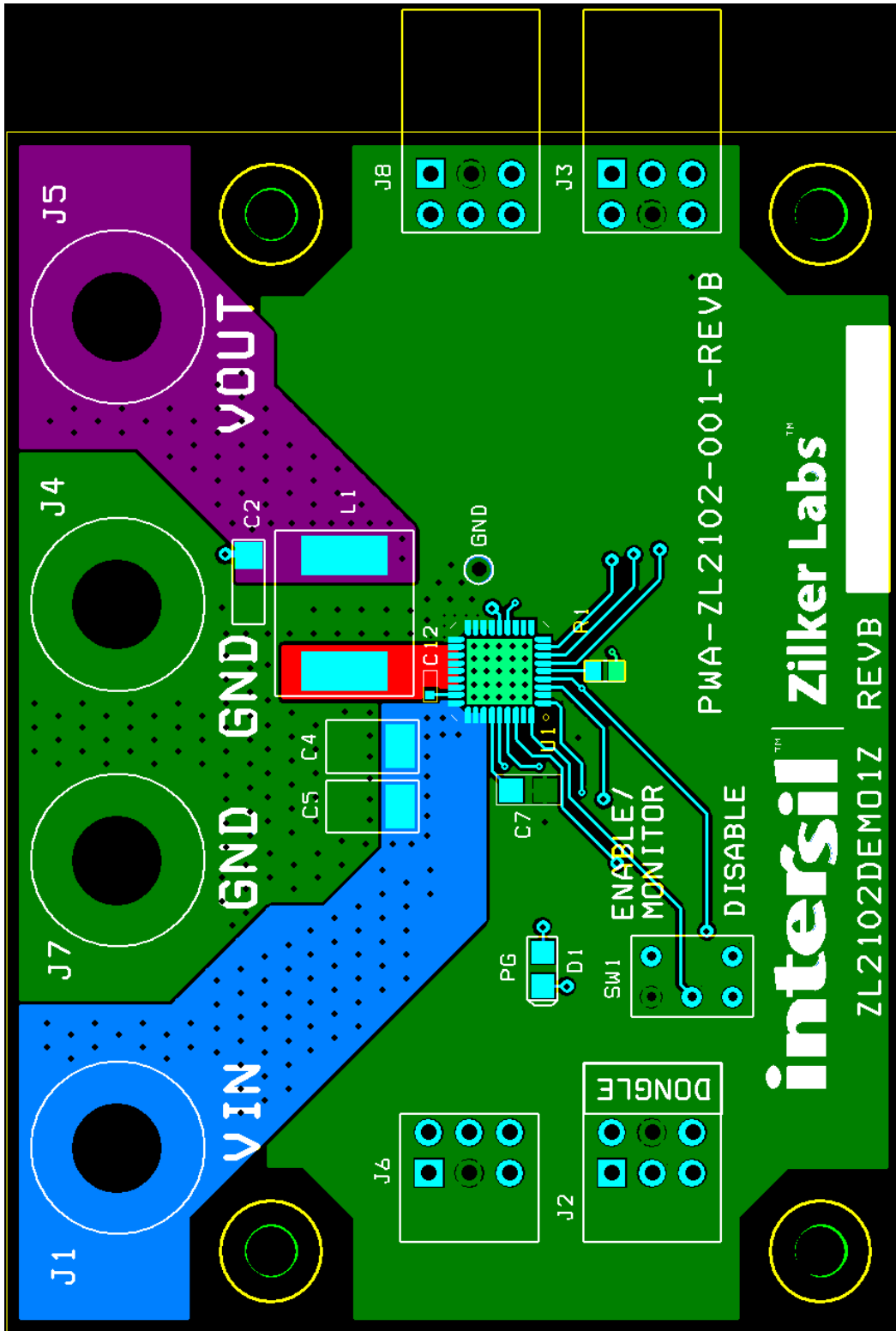

FIGURE 4. TOP LAYER

Board Layout - 4 Layers (Continued)

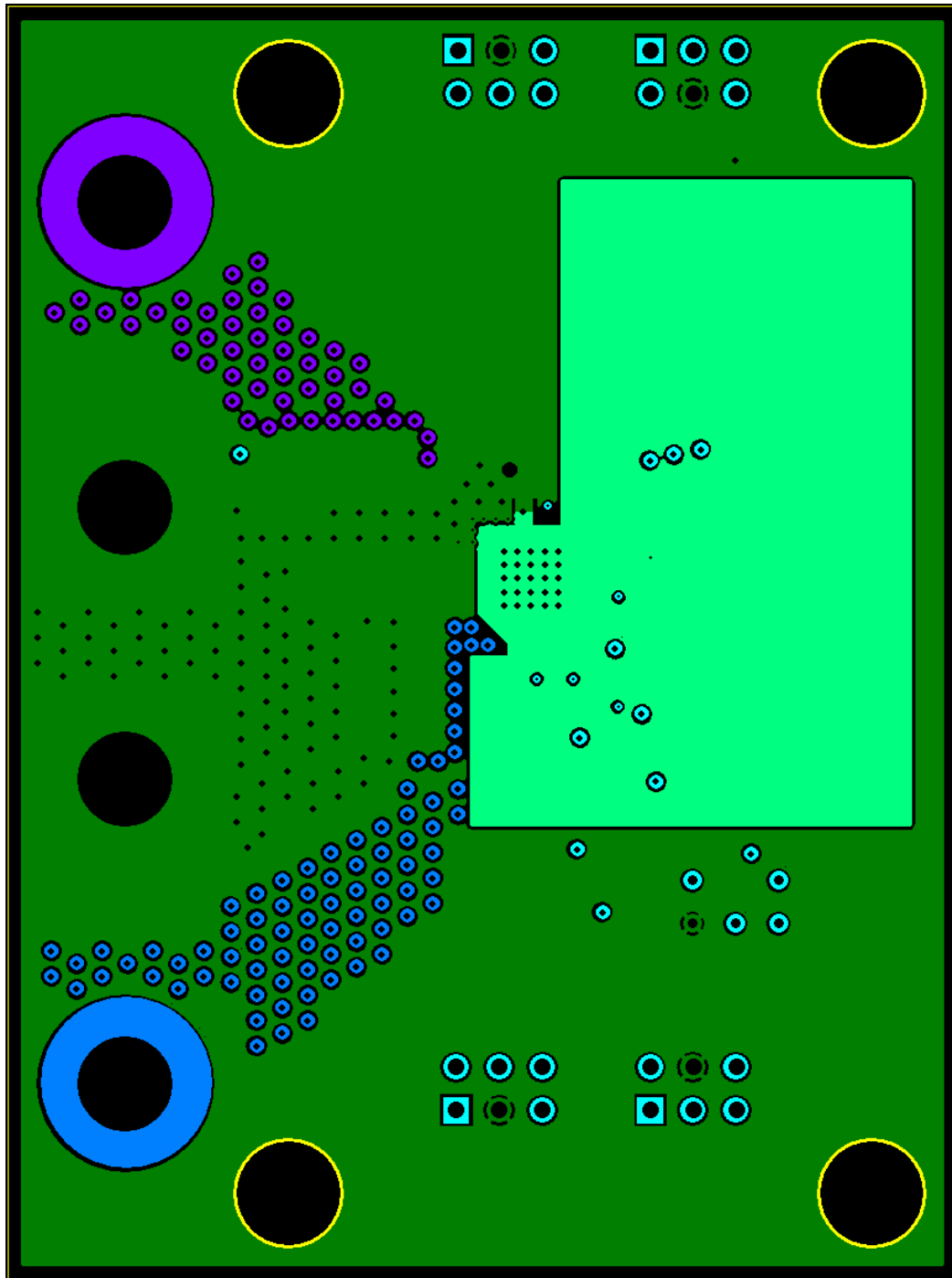

FIGURE 5. PCB - INNER LAYER 1 (VIEWED FROM TOP)

Board Layout - 4 Layers (Continued)

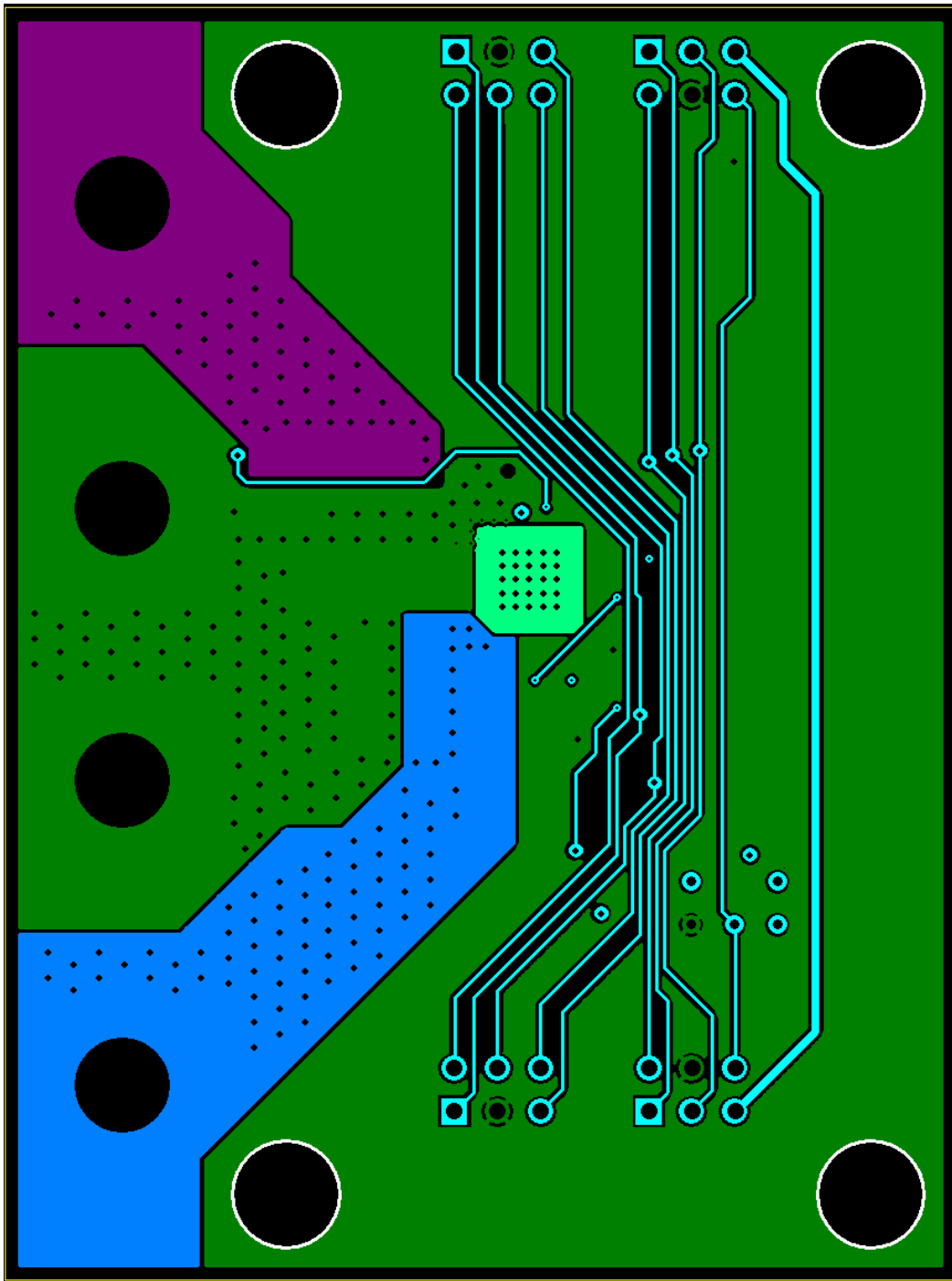

FIGURE 6. PCB - INNER LAYER 2 (VIEWED FROM TOP)

Board Layout - 4 Layers (Continued)

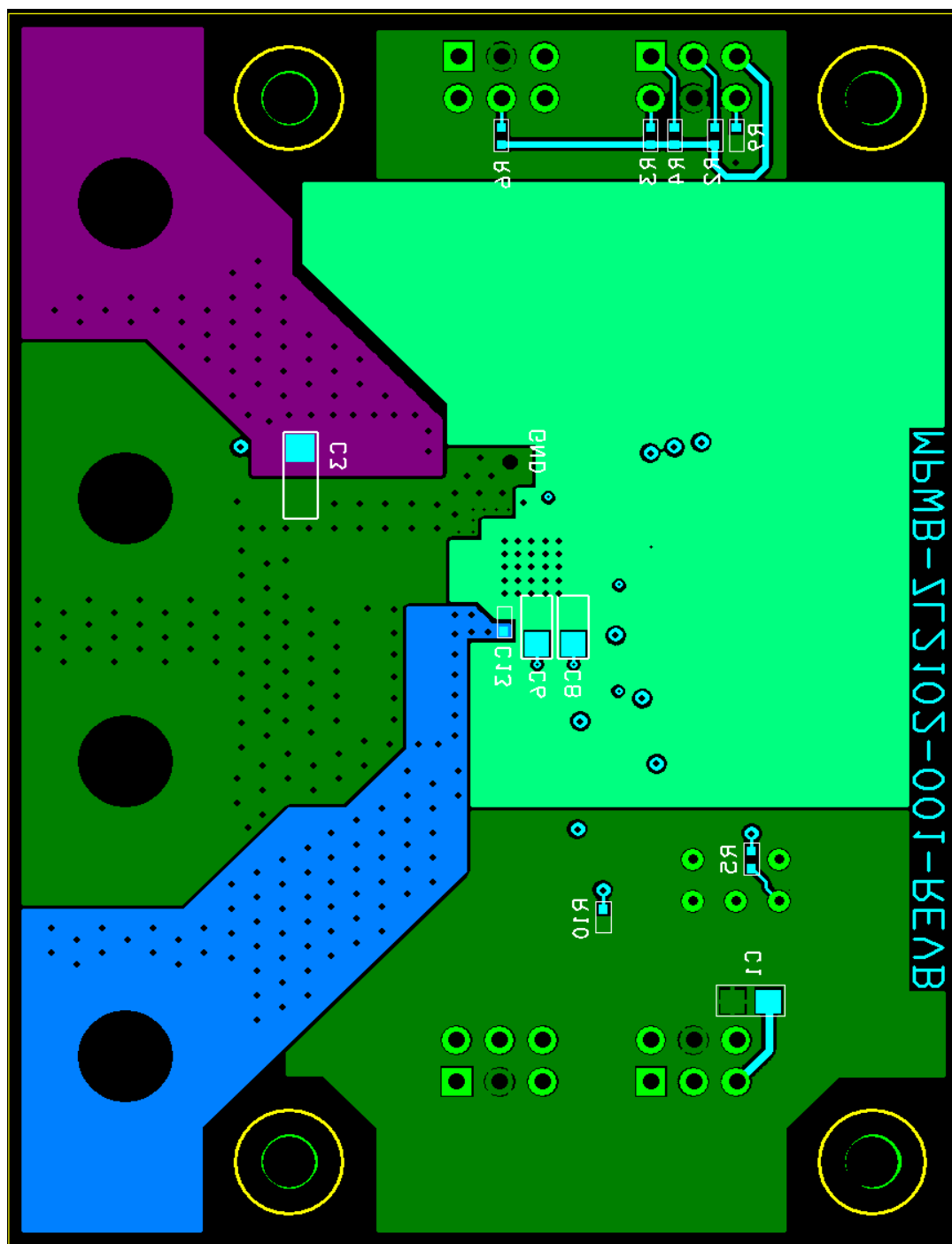

FIGURE 7. PCB - BOTTOM LAYER (VIEWED FROM TOP)

Typical Performance Curves

Unless noted: $V_{IN} = 12\text{ V}$, $V_{OUT} = 3.3\text{ V}$, $f_{SW} = 400\text{ kHz}$, $T_A = 25\text{ }^\circ\text{C}$

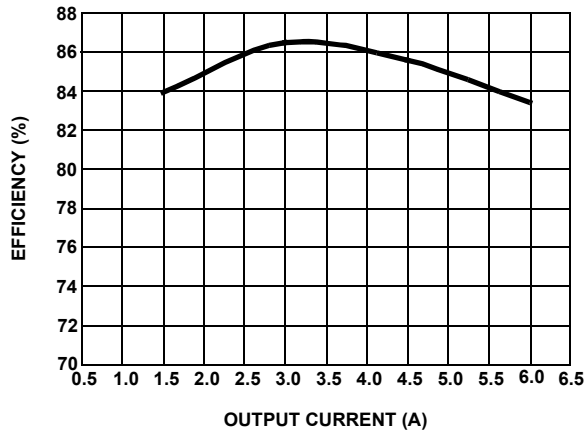

FIGURE 8. MEASURED EFFICIENCY $V_{IN} = 12\text{V}$, $V_{OUT} = 3.3\text{V}$

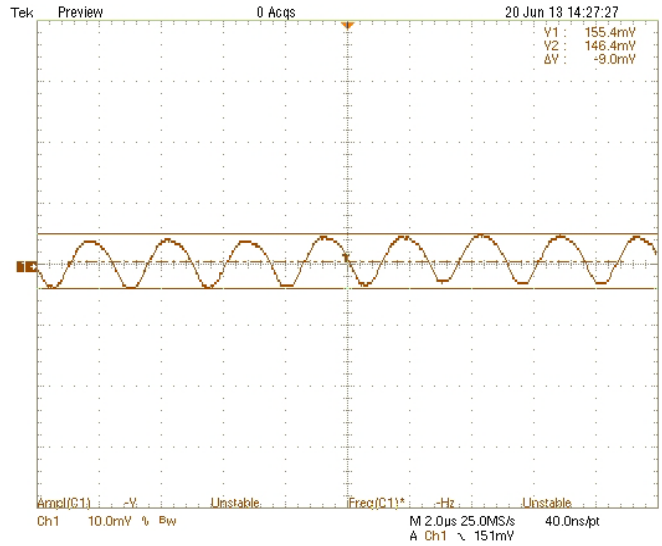

FIGURE 9. OUTPUT RIPPLE MEASURED ACROSS C3

Dynamic Response

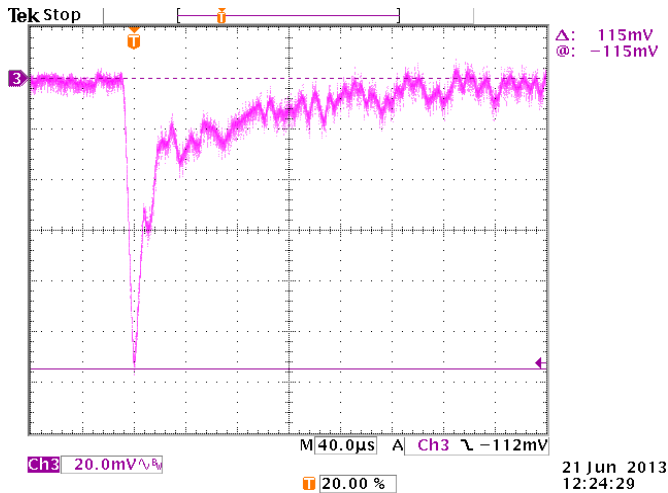

FIGURE 10. (3 - 5 A LOAD STEP, $di/dt = 2.5\text{A}/\mu\text{s}$)

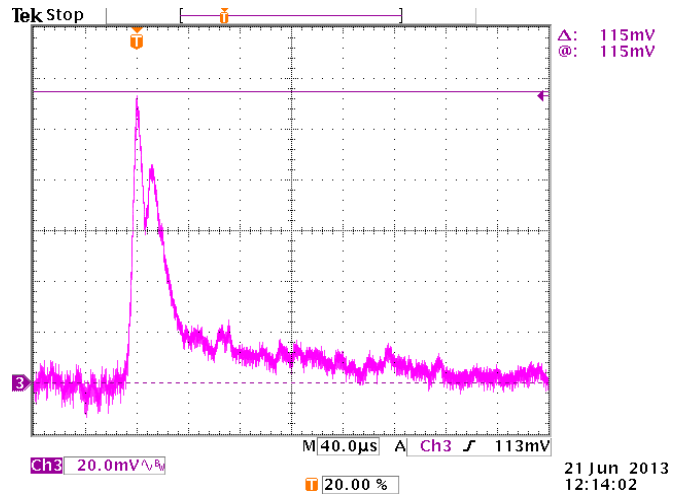

FIGURE 11. (5 - 3 A LOAD STEP, $di/dt = 2.5\text{A}/\mu\text{s}$)

Dynamic Response (Continued)



FIGURE 12. DEFAULT RAMP-UP TIME SETTING OF 5ms DELAY, 10ms RISE



FIGURE 13. RAMP-DOWN TIME SETTING OF 5ms Delay, 10ms FALL

Default Configuration Settings

Most configuration settings for this design set by pin strap or are the factory defaults. The following configuration settings are loaded into the ZL2102DEMO1Z for additional performance optimization.

- (Set PG pin to push-pull for demo board LED operation)

MFR_CONFIG: x4803

- (Set switching frequency to 600 kHz)

FREQUENCY_SWITCH: 0x0258

The following additional settings should be used for best transient performance:

- (Set switching frequency to 800 kHz)

FREQUENCY_SWITCH: 0x0320

- (Set Auto Comp for 100% gain)

AUTO_COMP_CONFIG: 0x99

Notice

1. Descriptions of circuits, software and other related information in this document are provided only to illustrate the operation of semiconductor products and application examples. You are fully responsible for the incorporation or any other use of the circuits, software, and information in the design of your product or system. Renesas Electronics disclaims any and all liability for any losses and damages incurred by you or third parties arising from the use of these circuits, software, or information.
2. Renesas Electronics hereby expressly disclaims any warranties against and liability for infringement or any other claims involving patents, copyrights, or other intellectual property rights of third parties, by or arising from the use of Renesas Electronics products or technical information described in this document, including but not limited to, the product data, drawings, charts, programs, algorithms, and application examples.
3. No license, express, implied or otherwise, is granted hereby under any patents, copyrights or other intellectual property rights of Renesas Electronics or others.
4. You shall not alter, modify, copy, or reverse engineer any Renesas Electronics product, whether in whole or in part. Renesas Electronics disclaims any and all liability for any losses or damages incurred by you or third parties arising from such alteration, modification, copying or reverse engineering.
5. Renesas Electronics products are classified according to the following two quality grades: "Standard" and "High Quality". The intended applications for each Renesas Electronics product depends on the product's quality grade, as indicated below.
"Standard": Computers; office equipment; communications equipment; test and measurement equipment; audio and visual equipment; home electronic appliances; machine tools; personal electronic equipment; industrial robots; etc.
"High Quality": Transportation equipment (automobiles, trains, ships, etc.); traffic control (traffic lights); large-scale communication equipment; key financial terminal systems; safety control equipment; etc.
Unless expressly designated as a high reliability product or a product for harsh environments in a Renesas Electronics data sheet or other Renesas Electronics document, Renesas Electronics products are not intended or authorized for use in products or systems that may pose a direct threat to human life or bodily injury (artificial life support devices or systems; surgical implantations; etc.), or may cause serious property damage (space system; undersea repeaters; nuclear power control systems; aircraft control systems; key plant systems; military equipment; etc.). Renesas Electronics disclaims any and all liability for any damages or losses incurred by you or any third parties arising from the use of any Renesas Electronics product that is inconsistent with any Renesas Electronics data sheet, user's manual or other Renesas Electronics document.
6. When using Renesas Electronics products, refer to the latest product information (data sheets, user's manuals, application notes, "General Notes for Handling and Using Semiconductor Devices" in the reliability handbook, etc.), and ensure that usage conditions are within the ranges specified by Renesas Electronics with respect to maximum ratings, operating power supply voltage range, heat dissipation characteristics, installation, etc. Renesas Electronics disclaims any and all liability for any malfunctions, failure or accident arising out of the use of Renesas Electronics products outside of such specified ranges.
7. Although Renesas Electronics endeavors to improve the quality and reliability of Renesas Electronics products, semiconductor products have specific characteristics, such as the occurrence of failure at a certain rate and malfunctions under certain use conditions. Unless designated as a high reliability product or a product for harsh environments in a Renesas Electronics data sheet or other Renesas Electronics document, Renesas Electronics products are not subject to radiation resistance design. You are responsible for implementing safety measures to guard against the possibility of bodily injury, injury or damage caused by fire, and/or danger to the public in the event of a failure or malfunction of Renesas Electronics products, such as safety design for hardware and software, including but not limited to redundancy, fire control and malfunction prevention, appropriate treatment for aging degradation or any other appropriate measures. Because the evaluation of microcomputer software alone is very difficult and impractical, you are responsible for evaluating the safety of the final products or systems manufactured by you.
8. Please contact a Renesas Electronics sales office for details as to environmental matters such as the environmental compatibility of each Renesas Electronics product. You are responsible for carefully and sufficiently investigating applicable laws and regulations that regulate the inclusion or use of controlled substances, including without limitation, the EU RoHS Directive, and using Renesas Electronics products in compliance with all these applicable laws and regulations. Renesas Electronics disclaims any and all liability for damages or losses occurring as a result of your noncompliance with applicable laws and regulations.
9. Renesas Electronics products and technologies shall not be used for or incorporated into any products or systems whose manufacture, use, or sale is prohibited under any applicable domestic or foreign laws or regulations. You shall comply with any applicable export control laws and regulations promulgated and administered by the governments of any countries asserting jurisdiction over the parties or transactions.
10. It is the responsibility of the buyer or distributor of Renesas Electronics products, or any other party who distributes, disposes of, or otherwise sells or transfers the product to a third party, to notify such third party in advance of the contents and conditions set forth in this document.
11. This document shall not be reprinted, reproduced or duplicated in any form, in whole or in part, without prior written consent of Renesas Electronics.
12. Please contact a Renesas Electronics sales office if you have any questions regarding the information contained in this document or Renesas Electronics products.
(Note 1) "Renesas Electronics" as used in this document means Renesas Electronics Corporation and also includes its directly or indirectly controlled subsidiaries.
(Note 2) "Renesas Electronics product(s)" means any product developed or manufactured by or for Renesas Electronics.

(Rev.4.0-1 November 2017)



SALES OFFICES

Renesas Electronics Corporation

<http://www.renesas.com>

Refer to "<http://www.renesas.com/>" for the latest and detailed information.

Renesas Electronics America Inc.
1001 Murphy Ranch Road, Milpitas, CA 95035, U.S.A.
Tel: +1-408-432-8888, Fax: +1-408-434-5351

Renesas Electronics Canada Limited
9251 Yonge Street, Suite 8309 Richmond Hill, Ontario Canada L4C 9T3
Tel: +1-905-237-2004

Renesas Electronics Europe Limited
Dukes Meadow, Millboard Road, Bourne End, Buckinghamshire, SL8 5FH, U.K
Tel: +44-1628-651-700, Fax: +44-1628-651-804

Renesas Electronics Europe GmbH
Arcadiastrasse 10, 40472 Düsseldorf, Germany
Tel: +49-211-6503-0, Fax: +49-211-6503-1327

Renesas Electronics (China) Co., Ltd.
Room 1709 Quantum Plaza, No.27 ZhichunLu, Haidian District, Beijing, 100191 P. R. China
Tel: +86-10-8235-1155, Fax: +86-10-8235-7679

Renesas Electronics (Shanghai) Co., Ltd.
Unit 301, Tower A, Central Towers, 555 Langao Road, Putuo District, Shanghai, 200333 P. R. China
Tel: +86-21-2226-0888, Fax: +86-21-2226-0999

Renesas Electronics Hong Kong Limited
Unit 1601-1611, 16/F., Tower 2, Grand Century Place, 193 Prince Edward Road West, Mongkok, Kowloon, Hong Kong
Tel: +852-2265-6688, Fax: +852-2886-9022

Renesas Electronics Taiwan Co., Ltd.
13F, No. 363, Fu Shing North Road, Taipei 10543, Taiwan
Tel: +886-2-8175-9600, Fax: +886-2-8175-9670

Renesas Electronics Singapore Pte. Ltd.
80 Bendemeer Road, Unit #06-02 Hyflux Innovation Centre, Singapore 339949
Tel: +65-6213-0200, Fax: +65-6213-0300

Renesas Electronics Malaysia Sdn.Bhd.
Unit 1207, Block B, Menara Amcorp, Amcorp Trade Centre, No. 18, Jln Persiaran Barat, 46050 Petaling Jaya, Selangor Darul Ehsan, Malaysia
Tel: +60-3-7955-9390, Fax: +60-3-7955-9510

Renesas Electronics India Pvt. Ltd.
No.777C, 100 Feet Road, HAL 2nd Stage, Indiranagar, Bangalore 560 038, India
Tel: +91-80-67208700, Fax: +91-80-67208777

Renesas Electronics Korea Co., Ltd.
17F, KAMCO Yangjae Tower, 262, Gangnam-daero, Gangnam-gu, Seoul, 06265 Korea
Tel: +82-2-558-3737, Fax: +82-2-558-5338

Данный компонент на территории Российской Федерации

Вы можете приобрести в компании MosChip.

Для оперативного оформления запроса Вам необходимо перейти по данной ссылке:

<http://moschip.ru/get-element>

Вы можете разместить у нас заказ для любого Вашего проекта, будь то серийное производство или разработка единичного прибора.

В нашем ассортименте представлены ведущие мировые производители активных и пассивных электронных компонентов.

Нашей специализацией является поставка электронной компонентной базы двойного назначения, продукции таких производителей как XILINX, Intel (ex.ALTERA), Vicor, Microchip, Texas Instruments, Analog Devices, Mini-Circuits, Amphenol, Glenair.

Сотрудничество с глобальными дистрибьюторами электронных компонентов, предоставляет возможность заказывать и получать с международных складов практически любой перечень компонентов в оптимальные для Вас сроки.

На всех этапах разработки и производства наши партнеры могут получить квалифицированную поддержку опытных инженеров.

Система менеджмента качества компании отвечает требованиям в соответствии с ГОСТ Р ИСО 9001, ГОСТ РВ 0015-002 и ЭС РД 009

Офис по работе с юридическими лицами:

105318, г.Москва, ул.Щербаковская д.3, офис 1107, 1118, ДЦ «Щербаковский»

Телефон: +7 495 668-12-70 (многоканальный)

Факс: +7 495 668-12-70 (доб.304)

E-mail: info@moschip.ru

Skype отдела продаж:

moschip.ru

moschip.ru_4

moschip.ru_6

moschip.ru_9