

### FEATURES

Low cost, compact, current-sense solution

3 available gain versions

20 V/V (ADM4073T)

50 V/V (ADM4073F)

100 V/V (ADM4073H)

Typical  $\pm 1.0\%$  full-scale accuracy

Supply current: 500  $\mu\text{A}$

Wide bandwidth: 1.8 MHz

Operating supply: 3 V to 28 V

Wide common-mode range: 2 V to 28 V

Independent of supply voltage

Operating temperature range:  $-40^\circ\text{C}$  to  $+125^\circ\text{C}$

Available in a 6-lead SOT-23 package

Pin-to-pin compatibility with the MAX4073

### APPLICATIONS

Cell phones

PDA's

Notebook computers

Portable, battery-powered systems

Smart battery packs and chargers

Automotive

Power management systems

PA bias control

General system-level, board-level current monitoring

Precision current sources

### GENERAL DESCRIPTION

The ADM4073 is a low cost, high-side, current-sense amplifier ideal for small portable applications, such as cell phones, notebook computers, PDA's, and other systems where current monitoring is required. The device is available in three different gain models, eliminating the need for gain-setting resistors. Because the ground path is not interrupted, the ADM4073 is particularly useful in rechargeable battery-powered systems, while its wide 1.8 MHz bandwidth makes it suitable for use inside battery-charger control loops. The input common-mode range of 2 V to 28 V is independent of the supply voltage.

### FUNCTIONAL BLOCK DIAGRAM

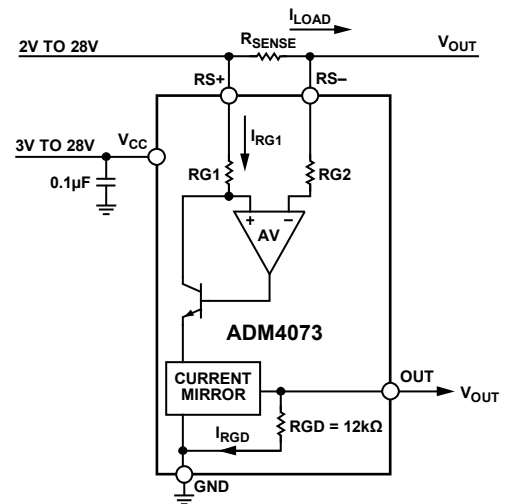

Figure 1.

05131-003

### APPLICATION DIAGRAM

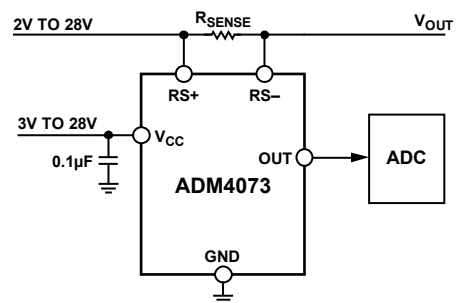

Figure 2.

05131-001

The voltage on the output pin is determined by the current flowing through the selectable external sense resistor and the gain of the version selected. The operating range is 3 V to 28 V with a typical supply current of 500  $\mu\text{A}$ .

The ADM4073 is available in a 6-lead SOT-23 package and is specified over the automotive operating temperature range ( $-40^\circ\text{C}$  to  $+125^\circ\text{C}$ ).

### Rev. A

Information furnished by Analog Devices is believed to be accurate and reliable. However, no responsibility is assumed by Analog Devices for its use, nor for any infringements of patents or other rights of third parties that may result from its use. Specifications subject to change without notice. No license is granted by implication or otherwise under any patent or patent rights of Analog Devices. Trademarks and registered trademarks are the property of their respective owners.

## TABLE OF CONTENTS

Features .....	1	ESD Caution.....	4
Applications.....	1	Pin Configuration and Function Descriptions.....	5
Functional Block Diagram .....	1	Typical Performance Characteristics .....	6
Application Diagram .....	1	Theory of Operation .....	10
General Description .....	1	R <sub>SENSE</sub> .....	10
Revision History .....	2	Output (OUT).....	10
Specifications.....	3	Outline Dimensions .....	11
Absolute Maximum Ratings.....	4	Ordering Guide .....	11
Thermal Characteristics .....	4		

## REVISION HISTORY

### 10/08—Rev. 0 to Rev. A

Changes to Theory of Operation Section and Output (OUT) Section.....	10
Changes to Ordering Guide .....	11

### 7/06—Revision 0: Initial Version

## SPECIFICATIONS

$V_{RS+} = 2\text{ V to } 28\text{ V}$ ,  $V_{SENSE} = (V_{RS+} - V_{RS-}) = 0\text{ V}$ ,  $V_{CC} = 3\text{ V to } 28\text{ V}$ ,  $T_A = -40^\circ\text{C to } +125^\circ\text{C}$ , unless otherwise noted. Typical values are at  $T_A = 25^\circ\text{C}$ .<sup>1</sup>

Table 1.

Parameter	Min	Typ	Max	Unit	Conditions
<b>POWER SUPPLY</b>					
Operating Voltage Range, $V_{CC}$	3		28	V	Inferred from PSRR test
Common-Mode Input Range, $V_{CMR}$	2		28	V	Inferred OUT voltage error test
Common-Mode Input Rejection, CMR		90		dB	$V_{SENSE} = 100\text{ mV}$ , $V_{CC} = 12\text{ V}$
Supply Current, $I_{CC}$		0.5	1.2	mA	$V_{CC} = 28\text{ V}$
Leakage Current, $I_{RS+}/I_{RS-}$		0.05	2	$\mu\text{A}$	$V_{CC} = 0\text{ V}$ , $V_{RS+} = 28\text{ V}$ , $T_A = 85^\circ\text{C}$
Input Bias Current, $I_{RS+}$		20	60	$\mu\text{A}$	
Input Bias Current, $I_{RS-}$		40	120	$\mu\text{A}$	
Full-Scale Sense Voltage, $V_{SENSE}$		150		mV	$V_{SENSE} = (V_{RS+} - V_{RS-})$
Total Output Voltage Error <sup>2</sup>		$\pm 1$		%	$V_{SENSE} = 100\text{ mV}$ , $V_{CC} = 12\text{ V}$ , $V_{RS+} = 2\text{ V}$
		$\pm 1.0$	$\pm 5.0$	%	$V_{SENSE} = 100\text{ mV}$ , $V_{CC} = 12\text{ V}$ , $V_{RS+} = 12\text{ V}$ , $T_A = +25^\circ\text{C}$
			$\pm 5.0$	%	$V_{SENSE} = 100\text{ mV}$ , $V_{CC} = 12\text{ V}$ , $V_{RS} = 12\text{ V}$ , $T_A = -40^\circ\text{C to } +125^\circ\text{C}$
		$\pm 1.0$	$\pm 5.0$	%	$V_{SENSE} = 100\text{ mV}$ , $V_{CC} = 28\text{ V}$ , $V_{RS} = 28\text{ V}$ , $T_A = +25^\circ\text{C}$
			$\pm 5.0$	%	$V_{SENSE} = 100\text{ mV}$ , $V_{CC} = 28\text{ V}$ , $V_{RS} = 28\text{ V}$ , $T_A = -40^\circ\text{C to } +125^\circ\text{C}$
		$\pm 7.5$		%	$V_{SENSE} = 6.25\text{ mV}$ , <sup>3</sup> $V_{CC} = 12\text{ V}$ , $V_{RS} = 12\text{ V}$
Extrapolated Input Offset Voltage, $V_{OS}$		1.0		mV	$V_{CC} = V_{RS+} = 12\text{ V}$ , $V_{SENSE} > 10\text{ mV}$
Output High Voltage ( $V_{CC} - V_{OH}$ )		0.8	1.2	V	$V_{CC} = 3\text{ V}$ , $V_{SENSE} = 150\text{ mV}$ (ADM4073T)
		0.8	1.2	V	$V_{CC} = 7.5\text{ V}$ , $V_{SENSE} = 150\text{ mV}$ (ADM4073F)
		0.8	1.2	V	$V_{CC} = 15\text{ V}$ , $V_{SENSE} = 150\text{ mV}$ (ADM4073H), $T_A = 25^\circ\text{C}$
<b>DYNAMIC CHARACTERISTICS</b>					
Bandwidth, BW		1.8		MHz	$V_{SENSE} = 100\text{ mV}$ , $V_{CC} = 12\text{ V}$ , $V_{RS+} = 12\text{ V}$ , $C_{LOAD} = 5\text{ pF}$ (ADM4073T)
		1.7		MHz	$V_{SENSE} = 100\text{ mV}$ , $V_{CC} = 12\text{ V}$ , $V_{RS+} = 12\text{ V}$ , $C_{LOAD} = 5\text{ pF}$ (ADM4073F)
		1.6		MHz	$V_{SENSE} = 100\text{ mV}$ , $V_{CC} = 12\text{ V}$ , $V_{RS+} = 12\text{ V}$ , $C_{LOAD} = 5\text{ pF}$ (ADM4073H)
Gain, $A_V$		600		kHz	$V_{SENSE} = 6.25\text{ mV}$ , <sup>3</sup> $V_{CC} = 12\text{ V}$ , $V_{RS+} = 12\text{ V}$ , $C_{LOAD} = 5\text{ pF}$ (ADM4073T/F/H)
		20		V/V	ADM4073T
		50		V/V	ADM4073F
Gain Accuracy		100		V/V	ADM4073H
		$\pm 1.0$	$\pm 2.0$	%	$V_{SENSE} = 10\text{ mV to } 150\text{ mV}$ , $V_{CC} = 12\text{ V}$ , $V_{RS+} = 12\text{ V}$ , $T_A = +25^\circ\text{C}$ (ADM4073T/F)
			$\pm 2.0$	%	$V_{SENSE} = 10\text{ mV to } 150\text{ mV}$ , $V_{CC} = 12\text{ V}$ , $V_{RS+} = 12\text{ V}$ , $T_A = -40^\circ\text{C to } +125^\circ\text{C}$ (ADM4073T/F)
OUT Settling Time to 1% of Final Value		$\pm 1.0$	$\pm 1.5$	%	$V_{SENSE} = 10\text{ mV to } 100\text{ mV}$ , $V_{CC} = 12\text{ V}$ , $V_{RS+} = 12\text{ V}$ , $T_A = +25^\circ\text{C}$ (ADM4073H)
			$\pm 3.0$	%	$V_{SENSE} = 10\text{ mV to } 100\text{ mV}$ , $V_{CC} = 12\text{ V}$ , $V_{RS+} = 12\text{ V}$ , $T_A = -40^\circ\text{C to } +125^\circ\text{C}$ (ADM4073H)
		400		ns	$V_{SENSE} = 6.25\text{ mV to } 100\text{ mV}$ , $V_{CC} = 12\text{ V}$ , $V_{RS+} = 12\text{ V}$ , $C_{LOAD} = 5\text{ pF}$
Output Resistance, $R_{OUT}$		800		ns	$V_{SENSE} = 100\text{ mV to } 6.25\text{ mV}$ , $V_{CC} = 12\text{ V}$ , $V_{RS+} = 12\text{ V}$ , $C_{LOAD} = 5\text{ pF}$
		12		k $\Omega$	
Power Supply Rejection Ratio, PSRR		78		dB	$V_{SENSE} = 60\text{ mV}$ , $V_{CC} = 3\text{ V to } 28\text{ V}$ (ADM4073T)
		85		dB	$V_{SENSE} = 24\text{ mV}$ , $V_{CC} = 3\text{ V to } 28\text{ V}$ (ADM4073F)
		90		dB	$V_{SENSE} = 12\text{ mV}$ , $V_{CC} = 3\text{ V to } 28\text{ V}$ (ADM4073H)
Power-Up Time <sup>4</sup>		5		$\mu\text{s}$	$C_{LOAD} = 5\text{ pF}$ , $V_{SENSE} = 100\text{ mV}$
Saturation Recovery Time <sup>5</sup>		5		$\mu\text{s}$	$C_{LOAD} = 5\text{ pF}$ , $V_{CC} = 12\text{ V}$ , $V_{RS+} = 12\text{ V}$

<sup>1</sup> 100% production tested at  $T_A = 25^\circ\text{C}$ . Specifications over temperature limit are guaranteed by design.

<sup>2</sup> The sum of the gain and offset errors is the total OUT voltage error.

<sup>3</sup>  $6.25\text{ mV} = 1/16^{\text{th}}$  of  $100\text{ mV}$  full-scale sense voltage.

<sup>4</sup> Output settles to within 1% of final value.

<sup>5</sup> When overdriven, this device does not experience phase reversal.

## ABSOLUTE MAXIMUM RATINGS

Table 2.

Parameter	Rating
V <sub>CC</sub> to GND	−0.3 V to +30 V
RS+, RS− to GND	−0.3 V to +30 V
OUT to GND	−0.3 V to (V <sub>CC</sub> + 0.3 V)
OUT Short-Circuit to GND	Continuous
Differential Input Voltage (V <sub>RS+</sub> − V <sub>RS−</sub> )	±5 V
Current into Any Pin	±20 mA
Storage Temperature Range	−65°C to +125°C
Operating Temperature Range	−40°C to +125°C
Lead Temperature, Soldering (10 sec)	300°C
Junction Temperature	150°C

Stresses above those listed under Absolute Maximum Ratings may cause permanent damage to the device. This is a stress rating only; functional operation of the device at these or any other conditions above those indicated in the operational section of this specification is not implied. Exposure to absolute maximum rating conditions for extended periods may affect device reliability.

## THERMAL CHARACTERISTICS

$\theta_{JA}$  is specified for the worst-case conditions, that is, a device soldered in a circuit board for surface-mount packages.

Table 3. Thermal Resistance

Package Type	$\theta_{JA}$	Unit
6-Lead SOT-23	169.5	°C/W

## ESD CAUTION



**ESD (electrostatic discharge) sensitive device.** Charged devices and circuit boards can discharge without detection. Although this product features patented or proprietary protection circuitry, damage may occur on devices subjected to high energy ESD. Therefore, proper ESD precautions should be taken to avoid performance degradation or loss of functionality.

## PIN CONFIGURATION AND FUNCTION DESCRIPTIONS

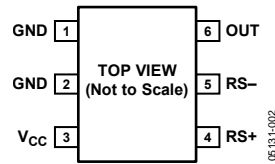

Figure 3. Pin Configuration

Table 4. Pin Function Descriptions

Pin No.	Mnemonic	Description
1	GND	Chip Ground Pin.
2	GND	Chip Ground Pin.
3	V <sub>CC</sub>	Chip Power Supply. Requires a 0.1 $\mu$ F capacitor to ground.
4	RS+	Power-Side Connection to the External Sense Resistor.
5	RS-	Load-Side Connection to the External Sense Resistor.
6	OUT	Voltage Output. V <sub>OUT</sub> is proportional to V <sub>SENSE</sub> . Output impedance is approximately 12 k $\Omega$ .

## TYPICAL PERFORMANCE CHARACTERISTICS

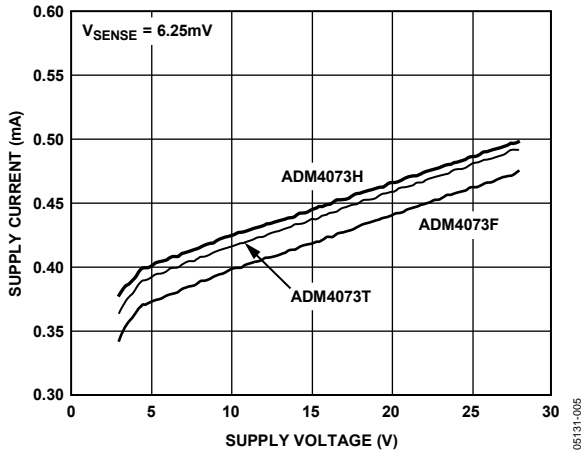

Figure 4. Supply Current vs. Supply Voltage ( $V_{SENSE} = 6.25\text{ mV}$ )

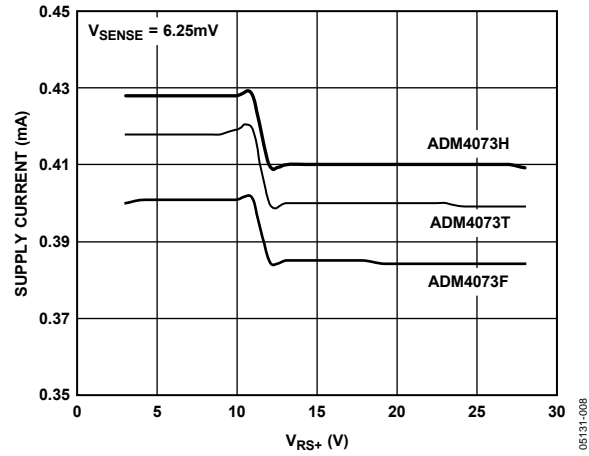

Figure 7. Supply Current vs.  $R_{S+}$  Voltage ( $V_{SENSE} = 6.25\text{ mV}$ )

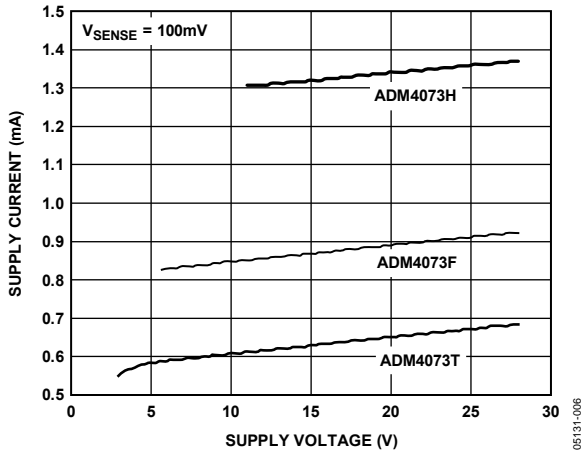

Figure 5. Supply Current vs. Supply Voltage ( $V_{SENSE} = 100\text{ mV}$ )

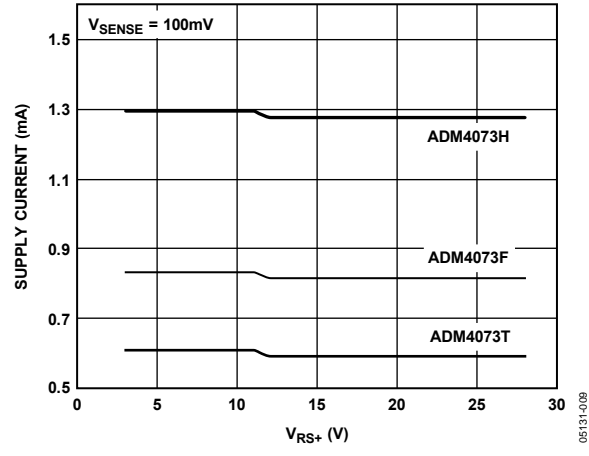

Figure 8. Supply Current vs.  $R_{S+}$  Voltage ( $V_{SENSE} = 100\text{ mV}$ )

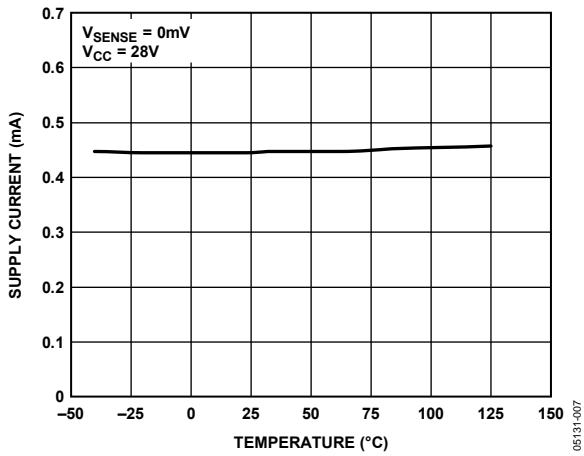

Figure 6. Supply Current vs. Temperature

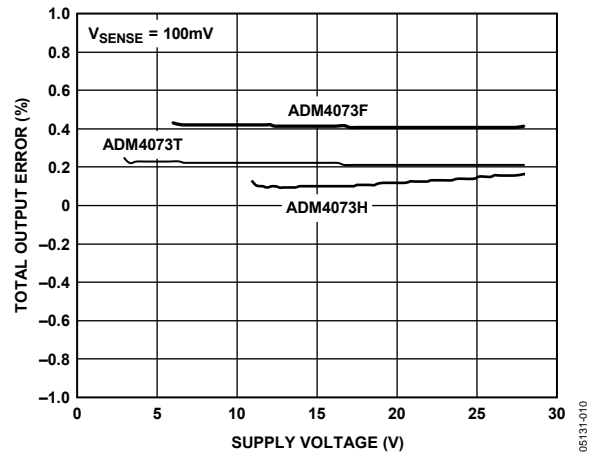

Figure 9. Total Output Error vs. Supply Voltage ( $V_{SENSE} = 100\text{ mV}$ )

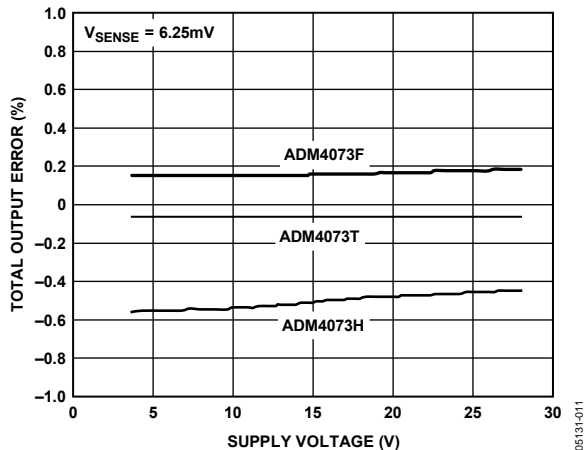

Figure 10. Total Output Error vs. Supply Voltage ( $V_{SENSE} = 6.25\text{ mV}$ )

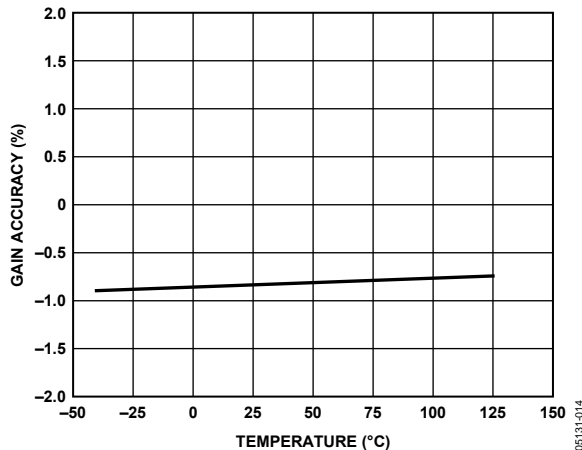

Figure 13. Gain Accuracy vs. Temperature

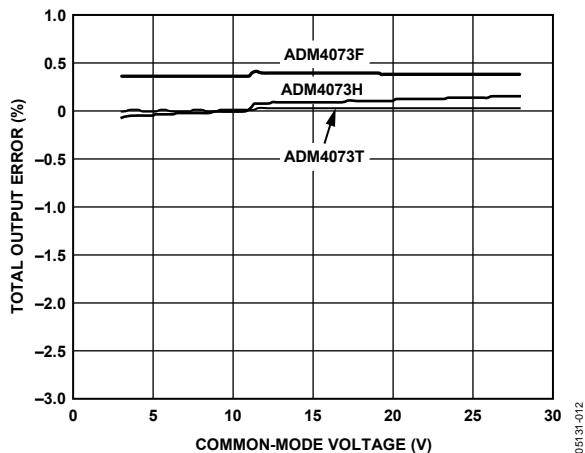

Figure 11. Total Output Error vs. Common-Mode Voltage

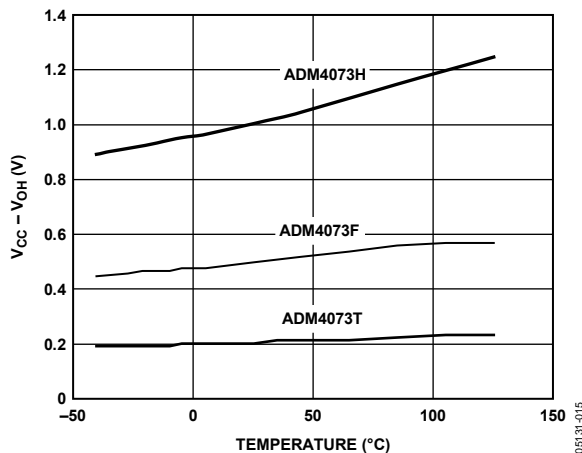

Figure 14. Output High Voltage ( $V_{CC} - V_{OH}$ ) vs. Temperature

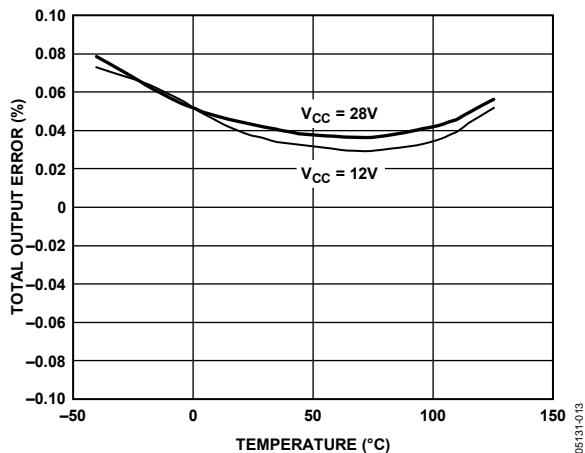

Figure 12. Total Output Error vs. Temperature

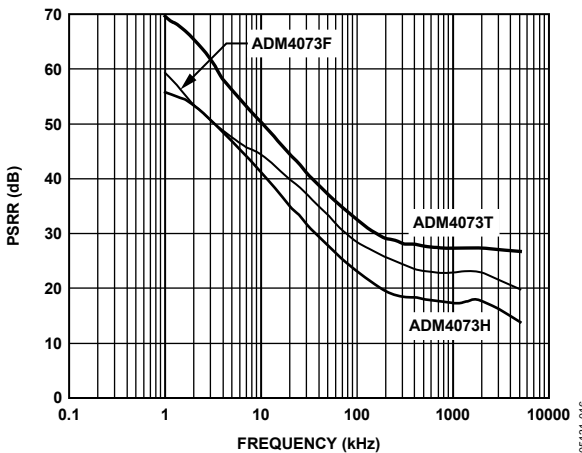

Figure 15. PSRR vs. Frequency

# ADM4073



Figure 16. Small Signal Gain vs. Frequency



Figure 19. ADM4073H Small Signal Transient Response

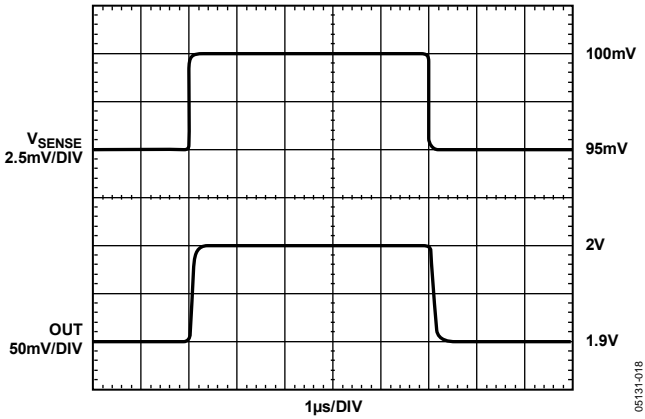

Figure 17. ADM4073T Small Signal Transient Response

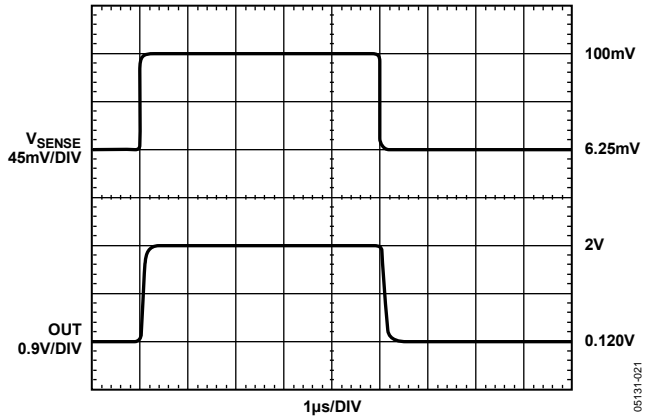

Figure 20. ADM4073T Large Signal Transient Response

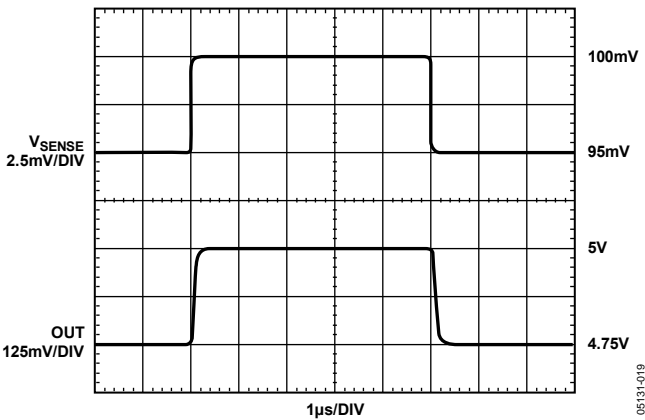

Figure 18. ADM4073F Small Signal Transient Response

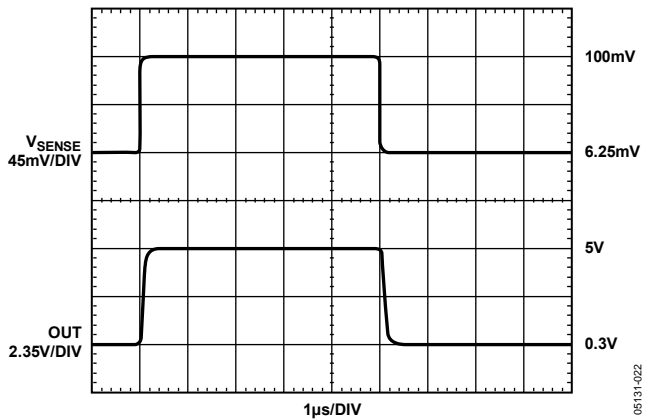

Figure 21. ADM4073F Large Signal Transient Response



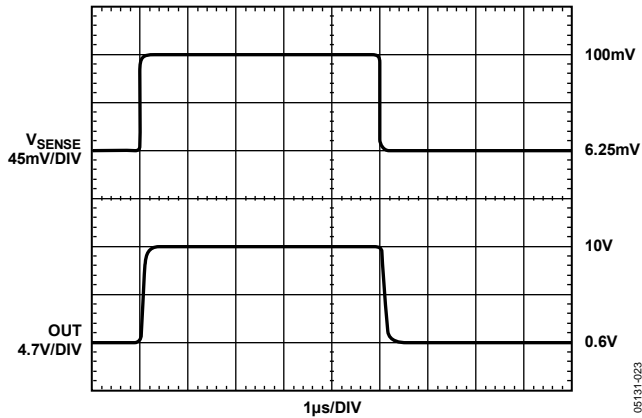

Figure 22. ADM4073H Large Signal Transient Response

05131-023

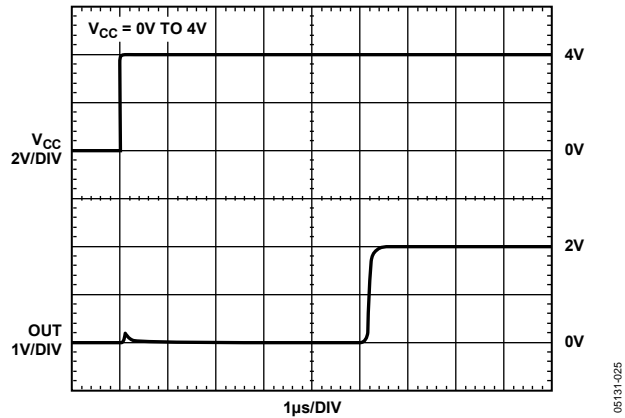

Figure 24. ADM4073T Start-Up Delay

05131-025

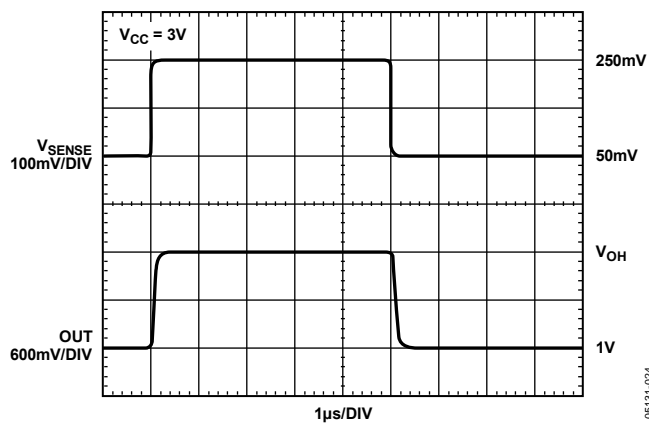

Figure 23. ADM4073T Overdrive Response

05131-024

## THEORY OF OPERATION

The current from the source flows through  $R_{SENSE}$ , which generates a voltage drop,  $V_{SENSE}$ , across the  $RS+$  and  $RS-$  terminals of the sense amplifier. The Input Stage Amplifier A1 regulates its inputs to be equal, thereby shunting a current proportional to  $V_{SENSE}/R_{G1}$  to the output current mirror. This current is then multiplied by a gain factor of  $b$  in the output stage current mirror and flows through  $R_{GD}$  to generate  $V_{OUT}$ . Therefore,  $V_{OUT}$  is related to  $V_{SENSE}$  by the ratio of  $R_{G1}$  to  $R_{GD}$  and the current gain of  $b$ .

$$V_{OUT} = A_V \times V_{SENSE}$$

where:

$$A_V = R_{GD}/R_{G1} \times b$$

$A_V$  is equal to different voltages depending upon the model of the device.

- 20 V/V for ADM4073T.
- 50 V/V for ADM4073F.
- 100 V/V for ADM4073H.

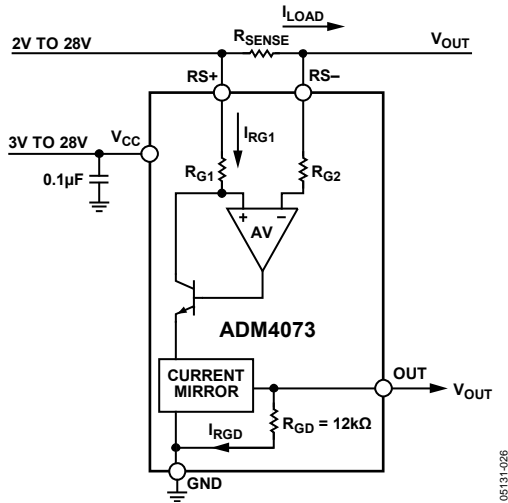

Figure 25. Functional Block Diagram

### $R_{SENSE}$

The ADM4073 has the ability to sense a wide variety of currents by selecting a particular sense resistor. Select a suitable output voltage for full-scale current, such as 10 V for 10 A. Then, select a gain model that gives the most efficient use of the sense voltage range (150 mV max).

In the example above, using the ADM4073H (gain of 100) gives an output voltage of 10 V when the sense voltage is 100 mV. Use the following equation to determine what value of sense resistor gives 100 mV with 10 A flowing through it:

$$R_{SENSE} = 100 \text{ mV}/10 \text{ A}$$

$$R_{SENSE} = 10 \text{ m}\Omega$$

$$V_{OUT} = (I_{LOAD} \times R_{SENSE}) \times A_V$$

To measure lower currents accurately, use as large a sense resistor as possible to utilize the higher end of the sense voltage range. This reduces the effects of the offset voltage errors in the internal amplifier.

When currents are very large, it is important to take the  $I^2R$  power losses across the sense resistor into account. If the sense resistor's rated power dissipation is not sufficient, its value can drift, giving an inaccurate output voltage or it could fail altogether. This, in turn, causes the voltage across the  $RS+$  and  $RS-$  pins to exceed the absolute maximum ratings.

If the monitored supply rail has a large amplitude high frequency component, choose a sense resistor with low inductance.

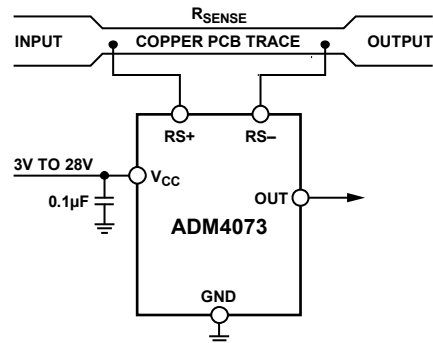

Figure 26. Using PCB Trace for Current Sensing

### OUTPUT (OUT)

The output stage of the ADM4073 is a current source driving a pull-down resistance. To ensure optimum accuracy, care must be taken not to load this output externally. To minimize output errors, ensure OUT is connected to a high impedance input stage. If this is not possible, output buffering is recommended.

The percent error introduced by output loading is determined with the following formula:

$$\% \text{ Error} = 100 \left( 1 - R_{LOAD} / (R_{OUT\_INT} + R_{LOAD}) \right)$$

where:

$R_{LOAD}$  is the external load applied to OUT.

$R_{OUT\_INT}$  is the internal output resistance (12 kΩ).

## OUTLINE DIMENSIONS

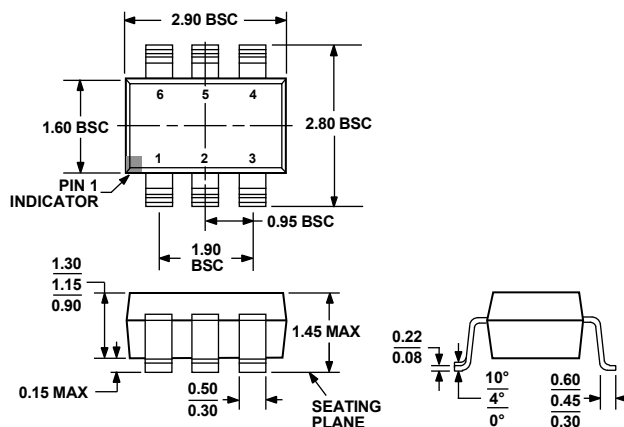

COMPLIANT TO JEDEC STANDARDS MO-178-AB

Figure 27. 6-Lead Small Outline Transistor Package [SOT-23] (RJ-6)

Dimensions shown in millimeters

## ORDERING GUIDE

Model	Gain	Temperature Range	Package Description	Package Option	Branding
ADM4073TWRJZ-REEL <sup>1</sup>	20	-40°C to +125°C	6-Lead SOT-23	RJ-6	M2E
ADM4073FWRJZ-REEL <sup>1</sup>	50	-40°C to +125°C	6-Lead SOT-23	RJ-6	M2C
ADM4073HWRJZ-REEL <sup>1</sup>	100	-40°C to +125°C	6-Lead SOT-23	RJ-6	M2D
ADM4073WFWRJZ-RL <sup>1, 2</sup>	50	-40°C to +125°C	6-Lead SOT-23	RJ-6	M2C

<sup>1</sup> Z = RoHS Compliant Part.

<sup>2</sup> Automotive Grade.

**ADM4073**

**NOTES**

## Данный компонент на территории Российской Федерации

### Вы можете приобрести в компании MosChip.

Для оперативного оформления запроса Вам необходимо перейти по данной ссылке:

<http://moschip.ru/get-element>

Вы можете разместить у нас заказ для любого Вашего проекта, будь то серийное производство или разработка единичного прибора.

В нашем ассортименте представлены ведущие мировые производители активных и пассивных электронных компонентов.

Нашей специализацией является поставка электронной компонентной базы двойного назначения, продукции таких производителей как XILINX, Intel (ex.ALTERA), Vicor, Microchip, Texas Instruments, Analog Devices, Mini-Circuits, Amphenol, Glenair.

Сотрудничество с глобальными дистрибьюторами электронных компонентов, предоставляет возможность заказывать и получать с международных складов практически любой перечень компонентов в оптимальные для Вас сроки.

На всех этапах разработки и производства наши партнеры могут получить квалифицированную поддержку опытных инженеров.

Система менеджмента качества компании отвечает требованиям в соответствии с ГОСТ Р ИСО 9001, ГОСТ РВ 0015-002 и ЭС РД 009

### Офис по работе с юридическими лицами:

105318, г.Москва, ул.Щербаковская д.3, офис 1107, 1118, ДЦ «Щербаковский»

Телефон: +7 495 668-12-70 (многоканальный)

Факс: +7 495 668-12-70 (доб.304)

E-mail: [info@moschip.ru](mailto:info@moschip.ru)

Skype отдела продаж:

moschip.ru

moschip.ru\_4

moschip.ru\_6

moschip.ru\_9