

9mm Rotary Type, Snap-In, Insulated Shaft

Application

- ✓ TV/Video, Audio, Home appliance, Industrial control

Feature

- ✓ Smooth rotation feeling



■Specification

Total Rotational Angle	RV09A series: 280±5° , RV09B series: 300±5°
Maximum Operating Voltage	50V AC
Insulation Resistance	100MΩ at DC250V
Dielectric Strength	AC250V for 1 minute
Rotational Torque	10-100 gf.cm
Click Torque	20-120 gf.cm
Rotational Stop Strength of the Shaft	3 kgs.cm min
Push/Pull Strength of the Shaft	5kgs for 3 sec
Operating Temperature Range	-10 °C~70°C
Rotation Life	With click: 5,000 cycles, without click: 10,000 cycles

■How to order

RV09AF-20 – 15F - B10K - 0C

[Model](#)

[Shaft Type](#)

Taper and Resistance Value

Order Code	Taper	Resistance Value
A100K	Log/A	100KΩ
B1M	Linear/B	1MΩ
C500K	Rev-log/C	500KΩ

Taper: A, B and C

Resistance Value: 1KΩ to 500KΩ and 1MΩ

*Contact us for other requirements.

Click

Order Code	Description
Blank	No click
0C	With center click





9mm Rotary Type, Snap-In, Insulated Shaft

■ Model Description

Model	Number of Unit	Terminal Type	With Sleeve or Bushing	Rotational Angle	Mounting Height
RV09ACF-20	Single unit	Horizontal	Sleeve	280°±5°	10 mm
RV09BCF-20	Single unit	Horizontal	Sleeve	300°±5°	10 mm
RV09ACF-40	Single unit	Vertical	Sleeve	280°±5°	7.0 mm
RV09BCF-40	Single unit	Vertical	Sleeve	300°±5°	7.0 mm
RV09AF-20	Single unit	Horizontal	N/A	280°±5°	10 mm
RV09AF-21	Single unit	Horizontal	N/A	280°±5°	6.5 mm
RV09BF-20	Single unit	Horizontal	N/A	300°±5°	10 mm
RV09BF-21	Single unit	Horizontal	N/A	300°±5°	6.5 mm
RV09AF-40	Single unit	Vertical	N/A	280°±5°	7.0 mm
RV09BF-40	Single unit	Vertical	N/A	300°±5°	7.0 mm
RV09AF-20E1N	Single unit	Horizontal	Plastic bushing	280°±5°	10 mm
RV09AF-21E1N	Single unit	Horizontal	Plastic bushing	280°±5°	6.5 mm
RV09BF-20E1N	Single unit	Horizontal	Plastic bushing	300°±5°	10 mm
RV09BF-21E1N	Single unit	Horizontal	Plastic bushing	300°±5°	6.5 mm
RV09AF-40E1N	Single unit	Vertical	Plastic bushing	280°±5°	7.0 mm
RV09BF-40E1N	Single unit	Vertical	Plastic bushing	300°±5°	7.0 mm
RV09AF-20E1	Single unit	Horizontal	Metal bushing	280°±5°	10 mm
RV09BF-20E1	Single unit	Horizontal	Metal bushing	300°±5°	10 mm
RV09AF-21E1	Single unit	Horizontal	Metal bushing	280°±5°	6.5 mm
RV09BF-21E1	Single unit	Horizontal	Metal bushing	300±5°	6.5 mm
RV09AF-40E1	Single unit	Vertical	Metal bushing	280°±5°	7.0 mm
RV09BF-40E1	Single unit	Vertical	Metal bushing	300°±5°	7.0 mm

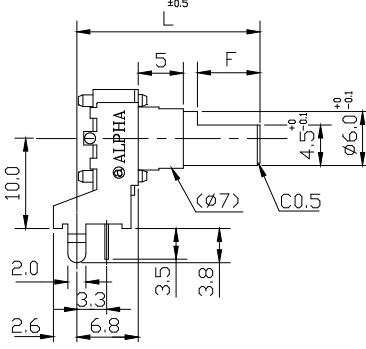
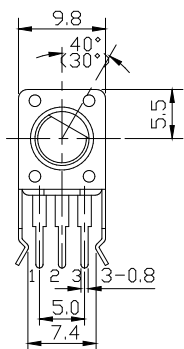
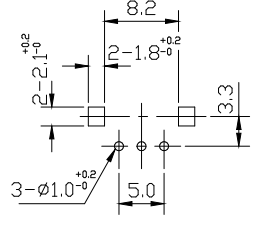
[Back to top](#)

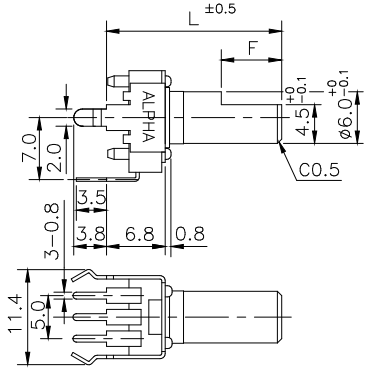
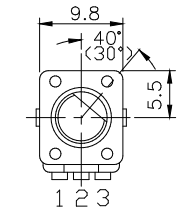
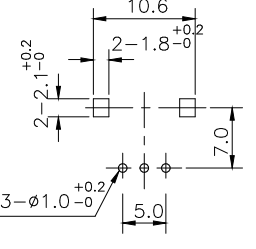
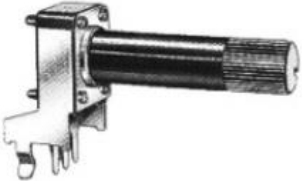
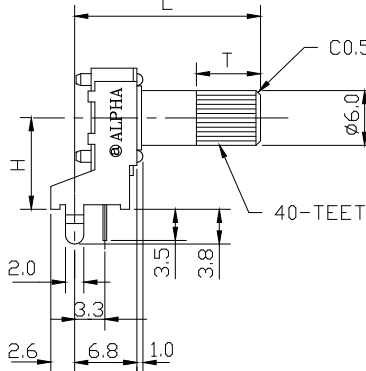
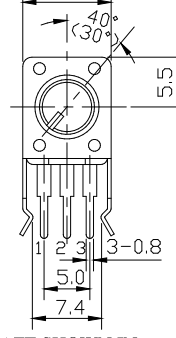
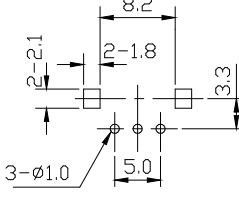
9mm Rotary Type, Snap-In, Insulated Shaft

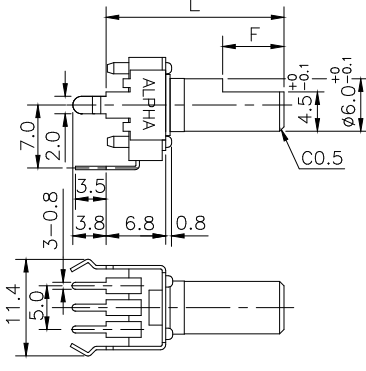
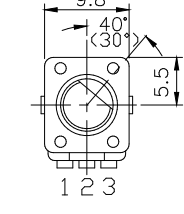
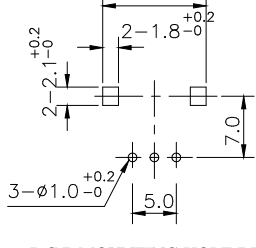





Order Code	Outline Drawing								
RV09ACF-20 RV09BCF-20 		SHAFT SHOWN IN FULL C.C.W. POSITION 	 P.C.B.MOUNTING HOLE DETAIL						
RV09ACF-40 RV09BCF-40 		SHAFT SHOWN IN FULL C.C.W. POSITION 	 P.C.B.MOUNTING HOLE DETAIL						
RV09AF-20,RV09BF-20 RV09AF-21,RV09BF-21 		SHAFT SHOWN IN FULL C.C.W. POSITION 	 P.C.B.MOUNTING HOLE DETAIL <table border="1" data-bbox="1228 1489 1492 1579"> <thead> <tr> <th>MODEL</th> <th>H</th> </tr> </thead> <tbody> <tr> <td>RV09A(B)-20</td> <td>10.0</td> </tr> <tr> <td>RV09A(B)-21</td> <td>6.5</td> </tr> </tbody> </table>	MODEL	H	RV09A(B)-20	10.0	RV09A(B)-21	6.5
MODEL	H								
RV09A(B)-20	10.0								
RV09A(B)-21	6.5								
RV09AF-40 RV09BF-40 		SHAFT SHOWN IN FULL C.C.W. POSITION 	 P.C.B.MOUNTING HOLE DETAIL						

[Back to top](#)

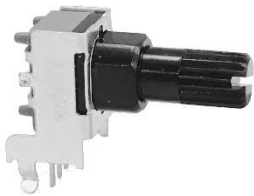
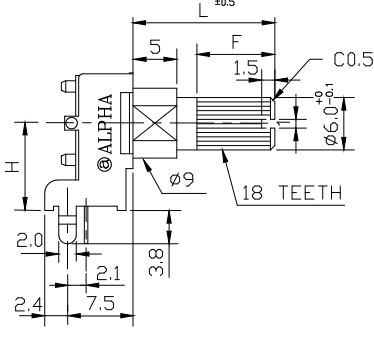
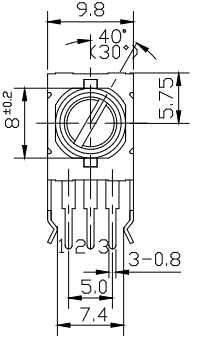
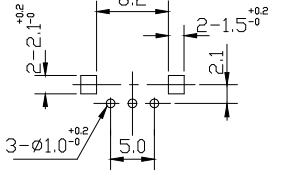
POTENTIOMETERS

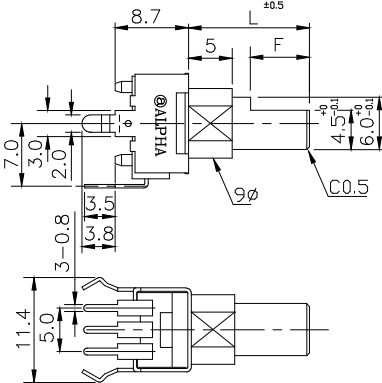
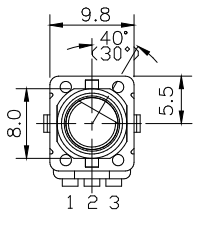
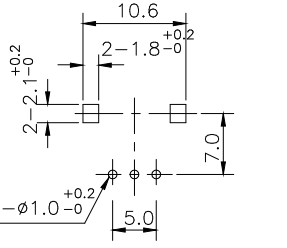

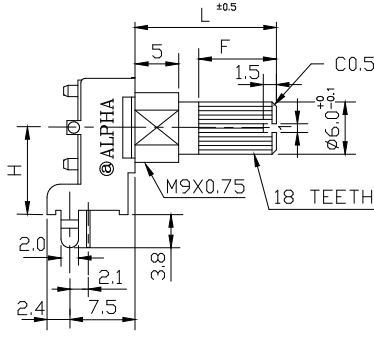
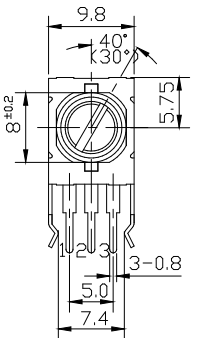
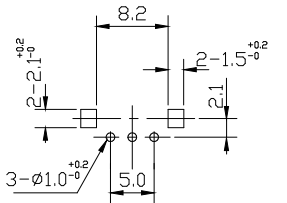
9mm Rotary Type, Snap-In, Insulated Shaft

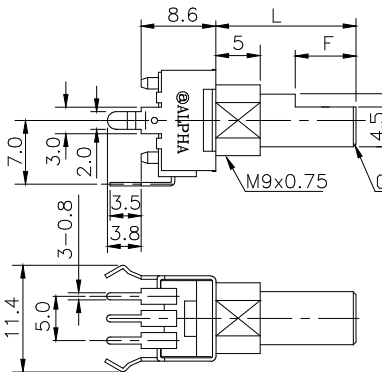
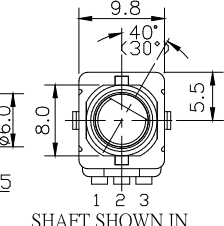
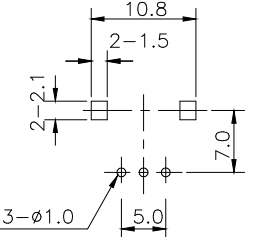
Order code	Outline Drawing							
RV09AF-20E1N, RV09AF-21E1N RV09BF-20E1N, RV09BF-21E1N 		<p>SHAFT SHOWN IN FULL C.C.W. POSITION</p>  <p>P.C.B. MOUNTING HOLE DETAIL</p>  <table border="1" data-bbox="1220 638 1492 728"> <thead> <tr> <th>MODEL</th> <th>H</th> </tr> </thead> <tbody> <tr> <td>RV09A(B)-20E1N</td> <td>10.0</td> </tr> <tr> <td>RV09A(B)-21E1N</td> <td>6.5</td> </tr> </tbody> </table>	MODEL	H	RV09A(B)-20E1N	10.0	RV09A(B)-21E1N	6.5
MODEL	H							
RV09A(B)-20E1N	10.0							
RV09A(B)-21E1N	6.5							
RV09AF-40E1N RV09BF-40E1N 		<p>SHAFT SHOWN IN FULL C.C.W. POSITION</p>  <p>P.C.B. MOUNTING HOLE DETAIL</p> 						
RV09AF-20E1, RV09BF-20E1 RV09AF-21E1, RV09BF-21E1 		<p>SHAFT SHOWN IN FULL C.C.W. POSITION</p>  <p>P.C.B. MOUNTING HOLE DETAIL</p>  <table border="1" data-bbox="1220 1489 1476 1579"> <thead> <tr> <th>MODEL</th> <th>H</th> </tr> </thead> <tbody> <tr> <td>RV09A(B)-20E1</td> <td>10.0</td> </tr> <tr> <td>RV09A(B)-21E1</td> <td>6.5</td> </tr> </tbody> </table>	MODEL	H	RV09A(B)-20E1	10.0	RV09A(B)-21E1	6.5
MODEL	H							
RV09A(B)-20E1	10.0							
RV09A(B)-21E1	6.5							
RV09AF-40E1 RV09BF-40E1 		<p>SHAFT SHOWN IN FULL C.C.W. POSITION</p>  <p>P.C.B. MOUNTING HOLE DETAIL</p> 						

[Back to top](#)

9mm Rotary Type, Snap-In, Insulated Shaft

■ K TYPE

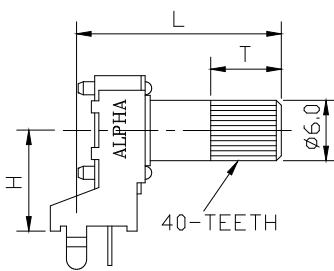
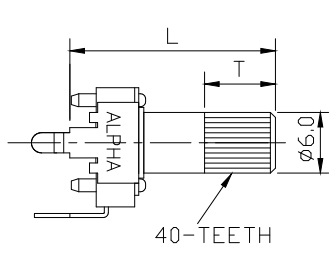
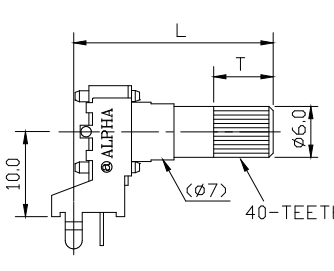
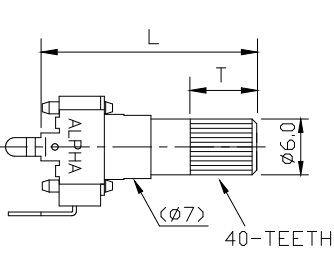
RV09AF-20(21)-(L)K RV09BF-20(21)-(L)K	RV09AF-40-(L)K RV09BF-40-(L)K	RV09ACF-20-(L)K RV09BCF-20-(L)K	RV09ACF-40-(L)K RV09BCF-40-(L)K
			

RV09AF, RV09ACF

Order Code	15K	20K	25K	30K
L	15	20	25	30
T	7	7	7	7

RV09BF, RV09BCF

Order Code	20K	25K	30K
L	20	25	30
T	7	7	7

**15 mm shaft is not available for RV09ACF/BCF models.

RV09AF-20E1N(21E1N)-(L)K
RV09BF-20E1N(21E1N)-(L)K
RV09AF-20E1(21E1)-(L)K
RV09BF-20E1(21E1)-(L)K

RV09AF-40E1N-(L)K
RV09BF-40E1N-(L)K
RV09AF-40E1-(L)K
RV09BF-40E1-(L)K

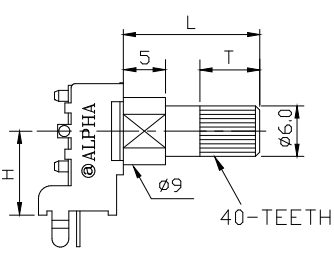
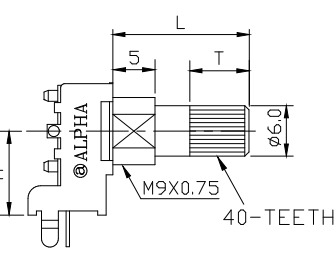
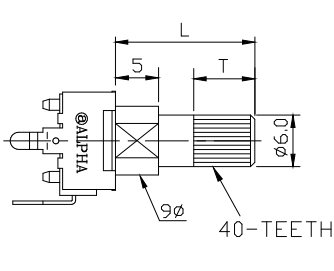
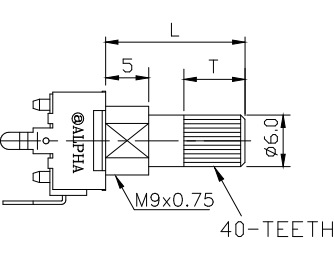
			
--	---	--	---

Order Code	165K	25K
L	16.5	21.5
T	7	7

[Back to top](#)

9mm Rotary Type, Snap-In, Insulated Shaft

■ F TYPE

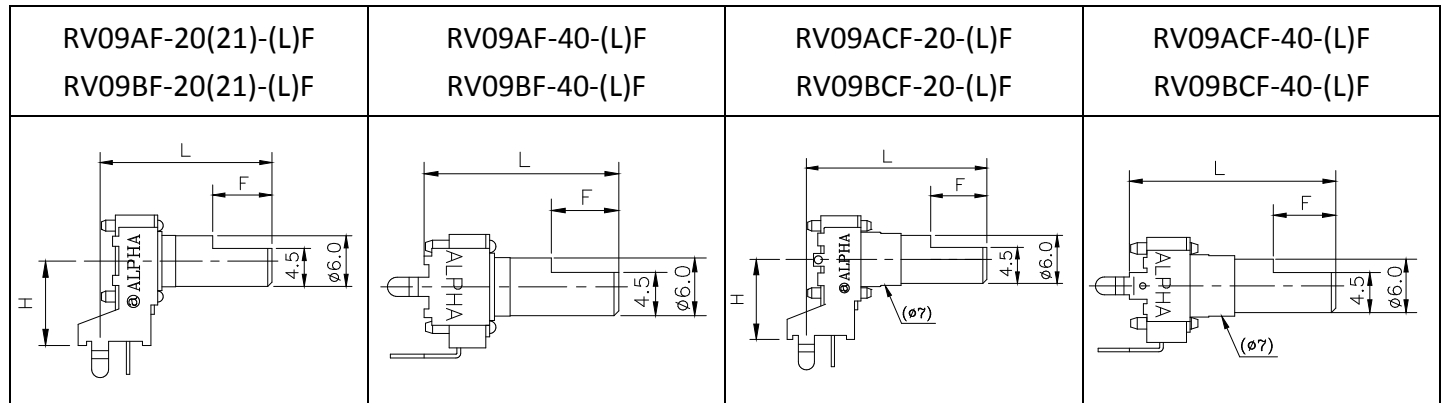

RV09AF, RV09ACF

Order Code	*15F	20F	21F	25F	26F	30F	31F	375F
L	15	20	21	25	26	30	31	37.5
F	6	7	7	7	12	12	12	12

RV09BF, RV09BCF

Order Code	*15F	20F	21F	235F	25F	26F	30F	31F	335F	35F	375F
L	15	20	21	23.5	25	26	30	31	33.5	35	37.5
F	6	7	7	7	7	8.25	12	12	12	12	12

**15 mm shaft is not available for RV09ACF/BCF models.

RV09AF-20E1N(21E1N)-(L)F
 RV09BF-20E1N(21E1N)-(L)F
 RV09AF-20E1(21E1)-(L)F
 RV09BF-20E1(21E1)-(L)F

RV09AF-40E1N-(L)F
 RV09BF-40E1N-(L)F
 RV09AF-40E1-(L)F
 RV09BF-40E1-(L)F

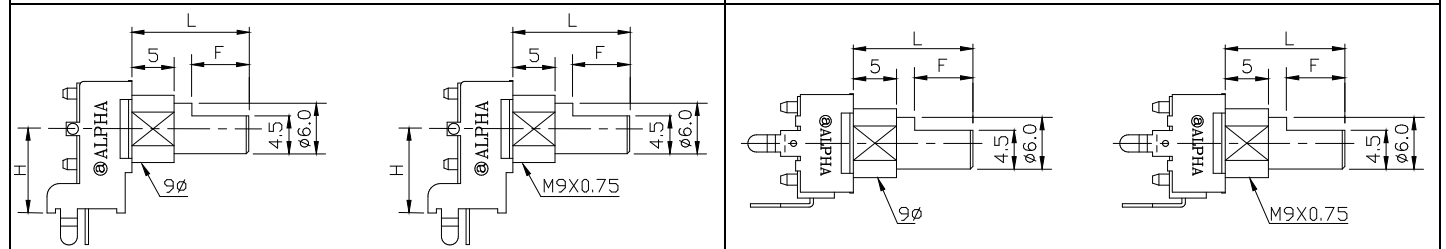

RV09AF

Order Code	115F	125F	165F	175F	215F	225F	29F
L	11.5	12.5	16.5	17.5	21.5	22.5	29
F	7	7	7	12	12	12	12

RV09BF

Order Code	115F	125F	15F	165F	165F	165F	175F	215F	225F	25F	265F	29F
L	11.5	12.5	15	16.5	16.5	16.5	17.5	21.5	22.5	25	26.5	29
F	7	7	7	7	8.25	12	12	12	12	12	12	12

[Back to top](#)

9mm Rotary Type, Snap-In, Insulated Shaft

■ B TYPE

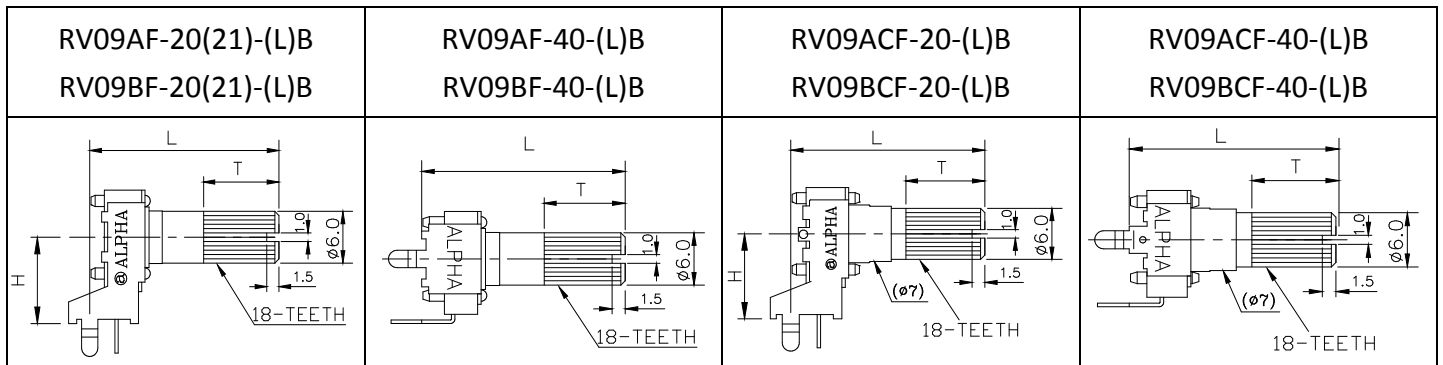

RV09AF, RV09ACF

Order Code	15B	20F	25B	30B
L	15	20	25	30
T	7	7	7	7

RV09BF, RV09BCF

Order Code	20B	25B	30B	33B
L	20	25	30	33
T	7	7	7	7

**15 mm shaft is not available for RV09ACF/BCF models.

RV09AF-20E1N(21E1N)-(L)B RV09BF-20E1N(21E1N)-(L)B RV09AF-20E1(21E1)-(L)B RV09BF-20E1(21E1)-(L)B	RV09AF-40E1N-(L)B RV09BF-40E1N-(L)B RV09AF-40E1-(L)B RV09BF-40E1-(L)B
--	--

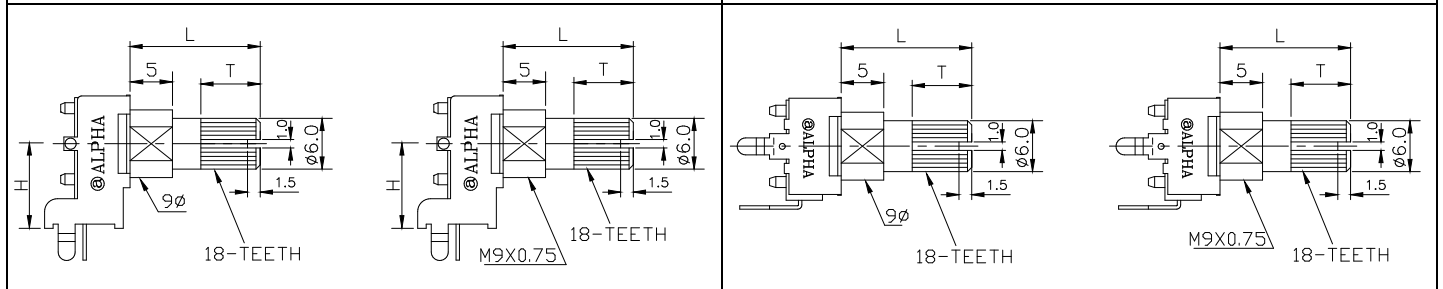

RV09AF

Order Code	115B	165B	215B
L	11.5	16.5	21.5
T	7	7	7

RV09BF

Order Code	115B	165B	215B	25B
L	11.5	16.5	21.5	25
T	7	7	7	7

Design and specifications presented here are for the standard parts only. Please kindly contact us for your special requests and ask for the current technical specifications before purchase and/or use.

[Back to top](#)

Mouser Electronics

Authorized Distributor

Click to View Pricing, Inventory, Delivery & Lifecycle Information:

Alpha (Taiwan):

[RV09AF-40-20K-A10K](#) [RV09AF-40-20K-B10K](#) [RV09AF-40-20K-A55](#) [RV09AF-20-20K-A55](#) [RV09AF-20-20K-B55](#)
[RV09AF-40-20K-B55](#) [RV09AF-40-20K-B50K](#) [RV09AF-40-20K-A54](#) [RV09AF-20-20K-B16](#) [RV09AF-20-20K-B13](#)
[RV09AF-20-20K-B53](#) [RV09AF-20-20K-B23](#) [RV09AF-40-20K-A53](#) [RV09AF-40-20K-A16](#) [RV09AF-40-20K-A13](#)
[RV09AF-40-20K-A23](#) [RV09AF-40-20K-B100K](#) [RV09AF-20-20K-B100K](#) [RV09AF-20-20K-B10K](#) [RV09AF-20-20K-A14](#)
[RV09AF-40-20K-A100K](#) [RV09AF-20-20K-A15](#) [RV09AF-20-20K-A54](#) [RV09AF-20-20K-B50K](#) [RV09AF-40-20K-B1K](#)
[RV09AF-40-20K-B1M](#) [RV09AF-40-20K-B5K](#) [RV09AF-40-20K-B23](#) [RV09AF-20-20K-A23](#) [RV09AF-20-20K-A13](#)
[RV09AF-20-20K-A53](#) [RV09AF-20-20K-A16](#) [RV09AF-20-20K-B20](#) [RV09AF-40-30K-C10K](#) [RV09AF-40-30K-C100K](#)
[RV09AF-40-30K-B500K](#) [RV09AF-40-20K-A500K](#) [RV09AF-40-30K-A10K](#) [RV09AF-40-30K-B10K](#) [RV09AF-40-30K-](#)
[B100K](#) [RV09AF-40-30K-A500K](#) [RV09AF-40-30K-B50K](#) [RV09AF-40-30K-B5K](#) [RV09AF-40-30K-B1K](#) [RV09AF-40-30K-](#)
[B1M](#) [RV09AF-40-30K-A100K](#) [RV09AF-20-20K-A10K](#) [RV09AF-20-20K-B5K](#) [RV09AF-20-20K-A1M](#) [RV09AF-20-20K-](#)
[A50K](#) [RV09AF-20-20K-A5K](#) [RV09AF-40-20K-A2K](#) [RV09AF-20-20K-A2K](#) [RV09AF-40-20K-A5K](#) [RV09AF-40-20K-B2K](#)
[RV09AF-40-20K-A1M](#)

Данный компонент на территории Российской Федерации

Вы можете приобрести в компании MosChip.

Для оперативного оформления запроса Вам необходимо перейти по данной ссылке:

<http://moschip.ru/get-element>

Вы можете разместить у нас заказ для любого Вашего проекта, будь то серийное производство или разработка единичного прибора.

В нашем ассортименте представлены ведущие мировые производители активных и пассивных электронных компонентов.

Нашей специализацией является поставка электронной компонентной базы двойного назначения, продукции таких производителей как XILINX, Intel (ex.ALTERA), Vicor, Microchip, Texas Instruments, Analog Devices, Mini-Circuits, Amphenol, Glenair.

Сотрудничество с глобальными дистрибьюторами электронных компонентов, предоставляет возможность заказывать и получать с международных складов практически любой перечень компонентов в оптимальные для Вас сроки.

На всех этапах разработки и производства наши партнеры могут получить квалифицированную поддержку опытных инженеров.

Система менеджмента качества компании отвечает требованиям в соответствии с ГОСТ Р ИСО 9001, ГОСТ РВ 0015-002 и ЭС РД 009

Офис по работе с юридическими лицами:

105318, г.Москва, ул.Щербаковская д.3, офис 1107, 1118, ДЦ «Щербаковский»

Телефон: +7 495 668-12-70 (многоканальный)

Факс: +7 495 668-12-70 (доб.304)

E-mail: info@moschip.ru

Skype отдела продаж:

moschip.ru

moschip.ru_4

moschip.ru_6

moschip.ru_9