

Analog Devices Welcomes Hittite Microwave Corporation

NO CONTENT ON THE ATTACHED DOCUMENT HAS CHANGED



THIS PAGE INTENTIONALLY LEFT BLANK



SMT GaAs MMIC x2 ACTIVE FREQUENCY MULTIPLIER, 23 - 33 GHz

Typical Applications

The HMC578LC3B is suitable for:

- Clock Generation Applications:
SONET OC-192 & SDH STM-64
- Point-to-Point & VSAT Radios
- Test Instrumentation
- Military & Space

Features

- High Output Power: +15 dBm
- Low Input Power Drive: 0 to +6 dBm
- Fo Isolation: >20 dBc @ Fout= 28 GHz
- 100 KHz SSB Phase Noise: -132 dBc/Hz
- Single Supply: +5V@ 81 mA
- RoHS Compliant 3x3 mm SMT Package

Functional Diagram

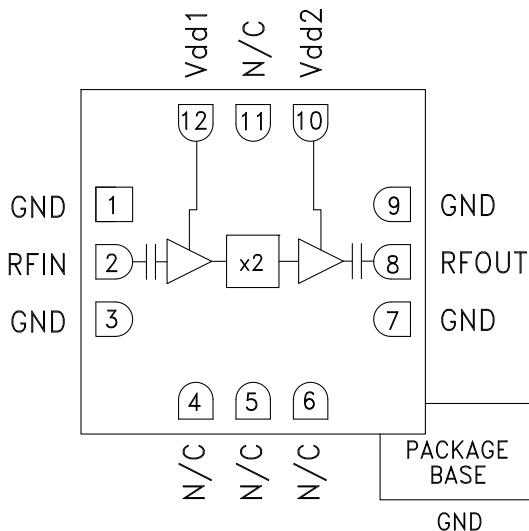

General Description

The HMC578LC3B is a x2 active broadband frequency multiplier utilizing GaAs PHEMT technology in a leadless RoHS compliant SMT package. When driven by a +3 dBm signal, the multiplier provides +15 dBm typical output power from 23 to 33 GHz. The Fo and 3Fo isolations are >20 dBc and >30 dBc respectively at 28 GHz. The HMC578LC3B is ideal for use in LO multiplier chains for Pt-to-Pt & VSAT Radios yielding reduced parts count vs. traditional approaches. The low additive SSB Phase Noise of -129 dBc/Hz at 100 kHz offset helps maintain good system noise performance. The RoHS packaged HMC578LC3B eliminates the need for wire bonding, and allows the use of surface mount manufacturing techniques.

Electrical Specifications, $T_A = +25^\circ C$, $V_{dd1}, V_{dd2} = +5V$, 3 dBm Drive Level

Parameter	Min.	Typ.	Max.	Units
Frequency Range, Input	11.5 - 16.5			GHz
Frequency Range, Output	23 - 33			GHz
Output Power	10	15		dBm
Fo Isolation (with respect to output level)		20		dBc
3Fo Isolation (with respect to output level)		30		dBc
Input Return Loss		10		dB
Output Return Loss		12		dB
SSB Phase Noise (100 kHz Offset)		-132		dBc/Hz
Supply Current (Idd1 & Idd2)		81		mA

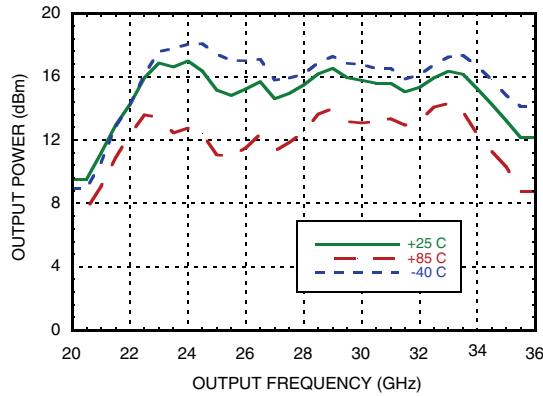
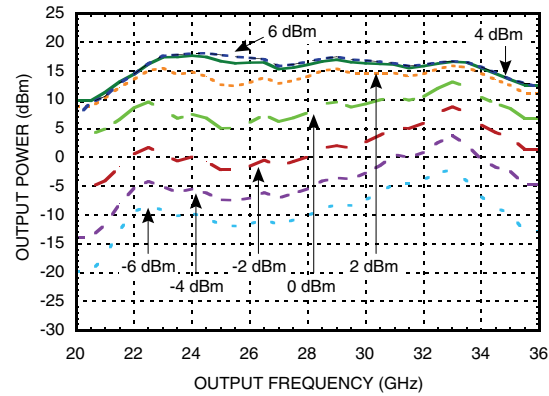
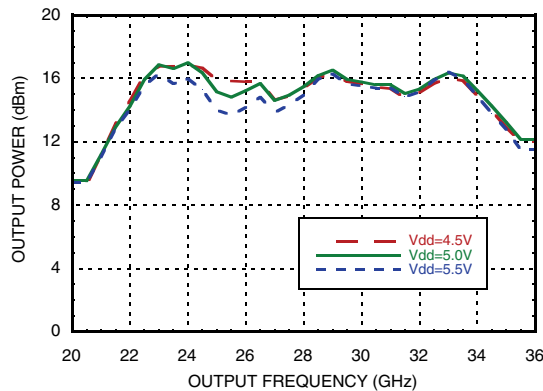
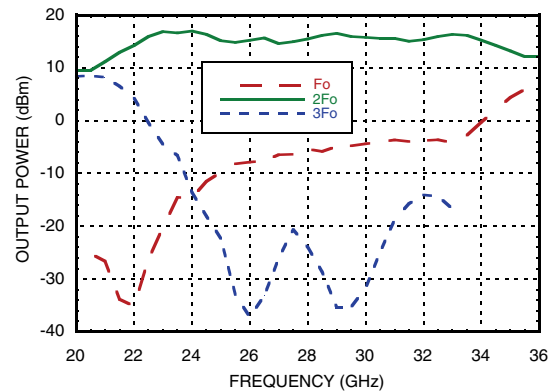
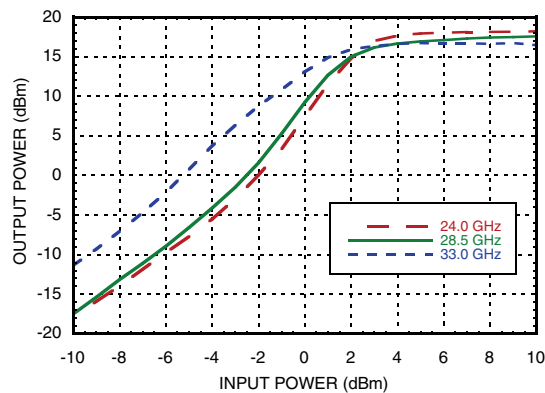
SMT GaAs MMIC x2 ACTIVE FREQUENCY MULTIPLIER, 23 - 33 GHz
Output Power vs. Temperature @ 3 dBm Drive Level

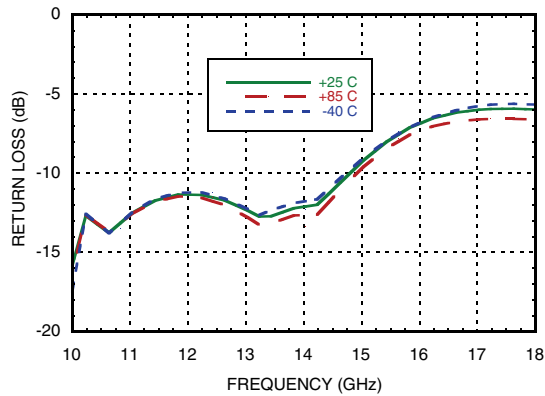
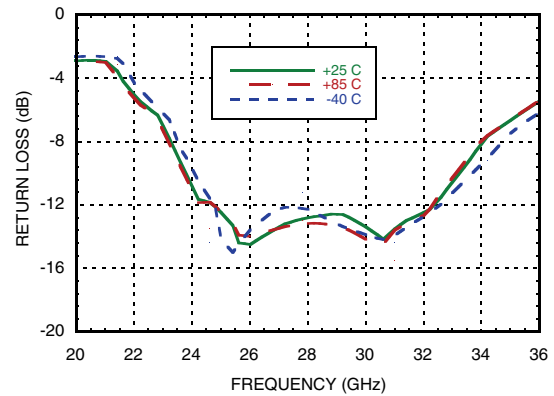
Output Power vs. Drive Level

Output Power vs. Supply Voltage @ 3 dBm Drive Level

Isolation @ 3 dBm Drive Level

Output Power vs. Input Power



SMT GaAs MMIC x2 ACTIVE FREQUENCY MULTIPLIER, 23 - 33 GHz
Input Return Loss vs. Temperature

Output Return Loss vs. Temperature

SMT GaAs MMIC x2 ACTIVE FREQUENCY MULTIPLIER, 23 - 33 GHz
Absolute Maximum Ratings

RF Input (Vdd = +5V)	+13 dBm
Supply Voltage (Vdd)	+6.0 Vdc
Channel Temperature	175 °C
Continuous Pdiss (T= 85 °C) (derate 7.4 mW/°C above 85 °C)	670 mW
Thermal Resistance (channel to ground paddle)	135 °C/W
Storage Temperature	-65 to +150 °C
Operating Temperature	-40 to +85 °C

Typical Supply Current vs. Vdd

Vdd (Vdc)	Idd (mA)
4.5	81
5.0	81
5.5	81

Note:
Multiplier will operate over full voltage range shown above.

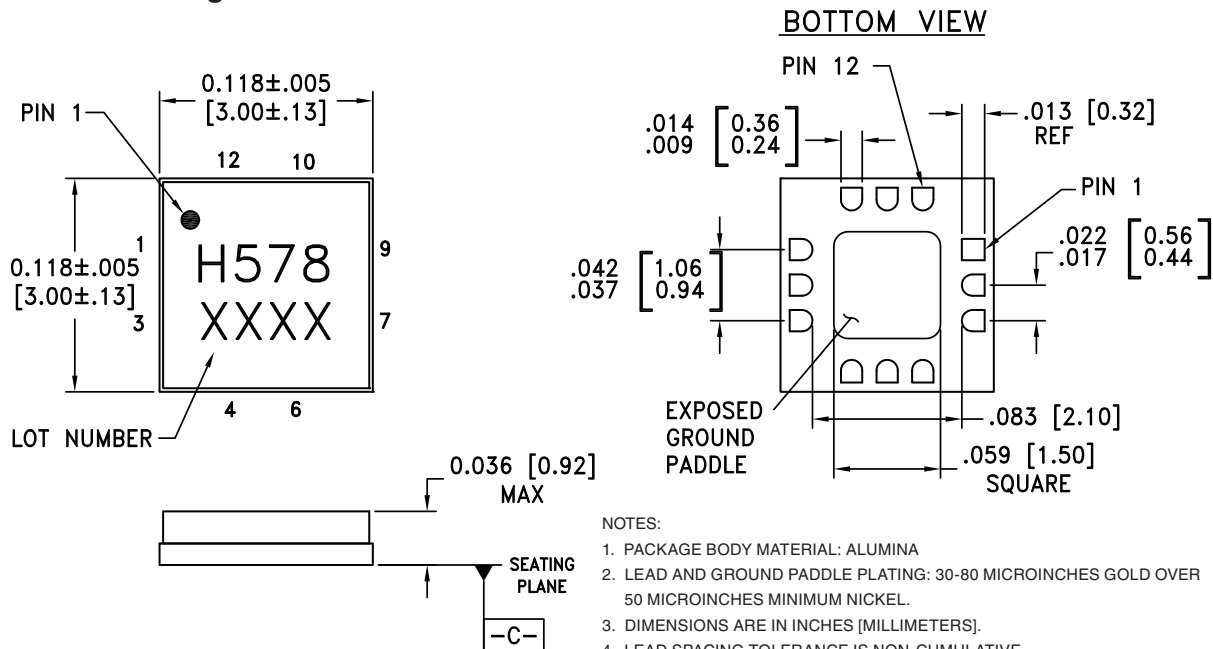

ELECTROSTATIC SENSITIVE DEVICE
OBSERVE HANDLING PRECAUTIONS

Outline Drawing

Package Information

Part Number	Package Body Material	Lead Finish	MSL Rating	Package Marking ^[2]
HMC578LC3B	Alumina, White	Gold over Nickel	MSL3 ^[1]	H578 XXXX

[1] Max peak reflow temperature of 260 °C

[2] 4-Digit lot number XXXX



SMT GaAs MMIC x2 ACTIVE FREQUENCY MULTIPLIER, 23 - 33 GHz

Pin Description

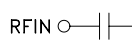
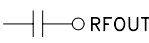
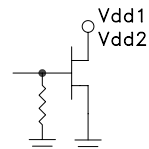
Pin Number	Function	Description	Interface Schematic
1, 3, 7, 9	GND	Package bottom must also be connected to RF/DC ground.	
2	RFIN	Pin is AC coupled and matched to 50 Ohms.	
4 - 6, 11	N/C	These pins are internally not connected; however, this product was specified with these pins connected to RF/ DC ground.	
8	RFOUT	Pin is AC coupled and matched to 50 Ohms.	
10, 12	Vdd2, Vdd1	Supply voltage 5V ± 0.5V. External bypass capacitors of 100 pF, 1,000 pF and 2.2 μF are required.	

Application Circuit

Component	Value
C1, C2	100 pF
C3, C4	1,000 pF
C5, C6	2.2 μF

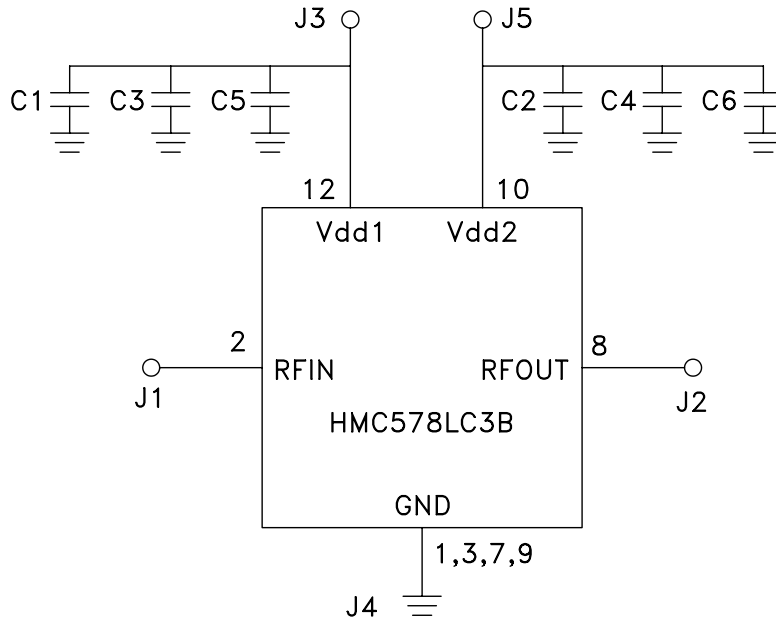

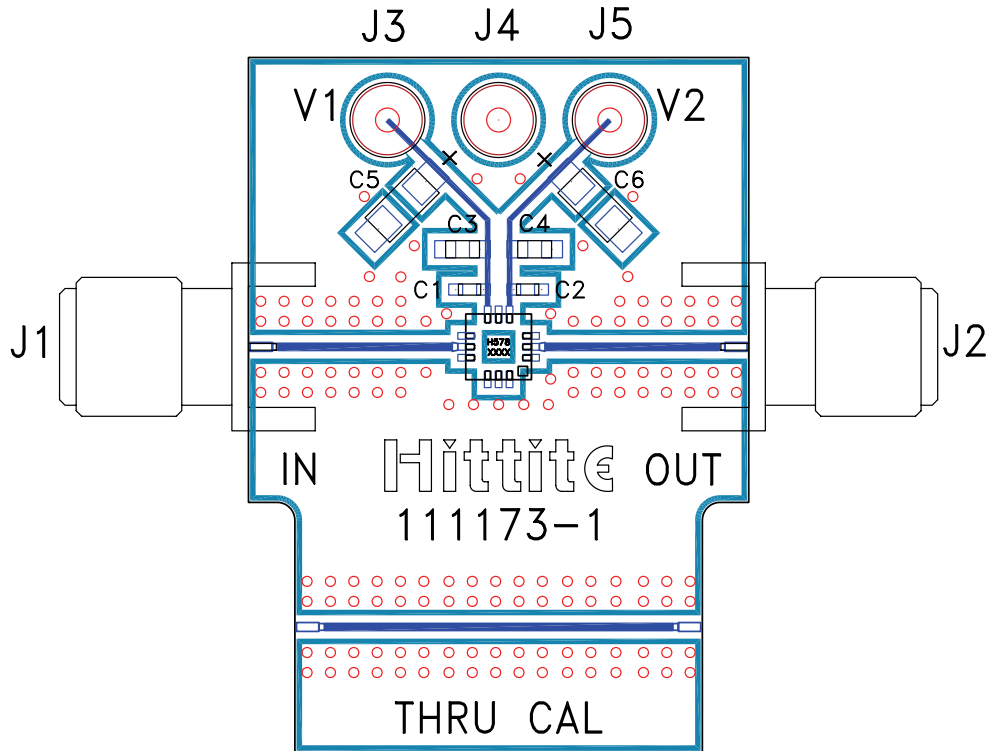
Evaluation PCB

List of Materials for Evaluation PCB 112409 [1]

Item	Description
J1, J2	PCB Mount SRI K Connector
J3 - J5	DC Pin
C1, C2	100 pF Capacitor, 0402 Pkg.
C3, C4	1,000 pF Capacitor, 0603 Pkg.
C5, C6	2.2 μ F Tantalum Capacitor
U1	HMC578LC3B x2 Active Multiplier
PCB [2]	111173 Eval Board

[1] Reference this number when ordering complete evaluation PCB

[2] Circuit Board Material: Rogers 4350

The circuit board used in the final application should be generated with proper RF circuit design techniques. Signal lines should have 50 ohm impedance while the package ground leads and exposed paddle should be connected directly to the ground plane similar to that shown. A sufficient number of via holes should be used to connect the top and bottom ground planes. The evaluation circuit board shown is available from Hittite upon request.

Данный компонент на территории Российской Федерации

Вы можете приобрести в компании MosChip.

Для оперативного оформления запроса Вам необходимо перейти по данной ссылке:

<http://moschip.ru/get-element>

Вы можете разместить у нас заказ для любого Вашего проекта, будь то серийное производство или разработка единичного прибора.

В нашем ассортименте представлены ведущие мировые производители активных и пассивных электронных компонентов.

Нашей специализацией является поставка электронной компонентной базы двойного назначения, продукции таких производителей как XILINX, Intel (ex.ALTERA), Vicor, Microchip, Texas Instruments, Analog Devices, Mini-Circuits, Amphenol, Glenair.

Сотрудничество с глобальными дистрибьюторами электронных компонентов, предоставляет возможность заказывать и получать с международных складов практически любой перечень компонентов в оптимальные для Вас сроки.

На всех этапах разработки и производства наши партнеры могут получить квалифицированную поддержку опытных инженеров.

Система менеджмента качества компании отвечает требованиям в соответствии с ГОСТ Р ИСО 9001, ГОСТ РВ 0015-002 и ЭС РД 009

Офис по работе с юридическими лицами:

105318, г.Москва, ул.Щербаковская д.3, офис 1107, 1118, ДЦ «Щербаковский»

Телефон: +7 495 668-12-70 (многоканальный)

Факс: +7 495 668-12-70 (доб.304)

E-mail: info@moschip.ru

Skype отдела продаж:

moschip.ru

moschip.ru_4

moschip.ru_6

moschip.ru_9