

1. Features and Benefits

- Wide operating voltage range: from 2.7V to 24V
- Integrated self-diagnostic functions activating dedicated Safe Mode
- Reverse supply voltage protection
- Under-Voltage Lockout protection
- Integrated capacitor for PCB less designs
- HW component Qualified according to ISO26262-8:13 for use in safety critical systems.

2. Application Examples

- Automotive, Consumer and Industrial
- Brake light switch
- Window lifter
- Door lock
- Seatbelt buckle
- Seat positioning
- Transmission applications
- Electrical power steering

3. Ordering Information

Product Code	Temperature Code	Package Code	Option Code	Packing Form Code
MLX92241	L	UA	BAA-0xx	BU
MLX92241	L	SE	BAA-0xx	RE
MLX92241	L	UA	BAA-1xx	BU
MLX92241	L	SE	BAA-2xx	RE
MLX92241	L	UA	BAA-3xx	BU

Legend:

Temperature Code: L(-40°C to 150°C)
Package Code: UA = TO92-3L | SE = TSOT-3L
Option Code: 0xx => Perpendicular sensitive
1xx => Integrated capacitor (UA package only)
2xx => IMC (SE package only)
3xx => Integrated capacitor and IMC (UA package only)
Packing Form: BU = Bulk | RE = Reel | CA=Papertape in Ammopack | CR=Papertape on Reel
Ordering example: MLX92241LUA-BAA-1xx-BU

4. Functional Diagram

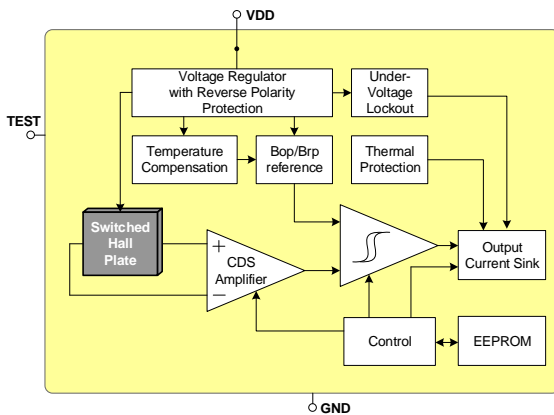

5. General Description

The Melexis MLX92241 is based on the Melexis Hall-effect latest platform, designed in mixed signal submicron CMOS technology.

The device integrates a voltage regulator, Hall sensor with advanced offset cancellation system and a current sink-configured output driver and integrated capacitor all in a single package.

Based on the proven in use platform, the magnetic core is using an improved offset cancellation system allowing faster and more accurate processing while being temperature insensitive and stress independent. In addition a pre-programmable temperature coefficient is implemented to compensate the natural behavior of certain types of magnets becoming weaker with rise in temperature.

The included voltage regulator operates from 2.7 to 24V, hence covering a wide range of applications. With the built-in reverse voltage protection, a serial resistor or diode on the supply line is not required so that even remote sensors can be specified for low voltage operation down to 2.7V while being reverse voltage tolerant.

In an event of a drop below the minimum supply voltage during operation, the under-voltage lock-out protection will automatically freeze the device, preventing the electrical perturbation to affect the magnetic measurement circuitry. The output current state is therefore only updated based on a proper and accurate magnetic measurement result.

The two-wire interface not only saves one wire, but also allows implementation of diagnostic functions as reverse polarity connection and malfunction detection.

The on-chip thermal protection also switches off the output if the junction temperature increases above an abnormally high threshold. It will automatically recover once the temperature decreases below a safe value.

The MLX92241 is delivered in a Green and RoHS compliant Plastic Single-in-Line (TO-92) for through-hole mount, or PCB-less design with integrated capacitor or in 3-pin Thin Small Outline Transistor (TSOT) for surface mount process.

Contents

1. Features and Benefits	1
2. Application Examples	1
3. Ordering Information	1
4. Functional Diagram	2
5. General Description	2
6. Glossary of Terms	5
7. Absolute Maximum Ratings	5
8. General Electrical Specifications	6
9. Magnetic Specifications	7
9.1. MLX92241LSE-BAA-007	7
9.2. MLX92241LSE-BAA-019	7
9.3. MLX92241LSE-BAA-021	7
9.4. MLX92241LSE-BAA-023	8
9.5. MLX92241LSE-BAA-024	8
9.6. MLX92241LSE-BAA-025	8
9.7. MLX92241LSE-BAA-027	9
9.8. MLX92241LUA-BAA-101	9
9.9. MLX92241LUA-BAA-103	9
9.10. MLX92241LUA-BAA-106	10
9.11. MLX92241LUA-BAA-107	10
9.12. MLX92241LUA-BAA-108	10
9.13. MLX92241LUA-BAA-110	10
9.14. MLX92241LUA-BAA-111	11
9.15. MLX92241LUA-BAA-112	11
9.16. MLX92241LUA-BAA-113	11
9.17. MLX92241LUA-BAA-114	12
9.18. MLX92241LSE-BAA-032	12
9.19. MLX92241LUA-BAA-033	12
9.20. MLX92241LSE-BAA-034	12
10. Magnetic Behavior	14
11. Application Information	15

- 11.1. Typical Automotive Application Circuit..... 15
- 11.2. Automotive and Harsh, Noisy Environments Application Circuit 15
- 11.3. Power Derating Curve..... 16
- 11.4. Voltage Derating Curve..... 16
- 12. Standard information regarding manufacturability of Melexis products with different soldering processes..... 17**
- 13. ESD Precautions..... 17**
- 14. Package Information..... 18**
 - 14.1. SE (TSOT-3L) Package Information 18
 - 14.2. UA (TO92 - 3L) Package Information..... 19
 - 14.3. UA (TO92 - 3L) with integrated capacitor Package Information 20
- 15. Contact 21**
- 16. Disclaimer 21**

6. Glossary of Terms

Tesla	Units for the magnetic flux density, 1 mT = 10 Gauss
TC	Temperature Coefficient in ppm/°C
NC	Not Connected
POR	Power on Reset
IMC	integrated magnetic concentrator (lateral sensing)

7. Absolute Maximum Ratings

Exceeding the absolute maximum ratings may cause permanent damage. Exposure to absolute maximum rated conditions for extended periods may affect device reliability.

Parameter	Symbol	Value	Units
Supply Voltage ^(1, 2)	V _{DD}	+28	V
Supply Voltage (Load Dump) ^(1, 4)	V _{DD}	+32	V
Supply Current ^(1, 2, 3)	I _{DD}	+20	mA
Supply Current ^(1, 3, 4)	I _{DD}	+50	mA
Reverse Supply Voltage ^(1, 2)	V _{DDREV}	-24	V
Reverse Supply Voltage ^(1, 4)	V _{DDREV}	-30	V
Reverse Supply Current ^(1, 2, 5)	I _{DDREV}	-20	mA
Reverse Supply Current ^(1, 4, 5)	I _{DDREV}	-50	mA
Maximum Junction Temperature ⁽⁶⁾	T _J	+165	°C
ESD Sensitivity – HBM ⁽⁷⁾	-	8	kV
ESD Sensitivity – System level ⁽⁸⁾	-	15	kV
ESD Sensitivity – CDM ⁽⁹⁾	-	1000	V
Magnetic Flux Density	B	Unlimited	mT

¹ The maximum junction temperature should not be exceeded

² For maximum 1 hour

³ Including current through protection device

⁴ For maximum 500ms

⁵ Through protection device

⁶ For 1000 hours.

⁷ Human Model according AEC-Q100-002 standard

⁸ Indirect discharge according VW TL82466 standard, typical value, only for option MLX92241LUA-BAA-1xx

⁹ Charged Device Model according AEC-Q100-011 standard

8. General Electrical Specifications

DC Operating Parameters $V_{DD} = 2.7V$ to $24V$, $T_J = -40^{\circ}C$ to $165^{\circ}C$ (unless otherwise specified)

Parameter	Symbol	Test Conditions	Min	Typ ⁽¹⁾	Max	Units
OFF Supply Current (selectable by a dedicated bit)	I_{OFF}	$V_{DD} = 3.5$ to $24V$	2	-	5	mA
			5	-	6.9	
ON Supply Current	I_{ON}	$V_{DD} = 3.5$ to $24V$	12	-	17	mA
Reverse Supply current	I_{DDREV}	$V_{DD} = -16V$	-1	-	-	mA
Safe Mode Supply Current	I_{SAFE}		-	-	1	mA
Supply Current Rise/Fall Time ⁽²⁾	t_R/t_F	$V_{DD} = 12V$, $C_{LOAD}=50pF$ to GND	0.1	0.3	1	μs
Power-On Time ^(3, 4)	t_{ON}	$V_{DD} = 5V$, $dV_{DD}/dt > 2V/\mu s$, activated output with $>1mT$ overdrive	-	40	70	μs
Chopping Frequency	f_{CHOP}		-	350	-	kHz
Delay Time ^(2, 5)	t_D	Average over 1000 successive switching events @10kHz, Latch, B_{OP} set to 5mT, triangle wave magnetic field with $B>\pm 20mT$	-	7.5	-	μs
Output Jitter (p-p) ^(2, 6)	t_{JITTER}	Over 1000 successive switching events @10kHz, Latch, B_{OP} set to 5mT, triangle wave magnetic field with $B>\pm 20mT$	-	± 3.5	-	μs
Maximum Switching Frequency ^(2, 7)	f_{SW}	Latch, B_{OP} set to 5mT, triangle wave magnetic field with $B>\pm 20mT$	-	50	-	kHz
Under-voltage Lockout Threshold	V_{UVL}		-	-	2.7	V
Under-voltage Lockout Reaction time ⁽²⁾	t_{UVL}		-	1	-	μs
Integrated bypass capacitor	C_{BP}	Only for option MLX92241LUA- BAA-1xx	-	68	-	nF
Thermal Protection Activation	T_{PROT}	Junction Temperature	-	190 ⁽⁸⁾	-	$^{\circ}C$
Thermal Protection Release	T_{REL}	Junction Temperature	-	180 ⁽⁸⁾	-	$^{\circ}C$
UA Package Thermal Resistance	R_{THJA}	Single layer PCB, JEDEC standard test boards	-	200	-	$^{\circ}C/W$
SE Package Thermal Resistance	R_{THJA}	Single layer PCB, JEDEC standard test boards	-	300	-	$^{\circ}C/W$

1 Typical values are defined at $T_A=25^{\circ}C$ and $V_{DD}=12V$

2 Guaranteed by design and verified by characterization, not production tested

3 The Power-On Time represents the time from reaching $V_{DD}=2.7V$ to the first refresh of the supply current state

4 Power-On Slew Rate is not critical for the proper device start-up

5 The Delay Time is the time from magnetic threshold reached to the start of the output switching

6 Output jitter is the unpredictable deviation of the Delay time.

7 Maximum switching frequency corresponds to the maximum frequency of the applied magnetic field which is detected without loss of pulses

8 T_{PROT} and T_{REL} are the corresponding junction temperature values

9. Magnetic Specifications

9.1. MLX92241LSE-BAA-007

DC Operating Parameters $V_{DD} = 3.5V$ to $24V$, $T_J = -40^{\circ}C$ to $165^{\circ}C$

Test Condition	Operating Point B_{OP} (mT)			Release Point B_{RP} (mT)			TC (ppm/ $^{\circ}C$)	Ioff (mA)	Output Behavior Active Pole	Package Information
	Min	Typ ⁽¹⁾	Max	Min	Typ ⁽¹⁾	Max				
$T_J = -40^{\circ}C$	13.4	16	19	12.4	15	18.1	-1100 ⁽²⁾	3.3	Z-axis sensitive South pole Direct Switch	SE (TSOT-3L)
$T_J = 25^{\circ}C$	13.2	15	16.8	12.2	14	15.8				
$T_J = 150^{\circ}C$	10.1	13	16.1	9	12	15.1				

9.2. MLX92241LSE-BAA-019

DC Operating Parameters $V_{DD} = 3.5V$ to $24V$, $T_J = -40^{\circ}C$ to $165^{\circ}C$

Test Condition	Operating Point B_{OP} (mT)			Release Point B_{RP} (mT)			TC (ppm/ $^{\circ}C$)	Ioff (mA)	Output Behavior Active Pole	Package Information
	Min	Typ ⁽¹⁾	Max	Min	Typ ⁽¹⁾	Max				
$T_J = -40^{\circ}C$	6	9.2	12	5	7.2	10.5	0 ⁽²⁾	3.3	Z-axis sensitive South pole Inverted Switch	SE (TSOT-3L)
$T_J = 25^{\circ}C$	6	9.2	12	5	7.2	10.5				
$T_J = 150^{\circ}C$	5.7	9.2	12.5	4.6	7.2	11				

9.3. MLX92241LSE-BAA-021

DC Operating Parameters $V_{DD} = 3.5V$ to $24V$, $T_J = -40^{\circ}C$ to $165^{\circ}C$

Test Condition	Operating Point B_{OP} (mT)			Release Point B_{RP} (mT)			TC (ppm/ $^{\circ}C$)	Ioff (mA)	Output Behavior Active Pole	Package Information
	Min	Typ ⁽¹⁾	Max	Min	Typ ⁽¹⁾	Max				
$T_J = -40^{\circ}C$	6	9.2	12	5	7.2	10.5	0 ⁽²⁾	6	Z-axis sensitive South pole Inverted Switch	SE (TSOT-3L)
$T_J = 25^{\circ}C$	6	9.2	12	5	7.2	10.5				
$T_J = 150^{\circ}C$	5.7	9.2	12.5	4.6	7.2	11				

¹ Typical values are defined at $T_A = +25^{\circ}C$ and $V_{DD} = 12V$

² Temperature coefficient is calculated using the following formula:

$$\frac{B_{OPT2} - B_{OPT1}}{B_{OP25^{\circ}C}} \times (T_2 - T_1) \times 10^6, \text{ ppm}/^{\circ}C; T_1 = 25^{\circ}C; T_2 = 150^{\circ}C$$

9.4. MLX92241LSE-BAA-023

DC Operating Parameters $V_{DD} = 3.5V$ to $24V$, $T_J = -40^{\circ}C$ to $165^{\circ}C$

Test Condition	Operating Point B_{OP} (mT)			Release Point B_{RP} (mT)			TC (ppm/ $^{\circ}C$)	I_{off} (mA)	Output Behavior Active Pole	Package Information
	Min	Typ ⁽¹⁾	Max	Min	Typ ⁽¹⁾	Max				
$T_J = -40^{\circ}C$	-10.9	-8.5	-5.9	-7.9	-5.5	-3.5	-1100 ⁽²⁾	6	Z-axis sensitive North pole Direct Switch	SE (TSOT-3L)
$T_J = 25^{\circ}C$	-9.5	-7.9	-6.1	-7	-5.3	-3.9				
$T_J = 150^{\circ}C$	-9.6	-6.8	-3.8	-8.2	-5	-2.7				

9.5. MLX92241LSE-BAA-024

DC Operating Parameters $V_{DD} = 3.5V$ to $24V$, $T_J = -40^{\circ}C$ to $165^{\circ}C$

Test Condition	Operating Point B_{OP} (mT)			Release Point B_{RP} (mT)			TC (ppm/ $^{\circ}C$)	I_{off} (mA)	Output Behavior Active Pole	Package Information
	Min	Typ ⁽¹⁾	Max	Min	Typ ⁽¹⁾	Max				
$T_J = -40^{\circ}C$	6.5	8.7	11	5.2	7.3	9.8	0 ⁽²⁾	6	Z-axis sensitive South pole Inverted Switch	SE (TSOT-3L)
$T_J = 25^{\circ}C$	6.5	8.7	11	5.2	7.3	9.8				
$T_J = 85^{\circ}C$	6.5	8.7	11	5.2	7.3	9.8				
$T_J = 150^{\circ}C$	6.2	8.7	11.5	4.8	7.3	10.3				

9.6. MLX92241LSE-BAA-025

DC Operating Parameters $V_{DD} = 3.5V$ to $24V$, $T_J = -40^{\circ}C$ to $165^{\circ}C$

Test Condition	Operating Point B_{OP} (mT) ⁽³⁾			Release Point B_{RP} (mT) ⁽³⁾			TC (ppm/ $^{\circ}C$)	I_{off} (mA)	Output Behavior Active Pole	Package Information
	Min	Typ ⁽¹⁾	Max	Min	Typ ⁽¹⁾	Max				
$T_J = -40^{\circ}C$	-9	-6.4	-4	-6.5	-4.3	-2	-1100 ⁽²⁾	6	Z-axis sensitive North pole Direct Switch	SE (TSOT-3L)
$T_J = 25^{\circ}C$	-8	-6	-4	-6	-4	-2				
$T_J = 150^{\circ}C$	-7.5	-5.2	-3	-5.6	-3.5	-1.5				

¹ Typical values are defined at $T_A = +25^{\circ}C$ and $V_{DD} = 12V$

² Temperature coefficient is calculated using the following formula:

$$\frac{B_{OPT2} - B_{OPT1}}{B_{OP25^{\circ}C}} * 10^6, ppm/^{\circ}C; T_1 = 25^{\circ}C; T_2 = 150^{\circ}C$$

³ Final magnetic parameters will be covered in the PPAP documentation set, the table below is based on theoretical calculations

9.7. MLX92241LSE-BAA-027

DC Operating Parameters $V_{DD} = 3.5V$ to $24V$, $T_J = -40^{\circ}C$ to $165^{\circ}C$

Test Condition	Operating Point B_{OP} (mT)			Release Point B_{RP} (mT)			TC (ppm/ $^{\circ}C$)	Ioff (mA)	Output Behavior Active Pole	Package Information
	Min	Typ ⁽¹⁾	Max	Min	Typ ⁽¹⁾	Max				
$T_J = -40^{\circ}C$	9	11.5	14.5	2.8	4.6	6.4	-2000 ⁽²⁾	3.3	Z-axis sensitive South pole Direct Switch	SE (TSOT-3L)
$T_J = 25^{\circ}C$	8	10	12.3	2.5	4	5.6				
$T_J = 150^{\circ}C$	5.5	7.5	9.7	1.4	3	4.6				

9.8. MLX92241LUA-BAA-101

DC Operating Parameters $V_{DD} = 3.5V$ to $24V$, $T_J = -40^{\circ}C$ to $165^{\circ}C$

Test Condition	Operating Point B_{OP} (mT) ⁽³⁾			Release Point B_{RP} (mT) ⁽³⁾			TC (ppm/ $^{\circ}C$)	Ioff (mA)	Output Behavior Active Pole	Package Information
	Min	Typ ⁽¹⁾	Max	Min	Typ ⁽¹⁾	Max				
$T_J = -40^{\circ}C$	12	17	22.8	11.4	15.4	21.4	0 ⁽²⁾	6	Z-axis sensitive South pole Inverted Switch	UA (T092-3L)
$T_J = 25^{\circ}C$	14.5	17	19.5	13	15.4	17.8				
$T_J = 150^{\circ}C$	12	17	22.8	11.4	15.4	21.4				

9.9. MLX92241LUA-BAA-103

DC Operating Parameters $V_{DD} = 3.5V$ to $24V$, $T_J = -40^{\circ}C$ to $165^{\circ}C$

Test Condition	Operating Point B_{OP} (mT) ⁽³⁾			Release Point B_{RP} (mT) ⁽³⁾			TC (ppm/ $^{\circ}C$)	Ioff (mA)	Output Behavior Active Pole	Package Information
	Min	Typ ⁽¹⁾	Max	Min	Typ ⁽¹⁾	Max				
$T_J = -40^{\circ}C$	4.4	6.4	8.7	2.2	4.3	6.3	-1100 ⁽²⁾	3.3	Z-axis sensitive South pole Inverted Switch	UA (T092-3L)
$T_J = 25^{\circ}C$	4.4	6.0	7.6	2.3	4	5.5				
$T_J = 150^{\circ}C$	3.1	5.2	7.5	1.6	3.5	5.6				

¹ Typical values are defined at $T_A = +25^{\circ}C$ and $V_{DD} = 12V$

² Temperature coefficient is calculated using the following formula:

$$\frac{B_{OPT2} - B_{OPT1}}{B_{OP25^{\circ}C}} \times (T_2 - T_1) * 10^6, ppm / ^{\circ}C; T_1 = 25^{\circ}C; T_2 = 150^{\circ}C$$

³ Final magnetic parameters will be covered in the PPAP documentation set, the table below is based on theoretical calculations

9.10. MLX92241LUA-BAA-106

DC Operating Parameters $V_{DD} = 3.5V$ to $24V$, $T_J = -40^{\circ}C$ to $165^{\circ}C$

Test Condition	Operating Point B_{OP} (mT) ⁽³⁾			Release Point B_{RP} (mT) ⁽³⁾			TC (ppm/°C)	Ioff (mA)	Output Behavior Active Pole	Package Information
	Min	Typ ⁽¹⁾	Max	Min	Typ ⁽¹⁾	Max				
$T_J = -40^{\circ}C$	2	4	6	1	2.7	5.5	0 ⁽²⁾	6	Z-axis sensitive South pole Direct Switch	UA (T092-3L)
$T_J = 25^{\circ}C$	2	4	6	1	2.7	5.5				
$T_J = 150^{\circ}C$	2	4	6	1	2.7	5.5				

9.11. MLX92241LUA-BAA-107

DC Operating Parameters $V_{DD} = 3.5V$ to $24V$, $T_J = -40^{\circ}C$ to $165^{\circ}C$

Test Condition	Operating Point B_{OP} (mT)			Release Point B_{RP} (mT)			TC (ppm/°C)	Ioff (mA)	Output Behavior Active Pole	Package Information
	Min	Typ ⁽¹⁾	Max	Min	Typ ⁽¹⁾	Max				
$T_J = -40^{\circ}C$	2.7	4.3	5.9	1.7	3.3	5	-1100 ⁽²⁾	6	Z-axis sensitive South pole Inverted Switch	UA (T092-3L)
$T_J = 25^{\circ}C$	2.8	4	5.2	1.8	3	4.2				
$T_J = 150^{\circ}C$	1.9	3.5	5.3	0.8	2.5	4.3				

9.12. MLX92241LUA-BAA-108

DC Operating Parameters $V_{DD} = 3.5V$ to $24V$, $T_J = -40^{\circ}C$ to $165^{\circ}C$

Test Condition	Operating Point B_{OP} (mT)			Release Point B_{RP} (mT)			TC (ppm/°C)	Ioff (mA)	Output Behavior Active Pole	Package Information
	Min	Typ ⁽¹⁾	Max	Min	Typ ⁽¹⁾	Max				
$T_J = -40^{\circ}C$	5.8	8.5	10.9	3.5	5.6	8	-1100 ⁽²⁾	3.3	Z-axis sensitive South pole Direct Switch	UA (T092-3L)
$T_J = 25^{\circ}C$	5.8	7.9	9.5	3.6	5.2	7				
$T_J = 150^{\circ}C$	3.6	6.6	9.6	2.1	4.4	8.2				

9.13. MLX92241LUA-BAA-110

DC Operating Parameters $V_{DD} = 3.5V$ to $24V$, $T_J = -40^{\circ}C$ to $165^{\circ}C$

Test Condition	Operating Point B_{OP} (mT)			Release Point B_{RP} (mT)			TC (ppm/°C)	Ioff (mA)	Output Behavior Active Pole	Package Information
	Min	Typ ⁽¹⁾	Max	Min	Typ ⁽¹⁾	Max				
$T_J = -40^{\circ}C$	5.9	8.5	10.9	3.5	5.5	7.9	-1100 ⁽²⁾	6	Z-axis sensitive South pole Direct Switch	UA (T092-3L)
$T_J = 25^{\circ}C$	6.1	7.9	9.5	3.9	5.3	7				
$T_J = 150^{\circ}C$	3.8	6.8	9.6	2.7	5	8.2				

¹ Typical values are defined at $T_A = +25^{\circ}C$ and $V_{DD} = 12V$

² Temperature coefficient is calculated using the following formula:

$$\frac{B_{OPT2} - B_{OPT1}}{B_{OP25^{\circ}C}} * 10^6, ppm/^{\circ}C; T_1 = 25^{\circ}C; T_2 = 150^{\circ}C$$

³ Final magnetic parameters will be covered in the PPAP documentation set, the table below is based on theoretical calculations

9.14. MLX92241LUA-BAA-111

DC Operating Parameters $V_{DD} = 6V$ to $10V$, $T_J = -40^{\circ}C$ to $165^{\circ}C$

Test Condition	Operating Point B_{OP} (mT)			Release Point B_{RP} (mT)			TC (ppm/ $^{\circ}C$)	Ioff (mA)	Output Behavior Active Pole	Package Information
	Min	Typ ⁽¹⁾	Max	Min	Typ ⁽¹⁾	Max				
$T_J = -40^{\circ}C$	2.4	3.9	5.5	1.4	2.7	4.1	0 ⁽²⁾	6	Z-axis sensitive South pole Direct Switch	UA (T092-3L)
$T_J = 25^{\circ}C$	2.5	3.8	5.1	1.5	2.6	3.7				
$T_J = 150^{\circ}C$	2	3.8	5.7	1	2.6	4.3				

9.15. MLX92241LUA-BAA-112

DC Operating Parameters $V_{DD} = 6V$ to $10V$, $T_J = -40^{\circ}C$ to $165^{\circ}C$

Test Condition	Operating Point B_{OP} (mT)			Release Point B_{RP} (mT)			TC (ppm/ $^{\circ}C$)	Ioff (mA)	Output Behavior Active Pole	Package Information
	Min	Typ ⁽¹⁾	Max	Min	Typ ⁽¹⁾	Max				
$T_J = -40^{\circ}C$	-5.5	-3.9	-2.4	-4.1	-2.7	-1.4	0 ⁽²⁾	6	Z-axis sensitive North pole Inverted Switch	UA (T092-3L)
$T_J = 25^{\circ}C$	-5.1	-3.8	-2.5	-3.7	-2.6	-1.5				
$T_J = 150^{\circ}C$	-5.7	-3.8	-2	-4.3	-2.6	-1				

9.16. MLX92241LUA-BAA-113

DC Operating Parameters $V_{DD} = 3.5V$ to $24V$, $T_J = -40^{\circ}C$ to $165^{\circ}C$

Test Condition	Operating Point B_{OP} (mT)			Release Point B_{RP} (mT)			TC (ppm/ $^{\circ}C$)	Ioff (mA)	Output Behavior Active Pole	Package Information
	Min	Typ ⁽¹⁾	Max	Min	Typ ⁽¹⁾	Max				
$T_J = -40^{\circ}C$	5.9	8.5	10.9	3.5	5.5	7.9	-1100 ⁽²⁾	3.3	Z-axis sensitive South pole Inverted Switch	UA (T092-3L)
$T_J = 25^{\circ}C$	6.1	7.9	9.5	3.9	5.3	7				
$T_J = 150^{\circ}C$	3.8	6.8	9.6	2.7	5	8.2				

1 Typical values are defined at $T_A = +25^{\circ}C$ and $V_{DD} = 12V$

2 Temperature coefficient is calculated using the following formula:

$$\frac{B_{OPT2} - B_{OPT1}}{B_{OP25^{\circ}C}} * 10^6, ppm / ^{\circ}C; T_1 = 25^{\circ}C; T_2 = 150^{\circ}C$$

9.17. MLX92241LUA-BAA-114

DC Operating Parameters $V_{DD} = 3.5V$ to $24V$, $T_J = -40^{\circ}C$ to $165^{\circ}C$

Test Condition	Operating Point B_{OP} (mT)			Release Point B_{RP} (mT)			TC (ppm/ $^{\circ}C$)	Ioff (mA)	Output Behavior Active Pole	Package Information
	Min	Typ ⁽¹⁾	Max	Min	Typ ⁽¹⁾	Max				
$T_J = -40^{\circ}C$	5.9	8.5	10.9	3.5	5.5	7.9	-1100 ⁽²⁾	6	Z-axis sensitive South pole Inverted Switch	UA (T092-3L)
$T_J = 25^{\circ}C$	6.1	7.9	9.5	3.9	5.3	7				
$T_J = 150^{\circ}C$	3.8	6.8	9.6	2.7	5	8.2				

9.18. MLX92241LSE-BAA-032

DC Operating Parameters $V_{DD} = 3.5V$ to $24V$, $T_J = -40^{\circ}C$ to $165^{\circ}C$

Test Condition	Operating Point B_{OP} (mT) ⁽³⁾			Release Point B_{RP} (mT) ⁽³⁾			TC (ppm/ $^{\circ}C$)	Ioff (mA)	Output Behavior Active Pole	Package Information
	Min	Typ ⁽¹⁾	Max	Min	Typ ⁽¹⁾	Max				
$T_J = -40^{\circ}C$	3.6	6	8.4	1.5	3.6	6.1	-1100 ⁽²⁾	3.3	Z-axis sensitive South pole Direct Switch	SE (TSOT-3L)
$T_J = 25^{\circ}C$	3.9	5.6	7.1	2	3.6	5.3				
$T_J = 150^{\circ}C$	2	4.8	7.1	1.3	3.5	6.7				

9.19. MLX92241LUA-BAA-033

DC Operating Parameters $V_{DD} = 3.5V$ to $24V$, $T_J = -40^{\circ}C$ to $165^{\circ}C$

Test Condition	Operating Point B_{OP} (mT) ⁽³⁾			Release Point B_{RP} (mT) ⁽³⁾			TC (ppm/ $^{\circ}C$)	Ioff (mA)	Output Behavior Active Pole	Package Information
	Min	Typ ⁽¹⁾	Max	Min	Typ ⁽¹⁾	Max				
$T_J = -40^{\circ}C$	17.5	21.4	25.9	15.4	19.4	24	-1100 ⁽²⁾	6	Z-axis sensitive South pole Direct Switch	UA (T092-3L)
$T_J = 25^{\circ}C$	17.1	20	23.1	15	18	21.2				
$T_J = 150^{\circ}C$	13.8	17.3	21.1	11.7	15.3	19.2				

9.20. MLX92241LSE-BAA-034

DC Operating Parameters $V_{DD} = 3.5V$ to $24V$, $T_J = -40^{\circ}C$ to $165^{\circ}C$

Test Condition	Operating Point B_{OP} (mT) ⁽³⁾			Release Point B_{RP} (mT) ⁽³⁾			TC (ppm/ $^{\circ}C$)	Ioff (mA)	Output Behavior Active Pole	Package Information
	Min	Typ ⁽¹⁾	Max	Min	Typ ⁽¹⁾	Max				
$T_J = -40^{\circ}C$	3.6	6	8.4	1.5	3.9	6.1	-1100 ⁽²⁾	6	Z-axis sensitive South pole Inverted Switch	SE (TSOT-3L)
$T_J = 25^{\circ}C$	3.9	5.5	7.1	2	3.5	5.3				
$T_J = 150^{\circ}C$	2	4.8	7.1	1.3	3	6.7				

¹ Typical values are defined at $T_A = +25^{\circ}C$ and $V_{DD} = 12V$

² Temperature coefficient is calculated using the following formula:

$$\frac{B_{OPT2} - B_{OPT1}}{B_{OP25^{\circ}C}} \times 10^6, \text{ ppm}/^{\circ}C; T_1 = 25^{\circ}C; T_2 = 150^{\circ}C$$

³ Final magnetic parameters will be covered in the PPAP documentation set, the table below is based on theoretical calculations

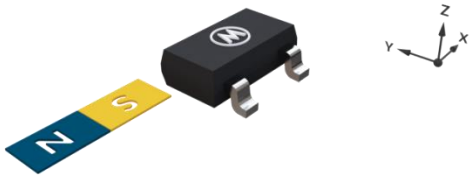

South active pole (IMC version)

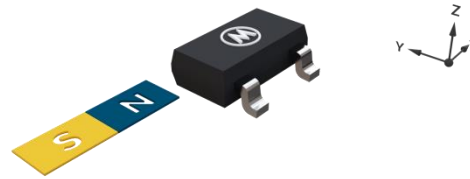

North active pole (IMC version)

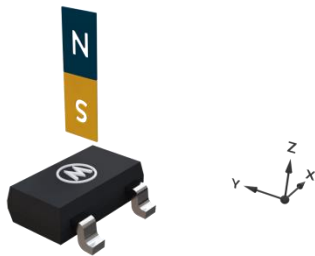

South active pole

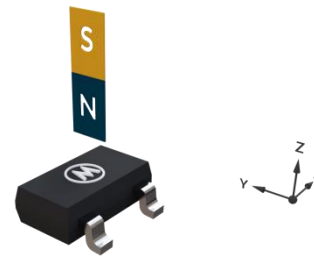

North active pole

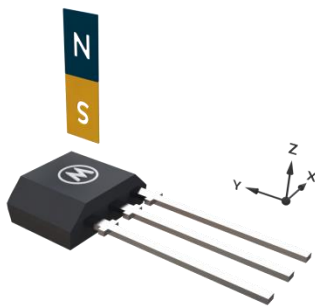

South active pole

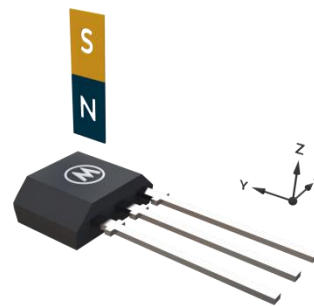

North active pole

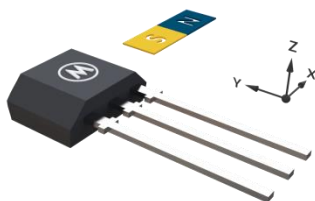

South active pole (IMC version)

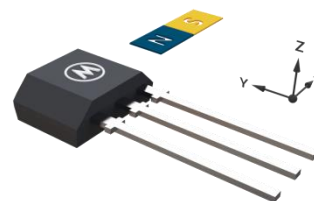

North active pole (IMC version)

10. Magnetic Behavior



Direct South Active Pole

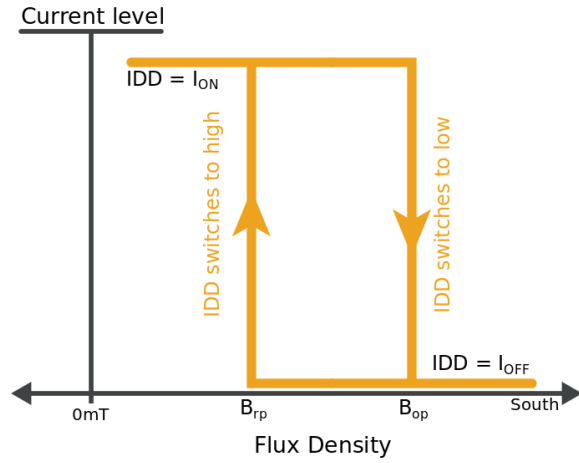

Inverted South Active Pole



Direct North Active Pole

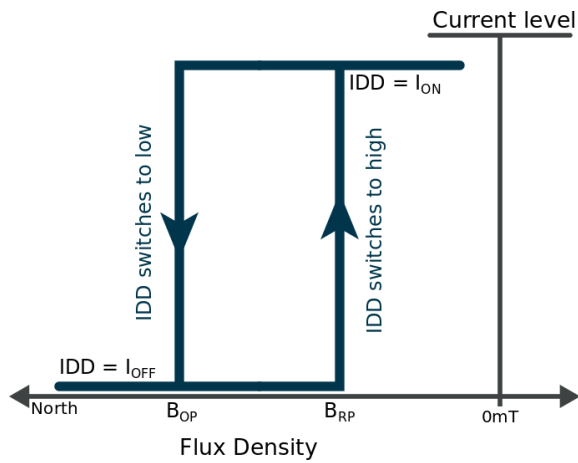

Inverted North Active Pole

11. Application Information

11.1. Typical Automotive Application Circuit



Notes:

1. For proper operation, a 10 to 100nF bypass capacitor should be placed as close as possible to the V_{DD} and ground (GND) pin. For MLX92241LUA-BAA-1xx C1 is not required.
2. The TEST pin is to be connected to GND or left open.

11.2. Automotive and Harsh, Noisy Environments Application Circuit



Notes:

1. For proper operation, a 10 to 100nF bypass capacitor should be placed as close as possible to the V_{DD} and ground (GND) pin. For MLX92241LUA-BAA-1xx C1 is not required.
2. The device can tolerate positive voltages up to +28 (+32)V and negative voltages down to -24 (-30)V. If bigger transients over the supply line are expected the usage of D1 and DZ1 (24...27V) is recommended. The series resistor R1 is used to limit the current through DZ1 and to improve the EMC performance.

11.3. Power Derating Curve



11.4. Voltage Derating Curve



12. Standard information regarding manufacturability of Melexis products with different soldering processes

Our products are classified and qualified regarding soldering technology, solderability and moisture sensitivity level according to following test methods:

Reflow Soldering SMD's (Surface Mount Devices)

- IPC/JEDEC J-STD-020

Moisture/Reflow Sensitivity Classification for Nonhermetic Solid State Surface Mount Devices (classification reflow profiles according to table 5-2)

- EIA/JEDEC JESD22-A113

Preconditioning of Nonhermetic Surface Mount Devices Prior to Reliability Testing (reflow profiles according to table 2)

Wave Soldering SMD's (Surface Mount Devices) and THD's (Through Hole Devices)

- EN60749-20

Resistance of plastic- encapsulated SMD's to combined effect of moisture and soldering heat

- EIA/JEDEC JESD22-B106 and EN60749-15

Resistance to soldering temperature for through-hole mounted devices

Iron Soldering THD's (Through Hole Devices)

- EN60749-15

Resistance to soldering temperature for through-hole mounted devices

Solderability SMD's (Surface Mount Devices) and THD's (Through Hole Devices)

- EIA/JEDEC JESD22-B102 and EN60749-21

Solderability

For all soldering technologies deviating from above mentioned standard conditions (regarding peak temperature, temperature gradient, temperature profile etc) additional classification and qualification tests have to be agreed upon with Melexis.

The application of Wave Soldering for SMD's is allowed only after consulting Melexis regarding assurance of adhesive strength between device and board.

Melexis recommends reviewing on our web site the General Guidelines [soldering recommendation](http://www.melexis.com/Quality_soldering.aspx) (http://www.melexis.com/Quality_soldering.aspx) as well as [trim&form recommendations](http://www.melexis.com/Assets/Trim-and-form-recommendations-5565.aspx) (<http://www.melexis.com/Assets/Trim-and-form-recommendations-5565.aspx>).

Melexis is contributing to global environmental conservation by promoting **lead free** solutions. For more information on qualifications of **RoHS** compliant products (RoHS = European directive on the Restriction Of the use of certain Hazardous Substances) please visit the quality page on our website:

<http://www.melexis.com/quality.aspx>

13. ESD Precautions

Electronic semiconductor products are sensitive to Electro Static Discharge (ESD).

Always observe Electro Static Discharge control procedures whenever handling semiconductor products.

14. Package Information

14.1. SE (TSOT-3L) Package Information

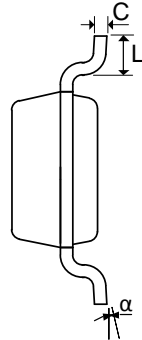
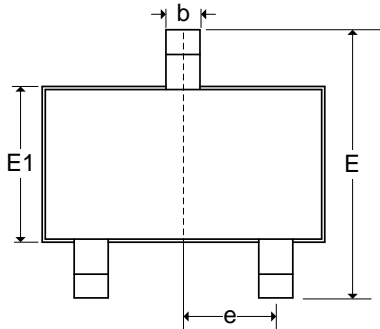

Notes:

1. All dimensions are in millimeters
2. Outermost plastic extreme width does not include mold flash or protrusions. Mold flash and protrusions shall not exceed 0.15mm per side.
3. Outermost plastic extreme length does not include mold flash or protrusions. Mold flash and protrusions shall not exceed 0.25mm per side.
4. The lead width dimension does not include dambar protrusion. Allowable dambar protrusion shall be 0.07mm total in excess of the lead width dimension at maximum material condition.
5. Dimension is the length of terminal for soldering to a substrate.
6. Formed lead shall be planar with respect to one another with 0.076mm at seating plane.

Marking:

TOP:

42WW

WW: Assembly week

BOTTOM:

YLLL

Y: Assembly Year

LLL: Last 3 digits from lot#

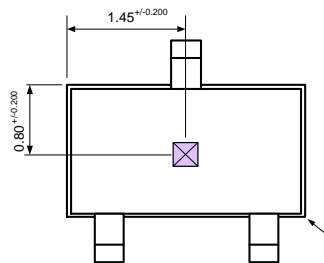
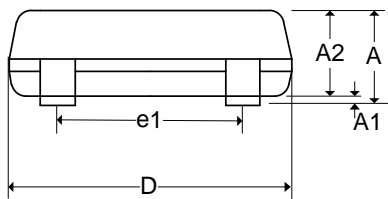

Hall plate location

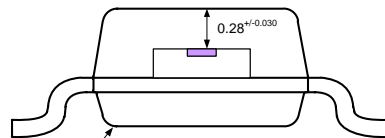

Notes:

1. All dimensions are in millimeters
2. XY Hall plate position tolerances do not include the mold flashes and protrusions described in the package drawing

TOP VIEW

END VIEW

	A	A1	A2	D	E	E1	L	b	c	e	e1	α
min	–	0.025	0.85	2.80	2.60	1.50	0.30	0.30	0.10	0.95	1.90	0°
max	1.00	0.10	0.90	3.00	3.00	1.70	0.50	0.45	0.20	BSC	BSC	8°

Notes:

1. Dimension “D” and “E1” do not include mold flash or protrusions. Mold flash or protrusion shall not exceed 0.15mm on “D” and 0.25mm on “E” per side.
2. Dimension “b” does not include dambar protrusion.

SE Pin №	Name	Type	Function
1	VDD	Supply	Supply Voltage pin
2	TEST	I/O	For Melexis use only
3	GND	Ground	Ground pin

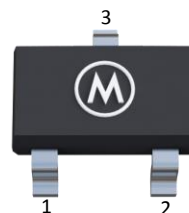

Table 4: SE Package pinout

14.2. UA (TO92 - 3L) Package Information



Hall plate location



	A	D	E	F	J	L	L1	S	b1	b2	c	e	e1
min	2.80	3.90	1.40	0.00	2.51	14.0	0.90	0.63	0.35	0.43	0.35	2.51	1.24
max	3.20	4.30	1.60	0.15	2.72	15.0	1.10	0.84	0.44	0.52	0.44	2.57	1.30
	theta1	theta2	theta3	theta4									
min	7°	7°	45°	7°									
max	REF	REF	REF	REF									

Notes:

1. All dimensions are in millimeters.
2. Mold flashes and protrusion are not included.
3. Gate burrs shall not exceed 0.127mm on the top side.

Pin №	Name	Type	Function
1	VDD	Supply	Supply Voltage pin
2	GND	Ground	Ground pin
3	TEST	I/O	For Melexis use only



14.3. UA (TO92 - 3L) with integrated capacitor Package Information



Notes:

1. All dimensions are in millimeters
2. Package dimension exclusive molding flash.
3. The end flash shall not exceed 0.127 mm on the top side.

Marking:

Top:

1st Line :

Option -1xx: C1WW, WW - calendar week

Option -3xx: C4WW, WW - calendar week

2nd Line : YLLL: → Y - last digit of year

LLL- Lot number (last 3 digits)



Hall plate location



Notes:

1. All dimensions are in millimeters

	A	D	E	F	J	L	L1	S	b1	b2	c	e	e1
min	2.80	3.90	1.40	0.00	2.51	14.0	0.90	0.63	0.35	0.43	0.35	2.51	1.24
max	3.20	4.30	1.60	0.15	2.72	15.0	1.10	0.84	0.44	0.52	0.44	2.57	1.30
	θ1	θ2	θ3	θ4									
min	7°	7°	45°	7°									
max	REF	REF	REF	REF									

Notes:

1. All dimensions are in millimeters.
2. Mold flashes and protrusion are not included.
3. Gate burrs shall not exceed 0.127mm on the top side.

Pin No	Name	Type	Function
1	VDD	Supply	Supply Voltage pin
2	TEST	I/O	For Melexis use only
3	GND	Ground	Ground pin



15. Contact

For the latest version of this document, go to our website at www.melexis.com.

For additional information, please contact our Direct Sales team and get help for your specific needs:

Europe, Africa	Telephone: +32 13 67 04 95
	Email : sales_europe@melexis.com
Americas	Telephone: +1 603 223 2362
	Email : sales_usa@melexis.com
Asia	Email : sales_asia@melexis.com

16. Disclaimer

The information furnished by Melexis herein ("Information") is believed to be correct and accurate. Melexis disclaims (i) any and all liability in connection with or arising out of the furnishing, performance or use of the technical data or use of the product(s) as described herein ("Product") (ii) any and all liability, including without limitation, special, consequential or incidental damages, and (iii) any and all warranties, express, statutory, implied, or by description, including warranties of fitness for particular purpose, non-infringement and merchantability. No obligation or liability shall arise or flow out of Melexis' rendering of technical or other services.

The Information is provided "as is" and Melexis reserves the right to change the Information at any time and without notice. Therefore, before placing orders and/or prior to designing the Product into a system, users or any third party should obtain the latest version of the relevant information to verify that the information being relied upon is current. Users or any third party must further determine the suitability of the Product for its application, including the level of reliability required and determine whether it is fit for a particular purpose.

The Information is proprietary and/or confidential information of Melexis and the use thereof or anything described by the Information does not grant, explicitly or implicitly, to any party any patent rights, licenses, or any other intellectual property rights.

This document as well as the Product(s) may be subject to export control regulations. Please be aware that export might require a prior authorization from competent authorities.

The Product(s) are intended for use in normal commercial applications. Unless otherwise agreed upon in writing, the Product(s) are not designed, authorized or warranted to be suitable in applications requiring extended temperature range and/or unusual environmental requirements. High reliability applications, such as medical life-support or life-sustaining equipment are specifically not recommended by Melexis.

The Product(s) may not be used for the following applications subject to export control regulations: the development, production, processing, operation, maintenance, storage, recognition or proliferation of 1) chemical, biological or nuclear weapons, or for the development, production, maintenance or storage of missiles for such weapons; 2) civil firearms, including spare parts or ammunition for such arms; 3) defense related products, or other material for military use or for law enforcement; 4) any applications that, alone or in combination with other goods, substances or organisms could cause serious harm to persons or goods and that can be used as a means of violence in an armed conflict or any similar violent situation.

The Products sold by Melexis are subject to the terms and conditions as specified in the Terms of Sale, which can be found at <https://www.melexis.com/en/legal/terms-and-conditions>.

This document supersedes and replaces all prior information regarding the Product(s) and/or previous versions of this document.

Melexis NV © - No part of this document may be reproduced without the prior written consent of Melexis. (2016)

ISO/TS 16949 and ISO14001 Certified

Данный компонент на территории Российской Федерации

Вы можете приобрести в компании MosChip.

Для оперативного оформления запроса Вам необходимо перейти по данной ссылке:

<http://moschip.ru/get-element>

Вы можете разместить у нас заказ для любого Вашего проекта, будь то серийное производство или разработка единичного прибора.

В нашем ассортименте представлены ведущие мировые производители активных и пассивных электронных компонентов.

Нашей специализацией является поставка электронной компонентной базы двойного назначения, продукции таких производителей как XILINX, Intel (ex.ALTERA), Vicor, Microchip, Texas Instruments, Analog Devices, Mini-Circuits, Amphenol, Glenair.

Сотрудничество с глобальными дистрибьюторами электронных компонентов, предоставляет возможность заказывать и получать с международных складов практически любой перечень компонентов в оптимальные для Вас сроки.

На всех этапах разработки и производства наши партнеры могут получить квалифицированную поддержку опытных инженеров.

Система менеджмента качества компании отвечает требованиям в соответствии с ГОСТ Р ИСО 9001, ГОСТ РВ 0015-002 и ЭС РД 009

Офис по работе с юридическими лицами:

105318, г.Москва, ул.Щербаковская д.3, офис 1107, 1118, ДЦ «Щербаковский»

Телефон: +7 495 668-12-70 (многоканальный)

Факс: +7 495 668-12-70 (доб.304)

E-mail: info@moschip.ru

Skype отдела продаж:

moschip.ru

moschip.ru_4

moschip.ru_6

moschip.ru_9