

MSG series

Rugged switch guards for switch series 12000 - 3500 - 600H - 6000



DISTINCTIVE FEATURES

Robust

For harsh environments

Modern, patented design



GENERAL SPECIFICATIONS

- APEM SAS patented design
- Operating temperature : -40 °C to +85 °C (-40 °F to +185 °F)
- Storage temperature : -55 °C to +85 °C (-67 °F to +185 °F)
- Salt spray : IEC 60068-2-11, test KA, 96 hours
- Mechanical life : 20,000 cycles
- Switch guards are designed to prevent accidental lever operation on switches with \varnothing 11.9 (.468) or \varnothing 12 (.472) threaded bushing and lever length 17.5 (.688) outside bushing.
When the guard is raised, the lever can be operated freely.
When the guard is fully depressed, the lever is reset/locked in a stable position.
Note : For correct switch operation, the switch guard should be adjusted properly (see "Mounting" below).



MATERIALS

- Support plate : black stainless steel
- Cap : thermoset

APEM products may be recycled at end-of-life for the re-claiming of valuable metal components.



PANEL CUT-OUT

FOR BUSHING WITH KEYWAY

FOR FLATTED BUSHING

K

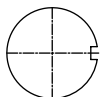

F

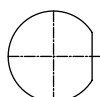

The company reserves the right to change specifications without notice.



MSG series

Rugged switch guards for switch series 12000 - 3500 - 600H - 6000



MOUNTING

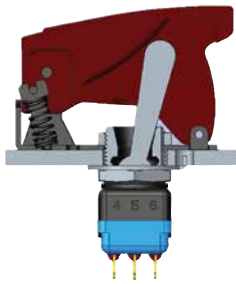

Standard



With K sealing option

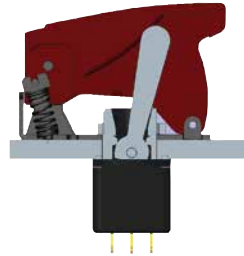

With X408 sealing option



BUILD YOUR PART NUMBER

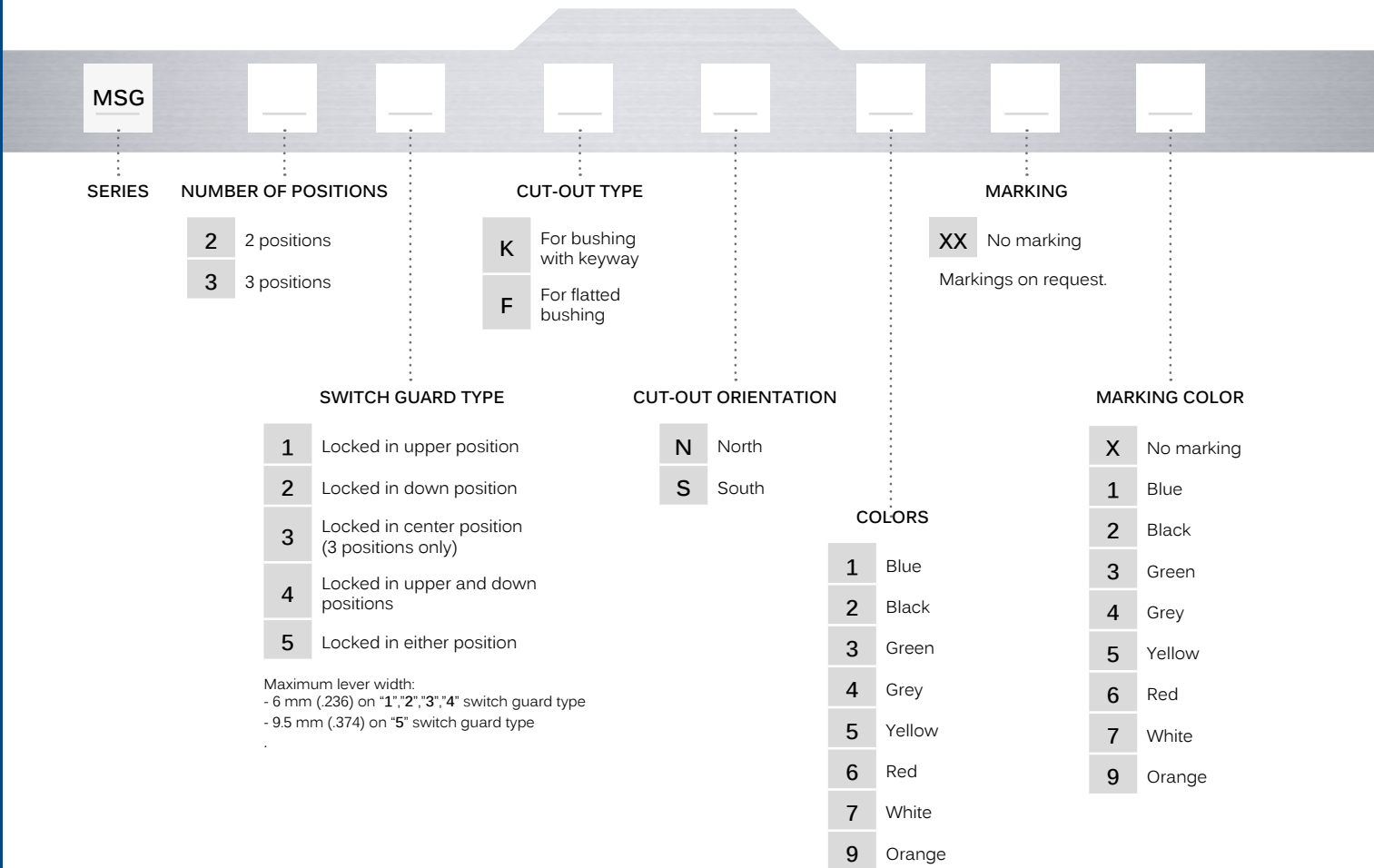

ABOUT THIS SERIES

On the following pages, you will find successively basic part numbers and options in the same order as in above chart.



Notice : please note that not all combinations of above numbers are available. Refer to the following pages for further information.



Mounting accessories : supplied with the switch or to order separately (see "Hardware" section of website).

MSG series

Rugged switch guards for switch series 12000 - 3500 - 600H - 6000

DIMENSIONS



Note : Ø 1.80 mm holes for wiring a seal are standard on all models.

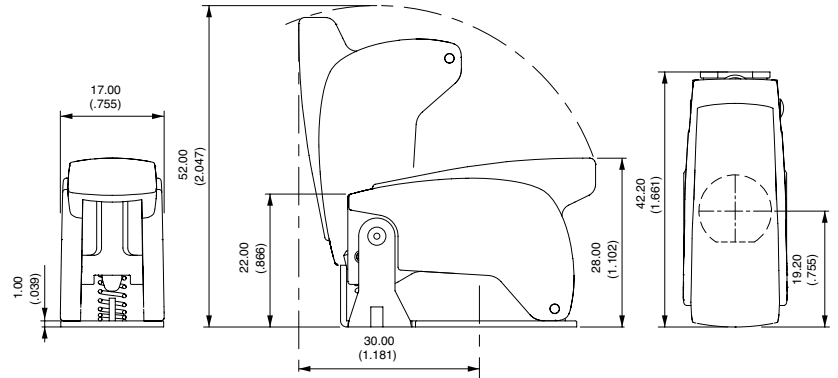

NUMBER OF POSITIONS

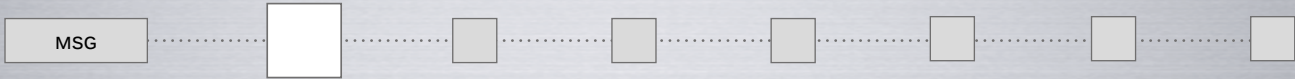

- 2 2 positions
- 3 3 positions

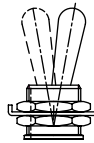

2



3

SWITCH GUARD TYPE

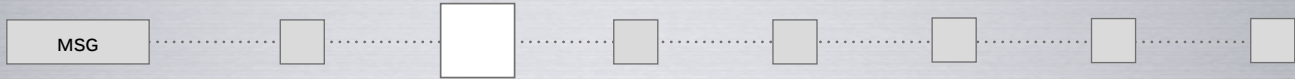

- 1 Locked in upper position
- 2 Locked in down position
- 3 Locked in center position (3 positions only)
- 4 Locked in upper and down positions
- 5 Locked in either position

Maximum lever width:

- 6 mm (.236) on "1","2","3","4" switch guard type
- 9.5 mm (.374) on "5" switch guard type



1

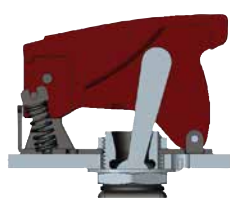

2

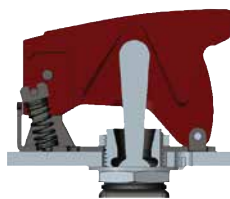

3

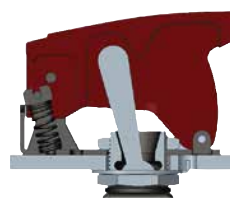

4

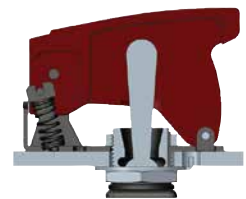

5

MSG series

Rugged switch guards for switch series 12000 - 3500 - 600H - 6000

CUT-OUT TYPE



- K For bushing with keyway
- F For flatted bushing



K



F

CUT-OUT ORIENTATION

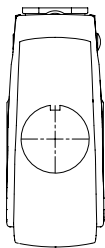

N

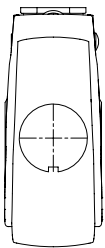

S

COLORS

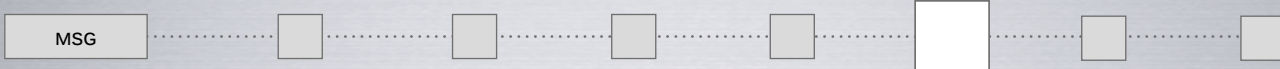

- 1 Blue
- 2 Black
- 3 Green
- 4 Grey
- 5 Yellow
- 6 Red
- 7 White
- 9 Orange



MARKING

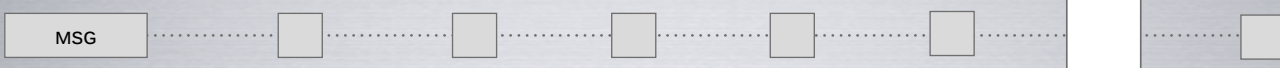

- XX No marking
- On request.

MARKING COLOR

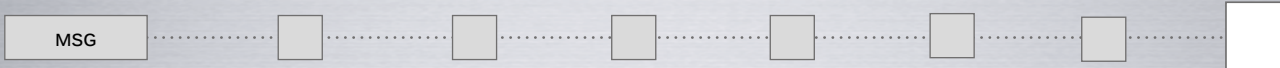

- | | | | | | |
|----|------------|---|--------|---|--------|
| XX | No marking | 3 | Green | 6 | Red |
| 1 | Blue | 4 | Grey | 7 | White |
| 2 | Black | 5 | Yellow | 9 | Orange |

Данный компонент на территории Российской Федерации

Вы можете приобрести в компании MosChip.

Для оперативного оформления запроса Вам необходимо перейти по данной ссылке:

<http://moschip.ru/get-element>

Вы можете разместить у нас заказ для любого Вашего проекта, будь то серийное производство или разработка единичного прибора.

В нашем ассортименте представлены ведущие мировые производители активных и пассивных электронных компонентов.

Нашей специализацией является поставка электронной компонентной базы двойного назначения, продукции таких производителей как XILINX, Intel (ex.ALTERA), Vicor, Microchip, Texas Instruments, Analog Devices, Mini-Circuits, Amphenol, Glenair.

Сотрудничество с глобальными дистрибьюторами электронных компонентов, предоставляет возможность заказывать и получать с международных складов практически любой перечень компонентов в оптимальные для Вас сроки.

На всех этапах разработки и производства наши партнеры могут получить квалифицированную поддержку опытных инженеров.

Система менеджмента качества компании отвечает требованиям в соответствии с ГОСТ Р ИСО 9001, ГОСТ РВ 0015-002 и ЭС РД 009

Офис по работе с юридическими лицами:

105318, г.Москва, ул.Щербаковская д.3, офис 1107, 1118, ДЦ «Щербаковский»

Телефон: +7 495 668-12-70 (многоканальный)

Факс: +7 495 668-12-70 (доб.304)

E-mail: info@moschip.ru

Skype отдела продаж:

moschip.ru

moschip.ru_4

moschip.ru_6

moschip.ru_9